

**NTP TECHNICAL REPORT**

**ON THE**

**TOXICOLOGY AND CARCINOGENESIS**

**STUDIES OF VINYLIDENE CHLORIDE**

**(CAS NO. 75-35-4)**

**IN F344/N RATS AND B6C3F1/N MICE**

**(INHALATION STUDIES)**

**Scheduled Peer Review Date: October 29, 2013**

NOTICE

This DRAFT Technical Report is distributed solely for the purpose of pre-dissemination peer review under the applicable information quality guidelines. It has not been formally disseminated by the NTP. It does not represent and should not be construed to represent NTP determination or policy.

**NTP TR 582**

**NIH Publication No. 14-5924**



**National Toxicology Program**

**National Institutes of Health**  
**Public Health Service**  
**U.S. DEPARTMENT OF HEALTH AND HUMAN SERVICES**

## FOREWORD

The National Toxicology Program (NTP) is an interagency program within the Public Health Service (PHS) of the Department of Health and Human Services (HHS) and is headquartered at the National Institute of Environmental Health Sciences of the National Institutes of Health (NIEHS/NIH). Three agencies contribute resources to the program: NIEHS/NIH, the National Institute for Occupational Safety and Health of the Centers for Disease Control and Prevention (NIOSH/CDC), and the National Center for Toxicological Research of the Food and Drug Administration (NCTR/FDA). Established in 1978, the NTP is charged with coordinating toxicological testing activities, strengthening the science base in toxicology, developing and validating improved testing methods, and providing information about potentially toxic substances to health regulatory and research agencies, scientific and medical communities, and the public.

The Technical Report series began in 1976 with carcinogenesis studies conducted by the National Cancer Institute. In 1981, this bioassay program was transferred to the NTP. The studies described in the Technical Report series are designed and conducted to characterize and evaluate the toxicologic potential, including carcinogenic activity, of selected substances in laboratory animals (usually two species, rats and mice). Substances selected for NTP toxicity and carcinogenicity studies are chosen primarily on the basis of human exposure, level of production, and chemical structure. The interpretive conclusions presented in NTP Technical Reports are based only on the results of these NTP studies. Extrapolation of these results to other species, including characterization of hazards and risks to humans, requires analyses beyond the intent of these reports. Selection *per se* is not an indicator of a substance's carcinogenic potential.

The NTP conducts its studies in compliance with its laboratory health and safety guidelines and FDA Good Laboratory Practice Regulations and must meet or exceed all applicable federal, state, and local health and safety regulations. Animal care and use are in accordance with the Public Health Service Policy on Humane Care and Use of Animals. Studies are subjected to retrospective quality assurance audits before being presented for public review.

NTP Technical Reports are indexed in the NIH/NLM PubMed database and are available free of charge electronically on the NTP website (<http://ntp.niehs.nih.gov>) or in hardcopy upon request from the NTP Central Data Management group at [cdm@niehs.nih.gov](mailto:cdm@niehs.nih.gov) or (919) 541-3419.

**NTP TECHNICAL REPORT**

**ON THE**

**TOXICOLOGY AND CARCINOGENESIS**

**STUDIES OF VINYLIDENE CHLORIDE**

**(CAS NO. 75-35-4)**

**IN F344/N RATS AND B6C3F1/N MICE**

**(INHALATION STUDIES)**

**Scheduled Peer Review Date: October 29, 2013**

NOTICE

This DRAFT Technical Report is distributed solely for the purpose of pre-dissemination peer review under the applicable information quality guidelines. It has not been formally disseminated by the NTP. It does not represent and should not be construed to represent NTP determination or policy.

**NTP TR 582**

**NIH Publication No. 14-5924**



**National Toxicology Program**

**National Institutes of Health**  
**Public Health Service**  
**U.S. DEPARTMENT OF HEALTH AND HUMAN SERVICES**

## CONTRIBUTORS

### National Toxicology Program

*Evaluated and interpreted results and reported findings*

M.E. Wyde, Ph.D., Study Scientist  
 M.J. Hoenerhoff, D.V.M., Ph.D., Study Pathologist  
 C.R. Blystone, M.S., Ph.D.  
 M.C. Cora, D.V.M.  
 P.M. Foster, Ph.D.  
 R.A. Herbert, D.V.M., Ph.D.  
 M.J. Hooth, Ph.D.  
 A.P. King-Herbert, D.V.M.  
 G.E. Kissling, Ph.D.  
 B.S. McIntyre, Ph.D.  
 D.E. Malarkey, D.V.M., Ph.D.  
 S.L. Smith-Roe, Ph.D.  
 M.D. Stout, Ph.D.  
 G.S. Travlos, D.V.M.  
 S. Waidyanatha, Ph.D.  
 N.J. Walker, Ph.D.  
 K.L. Witt, M.S.

### Battelle Toxicology Northwest

*Conducted studies and evaluated pathology findings*

J.A. Dill, Ph.D., Principal Investigator  
 S.L. Grumbein, D.V.M., Ph.D.  
 S.J. Harbo, D.V.M.  
 B.K. Hayden  
 B.A. Renne, D.V.M.

### Experimental Pathology Laboratories, Inc.

*Provided pathology review*

M.H. Hamlin, II, D.V.M., Principal Investigator  
 E.T. Adams, D.V.M., Ph.D.  
 H.M. Kolenda-Roberts, D.V.M., Ph.D.  
 R.A. Miller, D.V.M., Ph.D.  
 A.K.R. Pandiri, B.V.Sc. & A.H., Ph.D.

### Dynamac Corporation

*Prepared quality assessment audits*

S. Brecher, Ph.D., Principal Investigator  
 S. Iyer, B.S.  
 V.S. Tharakan, D.V.M.

### NTP Pathology Working Group

*Evaluated slides and contributed to pathology report on 2-year rats (December 14, 2010)*

R.M. Kovatch, D.V.M., Coordinator  
 Pathology Associates International, A Charles River Company  
 M.C. Boyle, D.V.M., Ph.D.  
 National Toxicology Program  
 S.A. Elmore, D.V.M., M.S.  
 National Toxicology Program  
 R.A. Herbert, D.V.M., Ph.D.  
 National Toxicology Program  
 M.J. Hoenerhoff, D.V.M., Ph.D.  
 National Toxicology Program  
 H.M. Kolenda-Roberts, D.V.M., Ph.D.  
 Experimental Pathology Laboratories, Inc.  
 L.L. Lanning, D.V.M.  
 National Institute of Allergy and Infectious Diseases  
 R.A. Miller, D.V.M., Ph.D.  
 Experimental Pathology Laboratories, Inc.  
 J.P. Morrison, D.V.M., Ph.D.  
 Pathology Associates International, A Charles River Company  
 A.B. Rogers, D.V.M., Ph.D.  
 University of North Carolina

### NTP Pathology Working Group

*Evaluated slides and contributed to pathology report on 2-year mice (August 19, 2010)*

R.M. Kovatch, D.V.M., Coordinator  
 Pathology Associates International, A Charles River Company  
 E.T. Adams, D.V.M., Ph.D.  
 Experimental Pathology Laboratories, Inc.  
 G.C. Hard, B.V.Sc., Ph.D., D.Sc.  
 Consultant  
 R.A. Herbert, D.V.M., Ph.D.  
 National Toxicology Program  
 M.J. Hoenerhoff, D.V.M., Ph.D.  
 National Toxicology Program  
 D.E. Malarkey, D.V.M., Ph.D.  
 National Toxicology Program  
 R.A. Miller, D.V.M., Ph.D.  
 Experimental Pathology Laboratories, Inc.  
 J.P. Morrison, D.V.M., Ph.D.  
 Pathology Associates International, A Charles River Company  
 A.K.R. Pandiri, B.V.Sc. & A.H., Ph.D.  
 Experimental Pathology Laboratories, Inc.  
 A.B. Rogers, D.V.M., Ph.D.  
 University of North Carolina

**Gene Logic Laboratories, Inc.**

*Provided SMVCE analyses*

B.J.T. Muir, Ph.D., Principal Investigator

B. Atkinson., M.Sc.

H. Batdorf, B.S.

Y. Wang, M.S.

**Biotechnical Services, Inc.**

*Prepared Technical Report*

S.R. Gunnels, M.A., Principal Investigator

L.M. Harper, B.S.

T.S. Kumpe, M.A.

D.C. Serbus, Ph.D.

**SRA International, Inc.**

*Provided statistical analyses*

R.W. Morris, Ph.D., Principal Investigator

L.J. Betz, M.S.

S.F. Harris, B.S.

# CONTENTS

<b>ABSTRACT</b>		7
<b>EXPLANATION OF LEVELS OF EVIDENCE OF CARCINOGENIC ACTIVITY</b>		17
<b>PEER REVIEW PANEL</b>		18
<b>SUMMARY OF PEER REVIEW PANEL COMMENTS</b>		19
<b>INTRODUCTION</b>		21
<b>MATERIALS AND METHODS</b>		35
<b>RESULTS</b>		53
<b>DISCUSSION AND CONCLUSIONS</b>		109
<b>REFERENCES</b>		123
<b>APPENDIX A</b>	<b>Summary of Lesions in Male Rats in the 2-Year Inhalation Study of Vinylidene Chloride</b>	<b>A-1</b>
<b>APPENDIX B</b>	<b>Summary of Lesions in Female Rats in the 2-Year Inhalation Study of Vinylidene Chloride</b>	<b>B-1</b>
<b>APPENDIX C</b>	<b>Summary of Lesions in Male Mice in the 2-Year Inhalation Study of Vinylidene Chloride</b>	<b>C-1</b>
<b>APPENDIX D</b>	<b>Summary of Lesions in Female Mice in the 2-Year Inhalation Study of Vinylidene Chloride</b>	<b>D-1</b>
<b>APPENDIX E</b>	<b>Genetic Toxicology</b>	<b>E-1</b>
<b>APPENDIX F</b>	<b>Clinical Pathology Results</b>	<b>F-1</b>
<b>APPENDIX G</b>	<b>Organ Weights and Organ-Weight-to-Body-Weight Ratios</b>	<b>G-1</b>
<b>APPENDIX H</b>	<b>Reproductive Tissue Evaluations and Estrous Cycle Characterization</b>	<b>H-1</b>
<b>APPENDIX I</b>	<b>Chemical Characterization and Generation of Chamber Concentrations</b>	<b>I-1</b>
<b>APPENDIX J</b>	<b>Ingredients, Nutrient Composition, and Contaminant Levels in NTP-2000 Rat and Mouse Ration</b>	<b>J-1</b>

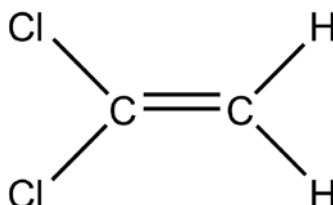
**APPENDIX K**    **Sentinel Animal Program** ..... **K-1**

**APPENDIX L**    **Global Gene Profiling of Mesothelioma**  
**in Vinylidene Chloride-Exposed F344/N Rats** ..... **L-1**





## ABSTRACT



### VINYLDENE CHLORIDE

CAS No. 75-35-4

Chemical Formula:  $C_2H_2Cl_2$       Molecular Weight: 96.94

**Synonyms:** 1,1-dichloroethylene; 1,1-dichloroethene

Vinylidene chloride is used as an intermediate in organic synthesis reactions and is widely used in the production of a variety of polymers. Most of the vinylidene chloride in the plastics industry is used in the production of copolymers with polyvinylidene polymers that have a broad spectrum of application, including in films for household and industrial food packaging, as coatings on a variety of products, in flame-resistant fiber and carpet backing, as binders in paints, and to fabricate filaments, pipes, pipe liners, and gaskets. The highest potential for human exposure to vinylidene chloride is at its point of production and formulation, and occupational exposure may occur via inhalation or dermal contact. The general population is exposed via inhalation and ingestion of contaminated drinking water. Vinylidene chloride was nominated for study by the Agency for Toxic Substances and Disease Registry because of the potential for human exposure, and because there was insufficient critical information concerning its health effects and a need to fill critical data gaps. Male and female F344/N rats and B6C3F1/N mice were exposed to vinylidene chloride (greater than 99.9% pure) by inhalation for 2 weeks, 3 months, or 2 years. Genetic toxicology studies were conducted in *Salmonella typhimurium* and *Escherichia coli*, L5178Y mouse lymphoma cells, *Drosophila melanogaster*, and mouse peripheral blood erythrocytes.

## 2-WEEK STUDY IN RATS

Groups of five male and five female rats were exposed by whole body inhalation to vinylidene chloride vapor at concentrations of 0, 25, 50, 100, 200, or 400 ppm, 6 hours plus  $T_{90}$  (12 minutes) per day, 5 days per week for 16 days. All male and nine of 10 female rats in the 200 and 400 ppm groups were found dead by day 2; one female in the 400 ppm group was found dead on day 4. All other rats survived until the end of the study except one 25 ppm male was removed from the study due to chylothorax (nonexposure-related condition). The mean body weight gain of 100 ppm females was significantly less than that of the chamber controls. All females and nine of 10 males exposed to 200 or 400 ppm became lethargic, while all females and four of five males exposed to 400 ppm developed ataxia. Kidney weights of all surviving groups of exposed males and females were significantly greater than those of the chamber controls. In the liver, centrilobular necrosis was associated with early deaths in male and female rats exposed to 200 or 400 ppm, and centrilobular cytoplasmic alteration of hepatocytes occurred in all exposed male and female rats that survived to terminal kill. The incidences of renal tubule casts in the renal papillae of 200 and 400 ppm rats were significantly increased.

## 2-WEEK STUDY IN MICE

Groups of five male and five female mice were exposed by whole body inhalation to vinylidene chloride vapor at concentrations of 0, 25, 50, 100, 200, or 400 ppm, 6 hours plus  $T_{90}$  (12 minutes) per day, 5 days per week for 17 days. All male mice exposed to 100 ppm or greater died within the first 4 days of exposure. All females exposed to 200 or 400 ppm were found dead following exposure on day 1. One 50 ppm male and one 100 ppm female were removed dead before exposure on day 5. Mean body weights of 25 and 50 ppm male mice were less than those of the chamber control group. Lethargy and abnormal breathing occurred in 50 and 100 ppm males. In all surviving groups of exposed females, lung weights were significantly greater than those of the chamber controls, and the liver weights of 50 and 100 ppm females were significantly greater than those of the chamber controls. Necrosis of the respiratory epithelium of the nose occurred in all mice exposed to 200 or 400 ppm and in all 100 ppm males. In the liver, centrilobular necrosis occurred in all males and females exposed to 100 ppm or greater; in addition, regeneration occurred in the four 100 ppm females that survived to the end of study. In the kidney, proximal renal tubule necrosis and granular casts occurred in all exposed males.

### 3-MONTH STUDY IN RATS

Groups of 10 male and 10 female rats were exposed by whole body inhalation to vinylidene chloride vapor at concentrations of 0, 6.25, 12.5, 25, 50, or 100 ppm, 6 hours plus T<sub>90</sub> (10 minutes) per day, 5 days per week for 14 weeks. Additional clinical pathology groups of 10 male and 10 female rats were exposed to the same concentrations for 23 days. All rats survived until the end of the study. Mean body weights of exposed groups were similar to those of the chamber control groups. Sorbitol dehydrogenase activities were increased in 100 ppm females on day 3 and 100 ppm males and 50 and 100 ppm females on day 23. Alanine aminotransferase activities were increased on day 3 in 50 and 100 ppm male rats and on day 23 in 100 ppm male rats. Kidney weights of 12.5 ppm or greater females were significantly greater than those of the chamber controls. In males, sperm motility was decreased and spermatid/g testis and total spermatid/testis were lower at 100 ppm than those of the chamber control groups. No treatment-related effects were observed in females. These data suggest that vinylidene chloride may be a reproductive toxicant in male, but not female rats.

A combination of lesions in the nasal epithelium of male and female rats including olfactory epithelium atrophy, mineralization, and necrosis and turbinate atrophy occurred with generally increasing severity with increasing exposure concentration. In the liver, the incidences of centrilobular cytoplasmic alteration were significantly increased in males exposed to 12.5 ppm or greater, and cytoplasmic vacuolization occurred in all 50 and 100 ppm females.

### 3-MONTH STUDY IN MICE

Groups of 10 male and 10 female mice were exposed by whole body inhalation to vinylidene chloride vapor at concentrations of 0, 6.25, 12.5, 25, 50, or 100 ppm (females only), 6 hours plus T<sub>90</sub> (10 minutes) per day, 5 days per week for 14 weeks. Two 50 ppm males and four 100 ppm females died during the first week of the study. The mean body weights of all exposed groups of females and of males exposed to 12.5 ppm or greater were significantly less than those of the chamber control groups. Exposure concentration-related decreases in the erythrocyte counts, hemoglobin concentrations, and hematocrit values occurred at the end of the study in 12.5, 25, and 50 ppm male mice. Female mice had decreased erythrocyte counts in the 50 and 100 ppm groups. In addition, hemoglobin

concentration and the hematocrit value were decreased in 50 ppm female mice. Absolute kidney weights of all exposed groups of males were significantly less than that of the chamber control group. Absolute and relative liver weights of 12.5 ppm or greater females and absolute and relative kidney and lung weights of 100 ppm females were significantly greater than those of the chamber controls. In males, decreased cauda epididymis weights at 25 and 50 ppm and total sperm/cauda epididymis in all vinylidene chloride-exposed groups were observed. No treatment-related effects were observed in females. These data suggest that vinylidene chloride may be a reproductive toxicant in male, but not female mice.

In male mice, the incidences and severities of nephropathy were significantly increased in the 12.5, 25, and 50 ppm groups, and two 50 ppm males had renal tubule necrosis and protein casts. The incidence of respiratory epithelium squamous metaplasia of the larynx was significantly increased in the 50 ppm males. In female mice, laryngeal lesions consisted of necrosis and respiratory epithelium hyperplasia and squamous metaplasia and occurred primarily in the 100 ppm group. Exposure-related lung lesions were limited to 100 ppm female mice and consisted of bronchial epithelium necrosis and histiocytic inflammation. The incidences of nasal necrosis of the respiratory epithelium and atrophy of the turbinate were significantly increased in 100 ppm females. The incidences of necrosis and hypertrophy of the liver were significantly increased in 100 ppm females, and necrosis occurred in two 50 ppm males.

## **2-YEAR STUDY IN RATS**

Groups of 50 male and 50 female rats were exposed by whole body inhalation to vinylidene chloride vapor at concentrations of 0, 25, 50, or 100 ppm, 6 hours plus T<sub>90</sub> (10 minutes) per day, 5 days per week for 105 weeks. Survival of exposed groups of males was similar to that of the chamber control group. Survival of 100 ppm females was significantly less than that of the chamber controls. Mean body weights of exposed groups of male and female rats were similar to those of the chamber control groups throughout the study.

In male rats, the incidences of malignant mesothelioma occurred with a positive trend and were significantly increased in all exposed groups compared to the chamber control group. Malignant mesothelioma occurred in one 25 ppm female and one 50 ppm female. Global gene expression analysis was performed to identify overrepresented

pathways involved in mesotheliomas from vinylidene chloride-exposed F344/N rats compared to spontaneous mesotheliomas in control F344/N rats.

The incidence of C-cell adenoma of the thyroid gland was significantly increased in 100 ppm females, and the incidence of C-cell carcinoma was significantly increased in 25 ppm females. The incidences of adenoma or carcinoma (combined) were significantly increased in 25 and 100 ppm females.

The incidence of mononuclear cell leukemia was significantly increased in 100 ppm females.

Renal tubule carcinomas were observed in several vinylidene chloride exposed males; these neoplasms are rare in male F344/N rats.

The only exposure-related primary nasal neoplasm observed in rats was adenoma in the respiratory epithelium. Exposure concentration-related increased incidences of turbinate atrophy and hypertosis, olfactory epithelium respiratory metaplasia, respiratory epithelium hyperplasia, and chronic active inflammation occurred in all exposed groups of male and female rats, and the severities of the lesions generally increased with increasing exposure concentration.

The incidences of alveolar epithelium hyperplasia in the lung were significantly increased in all exposed groups of male rats; the severities increased with increasing exposure concentration.

In the liver of rats, increased incidences of chronic inflammation, diffuse fatty change, and cystic degeneration in males and females and necrosis in females occurred.

## **2-YEAR STUDY IN MICE**

Groups of 50 male and 50 female mice were exposed by whole body inhalation to vinylidene chloride vapor at concentrations of 0, 6.25, 12.5, or 25 ppm, 6 hours plus T<sub>90</sub> (10 minutes) per day, 5 days per week for 105 weeks. Survival of 6.25 ppm males was significantly greater than that of the chamber controls. Survival of 25 ppm males

and 6.25 and 25 ppm females was significantly less than that of the chamber control groups. Mean body weights of 12.5 and 25 ppm males were at least 10% less than those of the chamber control group after weeks 17 and 13, respectively, and those of 25 ppm females were at least 10% less after week 21. Exposure-related clinical findings included thinness and abnormal breathing in 25 ppm males and abnormal breathing, thinness, and ventral torso mass in all exposed groups of females.

The incidences of renal tubule adenoma, renal tubule carcinoma, and renal tubule adenoma or carcinoma (combined) were significantly increased in all exposed groups of males; the incidences of renal tubule hyperplasia were also significantly increased in all exposed groups of males.

The incidences of hemangioma (all organs) in all exposed groups of females were increased compared to that in the chamber controls, and the incidence of hemangioma or hemangiosarcoma (combined) in 25 ppm females was significantly greater than that in the chamber controls.

The incidences of hepatocellular adenoma in 12.5 ppm females, hepatocellular carcinoma in 25 ppm females, and hepatocellular adenoma or carcinoma (combined) in 12.5 and 25 ppm females were significantly greater than those in the chamber control group. In addition, hepatocholangiocarcinoma occurred in all exposed groups of females. The incidences of hepatocholangiocarcinoma in exposed groups of males were increased compared to that in the concurrent chamber control group and exceeded the historical control range for inhalation studies. In females, this neoplasm is much less common than in males; it has not been observed in 300 inhalation controls or 948 controls from all routes of exposure. In males, hepatocholangiocarcinoma has been reported in two animals from 299 inhalation studies and in 10 male mice from all routes of exposure.

The incidence of alveolar/bronchiolar carcinoma was significantly increased in 12.5 ppm females.

In 25 ppm females, the incidence of carcinoma of the small intestine exceeded the historical control ranges for inhalation studies and all routes of administration.

Turbinates atrophy, hyperostosis, and olfactory epithelium respiratory metaplasia occurred in the nose of the vast majority of exposed male and female mice, and the severity of these lesions increased with increasing exposure concentration. The incidences of olfactory epithelium hyaline droplet accumulation in 12.5 and 25 ppm males and 25 ppm females and respiratory epithelium hyperplasia in 25 ppm females were significantly increased compared to controls.

## GENETIC TOXICOLOGY

Vinylidene chloride was not mutagenic in any of several strains of *Salmonella typhimurium* when testing occurred with or without exogenous metabolic activation using a preincubation protocol. However, when tested in a closed system as a vapor, vinylidene chloride was mutagenic in mouse lymphoma L5178Y *tk*<sup>+/-</sup> cells in the presence of exogenous metabolic activation provided by induced male rat liver S9 mix and questionable without S9. *In vivo*, no increase in sex-linked recessive lethal mutations was seen in germ cells of adult male *Drosophila melanogaster* exposed via feeding or injection to vinylidene chloride. No increase in the frequency of micronucleated erythrocytes was observed in peripheral blood of male or female B6C3F1/N mice exposed to vinylidene chloride by inhalation for a period of 3 months.

## CONCLUSIONS

Under the conditions of this 2-year inhalation study, there was *clear evidence of carcinogenic activity*\* of vinylidene chloride in male F344/N rats based on increased incidences of malignant mesothelioma. Increased incidences of renal tubule carcinoma and respiratory epithelium adenoma in the nose of male rats were also considered to be related to vinylidene chloride exposure. There was *some evidence of carcinogenic activity* of vinylidene chloride in female F344/N rats based on increased incidences of C-cell adenoma or carcinoma in the thyroid gland and systemic mononuclear cell leukemia. Occurrences of malignant mesothelioma may have been related to vinylidene chloride exposure. There was *clear evidence of carcinogenic activity* of vinylidene chloride in male B6C3F1/N mice based on increased incidences of renal tubule adenoma and carcinoma. Increased incidences of hepatocholangiocarcinoma may have been related to vinylidene chloride exposure. There was *clear evidence of carcinogenic activity* of vinylidene chloride in female B6C3F1/N mice based on increased incidences systemic hemangioma or

hemangiosarcoma (combined). Hepatocholangiocarcinoma and hepatocellular adenoma and carcinoma (combined) in the liver of female mice were also considered to be related to vinylidene chloride exposure. Increased incidences of alveolar/bronchiolar carcinoma in the lungs and carcinoma of the small intestine may have been related to treatment.

Exposure to vinylidene chloride caused increases in the incidences of nonneoplastic lesions in the nose of rats and mice, the liver of rats, the lung of male rats, and the kidney of male mice.

---

\* Explanation of Levels of Evidence of Carcinogenic Activity is on page 17.



---

**Summary of the 2-Year Carcinogenesis and Genetic Toxicology Studies of Vinylidene Chloride**


---

	Male F344/N Rats	Female F344/N Rats	Male B6C3F1/N Mice	Female B6C3F1/N Mice
<b>Concentrations in air</b>	0, 25, 50, or 100 ppm	0, 25, 50, or 100 ppm	0, 6.25, 12.5, or 25 ppm	0, 6.25, 12.5, or 25 ppm
<b>Body weights</b>	Exposed groups similar to the chamber control group	Exposed groups similar to the chamber control group	12.5 and 25 ppm groups 10% less than the chamber control group after weeks 17 and 13, respectively	25 ppm group 10% less than the chamber control group after week 21
<b>Survival rates</b>	25/50, 27/50, 22/50, 19/50	30/50, 26/50, 30/50, 19/50	29/50, 40/50, 32/50, 19/50	36/50, 25/50, 30/50, 24/50
<b>Nonneoplastic effects</b>	<p><u>Nose</u>: turbinate, atrophy (0/49, 50/50, 50/50, 50/50); turbinate, hyperostosis (0/49, 49/50, 50/50, 50/50); olfactory epithelium, metaplasia, respiratory (3/49, 49/50, 49/50, 48/50); respiratory epithelium, hyperplasia (5/49, 8/50, 22/50, 31/50); inflammation, chronic active (9/49, 36/50, 45/50, 48/50)</p> <p><u>Lung</u>: alveolar epithelium hyperplasia (7/50, 18/50, 14/50, 14/50)</p> <p><u>Liver</u>: chronic inflammation (28/50, 46/50, 46/50, 44/50); diffuse fatty change (4/50, 19/50, 18/50, 26/50); cystic degeneration (2/50, 5/50, 7/50, 12/50)</p>	<p><u>Nose</u>: turbinate, atrophy (0/50, 50/50, 50/50, 50/50); turbinate, hyperostosis (0/50, 50/50, 50/50, 50/50); olfactory epithelium, metaplasia, respiratory (1/50, 50/50, 50/50, 50/50); respiratory epithelium, hyperplasia (4/50, 12/50, 14/50, 27/50); inflammation, chronic active (7/50, 45/50, 46/50, 46/50)</p> <p><u>Liver</u>: chronic inflammation (42/50, 48/50, 49/50, 48/50); diffuse fatty change (19/50, 30/50, 26/50, 30/50); cystic degeneration (0/50, 2/50, 4/50, 7/50); necrosis (0/50, 3/50, 5/50, 11/50)</p>	<p><u>Kidney</u>: renal tubule hyperplasia (0/50, 8/50, 22/50, 16/50)</p> <p><u>Nose</u>: turbinate, atrophy (0/50, 46/50, 46/49, 47/49); hyperostosis (1/50, 27/50, 45/49, 48/49); olfactory epithelium, metaplasia, respiratory (17/50, 39/50, 47/49, 48/49); olfactory epithelium, accumulation, hyaline droplet (2/50, 5/50, 13/49, 11/49);</p>	<p><u>Nose</u>: turbinate, atrophy (0/50, 46/50, 50/50, 49/50); hyperostosis (0/50, 13/50, 45/50, 48/50); olfactory epithelium, metaplasia, respiratory (3/50, 29/50, 49/50, 50/50); olfactory epithelium, accumulation, hyaline droplet (18/50, 18/50, 13/50, 32/50); respiratory epithelium, hyperplasia (33/50, 41/50, 39/50, 43/50)</p>
<b>Neoplastic effects</b>	<p><u>All organs</u>: malignant mesothelioma (1/50, 12/50, 28/50, 23/50)</p> <p><u>Kidney</u>: renal tubule carcinoma (0/50, 2/50, 1/49, 1/50)</p> <p><u>Nose</u>: respiratory epithelium, adenoma (0/49, 0/50, 1/50, 4/50)</p>	<p><u>Thyroid gland (C-cell)</u>: adenoma (3/50, 4/50, 6/48, 11/50); carcinoma (0/50, 6/50, 2/48, 2/50); adenoma or carcinoma (3/50, 10/50, 8/48, 13/50)</p> <p><u>All organs</u>: mononuclear cell leukemia (10/50, 11/50, 13/50, 25/50)</p>	<p><u>Kidney</u>: renal tubule adenoma (0/50, 5/50, 19/50, 10/50); renal tubule carcinoma (0/50, 7/50, 31/50, 18/50); renal tubule adenoma or carcinoma (0/50, 11/50, 37/50, 27/50)</p>	<p><u>All Organs</u>: hemangioma or hemangiosarcoma (4/50, 6/50, 6/50, 11/50)</p> <p><u>Liver</u>: hepatocellular adenoma (25/50, 21/50, 36/50, 29/50); hepatocellular carcinoma (8/50, 14/50, 12/50, 17/50); hepatocellular adenoma or carcinoma (28/50, 30/50, 37/50, 38/50); hepatocholangiocarcinoma (0/50, 1/50, 1/50, 2/50)</p>

---

---

**Summary of the 2-Year Carcinogenesis and Genetic Toxicology Studies of Vinylidene Chloride**


---

	Male F344/N Rats	Female F344/N Rats	Male B6C3F1/N Mice	Female B6C3F1/N Mice
<b>Equivocal findings</b>	None	<u>All organs</u> : malignant mesothelioma (0/50, 1/50, 1/50, 0/50)	<u>Liver</u> : hepatocholangiocarcinoma (1/50, 2/50, 2/50, 3/50)	<u>Lung</u> : alveolar/bronchiolar carcinoma (1/50, 2/50, 7/50, 5/49) <u>Small Intestine (Duodenum, Jejunum, or Ileum)</u> : carcinoma (1/50, 1/50, 1/50, 3/50)
<b>Level of evidence of carcinogenic activity</b>	Clear evidence	Some evidence	Clear evidence	Clear evidence
<b>Genetic toxicology</b>				
Bacterial gene mutations:			Negative in <i>Salmonella typhimurium</i> strains TA98, TA100, TA1535, and TA1537	
Mouse lymphoma gene mutations:			Positive in mouse lymphoma L5178Y <i>tk</i> <sup>+/+</sup> cells with S9, questionable in the absence of S9	
Sex-linked recessive lethal mutations <i>Drosophila melanogaster</i> :			No induction of sex-linked recessive lethal mutations	
Micronucleated erythrocytes Mouse peripheral blood <i>in vivo</i> :			Negative in males and females	

---

## EXPLANATION OF LEVELS OF EVIDENCE OF CARCINOGENIC ACTIVITY

The National Toxicology Program describes the results of individual experiments on a chemical agent and notes the strength of the evidence for conclusions regarding each study. Negative results, in which the study animals do not have a greater incidence of neoplasia than control animals, do not necessarily mean that a chemical is not a carcinogen, inasmuch as the experiments are conducted under a limited set of conditions. Positive results demonstrate that a chemical is carcinogenic for laboratory animals under the conditions of the study and indicate that exposure to the chemical has the potential for hazard to humans. Other organizations, such as the International Agency for Research on Cancer, assign a strength of evidence for conclusions based on an examination of all available evidence, including animal studies such as those conducted by the NTP, epidemiologic studies, and estimates of exposure. Thus, the actual determination of risk to humans from chemicals found to be carcinogenic in laboratory animals requires a wider analysis that extends beyond the purview of these studies.

Five categories of evidence of carcinogenic activity are used in the Technical Report series to summarize the strength of evidence observed in each experiment: two categories for positive results (**clear evidence and some evidence**); one category for uncertain findings (**equivocal evidence**); one category for no observable effects (**no evidence**); and one category for experiments that cannot be evaluated because of major flaws (**inadequate study**). These categories of interpretative conclusions were first adopted in June 1983 and then revised on March 1986 for use in the Technical Report series to incorporate more specifically the concept of actual weight of evidence of carcinogenic activity. For each separate experiment (male rats, female rats, male mice, female mice), one of the following five categories is selected to describe the findings. These categories refer to the strength of the experimental evidence and not to potency or mechanism.

- **Clear evidence** of carcinogenic activity is demonstrated by studies that are interpreted as showing a dose-related (i) increase of malignant neoplasms, (ii) increase of a combination of malignant and benign neoplasms, or (iii) marked increase of benign neoplasms if there is an indication from this or other studies of the ability of such tumors to progress to malignancy.
- **Some evidence** of carcinogenic activity is demonstrated by studies that are interpreted as showing a chemical-related increased incidence of neoplasms (malignant, benign, or combined) in which the strength of the response is less than that required for clear evidence.
- **Equivocal evidence** of carcinogenic activity is demonstrated by studies that are interpreted as showing a marginal increase of neoplasms that may be chemical related.
- **No evidence** of carcinogenic activity is demonstrated by studies that are interpreted as showing no chemical-related increases in malignant or benign neoplasms
- **Inadequate study** of carcinogenic activity is demonstrated by studies that, because of major qualitative or quantitative limitations, cannot be interpreted as valid for showing either the presence or absence of carcinogenic activity.

For studies showing multiple chemical-related neoplastic effects that if considered individually would be assigned to different levels of evidence categories, the following convention has been adopted to convey completely the study results. In a study with clear evidence of carcinogenic activity at some tissue sites, other responses that alone might be deemed some evidence are indicated as “were also related” to chemical exposure. In studies with clear or some evidence of carcinogenic activity, other responses that alone might be termed equivocal evidence are indicated as “may have been” related to chemical exposure.

When a conclusion statement for a particular experiment is selected, consideration must be given to key factors that would extend the actual boundary of an individual category of evidence. Such consideration should allow for incorporation of scientific experience and current understanding of long-term carcinogenesis studies in laboratory animals, especially for those evaluations that may be on the borderline between two adjacent levels. These considerations should include:

- adequacy of the experimental design and conduct;
- occurrence of common versus uncommon neoplasia;
- progression (or lack thereof) from benign to malignant neoplasia as well as from preneoplastic to neoplastic lesions;
- some benign neoplasms have the capacity to regress but others (of the same morphologic type) progress. At present, it is impossible to identify the difference. Therefore, where progression is known to be a possibility, the most prudent course is to assume that benign neoplasms of those types have the potential to become malignant;
- combining benign and malignant tumor incidence known or thought to represent stages of progression in the same organ or tissue;
- latency in tumor induction;
- multiplicity in site-specific neoplasia;
- metastases;
- supporting information from proliferative lesions (hyperplasia) in the same site of neoplasia or other experiments (same lesion in another sex or species);
- presence or absence of dose relationships;
- statistical significance of the observed tumor increase;
- concurrent control tumor incidence as well as the historical control rate and variability for a specific neoplasm;
- survival-adjusted analyses and false positive or false negative concerns;
- structure-activity correlations; and
- in some cases, genetic toxicology.

**NATIONAL TOXICOLOGY PROGRAM TECHNICAL REPORTS  
PEER REVIEW PANEL**

The members of the Peer Review Panel who evaluated the draft NTP Technical Report on vinylidene chloride on October 29, 2013, are listed below. Panel members serve as independent scientists, not as representatives of any institution, company, or governmental agency. In this capacity, panel members have five major responsibilities in reviewing the NTP studies:

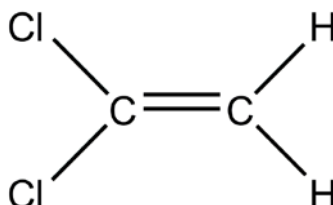
- to ascertain that all relevant literature data have been adequately cited and interpreted,
- to determine if the design and conditions of the NTP studies were appropriate,
- to ensure that the Technical Report presents the experimental results and conclusions fully and clearly,
- to judge the significance of the experimental results by scientific criteria, and
- to assess the evaluation of the evidence of carcinogenic activity and other observed toxic responses.

## **SUMMARY OF PEER REVIEW PANEL COMMENTS**

**NOTE:** A summary of the Peer Review Panel's remarks will appear in a future draft of this report.



## INTRODUCTION



### VINYLDENE CHLORIDE

CAS No. 75-35-4

Chemical Formula:  $C_2H_2Cl_2$       Molecular Weight: 96.94

**Synonyms:** 1,1-dichloroethylene; 1,1-dichloroethene

### CHEMICAL AND PHYSICAL PROPERTIES

Vinylidene chloride is a clear, volatile liquid that has a sweet odor and a melting point of  $-122.1^\circ\text{C}$ , a boiling point of  $31.7^\circ\text{C}$ , and a vapor pressure of 400 mm at  $14.8^\circ\text{C}$  (Gibbs and Wessling, 1983; IARC, 1986, 1999; Torkelson, 1994; *Merck*, 2006). Vinylidene chloride is insoluble in water, but miscible with most organic solvents (*Merck*, 2006). In the absence of an added inhibitor, monomethyl ether of hydroquinone, vinylidene chloride readily polymerizes. In the presence of air or oxygen, shock-sensitive and explosive peroxides are formed.

### PRODUCTION, USE, AND HUMAN EXPOSURE

Vinylidene chloride is a man-made chemical that is not known to occur naturally. It is produced commercially via the dehydrochlorination of 1,1,2-trichloroethane with an aqueous alkali, like sodium hydroxide or lime (Gibbs and Wessling, 1983). Vinylidene chloride can be purified through distillation and extraction. Commercial grade vinylidene chloride contains up to 200 ppm MEHQ that is added to prevent polymerization and the formation of explosive peroxides. In order to manufacture vinylidene chloride polymers, polymerization initiators are added.

The annual production of vinylidene chloride in the United States has varied between 68,000 and 90,000 tons (Gibbs and Wessling, 1983; IARC, 1986, 1999; Cotti *et al.*, 1988; HSDB, 2003) with the most recent estimate of 79,000 tons (HSDB, 2003). In 1990, the world-wide production was estimated at 290,000 tons (IPCS, 1990; HSDB, 2003).

Vinylidene chloride is used as an intermediate in organic synthesis reactions and is widely used in the production of a variety of polymers. For increased polymer stability, it is usually copolymerized with other chemicals, such as vinyl chloride, acrylonitrile, methacrylonitrile, and methacrylate (Gibbs and Wessling, 1983). Most of the vinylidene chloride in the plastics industry is used in the production of copolymers with polyvinylidene polymers that have a broad spectrum of application in film form and as solvent-soluble resins, water dispersions, and latexes (Gibbs and Wessling, 1983; IARC, 1986, 1999; ATSDR, 1994; USEPA, 2002). These polymers are used extensively in films for household and industrial food packaging based on their oxygen-barrier properties. Solvent-soluble resins are used as coatings on other polymer films; paper cups and plates; pipes; ship, railroad, and fuel storage tanks; and binders in coatings for various tapes (Maltoni *et al.*, 1985). Latexes and extruded fibers made from vinylidene chloride copolymers are used in coating plastics, in flame-resistant fiber and carpet backing, as binders in paints, and to fabricate filaments, pipes, pipe liners, and gaskets (Maltoni *et al.*, 1985).

The highest potential for human exposure to vinylidene chloride is at its point of production and formulation. Occupational exposure may occur via inhalation or dermal contact (ATSDR, 1994; IARC, 1999; HSDB, 2003). The U.S. Environmental Protection Agency reported that 6,500 workers in monomer and polymer plants were exposed to air levels of 25 to 100  $\mu\text{g}/\text{m}^3$  (IARC, 1986). The primary source of vinylidene chloride in the environment is through volatile air emissions in the atmosphere and in effluent waters from plants synthesizing vinylidene chloride and its copolymers, or manufacturing products containing vinylidene chloride. The general population is exposed via inhalation and ingestion of contaminated drinking water. Based on personal air sampling in the general population, Wallace (1991) estimated mean vinylidene chloride exposure to be 6.5  $\mu\text{g}/\text{m}^3$ . Consumers may also be exposed via migration of vinylidene chloride from the films and coatings of packaging materials into foods contained in the packaging. The recommended threshold limit value for occupational exposure to vinylidene



chloride is currently 5 ppm for 8 hours based on effects involving the liver and kidney (HSDB, 2003; ACGIH, 2013).

## **ABSORPTION, DISTRIBUTION, METABOLISM, AND EXCRETION**

### **Experimental Animals**

Following inhalation exposure in rats, the absorption of vinylidene chloride was rapid and concentration-dependent. The uptake was linear for concentrations up to 150 ppm above which the uptake decreased with the increasing concentration (McKenna *et al.*, 1978a; Dallas *et al.*, 1983). The compound was found in blood of rats within 2 minutes following exposure. Following exposure to concentrations up to 2,000 ppm [<sup>14</sup>C]vinylidene chloride, the highest level of total radioactivity was found in the liver and kidney, with only very small amounts present in other tissues (Jaeger, 1977; McKenna *et al.*, 1977, 1978a). Covalently bound radioactivity was also highest in the liver and the kidney with fasted rats having higher levels than nonfasted (McKenna *et al.*, 1977, 1978a). Following exposure to 10 ppm for 6 hours, a higher body burden was observed in mice than in rats exposed under similar conditions. The bound radioactivity was higher in mouse liver and kidney than in corresponding tissues in rats (McKenna *et al.*, 1977). Elimination of vinylidene chloride following inhalation exposure in rats was rapid with the majority of the dose eliminated in the urine. Steady state levels in expired air were achieved following exposure to 25 to 150 ppm vinylidene chloride, indicating that the elimination is first order at these levels; about 1% of the dose was excreted unchanged in the expired air at these exposure concentrations. At concentrations greater than 150 ppm, levels in expired air increased indicating saturation of metabolism (Dallas *et al.*, 1983). The pulmonary elimination was biphasic in rats following inhalation exposure; the half-lives for the first and second phases, respectively, based on the unchanged compound were 20 and 217 minutes following exposure to 10 ppm and 21 and 133 minutes following exposure to 200 ppm [<sup>14</sup>C]vinylidene chloride. Urinary elimination followed a similar pattern; the half-lives for the first and second phases, respectively, based on the total [<sup>14</sup>C] excretion in urine were 3.1 and 19.3 hours following exposure to 10 ppm and 3.8 and 23.9 hours following exposure to 200 ppm [<sup>14</sup>C]vinylidene chloride. The major portion of the dose was eliminated in both the breath and the urine during the rapid first phase. Fasting did not affect the elimination kinetics of vinylidene chloride in rats (McKenna *et al.*, 1977, 1978a). Limited data in mice following inhalation exposure to 10 ppm vinylidene chloride indicated that the

elimination of unchanged compound in the expired air is smaller and elimination via urine is larger compared to rats, indicating that mice metabolize vinylidene chloride at a greater rate than rats (McKenna *et al.*, 1977).

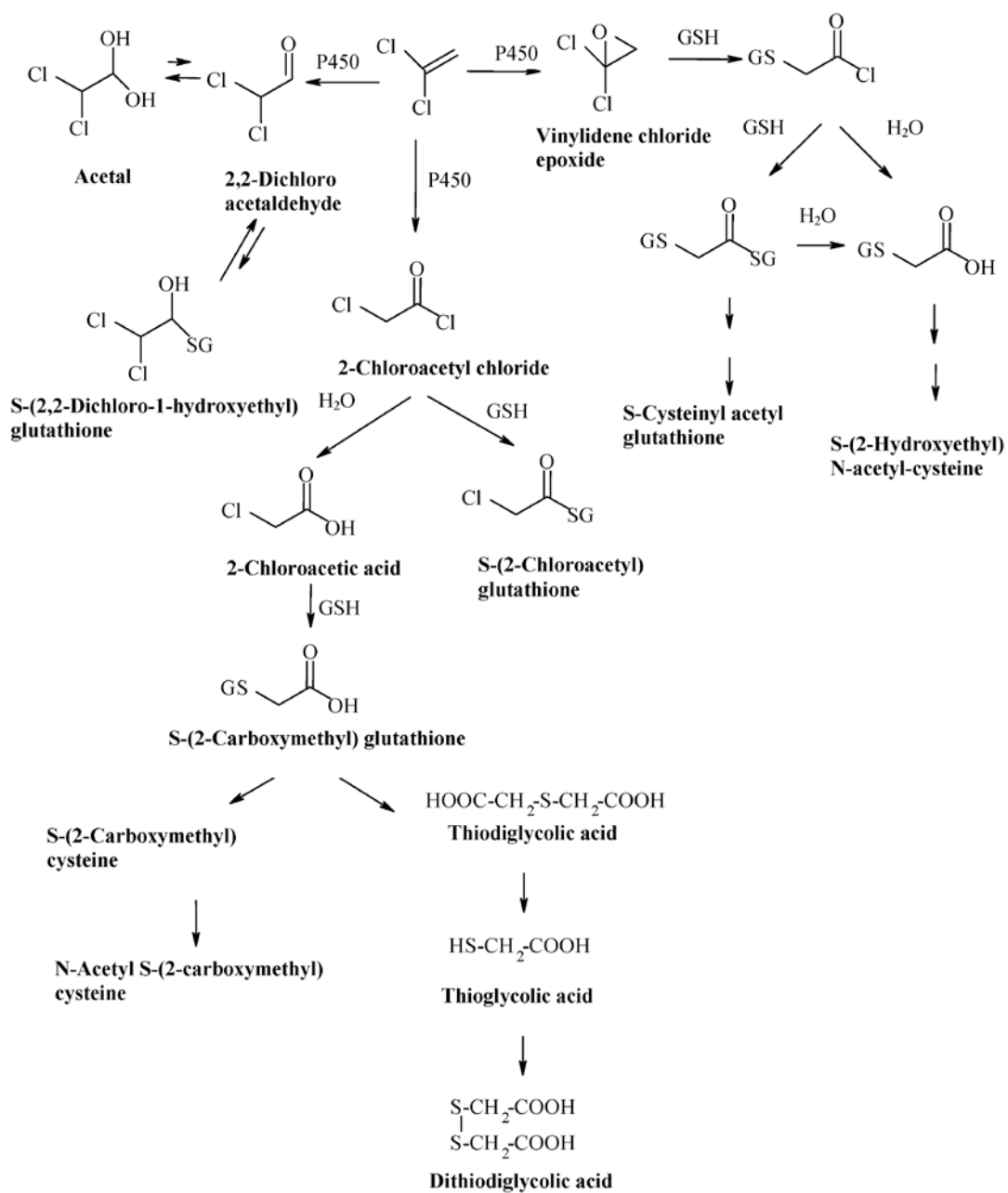
An investigation of the plasma toxicokinetics of vinylidene chloride in Sprague-Dawley rats showed that the  $C_{\max}$  and  $AUC_{0-\infty}$ , respectively, following inhalation exposure to 300 ppm were 2.8 mg/L and 279  $\mu\text{g}\cdot\text{min}/\text{mL}$ ; the elimination half-life and bioavailability, respectively, were 50 minutes and 55.7% (Bruckner *et al.*, 2010).

Following oral administration of doses ranging from 0.5 to 100 mg/kg, vinylidene chloride was rapidly and almost completely absorbed in rats and mice and distributed to all tissues examined (Jones and Hathway 1978a; McKenna, 1978b; Reichert *et al.*, 1979; Chieco *et al.*, 1981; Pucha *et al.*, 1986; Torkelson, 1994). Peak blood levels were observed in rats within 2 to 8 minutes (Pucha *et al.*, 1986). Vinylidene chloride was distributed to all tissues following administration with the highest amount found in the liver and kidney (Jones and Hathway, 1978b; McKenna *et al.*, 1978b). The pattern of elimination was similar to that following inhalation exposure. Following a single administration of 1 mg/kg in rats, about 1% to 3% of the dose was excreted in expired air as unchanged chemical, with 21% recovered as carbon dioxide (McKenna, 1978b). The majority of the dose was eliminated in urine (63%) and some in feces (16%) within 72 hours, with the majority excreted within the first 24 hours. Following administration of 50 mg/kg, 16% to 30% of the dose was excreted in expired air as the parent with concomitant reductions in the expired carbon dioxide (3% to 6%) and urinary excretion (35% to 47%) suggesting that metabolism saturates at rather low doses (Jones and Hathway, 1978b; McKenna *et al.*, 1978b; Reichert *et al.*, 1979). Fasting slightly modified the elimination of vinylidene chloride in rats after oral administration; 29% of a 50 mg/kg dose was excreted unchanged in expired air compared to 19% in fed rats (McKenna *et al.*, 1978b). Mice eliminated less in expired air as unchanged chemical and more in urine than rats following oral administration of 50 mg/kg (Jones and Hathway, 1978a). The elimination of vinylidene chloride following oral administration in rats was biphasic (McKenna *et al.*, 1978b, Reichert *et al.*, 1979). Half-lives for the two phases, respectively, for pulmonary elimination were 25 and 117 minutes for a 1 mg/kg dose and 21 and 66 minutes for 50 mg/kg (McKenna *et al.*, 1978b). For urinary elimination of total radioactivity, the estimated half-lives for the first and the second phases were 6 and 17 hours for both doses. Plasma toxicokinetics of vinylidene chloride in Sprague-Dawley rats following gavage exposure showed a similar behavior to inhalation exposure (Bruckner *et al.*, 2010). The  $C_{\max}$  and

AUC<sub>0-∞</sub>, respectively, following gavage exposure to 30 mg/kg were 8.9 mg/L and 233 µg·min/mL; the elimination half-life and bioavailability, respectively, were 88 minutes and 46.5%.

In a study where mice were administered a single intraperitoneal injection of 125 mg/kg [<sup>14</sup>C] vinylidene chloride, radioactivity was distributed to all examined tissues with the highest levels of radioactivity found in the kidney, liver, and lung 6 hours after administration (Okine *et al.*, 1985).

The metabolism of vinylidene chloride is saturable, and unmetabolized vinylidene chloride is primarily eliminated via exhalation from the lung regardless of the method of administration (McKenna *et al.*, 1977; Andersen *et al.*, 1979; Dallas *et al.*, 1983). The proposed pathway for the metabolism of vinylidene chloride in rodents is shown in Figure 1. Vinylidene chloride is metabolized in rodents via pathways involving CYP2E1 to yield three reactive metabolites: vinylidene chloride epoxide, 2-chloroacetyl chloride, and 2,2-dichloroacetaldehyde. These electrophilic metabolites undergo oxidation, hydrolysis, and reactions with glutathione and cellular macromolecules. The oxidative metabolism of vinylidene chloride has been reported to saturate in rats at around 200 ppm following inhalation and between 10 to 50 mg/kg following oral exposure (McKenna *et al.*, 1977; Andersen *et al.*, 1979; Dallas *et al.*, 1983; D'Souza and Andersen, 1988). The involvement of glutathione in the detoxification of vinylidene chloride was consistent with the observation that exposure to vinylidene chloride depletes liver glutathione levels (Jaeger *et al.*, 1974; Reichert *et al.*, 1978; Reynolds *et al.*, 1980). Urinary metabolites identified were *N*-acetyl-*S*-(2-hydroxyethyl)cysteine, *S*-(cysteinyl acetyl) glutathione, *N*-acetyl-*S*-(2-carboxymethyl)cysteine, thiodiglycolic acid, dithioglycolic acid, dithiodiglycolic acid, chloroacetic acid, and biliary metabolites identified were *S*-(2-carboxymethyl)glutathione, *S*-(cysteinyl acetyl)glutathione, and a product of the intramolecular rearrangement of the metabolite, *S*-(2-chloroacetyl)glutathione (Jones and Hathway, 1978a,b; Costa and Ivanetich, 1982; Okine *et al.*, 1985; Liebler *et al.*, 1985, 1988; Okine and Gram, 1986; Torkelson, 1994; Dowsley *et al.*, 1995; Forkert, 1999a,b; Jones *et al.*, 2003; Simmonds, 2004). In addition, several carboxymethylated proteins were identified in bile from vinylidene chloride treated rats (Jones *et al.*, 2003). Mice metabolized a greater portion of the orally administered vinylidene chloride than rats (Jones and Hathway, 1978b; Dowsley *et al.*, 1995). Although the types of metabolites observed in rats and mice were similar, *N*-acetyl-*S*-(2-carboxymethyl)cysteine arising likely from the 2-chloroacetyl chloride pathway was detected in mice but not in rats. In addition, quantitatively, mice produced



**FIGURE 1**  
The Proposed Metabolic Pathway of Vinylidene Chloride in Rodents

more *S*-(2-hydroxyethyl)-*N*-acetyl cysteine [previously identified by Jones and Hathway (1978b) as *N*-acetyl-*S*-cysteinyl acetyl derivative], a product of the reaction between vinylidene chloride epoxide with glutathione, than rats suggesting that the formation of vinylidene chloride epoxide is higher in mice than in rats.

In addition, several investigations in rat liver microsome incubations and mouse liver and lung microsomal incubations have shown that vinylidene chloride epoxide is the major and likely the most important cytotoxic metabolite; minor metabolites identified were 2,2,-dichloroacetaldehyde and 2-chloroacetylchloride (Costa and Ivaneitch, 1982; Leibeler and Guengerich, 1983; Liebler *et al.*, 1985; Dowsley *et al.*, 1995, 1996; Forkert, 2001; Simmonds *et al.*, 2004). As seen *in vivo*, these metabolites undergo secondary reactions including oxidation, glutathione conjugation and hydrolysis. The levels of the acetal observed in lung microsomes were higher than those in the liver microsomal incubations (Dowsley *et al.*, 1996). It was also demonstrated that the mean rate of formation of the epoxide was twofold higher in mouse lung microsomal incubations compared to human lung microsomal incubations (Dowsley *et al.*, 1996). Simmonds *et al.* (2004) showed that both CYP2E1 and CYP2F2 catalyze the bioactivation of vinylidene chloride to its epoxide in the mouse lung microsomes. Using incubations of mouse lung microsomes, and recombinant CYP2E1 (rat and human), CYP2F2 (mouse), CYP2F3 (goat), and CYP2F4 (rat), they further demonstrated that vinylidene chloride metabolism occurred with different affinities and catalytic efficiencies in different species, suggesting species differences in the severities of toxicities by vinylidene chloride. Recombinant rat CYP2E1 showed greater affinity and efficiency for vinylidene chloride than human CYP2E1, mouse CYP2F2, goat CYP2F3, or rat CYP2F4.

There are several critical factors that contribute to the metabolism of vinylidene chloride. Glutathione levels and glutathione *S*-transferase activity (Okine *et al.*, 1985; Cossec *et al.*, 1996), nutritional status (fasting and nonfasting), and changes in CYP2E1 are important factors. Inducers and inhibitors of CYP2E1 alter metabolic activation of vinylidene chloride to reactive intermediates (Short *et al.*, 1977a; Kainz *et al.*, 1993; Lee and Forkert, 1994; Dowsley *et al.*, 1995). In rodents, vinylidene chloride epoxide and 2-chloroacetylchloride are proposed as the reactive intermediates which are subsequently detoxified via the reaction with glutathione and produced in the liver following exposure. These electrophilic intermediates are also capable of reacting with cellular macromolecules to form adducts in the liver, which may partially explain the observed liver toxicity in rodents. The glutathione

conjugates are secreted from the hepatocytes and delivered to the kidney where they undergo glomerular filtration (Dekant *et al.*, 1988). In the kidney, glutathione conjugates may be metabolized to the corresponding cysteine conjugate, which is acetylated and excreted in urine. Alternately, glutathione conjugates can be metabolized by  $\beta$ -lyase, an enzyme located in the renal proximal tubule, to release an electrophilic product that can subsequently interact with cellular macromolecules in the kidney. This mechanism has been shown to be associated with the observed nephrotoxicity of other halogenated ethylenes and ethanes (Lash *et al.*, 2000). It has been shown that fasting significantly reduces detoxification and enhances covalent binding of toxic metabolites in the liver and kidney (Jaeger *et al.*, 1974, 1977; McKenna *et al.*, 1977, 1978a).

## Humans

No studies are available for the disposition of vinylidene chloride in humans. In human liver and lung microsomal incubations, epoxide-derived glutathione conjugates were the major metabolites detected along with low levels of 2,2,-dichloroacetaldehyde (Dowsley *et al.*, 1999). Liver microsomes from three out of five human samples metabolized vinylidene chloride to the epoxide-derived glutathione conjugates. Studies using human recombinant enzymes have demonstrated the involvement of CYP2E1 in vinylidene chloride metabolism in humans (Simmonds *et al.*, 2004).

## TOXICITY

### Experimental Animals

Vinylidene chloride toxicity, including lethality, varies considerably with species, sex, strain, and nutritional status. Mice are more sensitive than rats to vinylidene chloride toxicity. The oral LD<sub>50</sub> ranges from 1,500 to 1,800 mg/kg in rats (Jenkins *et al.*, 1972; Ponomarkov and Tomatis, 1980) compared to 194 to 217 mg/kg in mice (Jones and Hathway, 1978b). The reported values for inhalation LC<sub>50</sub> are 6,350 ppm in rats (Siegel *et al.*, 1971) and 98 to 105 ppm in mice (Short *et al.*, 1977b).

A major contributing factor to the variability of vinylidene chloride toxicity involves food intake (fasted/nonfasted). Lethal inhalation concentrations for fed rats are higher than those in fasted rats (Siegel *et al.*, 1971; Jaeger *et al.*,

1973, 1974). Vinylidene chloride toxicity is enhanced in fasted animals (Jaeger *et al.*, 1974, 1975a; Andersen and Jenkins, 1977; Moslen *et al.*, 1985) and in glutathione-depleted rats and mice (Jaeger *et al.*, 1974; Andersen *et al.*, 1980; Siegers *et al.*, 1985; Kanz *et al.*, 1988; Moussa and Forkert, 1992). Toxicity is decreased when the capacity of P450 metabolic activation is decreased (Andersen *et al.*, 1978; Moslen *et al.*, 1989).

In short-term studies in laboratory animals, the liver and kidney are the main target organs of vinylidene chloride-induced toxicity. Vinylidene chloride suppresses liver glutathione levels (Reichert *et al.*, 1978; Reynolds *et al.*, 1980; Forkert and Moussa, 1991, 1993) and induces hepatotoxicity. Exposure to vinylidene chloride increases serum markers for liver damage and hepatic histopathologic lesions, including hepatocellular degeneration, necrosis, and bile duct hyperplasia (Short *et al.*, 1977b; Jenkins and Andersen, 1978; Reynolds *et al.*, 1980). Exposure to vinylidene chloride increases kidney weights and serum markers for nephrotoxicity and induces histopathologic lesions, including tubular dilation and necrosis in rats (Jenkins and Andersen, 1978; Jackson and Conolly, 1985) and mice (Short *et al.*, 1977b). Vinylidene chloride-mediated renal toxicity correlates to metabolic activation by CYP2E1 in the proximal tubules, decreased glutathione concentrations, and increased covalent binding in the kidney. In the kidneys, glutathione conjugates and/or their derivatives may undergo secondary modification by  $\beta$ -lyase to reactive metabolites (Ban *et al.*, 1995; Cavelier *et al.*, 1996). In mice, exposure to vinylidene chloride has also been shown to induce morphologic changes in Clara cells, including dilation of cisternae, endoplasmic reticulum degeneration, and cytoplasmic vacuolization (Forkert and Reynolds, 1982).

The National Toxicology Program (NTP) previously conducted 14-day, 13-week subchronic toxicology, and 2-year chronic toxicology and carcinogenesis studies for vinylidene chloride administered via gavage to F344 rats and B6C3F<sub>1</sub> mice (NTP, 1982). In the 14-day studies, decreased survival was observed at 500 and 1,000 mg/kg in rats and 500 mg/kg in mice. Hemorrhagic necrosis in the liver corresponded with increased mortality in both rats and mice. In rats, significantly decreased body weights were also observed at these doses. In the 13-week studies, decreased mean body weights and increased incidences of hepatocytomegaly and hepatic centrilobular necrosis were observed in rats exposed to 250 mg/kg. Hepatocytomegaly with less severity was also observed at 100 mg/kg. In mice, increased mortality in both sexes exposed to 250 mg/kg was associated with necrosis, hemorrhage, and congestion of the liver. At 100 mg/kg, survival was slightly decreased (8/10 males; 7/10 females) and increased

incidences of cellular atypia of the liver were observed in males and females. A dose-dependent decrease in mean body weight gain was observed in male mice.

## Humans

In humans, vinylidene chloride is an irritant and a central nervous system depressant, and it induces toxicity in liver, lung, and kidney (Torkelson, 1994; USEPA, 2002). The irritant properties have been attributed to the polymerization inhibitor MEHQ (IARC, 1999; USEPA, 2002).

## REPRODUCTIVE AND DEVELOPMENTAL TOXICITY

In studies assessing reproduction, exposure to vinylidene chloride via inhalation or drinking water had no effects on reproduction in male mice or in either sex of rats (Anderson *et al.*, 1977; Short *et al.*, 1977c; Nitschke *et al.*, 1983). No evidence of maternal toxicity or teratogenic effects was observed in rats exposed to 200 ppm vinylidene chloride on gestation days 6 to 15 in the drinking water (Murray *et al.*, 1979). In inhalation studies, maternal toxicity was observed at 15 ppm or greater in CD-1 rats, 30 ppm or greater in CD-1 mice, 80 ppm or greater in Sprague-Dawley rats, and 160 ppm or greater in New Zealand white rabbits (Short *et al.*, 1977a; Murray *et al.*, 1979). In these studies, inhalation exposure to vinylidene chloride during gestation clearly induced embryo- and fetotoxicity at concentrations that induced maternal toxicity. In CD-1 mice, fetal toxicity in the absence of significant maternal toxicity was observed at 15 ppm vinylidene chloride. In this study, there was an increase in fetuses with an unossified incus, incompletely ossified sternebrae, hydrocephalus, occluded nasal passages, microphthalmia, cleft palate, small liver, and hydronephrosis.

## CARCINOGENICITY

### Experimental Animals

The chronic toxicity and carcinogenicity of vinylidene chloride in rats and mice have been investigated in eight rat and three mouse inhalation studies and five rat and one mouse oral studies (Lee *et al.*, 1977, 1978; Viola and Caputo, 1977; Ponomarev and Tomatis, 1980; Hong *et al.*, 1981; NTP, 1982; Quast *et al.*, 1983; Maltoni *et al.*, 1985; Cotti *et al.*, 1988). Overall, none of the results from these studies demonstrate a significant increase in



neoplasms following exposure to vinylidene chloride. Despite this broad database of research from other published studies, these studies are insufficient for determining the carcinogenic risk. Problems associated with the results from these studies include the lack of statistical analysis, inadequate control of dosing or exposure, changing or discontinuing dosing or exposure levels during the study, excessive mortality, inadequate study duration or overall study design, and a lack of dose response.

In the previous NTP (1982) studies, no significant effects were observed on survival, clinical signs, or body weights in rats or mice administered vinylidene chloride by gavage. When rats were administered 1 or 5 mg/kg, the incidence of chronic inflammation of the kidney was higher in 5 mg/kg males than in the vehicle controls. There was no increased incidence of neoplasms at any site in rats administered vinylidene chloride. When mice were administered 2 or 10 mg/kg, a significant increase in the incidence of lymphoma or leukemia at 2 mg/kg that was not observed at 10 mg/kg was not considered to be related to vinylidene chloride administration in females. There was no increased incidence of neoplasms at any other site in male or female mice administered vinylidene chloride.

## Humans

Major limitations in the two cohort studies conducted in vinylidene chloride-exposed workers restrict the value of the results. No specific association has been found between exposure to vinylidene chloride in a synthetic chemical plant and excess cancer (IARC, 1999).

## GENETIC TOXICITY

The literature suggests that vinylidene chloride, which is a gas at temperatures above 31.7° C, demonstrates consistent mutagenic activity *in vitro* when tests are conducted with an exogenous metabolic activation system. No evidence of genotoxicity was seen in the few *in vivo* assays that were reported for vinylidene chloride.

Increases in mutant colonies were observed in *Salmonella typhimurium* strains TA100 and TA1530 following exposure to vinylidene chloride concentrations of 0.2%, 2%, and 20% in air (v/v) in the closed environment of a desiccator in the presence of noninduced rat or mouse liver microsomal mix (S9) (Bartsch *et al.*, 1975); mutagenicity was greater in the presence of mouse S9. Mouse kidney and lung S9 fractions were also effective at

producing mutagenic metabolites of vinylidene chloride in strain TA100, although the responses were lower than those observed with liver S9 activation (Bartsch *et al.*, 1975). Strongly positive results were also observed in *S. typhimurium* strains TA92, TA98, TA100, and TA1537 and *Escherichia coli* strain WP2 *uvrA* exposed to vinylidene chloride (375 to 22,500 ppm) in the presence of noninduced mouse liver S9 in a sealed desiccator (Oesch *et al.*, 1983). In this study, the effectiveness of vinylidene chloride-induced mouse liver S9 and rat liver S9 was examined, and no additional increase in mutagenicity was observed compared with use of the noninduced S9.

Other studies of the effect of S9 preparation from different species on the mutagenicity of vinylidene chloride (5% in air, sealed culture system) in *S. typhimurium* strain TA1535 demonstrated that pretreatment with Aroclor 1254 increased the effectiveness of mouse liver and kidney S9, and that induced mouse liver S9 was more effective than induced rat liver S9 at generating mutagenic metabolites of vinylidene chloride (Jones and Hathway, 1978c).

Vinylidene chloride (3%) has also been used as a positive control for strains TA100 and TA1530 in experiments conducted in a closed environment, in the presence of metabolic activation, with gaseous test agents (Baden *et al.*, 1978). The need to control for volatility is demonstrated by the failure of vinylidene chloride (tested up to 6,667 µg/mL) to induce revertants in *S. typhimurium* strains TA98, TA100, TA1535, or TA1537, with or without S9, when a preincubation protocol was employed (Mortelmans *et al.*, 1986).

Consistent with the other studies in bacteria, vinylidene chloride (2.5 mM) induced a mutagenic response in *E. coli* K-12 in the presence, but not the absence, of mouse S9 (Greim *et al.*, 1975; Henschler, 1977).

In yeast test systems, vinylidene chloride was shown to be toxic but not mutagenic in the diploid *Saccharomyces cerevisiae* strain D7 in the absence of S9 (Koch *et al.*, 1988). However, in the presence of Aroclor 1254-induced mouse liver S9, dose-related increases in both point mutations and mitotic gene conversions were seen in strain D7 at doses above 20 mM (Bronzetti *et al.* 1981; Koch *et al.*, 1988). Significant increases in mitotic gene conversion were also seen in logarithmic phase *S. cerevisiae* D7 cells with a high level of cytochrome P450 that provided for metabolic activation of vinylidene chloride (Koch *et al.*, 1988). Vinylidene chloride induced a highly significant, dose-related increase in aneuploidy in *S. cerevisiae* strain D61.M, with and without S9 (Koch *et al.*, 1988).

Inconsistent mutagenic responses were seen in L5178Y mouse lymphoma *tk<sup>+/+</sup>* cells with vinylidene chloride in the absence of metabolic activation; with activation, both cytotoxicity and mutagenicity were consistently positive at concentrations of 0.16% and above in repeat experiments (McGregor *et al.*, 1991). Concentrations of 2% or 10% vinylidene chloride by air (5 hour exposure) with or without S9 mix did not increase resistance to ovabain (membrane sodium-potassium ATPase locus) or  $\gamma$ -azocytidine (HGPRT locus) in Chinese hamster V9 cells (Drevon and Kuroki, 1979).

Dose-related increases in chromosomal aberrations were seen in cultured Chinese hamster lung cells exposed to vinylidene chloride over a concentration range of 0.125 to 1.5 mg/mL in the presence of 15% PCB-induced male F344 rat liver S9 (Sawada *et al.*, 1987). In addition, sister chromatid exchanges were increased in these same cells when treatment was carried out in the presence of S9.

Limited evidence of genotoxicity was seen with vinylidene chloride *in vivo*. Bone marrow micronucleus tests in ddY male mice following single (25 to 200 mg/kg) or multiple (25 to 100 mg/kg) daily gavage treatments with vinylidene chloride were negative, and no increases in micronucleated cells of fetal liver or fetal blood were seen 24 hours after a single intraperitoneal injection (25 to 100 mg/kg) administered to pregnant ICR mice on gestational day 18 (Sawada *et al.*, 1987). Negative results were also reported in dominant lethal tests (germ cell mutagenicity assays) in male CD-1 mice treated with 3,000 to 30,000 ppm vinylidene chloride 6 hours/day for 5 days followed by mating (Anderson *et al.*, 1977), and male CD rats exposed to 55 ppm vinylidene chloride for at least 11 weeks prior to mating (Short *et al.*, 1977c). However, evidence of vinylidene chloride interaction with DNA was seen in one study in which alkylated DNA was recovered from the livers and kidneys of mice and rats exposed to radiolabeled vinylidene chloride (10 or 50 ppm for 6 hours), although the number of alkylated nucleotides recovered was very low compared to those recovered after intraperitoneal dosing with 10 mg/kg of the potent alkylating agent dimethylnitrosamine (Reitz *et al.*, 1980).

## STUDY RATIONALE

The toxicology and carcinogenicity of inhaled vinylidene chloride were investigated based on insufficient critical information concerning its health effects and the need to fill critical data gaps. Previously conducted NTP (1982) studies were considered insufficient to evaluate carcinogenicity because selected doses failed to include a maximum tolerated dose. The conclusion of these studies was that the lack of carcinogenicity observed should not be taken as proof that vinylidene chloride was not a carcinogen.

## MATERIALS AND METHODS

### PROCUREMENT AND CHARACTERIZATION OF VINYLIDENE CHLORIDE

Vinylidene chloride, manufactured by Dow Chemical Company (Freeport, TX), was obtained in one lot from Sigma-Aldrich and was used in the 2-week, 3-month, and 2-year studies. The material was identified as lot SB20019301. Identity and purity analyses were conducted by the analytical chemistry laboratory at Chemir Pharma Services (Maryland Heights, MO) and the study laboratory at Battelle Toxicology Northwest (Richland, WA) (Appendix I). Reports on analyses performed in support of the vinylidene chloride studies are on file at the National Institute of Environmental Health Sciences.

The chemical, a colorless, low viscosity liquid with a sweet odor, was identified as vinylidene chloride by infrared and proton nuclear magnetic resonance spectroscopy. Purity of lot SB20019301 was determined by elemental analyses, Karl Fisher titration, anion exchange chromatography, a potassium iodide (KI) titration, a turbidity assay, and gas chromatography with flame ionization detection (GC/FID). Elemental analyses for carbon and hydrogen were consistent with theoretical values for vinylidene chloride. Karl Fischer titration indicated a water content of 74 ppm. KI titration indicated that peroxide was less than 1 ppm by weight as active oxygen compared to vinylidene chloride. Anion exchange chromatography indicated that residual chloride content was less than 2 ppm. The turbidity assay showed that the concentration of polymer was less than 9 ppm. GC/FID indicated that the test article was stabilized with approximately 300 ppm monomethyl ether of hydroquinone (MEHQ). Purity analysis by GC/FID indicated the overall purity of lot SB20019301 was greater than 99.9%.

To ensure stability, the bulk chemical was stored under a nitrogen headspace in the original shipping containers (400-L steel mini-Bulk™ containers) at a temperature of approximately 63° F. Periodic reanalyses of the bulk chemical were performed during the 2-week, 3-month, and 2-year studies by the study laboratory using the same turbidity and GC/FID assays used in the initial bulk chemical purity assays, and no degradation of the bulk chemical was detected.

## VAPOR GENERATION AND EXPOSURE SYSTEM

Vinylidene chloride was pumped from a disposable 4 liter amber glass generator reservoir into a heated glass flask. Nitrogen entered the flask and assisted in vaporizing the chemical while conveying it from the generator into a short vapor distribution manifold. Concentration in the manifold was determined by the chemical pump and nitrogen flow rates. Pressure in the distribution manifold was kept fixed to ensure constant flows through the manifold and into all chambers as the flow of vapor to each chamber was adjusted.

Individual Teflon<sup>®</sup> delivery lines carried the vapor from the manifold to three-way exposure valves at the chamber inlets. The exposure valves diverted vapor delivery to the exposure chamber exhaust until the generation system stabilized and exposure could proceed. The flow rate to each chamber was controlled by a metering valve at the manifold. To initiate exposure, the chamber exposure valves were rotated to allow the vinylidene chloride vapor to flow to each exposure chamber inlet duct where it was diluted with conditioned chamber air to achieve the desired exposure concentration.

The study laboratory designed the inhalation exposure chamber so that uniform vapor concentrations could be maintained throughout the chamber with the catch pans in place. The total active mixing volume of each chamber was 1.7 m<sup>3</sup>. A small particle detector was used with and without animals in the exposure chambers to ensure that vinylidene chloride vapor, and not aerosol, was produced. No particle counts above the minimum resolvable level (approximately 200 particles/cm<sup>3</sup>) were detected.

## VAPOR CONCENTRATION MONITORING

Chamber and room concentrations of vinylidene chloride were monitored by an on-line gas chromatograph. Samples were drawn from each exposure chamber approximately three times (2-week and 3-month studies) or twice (2-year studies) per hour during each 6-hour exposure period using Hastelloy<sup>®</sup>-C stream-select and gas-sampling valves in a separate, heated oven. The sample lines composing each sample loop were made from Teflon<sup>®</sup> tubing and were connected to the exposure chamber relative humidity sampling lines at a location close to the gas chromatograph. A vacuum regulator maintained a constant vacuum in the sample loop to compensate for variations

in sample line pressure. An in-line flow meter between the vacuum regulator and the gas chromatograph allowed digital measurement of sample flow.

The on-line gas chromatograph was checked throughout each exposure day for instrument drift against an on-line standard vapor of methylene chloride in nitrogen supplied by a standard generator. The on-line gas chromatograph was recalibrated as required to meet acceptance criteria. Calibration was performed by a comparison of chamber concentration data to data from grab samples collected with activated coconut charcoal gas sampling tubes, extracted with toluene containing an internal standard of methylene chloride and analyzed using an off-line gas chromatograph equipped with an electron capture detector. Known volumes of chamber atmosphere were sampled at a constant flow rate ensured by a calibrated critical orifice. The off-line gas chromatograph was calibrated with gravimetrically prepared standard solutions of the test chemical containing methylene chloride as an internal standard in toluene.

## CHAMBER ATMOSPHERE CHARACTERIZATION

Buildup and decay rates for chamber vapor concentrations were determined with (all studies) and without (3-month and 2-year studies) animals present in the chambers. At a chamber airflow rate of 15 air changes per hour, the theoretical value for the time to achieve 90% of the target concentration after the beginning of vapor generation ( $T_{90}$ ) and the time for the chamber concentration to decay to 10% of the target concentration after vapor generation was terminated ( $T_{10}$ ) was approximately 9.4 minutes. Based on experimental data, a  $T_{90}$  value of 12 minutes was selected for the 2-week studies and a  $T_{90}$  value of 10 minutes was selected for the 3-month and 2-year studies.

The uniformity of vinylidene chloride vapor concentration in the inhalation exposure chambers without animals present was evaluated before the 3-month and 2-year studies began; in addition, concentration uniformity with animals present in the chambers was measured once during the 2-week studies, once during the 3-month studies, and approximately quarterly during the 2-year studies. The vapor concentration was measured using the on-line gas chromatograph. Chamber concentration uniformity was maintained throughout the studies.

The persistence of vinylidene chloride in the chambers after vapor delivery ended was determined by monitoring the vapor concentration in the 400 ppm chambers in the 2-week studies, the 100 ppm chambers in the 3-month studies, and the 100 ppm rat and 25 ppm mouse chambers in the 2-year studies with (all studies) and without (3-month and 2-year studies) animals present in the chambers. In the 2-week studies, the concentration decreased to 1% of the target concentration within 21 minutes with animals present. In the 3-month studies, the concentration decreased to 1% of the target concentration within 21 minutes without animals present and within 23 minutes with animals present. For the 2-year rat studies, the concentration decreased to 1% of the target concentration within 22 minutes with and without animals present; for mice, the concentration decreased to 1% of the target concentration within 18 minutes without animals present and within 21 minutes with animals present.

Samples of the test atmosphere from the distribution lines and the low and high exposure concentration chambers for each species were collected prior to the study without animals present (3-month and 2-year studies) and at the beginning and end of one generation day with animals present during the 2-week, 3-month, and 2-year studies. Additional samples were collected from the generator reservoir, and all of the samples were analyzed using GC/FID to measure the stability and purity of vinylidene chloride in the generation and delivery system. To assess whether impurities or degradation products co-eluted with vinylidene chloride or the solvent, a second GC/FID analysis of the samples was performed using a polar column capable of resolving compounds with similar boiling points and polarities. Separate atmosphere samples were collected in these studies using toluene bubblers; MEHQ inhibitor was assayed in these distribution line samples using GC/FID, and peroxide was assayed in these distribution line and low (except 2-week studies) and high exposure concentration chamber samples by KI titration. Hydrochloric acid, formaldehyde, and phosgene concentrations were measured in atmosphere samples collected during the last 2 hours of a 6-hour generation day. Fourier transform IR spectroscopy was used to measure the presence of HCL in samples collected prior to the 3-month studies and during the 2-week, 3-month, and 2-year studies. Formaldehyde and phosgene were measured in atmosphere samples collected on silica adsorbent sampling tubes coated with 2,4-dinitrophenylhydrazine prior to the 3-month and 2-year studies and during the 2-week, 3-month, and 2-year studies. These samples were analyzed using a liquid chromatography procedure. Samples were collected from the generator reservoir 3 to 14 days after the reservoir was placed in use in studies conducted without animals present prior to the 3-month and 2-year studies and at the same timepoints during the 2-week, 3-month, and 2-year studies.



These samples were analyzed for area percent purity, polymer formation, peroxide content, and MEHQ concentration using the same methodologies employed for the initial bulk chemical characterization assays.

No evidence of degradation of vinylidene chloride was noted in any part of the exposure system in any of the samples collected prior to the 3-month and 2-year studies or during the 2-week, 3-month, and 2-year studies. No impurity peaks with areas greater than 0.1% of the total peak area were detected in atmosphere or generator reservoir samples, and no additional impurities were found in any of the atmosphere or reservoir samples using the polar column. HCL concentrations in the atmosphere samples were consistently less than the detection limit. Formaldehyde and phosgene concentrations were less than 0.1% by weight compared to vinylidene chloride in all distribution line and chamber atmosphere samples. Acceptable, low concentrations of peroxide as active oxygen relative to vinylidene chloride were found in all atmosphere samples. All distribution line samples contained concentrations within the acceptable range for the inhibitor MEHQ relative to vinylidene chloride. No evidence of degradation, peroxide formation, or polymer formation was noted in any of the samples taken from the generator reservoir after multiple days of use.

## **ANIMAL SOURCE**

Male and female F344/N rats and B6C3F1/N mice were obtained from the NTP colony maintained at Taconic Farms, Inc. (Germantown, NY), for use in the 2-week, 3-month, and 2-year studies.

## **2-WEEK STUDIES**

On receipt, the rats and mice were 4 weeks old. Animals were quarantined for 11 days and were 6 weeks old on the first day of the studies. Before the studies began, five male and five female rats and mice were randomly selected for parasite evaluation and gross observation for evidence of disease. At the end of the studies, serologic analyses were performed on five male and five female chamber control rats and mice using the protocols of the NTP Sentinel Animal Program (Appendix K).

Groups of five male and five female rats and mice were exposed by whole body inhalation to vinylidene chloride vapor at concentrations of 0, 25, 50, 100, 200, or 400 ppm, 6 hours plus T<sub>90</sub> (12 minutes) per day, 5 days per week for 16 (rats) or 17 (mice) days. These wide-ranging exposure concentrations were selected based on reports in the literature that indicated significant differences in species- and strain-related sensitivity to the toxicity of vinylidene chloride. Feed was available *ad libitum* except during exposure periods; water was available *ad libitum*. Rats and mice were housed individually. Clinical findings were recorded daily before and after exposure and at the end of the studies. The animals were weighed initially, on days 6 and 13, and at the end of the studies. Details of the study design and animal maintenance are summarized in Table 1.

At the end of the 2-week studies, necropsies were performed on all rats and mice. The heart, right kidney, liver, lung, right testis, and thymus were weighed. Histopathologic examinations were performed on 0, 100, 200, and 400 ppm rats and 0, 50, 100, 200, and 400 ppm mice; the eyes, kidney (except 50 ppm female mice), liver, lung, and nose were examined. Table 1 lists the tissues and organs examined.

### 3-MONTH STUDIES

The 3-month studies were conducted to evaluate the cumulative toxic effects of repeated exposure to vinylidene chloride and to determine the appropriate exposure concentrations to be used in the 2-year studies.

On receipt, the rats were 4 weeks old, and the mice were 3 or 4 weeks old. Animals were quarantined for 12 or 13 days and were 5 to 6 weeks old on the first day of the studies. Before the studies began, five male and five female rats and mice were randomly selected for parasite evaluation and gross observation for evidence of disease. During week 2 and at the end of the studies, serologic analyses were performed on five male and five female sentinel rats and mice using the protocols of the NTP Sentinel Animal Program (Appendix K).

Groups of 10 male and 10 female rats and mice were exposed by whole body inhalation to vinylidene chloride vapor at concentrations of 0, 6.25, 12.5, 25, 50, or 100 (rats and female mice) ppm, 6 hours plus T<sub>90</sub> (10 minutes) per day, 5 days per week for 14 weeks. Groups of 10 male and 10 female clinical pathology rats were exposed to the same concentrations for 23 days. Feed was available *ad libitum* except during exposure periods; water was available

*ad libitum*. Rats and mice were housed individually. Clinical findings were recorded on day 9 (female rats) or day 10, weekly thereafter, and at the end of the studies. The animals were weighed initially, day 9 (female rats) or day 10, weekly thereafter, and at the end of the studies. Details of the study design and animal maintenance are summarized in Table 1.

Blood was collected from the retroorbital sinus of clinical pathology rats on days 3 and 23 and from core study rats and mice at the end of the studies for hematology and clinical chemistry (rats only) analyses. For the hematology samples, blood was collected in a tube (Vacutainer, Becton Dickenson; Franklin Lakes, NJ) containing potassium-EDTA; for the clinical chemistry samples, the blood was collected in a tube devoid of anticoagulant but containing a separator gel for serum. An Abbott Cell-Dyn 3700 (Abbott Diagnostics Systems, Abbott Park, IL) was used to determine packed cell volume; hemoglobin concentration; erythrocyte, platelet, and leukocyte counts; mean cell volume; mean cell hemoglobin; and mean cell hemoglobin concentration. Manual hematocrit values were determined using a microcentrifuge (Heraeus haemofuge, Germany) and a Damon/IEC capillary reader (International Equipment Company, Needham Heights, MA) for comparison to Cell-Dyn values for packed cell volume. Leukocyte, erythrocyte, and platelet morphology were assessed on blood smears stained with Romanowsky-type aqueous stain in a Wescor 7100 slide stainer (Wescor, Inc., Logan UT), and when observed, nucleated erythrocytes were counted per 100 leukocytes from the same stained blood smear. Reticulocytes were stained supravivally with new methylene blue and enumerated as reticulocytes per 1,000 erythrocytes using the Miller disc method (Brecher and Schneiderman, 1950). Howell-Jolly bodies were counted per 1,000 erythrocytes. For clinical chemistry analyses, serum samples were analyzed using a Roche Hitachi 912 System (Roche Diagnostic Corporation, Indianapolis, IN). The hematology and clinical chemistry parameters measured are listed in Table 1.

At the end of the 3-month studies, samples were collected for sperm motility and vaginal cytology evaluations on rats exposed to 0, 25, 50, or 100 ppm and mice exposed to 0, 12.5, 25, or 50 ppm. The parameters evaluated are listed in Table 1. For 12 consecutive days prior to scheduled terminal kill, the vaginal vaults of the females were moistened with saline, if necessary, and samples of vaginal fluid and cells were stained. Relative numbers of leukocytes, nucleated epithelial cells, and large squamous epithelial cells were determined and used to ascertain estrous cycle stage (i.e., diestrus, proestrus, estrus, and metestrus). Male animals were evaluated for sperm count

and motility. The left testis and left epididymis were isolated and weighed. The tail of the epididymis (cauda epididymis) was then removed from the epididymal body (corpus epididymis) and weighed. Test yolk (rats) or modified Tyrode's buffer (mice) was applied to slides and a small incision was made at the distal border of the cauda epididymis. The sperm effluxing from the incision were dispersed in the buffer on the slides, and the numbers of motile and nonmotile spermatozoa were counted for five fields per slide by two observers. Following completion of sperm motility estimates, each left cauda epididymis was placed in buffered saline solution. Caudae were finely minced, and the tissue was incubated in the saline solution and then heat fixed at 65° C. Sperm density was then determined microscopically with the aid of a hemacytometer. To quantify spermatogenesis, the testicular spermatid head count was determined by removing the tunica albuginea and homogenizing the left testis in phosphate-buffered saline containing 10% dimethyl sulfoxide. Homogenization-resistant spermatid nuclei were counted with a hemacytometer.

Necropsies were performed on all core study animals. The heart, right kidney, liver, lungs, right testis, and thymus were weighed. Tissues for microscopic examination were fixed and preserved in 10% neutral buffered formalin (except eyes were first fixed in Davidson's solution), processed and trimmed, embedded in paraffin, sectioned to a thickness of 4 to 6 µm, and stained with hematoxylin and eosin. Complete histopathologic examinations were performed by the study laboratory pathologist on 0 and 100 ppm core study rats and 0, 50 (male), and 100 (female) ppm mice. Table 1 lists the tissues and organs routinely examined.

After a review of the laboratory reports and selected histopathology slides by a quality assessment (QA) pathologist, the findings and reviewed slides were submitted to a NTP Pathology Working Group (PWG) coordinator for a second independent review. Any inconsistencies in the diagnoses made by the study laboratory and QA pathologists were resolved by the NTP pathology peer review process. Final diagnoses for reviewed lesions represent a consensus of the PWG or a concensus between the study laboratory pathologist, NTP pathologist, QA pathologist(s), and the PWG coordinator. Details of these review procedures have been described, in part, by Maronpot and Boorman (1982) and Boorman *et al.* (1985).

## 2-YEAR STUDIES

### Study Design

Groups of 50 male and 50 female rats and mice were exposed by whole body inhalation to vinylidene chloride vapor at concentrations of 0, 25, 50, or 100 (rats) or 0, 6.25, 12.5, or 25 (mice) ppm, 6 hours plus T<sub>90</sub> (10 minutes) per day, 5 days per week for 105 weeks.

### Animal Maintenance

Animal care and use are in accordance with the Public Health Service Policy on Humane Care and Use of Animals. All animal studies were conducted in an animal facility accredited by the Association for the Assessment and Accreditation of Laboratory Animal Care International. Studies were approved by the study laboratory (Battelle Toxicology Northwest) Animal Care and Use Committee and conducted in accordance with all relevant NIH and NTP animal care and use policies and applicable federal, state, and local regulations and guidelines. The health of the animals was monitored during the studies according to the protocols of the NTP Sentinel Animal Program (Appendix K).

Rats and mice were quarantined for 12 days before the beginning of the studies. Five male and five female rats and mice were randomly selected for parasite evaluation and gross observation of disease. Rats were 6 weeks old and mice were 5 to 6 weeks old at the beginning of the studies.

Rats and mice were housed individually. Feed was available *ad libitum* except during exposure periods; water was available *ad libitum*. Chambers and racks were rotated weekly. Further details of animal maintenance are given in Table 1. Information on feed composition and contaminants is provided in Appendix J.

### Clinical Examinations and Pathology

All animals were observed twice daily. Body weights were recorded on day 1, weekly for the first 13 weeks, every 4 weeks through week 93, every 2 weeks thereafter, and at terminal kill. Clinical findings were recorded every 4 weeks through week 93, then every 2 weeks, and at terminal kill.

Complete necropsies and microscopic examinations were performed on all core study rats and mice. At necropsy, all organs and tissues were examined for grossly visible lesions, and all major tissues were fixed and preserved in 10% neutral buffered formalin (except eyes were first fixed in Davidson's Solution), processed and trimmed, embedded in paraffin, sectioned to a thickness of 4 to 6  $\mu\text{m}$ , and stained with hematoxylin and eosin for microscopic examination. For all paired organs (e.g., adrenal gland, kidney, ovary), samples from each organ were examined. For extended evaluation of renal proliferative lesions, kidneys were step sectioned at 1 mm intervals from the residual cross sectional half of the right kidney and the longitudinal half of the left kidney of male rats, and four additional sections were obtained from each kidney. Tissues examined microscopically are listed in Table 1. Samples of tumor tissues collected at necropsy for molecular analysis (mesotheliomas) were flash frozen in liquid nitrogen and stored at  $-80^{\circ}\text{C}$  (Appendix L).

Microscopic evaluations were completed by the study laboratory pathologist, and the pathology data were entered into the Toxicology Data Management System. The report, slides, paraffin blocks, residual wet tissues, and pathology data were sent to the NTP Archives for inventory, slide/block match, wet tissue audit, and storage. The slides, individual animal data records, and pathology tables were evaluated by an independent quality assessment laboratory. The individual animal records and tables were compared for accuracy, the slide and tissue counts were verified, and the histotechnique was evaluated. For the 2-year studies, a quality assessment pathologist evaluated slides from all tumors and all potential target organs, which included the nose of rats and mice, the kidney of male rats and male and female mice, and the liver of rats.

The quality assessment report and the reviewed slides were submitted to the NTP PWG coordinator, who reviewed the selected tissues and addressed any inconsistencies in the diagnoses made by the laboratory and quality assessment pathologists. Representative histopathology slides containing examples of lesions related to chemical administration, examples of disagreements in diagnoses between the laboratory and quality assessment pathologists, or lesions of general interest were presented by the coordinator to the PWG for review. The PWG consisted of the quality assessment pathologist and other pathologists experienced in rodent toxicologic pathology. This group examined the tissues without any knowledge of dose groups. When the PWG consensus differed from the opinion of the laboratory pathologist, the diagnosis was changed. Final diagnoses for reviewed lesions represent a consensus

between the laboratory pathologist, reviewing pathologist(s), and the PWG. Details of these review procedures have been described, in part, by Maronpot and Boorman (1982) and Boorman *et al.* (1985). For subsequent analyses of the pathology data, the decision of whether to evaluate the diagnosed lesions for each tissue type separately or combined was generally based on the guidelines of McConnell *et al.* (1986).

**TABLE 1**  
**Experimental Design and Materials and Methods in the Inhalation Studies of Vinylidene Chloride**

<b>2-Week Studies</b>	<b>3-Month Studies</b>	<b>2-Year Studies</b>
<b>Study Laboratory</b> Battelle Toxicology Northwest (Richland, WA)	Battelle Toxicology Northwest (Richland, WA)	Battelle Toxicology Northwest (Richland, WA)
<b>Strain and Species</b> F344/N rats B6C3F1/N mice	F344/N rats B6C3F1/N mice	F344/N rats B6C3F1/N mice
<b>Animal Source</b> Taconic Farms, Inc. (Germantown, NY)	Taconic Farms, Inc. (Germantown, NY)	Taconic Farms, Inc. (Germantown, NY)
<b>Time Held Before Studies</b> 11 days	Rats: 12 (males) or 13 (females) days Mice: 12 days	12 days
<b>Average Age When Studies Began</b> 6 weeks	Rats: 6 weeks Mice: 5 to 6 weeks	Rats: 6 weeks Mice: 5 weeks
<b>Date of First Exposure</b> June 14, 2004	Rats: October 11 (males) or 12 (females), 2004 Mice: October 11, 2004	Rats: June 6, 2005 Mice: June 20, 2005
<b>Duration of Exposure</b> 6 hours plus T <sub>90</sub> (12 minutes) per day, 5 days per week for 16 (rats) or 17 (mice) days	6 hours plus T <sub>90</sub> (10 minutes) per day, 5 days per week, for 14 weeks	6 hours plus T <sub>90</sub> (10 minutes) per day, 5 days per week, for 105 weeks
<b>Date of Last Exposure</b> Rats: June 29, 2004 Mice: June 30, 2004	Rats: January 10 (males) or 11 (females), 2005 Mice: January 12 (males) or 13 (females), 2005	Rats: June 7, 2007 Mice: June 21, 2007
<b>Necropsy Dates</b> Rats: June 30, 2004 Mice: July 1, 2004	Rats: January 11 (males) or 12 (females), 2005 Mice: January 13 (males) or 14 (females), 2005	Rats: June 4-8, 2007 Mice: June 18-22, 2007
<b>Average Age at Necropsy</b> 8 weeks	Rats: 19 weeks Mice: 19 to 20 weeks	110 weeks
<b>Size of Study Groups</b> 5 males and 5 females	10 males and 10 females	50 males and 50 females

**TABLE 1**  
**Experimental Design and Materials and Methods in the Inhalation Studies of Vinylidene Chloride**

2-Week Studies	3-Month Studies	2-Year Studies
<b>Method of Distribution</b> Animals were distributed randomly into groups of approximately equal initial mean body weights.	Same as 2-week studies	Same as 2-week studies
<b>Animals per Cage</b> 1	1	1
<b>Method of Animal Identification</b> Tail tattoo	Tail tattoo	Tail tattoo
<b>Diet</b> Irradiated NTP-2000 open formula wafers (Zeigler Brothers, Inc., Gardners, PA), available <i>ad libitum</i> except during exposure periods, changed weekly	Same as 2-week studies	Same as 2-week studies
<b>Water</b> Tap water (Richland, WA, municipal supply) via automatic watering system (Edstrom Industries, Waterford, MI), available <i>ad libitum</i>	Same as 2-week studies	Same as 2-week studies
<b>Cages</b> Stainless steel wire-bottom (Lab Products, Inc., Seaford, DE), changed weekly with chambers, rotated daily in chambers	Same as 2-week studies, except rotated weekly in chambers	Same as 2-week studies
<b>Cageboard</b> Untreated paper cage pan liner (Techboard, Shepherd Specialty Papers, Kalamazoo, MI), changed daily	Same as 2-week studies	Same as 3-month studies
<b>Chamber Air Supply Filters</b> Single HEPA (open stock), charcoal (RSE, Inc., New Baltimore, MI), Purafil (Environmental Systems, Lynnwood, WA), all new at study start	Same as 2-week studies	Same as 2-week studies, except HEPA filter changed annually
<b>Chambers</b> Stainless steel chambers, excreta pan at each occupied level (Lab Products, Inc., Seaford, DE) chambers changed weekly, excreta pans changed daily	Same as 2-week studies	Same as 2-week studies
<b>Chamber Environment</b> Temperature: 75° ± 3° F Relative humidity: 55% ± 15% Room fluorescent light: 12 hours/day Chamber air changes: 15 ± 2/hour	Same as 2-week studies	Same as 2-week studies
<b>Exposure Concentrations</b> 0, 25, 50, 100, 200, or 400 ppm in air	0, 6.25, 12.5, 25, 50, or 100 (except male mice) ppm in air	Rats: 0, 25, 50, or 100 ppm in air Mice: 0, 6.25, 12.5, or 25 ppm in air



**TABLE 1**  
**Experimental Design and Materials and Methods in the Inhalation Studies of Vinylidene Chloride**

2-Week Studies	3-Month Studies	2-Year Studies
<p><b>Type and Frequency of Observation</b>            Observed twice daily; animals were weighed on days 1, 6, 13, and at the end of studies; clinical findings were recorded daily before and after exposure and at the end of the studies.</p>	<p>Observed twice daily; core study animals were weighed initially, day 9 (female rats) or 10, weekly thereafter, and at the end of the studies. Clinical findings were recorded on day 9 (female rats) or day 10, weekly thereafter, and at the end of the studies.</p>	<p>Observed twice daily. Animals were weighed initially, weekly for the first 13 weeks, every 4 weeks through week 93, every 2 weeks thereafter, and at the end of the studies. Clinical findings were recorded every 4 weeks through week 93, then every 2 weeks, and at the end of the studies.</p>
<p><b>Method of Kill</b>            Carbon dioxide asphyxiation</p>	<p>Same as 2-week studies</p>	<p>Same as 2-week studies</p>
<p><b>Necropsy</b>            Necropsies were performed on all animals. Organs weighed were heart, right kidney, liver, lung, right testis, and thymus.</p>	<p>Necropsies were performed on all core study animals. Organs weighed were heart, right kidney, liver, lung, right testis, and thymus.</p>	<p>Necropsies were performed on all animals.</p>
<p><b>Clinical Pathology</b>            None</p>	<p>Blood was collected from the retroorbital sinus of clinical pathology rats on days 3 and 23 and from core study animals at the end of the studies for hematology and clinical chemistry (rats only).  <b>Hematology:</b> hematocrit; hemoglobin concentration; erythrocyte, reticulocyte, and platelet counts; erythrocyte and platelet morphology; mean cell volume; mean cell hemoglobin; mean cell hemoglobin concentration; and leukocyte count and differentials  <b>Clinical chemistry:</b> urea nitrogen, creatinine, total protein, albumin, alanine aminotransferase, alkaline phosphatase, creatine kinase, sorbitol dehydrogenase, and bile acids</p>	<p>None</p>
<p><b>Histopathology</b>            Histopathology was performed on 0, 100, 200, and 400 ppm rats and 0, 50, 100, 200, and 400 ppm mice. In addition to gross lesions and tissue masses, the eyes, kidney (except 50 ppm female mice), liver, lung, and nose were examined to a no-effect-level.</p>	<p>Complete histopathology was performed on 0 and 100 ppm core study rats, 0 and 50 ppm male mice and 0 and 100 ppm female mice. In addition to gross lesions and tissue masses, the following tissues were examined to a no-effect-level: adrenal gland, bone with marrow, brain, clitoral gland, esophagus, eyes, gallbladder (mice), Harderian gland, heart, large intestine (cecum, colon, rectum), small intestine (duodenum, jejunum, ileum), kidney, larynx, liver, lung, lymph nodes (mandibular, mesenteric, bronchial, and mediastinal), mammary gland, nose, ovary, pancreas, parathyroid gland, pituitary gland, preputial gland, prostate gland, salivary gland, skin, spleen, stomach (forestomach and glandular), testis with epididymis and seminal vesicle, thymus, thyroid gland, trachea, urinary bladder, and uterus.</p>	<p>Complete histopathology was performed on all rats and mice. In addition to gross lesions and tissue masses, the following tissues were examined: adrenal gland, bone with marrow, brain, clitoral gland, esophagus, eyes, gallbladder (mice), Harderian gland, heart, large intestine (cecum, colon, rectum), small intestine (duodenum, jejunum, ileum), kidney, larynx, liver, lung, lymph nodes (mandibular, mesenteric, bronchial, and mediastinal), mammary gland, nose, ovary, pancreas, parathyroid gland, pituitary gland, preputial gland, prostate gland, salivary gland, skin, spleen, stomach (forestomach and glandular), testis with epididymis and seminal vesicle, thymus, thyroid gland, trachea, urinary bladder, and uterus.</p>

**TABLE 1**  
**Experimental Design and Materials and Methods in the Inhalation Studies of Vinylidene Chloride**

2-Week Studies	3-Month Studies	2-Year Studies
<b>Sperm Motility            and Vaginal Cytology</b> None	At the end of the studies, spermatid and sperm samples were collected from male animals in the 0, 12.5 (mice), 25, 50, and 100 (rats) ppm groups. The following parameters were evaluated: spermatid heads per testis and per gram testis, sperm motility, and sperm per cauda epididymis and per gram cauda epididymis. The left cauda, left epididymis, and left testis were weighed. Vaginal samples were collected for up to 12 consecutive days prior to the end of the studies from females exposed to 0, 12.5 (mice), 25, 50 or 100 (rats) ppm.	None

## STATISTICAL METHODS

### Survival Analyses

The probability of survival was estimated by the product-limit procedure of Kaplan and Meier (1958) and is presented in the form of graphs. Animals found dead of other than natural causes were censored; animals dying from natural causes were not censored. Statistical analyses for possible dose-related effects on survival used Cox's (1972) method for testing two groups for equality and Tarone's (1975) life table test to identify dose-related trends. All reported P values for the survival analyses are two sided.

### Calculation of Incidence

The incidences of neoplasms or nonneoplastic lesions are presented in Tables A1, A4, B1, B4, C1, C4, D1, and D4 as the numbers of animals bearing such lesions at a specific anatomic site and the numbers of animals with that site examined microscopically. For calculation of statistical significance, the incidences of most neoplasms (Tables A2, B2, C2, and D2) and all nonneoplastic lesions are given as the numbers of animals affected at each site examined microscopically. However, when macroscopic examination was required to detect neoplasms in certain tissues (e.g., mesentery, pleura, peripheral nerve, skeletal muscle, tongue, tooth, and Zymbal's gland) before microscopic evaluation, the denominators consist of the number of animals that had a gross abnormality. When neoplasms had multiple potential sites of occurrence (e.g., leukemia or lymphoma), the denominators consist of the number of

animals on which a necropsy was performed. Tables A2, B2, C2, and D2 also give the survival-adjusted neoplasm rate for each group and each site-specific neoplasm. This survival-adjusted rate (based on the Poly-3 method described below) accounts for differential mortality by assigning a reduced risk of neoplasm, proportional to the third power of the fraction of time on study, only to site-specific, lesion-free animals that do not reach terminal kill.

### **Analysis of Neoplasm and Nonneoplastic Lesion Incidences**

The Poly-k test (Bailer and Portier, 1988; Portier and Bailer, 1989; Piegorsch and Bailer, 1997) was used to assess neoplasm and nonneoplastic lesion prevalence. This test is a survival-adjusted quantal-response procedure that modifies the Cochran-Armitage linear trend test to take survival differences into account. More specifically, this method modifies the denominator in the quantal estimate of lesion incidence to approximate more closely the total number of animal years at risk. For analysis of a given site, each animal is assigned a risk weight. This value is one if the animal had a lesion at that site or if it survived until terminal kill; if the animal died prior to terminal kill and did not have a lesion at that site, its risk weight is the fraction of the entire study time that it survived, raised to the  $k$ th power.

This method yields a lesion prevalence rate that depends only upon the choice of a shape parameter for a Weibull hazard function describing cumulative lesion incidence over time (Bailer and Portier, 1988). Unless otherwise specified, a value of  $k=3$  was used in the analysis of site-specific lesions. This value was recommended by Bailer and Portier (1988) following an evaluation of neoplasm onset time distributions for a variety of site-specific neoplasms in control F344/N rats and B6C3F1/N mice (Portier *et al.*, 1986). Bailer and Portier (1988) showed that the Poly-3 test gave valid results if the true value of  $k$  was anywhere in the range from 1 to 5. A further advantage of the Poly-3 method is that it does not require lesion lethality assumptions. Variation introduced by the use of risk weights, which reflect differential mortality, was accommodated by adjusting the variance of the Poly-3 statistic as recommended by Bieler and Williams (1993).

Tests of significance included pairwise comparisons of each dosed group with controls and a test for an overall dose-related trend. Continuity-corrected Poly-3 tests were used in the analysis of lesion incidence, and reported

P values are one sided. The significance of lower incidences or decreasing trends in lesions is represented as 1–P with the letter N added (e.g., P=0.99 is presented as P=0.01N).

### **Analysis of Continuous Variables**

Two approaches were employed to assess the significance of pairwise comparisons between dosed and control groups in the analysis of continuous variables. Organ and body weight data, which historically have approximately normal distributions, were analyzed with the parametric multiple comparison procedures of Dunnett (1955) and Williams (1971, 1972). Hematology, clinical chemistry, spermatid, and epididymal spermatozoal data, which have typically skewed distributions, were analyzed using the nonparametric multiple comparison methods of Shirley (1977) (as modified by Williams, 1986) and Dunn (1964). Jonckheere's test (Jonckheere, 1954) was used to assess the significance of the dose-related trends and to determine whether a trend-sensitive test (Williams' or Shirley's test) was more appropriate for pairwise comparisons than a test that does not assume a monotonic dose-related trend (Dunnett's or Dunn's test). Prior to statistical analysis, extreme values identified by the outlier test of Dixon and Massey (1957) were examined by NTP personnel, and implausible values were eliminated from the analysis. Proportions of regular cycling females in each dosed group were compared to the control group using the Fisher exact test (Gart *et al.*, 1979). Tests for extended periods of estrus, diestrus, metestrus, and proestrus, as well as skipped estrus and skipped diestrus, were constructed based on a Markov chain model proposed by Girard and Sager (1987). For each dose group, a transition probability matrix was estimated for transitions among the proestrus, estrus, metestrus, and diestrus stages, with provision for extended stays within each stage as well as for skipping estrus or diestrus within a cycle. Equality of transition matrices among dose groups and between the control group and each dosed group was tested using chi-square statistics.

### **Historical Control Data**

The concurrent control group represents the most valid comparison to the treated groups and is the only control group analyzed statistically in NTP bioassays. However, historical control data are often helpful in interpreting potential treatment-related effects, particularly for uncommon or rare neoplasm types. For meaningful comparisons, the conditions for studies in the historical database must be generally similar. One significant factor affecting the background incidence of neoplasms at a variety of sites is diet. In 1995, the NTP incorporated a new diet

(NTP-2000) that contains less protein and more fiber and fat than the NIH-07 diet previously used in toxicity and carcinogenicity studies (Rao, 1996, 1997). The NTP historical database contains all studies that use the NTP-2000 diet with histopathology findings completed within the most recent 5-year period. A second potential source of variability is route of administration. In general, the historical database for a given study will include studies using the same route of administration, and the overall incidences of neoplasms for all routes of administration are included for comparison, including the present study.

## QUALITY ASSURANCE METHODS

The 2-week, 3-month, and 2-year studies were conducted in compliance with Food and Drug Administration Good Laboratory Practice Regulations (21 CFR, Part 58). In addition, as records from the 3-month and 2-year studies were submitted to the NTP Archives, these studies were audited retrospectively by an independent quality assessment contractor. Separate audits covered completeness and accuracy of the pathology data, pathology specimens, final pathology tables, and a draft of this NTP Technical Report. Audit procedures and findings are presented in the reports and are on file at NIEHS. The audit findings were reviewed and assessed by NTP staff, and all comments were resolved or otherwise addressed during the preparation of this Technical Report.

## GENETIC TOXICOLOGY

The genetic toxicity of vinylidene chloride was assessed by testing the ability of the chemical to induce mutations in various strains of *Salmonella typhimurium*, mutations in L5178Y mouse lymphoma cells, sex-linked recessive lethal mutations in *Drosophila melanogaster*, and increases in the frequency of micronucleated erythrocytes in mouse peripheral blood. Micronuclei (literally “small nuclei” or Howell-Jolly bodies) are biomarkers of induced structural or numerical chromosomal alterations and are formed when acentric fragments or whole chromosomes fail to incorporate into either of two daughter nuclei during cell division (Schmid, 1975; Heddle *et al.*, 1983). The protocols for these studies and the results are given in Appendix E.

The genetic toxicity studies have evolved from an earlier effort by the NTP to develop a comprehensive database permitting a critical anticipation of a chemical’s carcinogenicity in experimental animals based on numerous

considerations, including the molecular structure of the chemical and its observed effects in short-term *in vitro* and *in vivo* genetic toxicity tests (structure-activity relationships). The short-term tests were originally developed to clarify proposed mechanisms of chemical-induced DNA damage based on the relationship between electrophilicity and mutagenicity (Miller and Miller, 1977) and the somatic mutation theory of cancer (Straus, 1981; Crawford, 1985). However, it should be noted that not all cancers arise through genotoxic mechanisms.

DNA reactivity combined with *Salmonella* mutagenicity is highly correlated with induction of carcinogenicity in multiple species/sexes of rodents and at multiple tissue sites (Ashby and Tennant, 1991). A positive response in the *Salmonella* test was shown to be the most predictive *in vitro* indicator for rodent carcinogenicity (89% of the *Salmonella* mutagens are rodent carcinogens) (Tennant *et al.*, 1987; Zeiger *et al.*, 1990). Additionally, no battery of tests that included the *Salmonella* test improved the predictivity of the *Salmonella* test alone. However, these other tests can provide useful information on the types of DNA and chromosomal damage induced by the chemical under investigation.

The predictivity for carcinogenicity of a positive response in acute *in vivo* bone marrow chromosome aberration or micronucleus tests appears to be less than that in the *Salmonella* test (Shelby *et al.*, 1993; Shelby and Witt, 1995). However, clearly positive results in long-term peripheral blood micronucleus tests have high predictivity for rodent carcinogenicity; a weak response in one sex only or negative results in both sexes in this assay do not correlate well with either negative or positive results in rodent carcinogenicity studies (Witt *et al.*, 2000). Because of the theoretical and observed associations between induced genetic damage and adverse effects in somatic and germ cells, the determination of *in vivo* genetic effects is important to the overall understanding of the risks associated with exposure to a particular chemical.

## RESULTS

### RATS

#### 2-WEEK STUDY

All male and nine of 10 female rats in the 200 and 400 ppm groups were found dead by day 2; one 400 ppm female was found dead on day 4 (Table 2). All other rats survived the entire study except one 25 ppm male removed from the study due to chylothorax (nonexposure-related condition). The mean body weight gain of 100 ppm females was significantly less than that of the chamber controls. Final mean body weights of male and female rats exposed to 100 ppm were 3% and 6% less, respectively, than those of the chamber control groups. All females and nine of 10 males exposed to 200 or 400 ppm became lethargic, while all females and four of five males exposed to 400 ppm developed ataxia.

Absolute and relative kidney weights of all surviving groups of exposed males and females were significantly greater than those of the chamber controls (Table G1). In males, relative lung weights were increased at 100 ppm compared to controls, and an increasing trend was observed in absolute and relative lung weights.

**TABLE 2**  
**Survival and Body Weights of Rats in the 2-Week Inhalation Study of Vinylidene Chloride<sup>a</sup>**

Concentration (ppm)	Survival <sup>b</sup>	Initial Body Weight (g)	Final Body Weight (g)	Change in Body Weight (g)	Final Weight Relative to Controls (%)
<b>Male</b>					
0	5/5	93 ± 2	158 ± 2	66 ± 3	
25	4/5 <sup>c</sup>	91 ± 1	150 ± 3	60 ± 4	95
50	5/5	92 ± 3	159 ± 5	67 ± 3	100
100	5/5	93 ± 1	154 ± 2	62 ± 2	97
200	0/5 <sup>d</sup>	92 ± 2	—	—	
400	0/5 <sup>e</sup>	91 ± 2	—	—	
<b>Female</b>					
0	5/5	84 ± 1	124 ± 2	40 ± 1	
25	5/5	84 ± 1	125 ± 3	40 ± 3	101
50	5/5	84 ± 2	122 ± 1	38 ± 2	98
100	5/5	83 ± 2	117 ± 3	34 ± 1*	94
200	0/5 <sup>d</sup>	83 ± 1	—	—	
400	0/5 <sup>f</sup>	84 ± 1	—	—	

\* Significantly different ( $P \leq 0.05$ ) from the chamber control group by Williams' test

<sup>a</sup> Weights and weight changes are given as mean ± standard error. Subsequent calculations are based on animals surviving to the end of the study.

<sup>b</sup> Number of animals surviving at 16 days/number initially in group

<sup>c</sup> Day of death: 10

<sup>d</sup> Day of deaths: 2

<sup>e</sup> Days of deaths: 1, 2, 2, 2, 2

<sup>f</sup> Days of deaths: 2, 2, 2, 2, 4

In the liver, centrilobular necrosis was associated with early deaths in male and female rats exposed to 200 or 400 ppm vinylidene chloride and was characterized as partial or complete disintegration of hepatocytes within the central areas of hepatic lobules, sparing only the periportal areas (Table 3). Necrotic hepatocytes were replaced with hemorrhage and necrotic debris, and the remaining viable hepatocytes had pale or vacuolated cytoplasm and margination of nuclear chromatin. Mild centrilobular necrosis was also observed in one 25 ppm male rat, and it was characterized by shrunken, eosinophilic hepatocytes with complete or partial loss of nuclear and cell membranes and karyorrhexis. Centrilobular cytoplasmic alteration of hepatocytes occurred in all exposed male and female rats that survived to terminal kill. Hepatocytic centrilobular cytoplasmic alteration was characterized by decreased cytoplasmic staining, perinuclear halos, and flocculent cytoplasm. Mean severity of this alteration was slightly higher in males. Centrilobular cytoplasmic alteration likely represents a form of hepatocellular degeneration,



**TABLE 3**  
**Incidences of Selected Nonneoplastic Lesions in Rats in the 2-Week Inhalation Study of Vinylidene Chloride**

	Chamber Control	25 ppm	50 ppm	100 ppm	200 ppm	400 ppm
<b>Male</b>						
Liver <sup>a</sup>	5	5	5	5	5	5
Centrilobular, Necrosis <sup>b</sup>	0	1 (2.0) <sup>c</sup>	0	0	5** (4.0)	5** (4.0)
Hepatocyte, Centrilobular, Cytoplasmic Alteration	0	4* (2.8)	5** (3.0)	5** (3.0)	0	0
Kidney	5	0	0	5	5	5
Papilla, Renal Tubule, Casts	0			0	5** (3.2)	4* (2.5)
<b>Female</b>						
Liver	5	5	5	5	5	5
Centrilobular, Necrosis	0	0	0	0	5** (4.0)	5** (4.0)
Hepatocyte, Centrilobular, Cytoplasmic Alteration	0	5** (2.4)	5** (3.0)	5** (2.6)	0	0
Kidney	5	0	0	5	5	5
Papilla, Renal Tubule, Casts	0			0	5** (3.0)	5** (3.2)

\* Significantly different ( $P \leq 0.05$ ) from the chamber control group by the Fisher exact test

\*\*  $P \leq 0.01$

<sup>a</sup> Number of animals with tissue examined microscopically

<sup>b</sup> Number of animals with lesion

<sup>c</sup> Average severity grade of lesions in affected animals: 1=minimal, 2=mild, 3=moderate, 4=marked

because rats exposed to 200 and 400 ppm did not have cytoplasmic alteration, but rather centrilobular necrosis, consistent with a more severe stage of hepatocellular damage.

Renal tubule casts occurred in the renal papillae of 200 and 400 ppm rats, characterized by the presence of variable amounts of finely granular, brightly eosinophilic material in dilated tubule lumens of the renal papillae (Table 3).

*Exposure Concentration Selection Rationale:* Based on decreased survival of males and females exposed to 200 or 400 ppm in the 2-week study, vinylidene chloride exposure concentrations selected for the 3-month inhalation study in rats were 6.25, 12.5, 25, 50, and 100 ppm. Doses were also partially based on the lack of hepatocellular necrosis in the 25, 50, and 100 ppm groups. Cytoplasmic alteration was not considered to be dose limiting.

### 3-MONTH STUDY

All rats survived until the end of the study (Table 4). Final mean body weights and body weight gains of exposed groups were similar to those of the chamber control groups (Table 4 and Figure 2). No exposure-related clinical findings or gross lesions were observed.

**TABLE 4**  
**Survival and Body Weights of Rats in the 3-Month Inhalation Study of Vinylidene Chloride<sup>a</sup>**

Concentration (ppm)	Survival <sup>b</sup>	Initial Body Weight (g)	Final Body Weight (g)	Change in Body Weight (g)	Final Weight Relative to Controls (%)
<b>Male</b>					
0	10/10	111 ± 2	326 ± 7	216 ± 6	
6.25	10/10	110 ± 2	332 ± 6	222 ± 6	102
12.5	10/10	111 ± 2	337 ± 5	226 ± 5	103
25	10/10	110 ± 2	319 ± 6	209 ± 6	98
50	10/10	111 ± 1	340 ± 6	230 ± 6	104
100	10/10	111 ± 2	322 ± 5	212 ± 6	99
<b>Female</b>					
0	10/10	96 ± 2	203 ± 3	108 ± 2	
6.25	10/10	96 ± 2	205 ± 6	109 ± 5	101
12.5	10/10	95 ± 2	206 ± 4	111 ± 3	101
25	10/10	95 ± 2	201 ± 4	106 ± 3	99
50	10/10	95 ± 2	205 ± 4	110 ± 3	101
100	10/10	96 ± 1	195 ± 2	100 ± 2	96

<sup>a</sup> Weights and weight changes are given as mean ± standard error.

<sup>b</sup> Number of animals surviving at 14 weeks/number initially in group

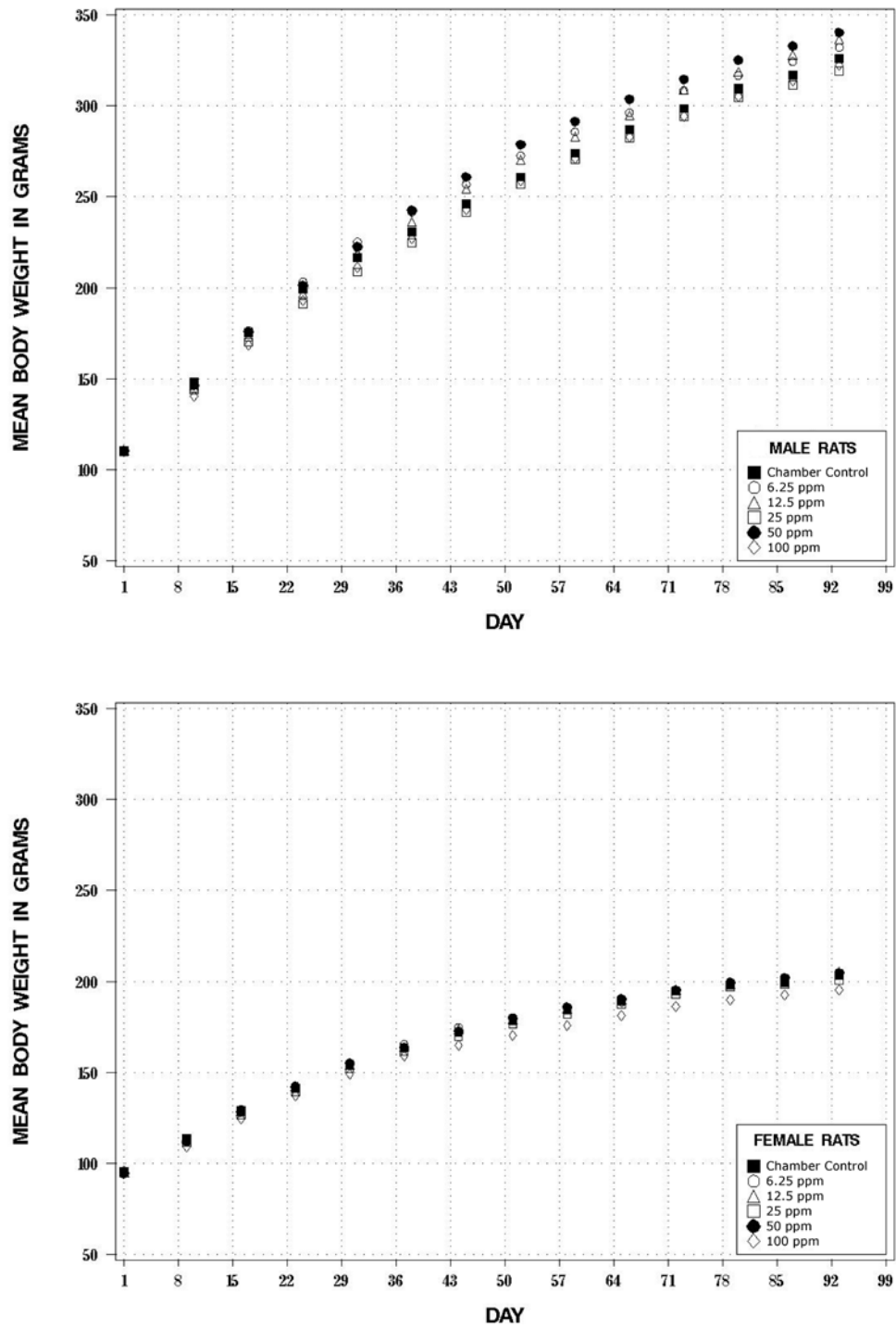


FIGURE 2  
Growth Curves for Rats Exposed to Vinylidene Chloride by Inhalation for 3 Months

The hematology and clinical chemistry data for rats are presented in Table F1. Slight increases ( $\leq 6\%$ ) in hemoglobin concentrations and red blood cell (erythrocyte) counts were observed in 100 ppm male and female rats on day 3. In addition, on day 3 the hematocrit was also slightly increased in 100 ppm males. These changes ameliorated by day 23 and were consistent with a transient hemoconcentration associated with mild dehydration as the rats acclimated to exposure. No other hematological changes were considered toxicologically or biologically relevant.

Exposure concentration-related minimal to mild ( $\leq 10\%$ ) increases were observed in total protein and globulin concentrations on days 3 and 23 in both male and female rats in various exposed groups, but most consistently at 100 ppm. In addition, albumin was minimally increased ( $\leq 5\%$ ) in 100 ppm males and 25 ppm or greater female rats on day 23. Urea nitrogen concentrations were minimally increased in 50 and 100 ppm male and female rats on day 3, and 50 and 100 ppm males and 6.25 ppm or greater females on day 23. Similar to the observed changes in the erythron, the total protein, albumin, globulin, and urea nitrogen concentrations returned to chamber control levels by week 14 and were consistent with mild dehydration.

Increased alkaline phosphatase activities were observed in the 50 and 100 ppm groups on days 3 and 23 in male rats and on day 23 in female rats. While increased alkaline phosphatase activity is considered an indicator of cholestasis, the increases were of minimal severity and transient, and bile acid concentrations, another marker for cholestasis, were unchanged or decreased, suggesting that these changes represent a transient alteration in hepatic metabolism rather than cholestasis.

Sorbitol dehydrogenase (SDH) activities were increased in 100 ppm females on day 3 and in 100 ppm males and 50 and 100 ppm females on day 23. In addition, alanine aminotransferase (ALT) activities were increased on day 3 in 50 and 100 ppm male rats and day 23 in 100 ppm male rats. Both SDH and ALT are considered markers of hepatocellular injury. These increases were transient, not being observed at week 14, and minimal histopathologic changes were observed in the liver at study termination; therefore, these changes are consistent with mild transient hepatocellular injury.

Relative kidney weights of 6.25, 12.5, and 100 ppm males and absolute and relative kidney weights of 12.5 ppm or greater females were significantly greater than those of the chamber controls (Table G2).

Male rats exposed to 100 ppm exhibited significantly lower sperm motility (approximately 5% less than chamber controls) (Table H1). Rats in this exposed group also exhibited lower spermatid/g testis and total spermatid/testis values (15% and 16%, respectively, compared to chamber controls). At necropsy, rats did not display any histopathologic change in the contralateral organ; however, fixation quality of the rat testes was poor. There were no vinylidene chloride-related changes in estrous cyclicity in female rats (Table H2). Therefore, vinylidene chloride exhibits the potential to be a reproductive toxicant in male rats but not in female rats.

Microscopic lesions of the nose were noted in both sexes of rats (Table 5). A combination of lesions in the nasal epithelium composed of olfactory epithelium atrophy, mineralization, and necrosis and turbinate atrophy was observed with generally increasing severity with increasing exposure to vinylidene chloride. A no-effect level was not observed, although turbinate atrophy was not seen in rats exposed to 6.25 ppm, and most of the lesions were minimal in rats exposed to 12.5 ppm or less. Atrophy of the olfactory epithelium was characterized by a decrease in the number of olfactory epithelial cells lining the turbinates, usually in the dorsal meatus of Level III, and by replacement with a single layer of respiratory-type epithelium (metaplasia). This lesion was often associated with a corresponding decrease in nerve fibers and glands in the underlying lamina propria. Mineralization of the olfactory epithelium was characterized by linear to irregular, oval to elongate laminated deposits of greyish-blue material in the basement membrane, often underlying an atrophic epithelium or disrupting the epithelium, and most often affecting the lateral walls and turbinates. Olfactory epithelial necrosis occurred at the dorsal meatus, dorsal septum, and all regions of ethmoturbinates in Level III of the nose. Necrosis of the olfactory epithelium was characterized by areas of nuclear pyknosis of the epithelium, fragmentation, and hypereosinophilia, and in some areas, full-thickness sloughing of the epithelium and cell debris into the nasal passages at Level III. Necrosis was not associated with inflammation. Turbinate atrophy was characterized by thinning and blunting of primarily the ethmoid turbinates of Level III, often with bony remodeling.

**TABLE 5**  
**Incidences of Selected Nonneoplastic Lesions in Rats in the 3-Month Inhalation Study**  
**of Vinylidene Chloride**

	Chamber Control	6.25 ppm	12.5 ppm	25 ppm	50 ppm	100 ppm
<b>Male</b>						
Nose <sup>a</sup>	10	10	10	10	10	10
Olfactory Epithelium, Atrophy <sup>b</sup>	0	4* (1.0) <sup>c</sup>	10** (1.0)	10** (1.7)	10** (2.2)	10** (2.7)
Olfactory Epithelium, Mineralization	0	10** (1.3)	10** (2.0)	10** (2.9)	10** (3.0)	10** (2.6)
Olfactory Epithelium, Necrosis	0	2 (1.0)	6** (1.0)	9** (1.0)	7** (1.7)	10** (1.6)
Turbinates, Atrophy	0	0	10** (1.0)	10** (2.0)	10** (2.2)	10** (3.0)
Liver	10	10	10	10	10	10
Centrilobular, Cytoplasmic Alteration	1 (1.0)	1 (1.0)	6* (1.7)	10** (1.8)	10** (2.0)	10** (1.9)
<b>Female</b>						
Nose	10	10	10	10	10	10
Olfactory Epithelium, Atrophy	0	2 (1.0)	10** (1.0)	10** (1.3)	10** (1.7)	10** (2.4)
Olfactory Epithelium, Mineralization	0	5* (1.0)	9** (1.3)	10** (1.9)	10** (2.1)	10** (2.3)
Olfactory Epithelium, Necrosis	0	1 (1.0)	3 (1.3)	6** (1.5)	10** (2.2)	10** (1.6)
Turbinates, Atrophy	0	0	10** (1.0)	10** (2.0)	10** (2.2)	10** (3.0)
Liver	10	10	10	10	10	10
Vacuolization, Cytoplasmic	0	0	0	0	10** (1.1)	10** (1.0)

\* Significantly different (P<0.05) from the chamber control group by the Fisher exact test

\*\* P<0.01

<sup>a</sup> Number of animals with tissue examined microscopically

<sup>b</sup> Number of animals with lesion

<sup>c</sup> Average severity grade of lesions in affected animals: 1=minimal, 2=mild, 3=moderate, 4=marked

In the liver of male rats, centrilobular cytoplasmic alteration was significantly increased at 12.5 ppm or greater. In females, cytoplasmic vacuolization was observed at 50 and 100 ppm (Table 5). Centrilobular cytoplasmic alteration was characterized by a decrease in cytoplasmic eosinophilia of hepatocytes located in centrilobular areas; this lesion was not observed in female rats. Cytoplasmic vacuolization was characterized by single to multiple clear, well-circumscribed, round, 1 to 15 µm diameter vacuoles in the cytoplasm of hepatocytes.

Decreased incidences of nephropathy were observed in male rats exposed to vinylidene chloride (6/10, 3/10, 4/10, 4/10, 3/10, 1/10). All incidences of nephropathy in the chamber controls were graded as minimal, and the lesion

was characterized by single to few clusters of regenerative tubules with minimal thickening of the basement membrane. The higher exposure concentration groups had histologically normal kidneys. This lesion is a common background finding in the F344/N rat and was unrelated to vinylidene chloride exposure. The decreasing incidence of nephropathy in exposed animals is of uncertain biologic significance.

*Exposure Concentration Selection Rationale:* In the 3-month studies, minimal changes in clinical chemistry parameters were considered reflective of possible mild dehydration. While increased kidney weights were observed in males and females, there were no corresponding histopathologic changes in the kidney. The nose and the liver were target organs in both sexes. However, the observed lesions were not considered preclusive for chronic administration at these exposures. Exposure concentrations greater than 100 ppm were not considered due to increased mortality observed at greater than 100 ppm in the 2-week study. Based on the overall minimal chemical-related toxicity in the 3-month study, vinylidene chloride exposure concentrations selected for the 2-year inhalation study in rats were 25, 50, and 100 ppm.

## 2-YEAR STUDY

### Survival

Estimates of 2-year survival probabilities for male and female rats are shown in Table 6 and in the Kaplan-Meier survival curves (Figure 3). Survival of exposed groups of males was similar to that of the chamber control group. Survival of 100 ppm females was significantly less than that of the chamber controls.

**TABLE 6**  
**Survival of Rats in the 2-Year Inhalation Study of Vinylidene Chloride**

	Chamber Control	25 ppm	50 ppm	100 ppm
<b>Male</b>				
Animals initially in study	50	50	50	50
Moribund	21	15	23	27
Natural deaths	4	8	5	4
Animals surviving to study termination	25	27	22	19
Percent probability of survival at end of study <sup>a</sup>	50	54	44	38
Mean survival (days) <sup>b</sup>	680	662	650	646
Survival analysis <sup>c</sup>	P=0.121	P=1.000	P=0.372	P=0.207
<b>Female</b>				
Animals initially in study	50	50	50	50
Moribund	19	22	18	28
Natural deaths	1	2	2	3
Animals surviving to study termination	30	26	30 <sup>d</sup>	19
Percent probability of survival at end of study	60	52	58	38
Mean survival (days)	705	681	678	675
Survival analysis	P=0.046	P=0.337	P=0.709	P=0.029

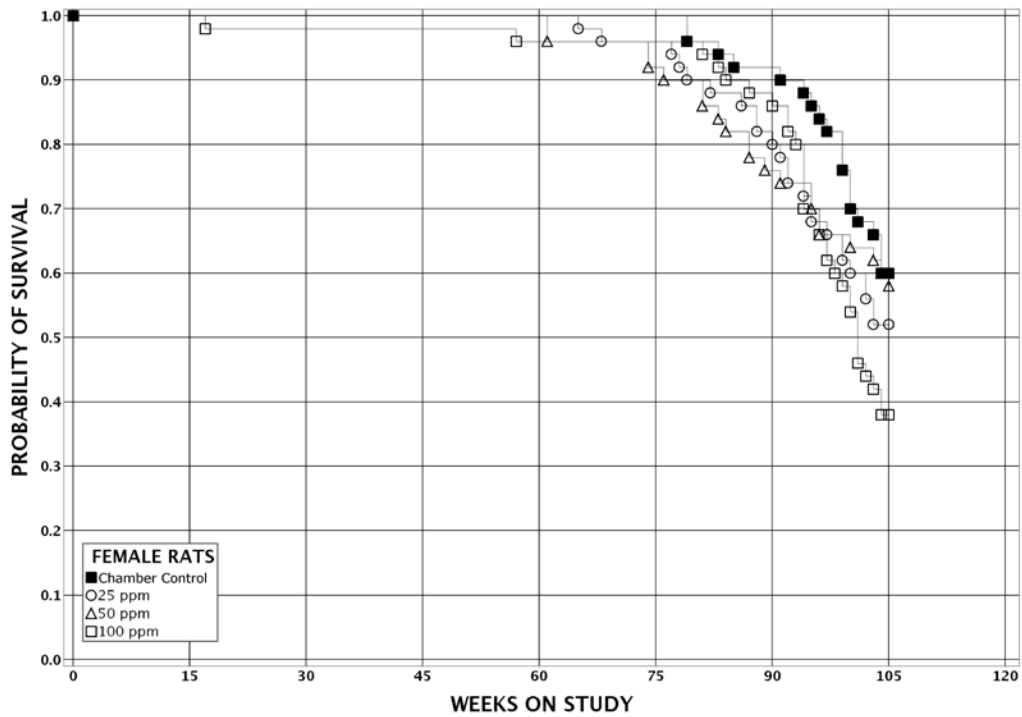
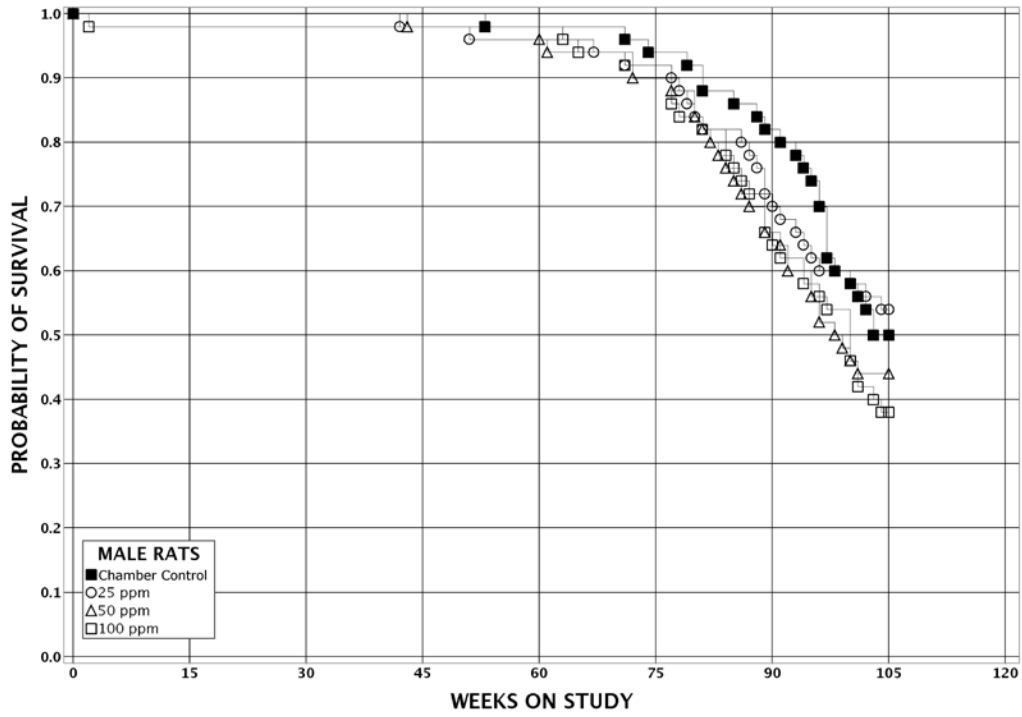
<sup>a</sup> Kaplan-Meier determinations

<sup>b</sup> Mean of all deaths (uncensored, censored, and terminal kill)

<sup>c</sup> The result of the life table trend test (Tarone, 1975) is in the chamber control column, and the results of the life table pairwise comparisons (Cox, 1972) with the chamber controls are in the exposed group columns.

<sup>d</sup> Includes one animal that died during the last week of the study





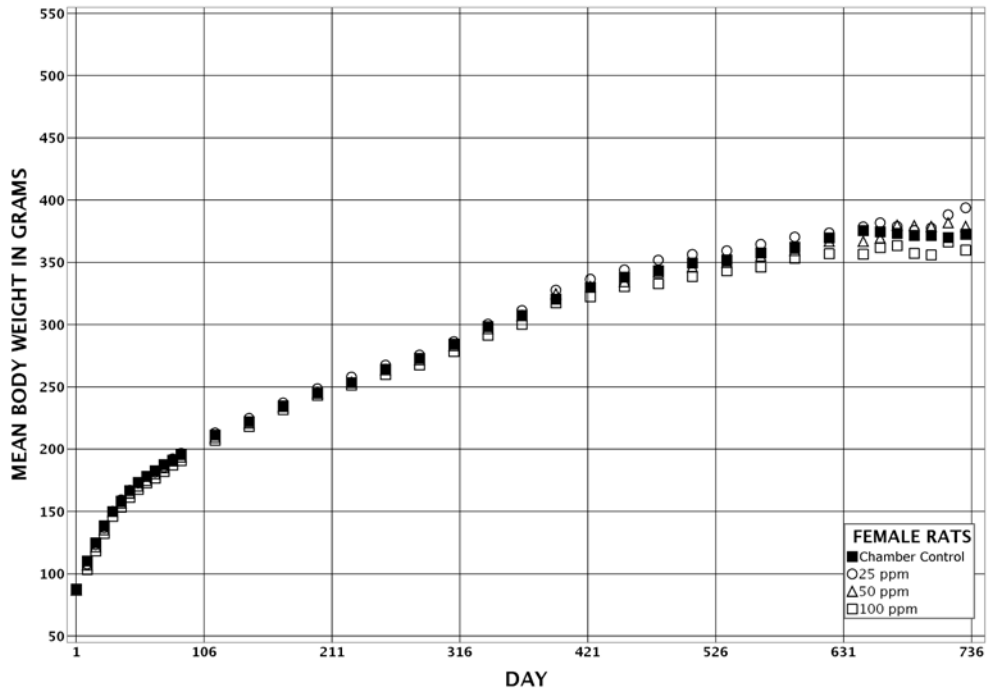
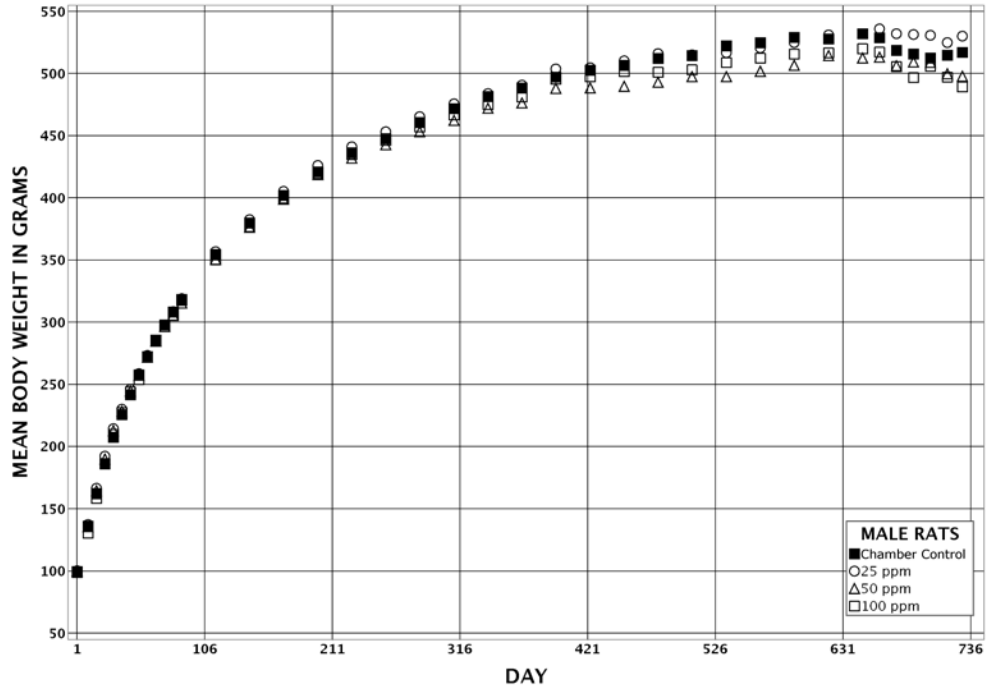
**FIGURE 3**  
**Kaplan-Meier Survival Curves for Rats**  
**Exposed to Vinylidene Chloride by Inhalation for 2 Years**

### **Body Weights and Clinical Findings**

Mean body weights of exposed groups of male and female rats were similar to those of the chamber control groups throughout the study (Figure 4 and Tables 7 and 8). No clinical findings related to vinylidene chloride exposure were observed in male rats; thinness was observed in approximately half of the 100 ppm females.

### **Gross Findings**

Fluid in the abdomen and multiple nodules on the peritoneum, particularly on the testicular tunics and epididymides, were grossly observed. These findings were associated with exposure to vinylidene chloride and resulted from the occurrence of mesothelioma.



**FIGURE 4**  
**Growth Curves for Rats Exposed to Vinylidene Chloride by Inhalation for 2 Years**

**TABLE 7**  
**Mean Body Weights and Survival of Male Rats in the 2-Year Inhalation Study of Vinylidene Chloride**

Day	Chamber Control		25 ppm			50 ppm			100 ppm		
	Av. Wt. (g)	No. of Survivors	Av. Wt. (g)	Wt. (% of Controls)	No. of Survivors	Av. Wt. (g)	Wt. (% of Controls)	No. of Survivors	Av. Wt. (g)	Wt. (% of Controls)	No. of Survivors
1	100	50	100	101	50	100	100	50	99	99	50
10	136	50	137	101	50	136	100	50	131	96	49
17	162	50	167	103	50	164	101	50	159	98	49
24	186	50	192	103	50	190	102	50	186	100	49
31	208	50	214	103	50	213	103	50	210	101	49
38	226	50	230	102	50	228	101	50	227	101	49
45	242	50	246	102	50	245	101	50	244	101	49
52	258	50	259	100	50	258	100	50	254	99	49
59	272	50	273	100	50	272	100	50	272	100	49
66	286	50	286	100	50	285	100	50	285	100	49
73	298	50	298	100	50	296	100	50	297	100	49
80	308	50	309	100	50	306	99	50	305	99	49
87	318	50	319	100	50	315	99	50	318	100	49
115	354	50	357	101	50	351	99	50	350	99	49
143	380	50	383	101	50	376	99	50	377	99	49
171	402	50	405	101	50	399	99	50	400	100	49
199	421	50	426	101	50	419	99	50	420	100	49
227	436	50	441	101	50	432	99	50	435	100	49
255	448	50	453	101	50	443	99	50	446	100	49
283	461	50	465	101	50	453	98	50	457	99	49
311	472	50	476	101	49	463	98	49	467	99	49
339	482	50	484	101	49	472	98	49	475	99	49
367	488	49	491	101	48	476	98	49	481	99	49
395	497	49	504	101	48	488	98	49	496	100	49
423	503	49	505	100	48	489	97	47	498	99	49
451	507	49	510	101	48	490	97	47	502	99	47
479	512	49	516	101	47	493	96	47	501	98	47
507	515	48	515	100	46	498	97	45	503	98	46
535	522	47	517	99	45	498	95	44	509	98	43
563	525	45	521	99	41	502	96	41	513	98	41
591	529	43	525	99	41	507	96	37	516	97	39
619	528	42	531	101	36	514	97	33	517	98	33
647	532	39	532	100	34	513	96	30	520	98	31
661	529	37	536	101	31	513	97	28	518	98	29
675	519	34	532	103	30	506	98	26	506	98	28
689	516	30	532	103	30	509	99	24	497	96	27
703	512	29	531	104	29	509	99	23	506	99	21
717	515	26	525	102	28	500	97	22	497	97	21
<b>Mean for Weeks</b>											
1-13	231		233	101		231	100		230	100	
14-52	428		432	101		423	99		425	99	
53-103	516		520	101		500	97		505	98	

**TABLE 8**  
**Mean Body Weights and Survival of Female Rats in the 2-Year Inhalation Study of Vinylidene Chloride**

Day	Chamber Control		25 ppm			50 ppm			100 ppm		
	Av. Wt. (g)	No. of Survivors	Av. Wt. (g)	Wt. (% of Controls)	No. of Survivors	Av. Wt. (g)	Wt. (% of Controls)	No. of Survivors	Av. Wt. (g)	Wt. (% of Controls)	No. of Survivors
1	88	50	87	99	50	87	99	50	87	99	50
10	111	50	108	98	50	107	97	50	104	94	50
17	125	50	123	99	50	122	98	50	119	95	50
24	139	50	137	99	50	135	98	50	132	95	50
31	150	50	150	100	50	150	100	50	146	97	50
38	158	50	159	101	50	157	99	50	154	97	50
45	167	50	167	100	50	165	99	50	162	97	50
52	173	50	173	100	50	170	98	50	168	97	50
59	178	50	178	100	50	175	98	50	173	97	50
66	183	50	181	99	50	180	99	50	177	97	50
73	188	50	186	99	50	185	99	50	182	97	50
80	191	50	192	101	50	191	100	50	187	98	50
87	196	50	197	100	50	194	99	50	191	98	50
115	211	50	213	101	50	210	99	50	207	98	50
143	222	50	225	101	50	221	99	50	218	98	49
171	235	50	237	101	50	234	100	50	232	99	49
199	245	50	249	102	50	245	100	50	243	99	49
227	254	50	258	102	50	254	100	50	252	99	49
255	264	50	267	101	50	264	100	50	260	99	49
283	273	50	276	101	50	272	100	50	268	98	49
311	284	50	286	101	50	283	100	50	279	98	49
339	298	50	301	101	50	297	100	50	292	98	49
367	308	50	312	101	50	307	100	50	300	98	49
395	321	50	328	102	50	325	101	50	318	99	48
423	330	50	337	102	50	331	100	48	323	98	48
451	338	50	344	102	49	335	99	48	331	98	48
479	343	50	352	103	48	342	100	48	333	97	48
507	350	50	357	102	48	346	99	48	339	97	48
535	352	50	359	102	47	350	99	45	343	98	48
563	358	48	365	102	45	355	99	43	346	97	48
591	362	47	371	102	44	360	99	41	354	98	45
619	370	46	374	101	41	367	99	39	357	97	44
647	376	45	379	101	37	367	98	37	357	95	40
661	375	43	382	102	34	370	99	36	362	97	35
675	374	41	379	102	33	380	102	33	364	97	33
689	372	39	376	101	32	380	102	33	358	96	30
703	372	34	378	102	30	379	102	32	356	96	25
717	370	34	389	105	27	382	103	31	366	99	21
<b>Mean for Weeks</b>											
1-13	157		157	100		155	99		152	97	
14-52	254		257	101		253	100		250	98	
53-103	354		361	102		355	100		344	97	

## Pathology and Statistical Analyses

This section describes the statistically significant or biologically noteworthy changes in the incidences of malignant mesothelioma and mononuclear cell leukemia, and neoplasms and/or nonneoplastic lesions of the thyroid gland, kidney, urinary bladder, nose, lung, liver, ovary, clitoral gland, and mesentery. Summaries of the incidences of neoplasms and nonneoplastic lesions, statistical analyses of primary neoplasms that occurred with an incidence of at least 5% in at least one animal group, and historical incidences for the neoplasms mentioned in this section are presented in Appendix A for male rats and Appendix B for female rats.

*Malignant Mesothelioma:* The incidences of malignant mesothelioma occurred with a positive trend and were significantly increased in all exposed groups of males (Tables 9, A1, and A2). The peritoneal mesothelium covering the testis and epididymis was most often affected, similar to spontaneous mesothelioma. One male exposed to 25 ppm also had mesotheliomas on the pleura and pericardium in addition to the testicular and epididymal sites. Malignant mesothelioma occurred in one 25 ppm female (pleura, pericardium) and one exposed to 50 ppm (peritoneum); these incidences were greater than those in the chamber control group, and no malignant mesotheliomas have occurred in 700 females in the historical control database (Tables 9 and B1). Malignant mesothelioma was characterized by sessile to arboriform and papillary proliferations of large, plump mesothelial cells with large nuclei, prominent nucleoli, and scant to moderate cytoplasm, supported by a fibrovascular stroma (Plate 1). In males, these neoplasms originated in the epididymis and testes, and disseminated throughout the peritoneum to multiple organs including the intestines, mesentery, pancreas, prostate gland, spleen, and liver.

Global gene expression profiling of mesotheliomas arising in male F344/N rats exposed to vinylidene chloride, spontaneous mesotheliomas in F344/N rats, and cultured rat mesothelial cells (Fred-PE cells) showed that mesotheliomas from vinylidene chloride-exposed animals and control animals could be differentiated based on their genomic profiles, despite indistinguishable morphology. Moreover, while spontaneous mesotheliomas and mesotheliomas from vinylidene chloride-exposed animals harbored many similarities in pathway and gene dysregulation, including those associated with oncogenesis, growth factor pathways, embryonic development, matrix remodeling, and mesothelial markers, mesotheliomas from vinylidene chloride-exposed animals were distinguished from spontaneous mesotheliomas based on overrepresentation of genes associated with a

**TABLE 9**  
**Incidences of Malignant Mesothelioma in Rats in the 2-Year Inhalation Study of Vinylidene Chloride**

	Chamber Control	25 ppm	50 ppm	100 ppm
<b>Male</b>				
All Organs: Malignant Mesothelioma <sup>a</sup>				
Overall rate <sup>b</sup>	1/50 (2%)	12/50 (24%)	28/50 (56%)	23/50 (46%)
Adjusted rate <sup>c</sup>	2.4%	27.9%	63.4%	52.7%
Terminal rate <sup>d</sup>	0/25 (0%)	5/27 (19%)	10/22 (46%)	7/19 (37%)
First incidence (days)	562	535	500	449
Poly-3 test <sup>e</sup>	P<0.001	P<0.001	P<0.001	P<0.001
<b>Female</b>				
All Organs: Malignant Mesothelioma <sup>f</sup>				
Overall rate	0/50 (0%)	1/50 (2%)	1/50 (2%)	0/50 (0%)
Adjusted rate	0.0%	2.4%	2.4%	0.0%
Terminal rate	0/30 (0%)	1/26 (4%)	0/29 (0%)	0/19 (0%)
First incidence (days)	— <sup>g</sup>	781 (T)	634	—
Poly-3 test	— <sup>h</sup>	—	—	—

(T) Terminal kill

<sup>a</sup> Historical incidence for 2-year inhalation studies with chamber control groups (mean ± standard deviation): 1/200 (0.5% ± 1.0%), range 0%-2%; all routes: 26/699 (3.7% ± 3.1%), range 0%-8%

<sup>b</sup> Number of animals with malignant mesothelioma per number of animals necropsied

<sup>c</sup> Poly-3 estimated neoplasm incidence after adjustment for intercurrent mortality

<sup>d</sup> Observed incidence at terminal kill

<sup>e</sup> Beneath the chamber control incidence is the P value associated with the trend test. Beneath the exposed group incidence are the P values corresponding to pairwise comparisons between the chamber controls and that exposed group. The Poly-3 test accounts for differential mortality in animals that do not reach terminal kill.

<sup>f</sup> Historical incidence for inhalation studies 0/200; all routes: 0/700

<sup>g</sup> Not applicable; no neoplasms in animal group

<sup>h</sup> Value of statistic not computed because all exposure groups have fewer than two neoplasms.

proinflammatory response and immune dysregulation, including alterations in pathways associated with proinflammatory cytokines and chemokines, Jak/Stat mediators, complement factors, pattern recognition receptors and damage-associated molecular pattern molecules, interferon pathway mediators, activated macrophage products, cell surface receptors, and a variety of inflammatory mediators.

*Thyroid Gland (C-Cell)*: The incidence of C-cell adenoma was significantly increased in 100 ppm females, exceeded the historical control range for inhalation studies, and was at the upper end of the historical control range for all routes of administration (Tables 10, B1, B2, and B3a). Incidences of carcinoma were increased in all exposed groups of females, and the incidence in the 25 ppm group was significantly greater than that in the chamber controls.

**TABLE 10**  
**Incidences of Neoplasms of the Thyroid Gland (C-Cell) in Female Rats**  
**in the 2-Year Inhalation Study of Vinylidene Chloride**

	Chamber Control	25 ppm	50 ppm	100 ppm
<b>Adenoma<sup>a</sup></b>				
Overall rate <sup>b</sup>	3/50 (6%)	4/50 (8%)	6/48 (13%)	11/50 (22%)
Adjusted rate <sup>c</sup>	6.6%	9.5%	14.6%	26.2%
Terminal rate <sup>d</sup>	3/30 (10%)	2/26 (8%)	4/28 (14%)	6/19 (32%)
First incidence (days)	731 (T)	625	579	669
Poly-3 test <sup>e</sup>	P=0.004	P=0.461	P=0.195	P=0.012
<b>Carcinoma<sup>f</sup></b>				
Overall rate	0/50 (0%)	6/50 (12%)	2/48 (4%)	2/50 (4%)
Adjusted rate	0.0%	14.4%	4.9%	4.8%
Terminal rate	0/30 (0%)	6/26 (23%)	1/28 (4%)	1/19 (5%)
First incidence (days)	— <sup>g</sup>	731 (T)	670	670
Poly-3 test	P=0.474	P=0.011	P=0.213	P=0.218
<b>Adenoma or Carcinoma<sup>h</sup></b>				
Overall rate	3/50 (6%)	10/50 (20%)	8/48 (17%)	13/50 (26%)
Adjusted rate	6.6%	23.7%	19.3%	30.8%
Terminal rate	3/30 (10%)	8/26 (31%)	5/28 (18%)	7/19 (37%)
First incidence (days)	731 (T)	625	579	669
Poly-3 test	P=0.006	P=0.023	P=0.071	P=0.003

(T) Terminal kill

<sup>a</sup> Historical incidence for 2-year inhalation studies with chamber control groups (mean ± standard deviation): 13/200 (6.5% ± 1.0%), range 6%-8%; all routes: 81/690 (11.7% ± 5.5%), range 6%-22%

<sup>b</sup> Number of animals with neoplasm per number of animals with thyroid gland examined microscopically

<sup>c</sup> Poly-3 estimated neoplasm incidence after adjustment for intercurrent mortality

<sup>d</sup> Observed incidence at terminal kill

<sup>e</sup> Beneath the chamber control incidence is the P value associated with the trend test. Beneath the exposed group incidence are the P values corresponding to pairwise comparisons between the chamber controls and that exposed group. The Poly-3 test accounts for differential mortality in animals that do not reach terminal kill.

<sup>f</sup> Historical incidence for inhalation studies: 1/200 (0.5% ± 1.0%), range 0%-2%; all routes: 6/690 (0.9% ± 2.0%), range 0%-7%

<sup>g</sup> Not applicable; no neoplasms in animal group

<sup>h</sup> Historical incidence for inhalation studies: 14/200 (7.0% ± 1.2%), range 6%-8%; all routes: 87/690 (12.7% ± 5.8%), range 6%-22%

The incidences of carcinoma in all exposed groups of females exceeded the historical control range for inhalation studies, and the incidence in the 25 ppm group exceeded the historical control range for all routes of administration.

The incidences of adenoma or carcinoma (combined) were significantly increased in 25 and 100 ppm females.

Thyroid gland C-cell adenomas were characterized by a discrete, small, well-demarcated focal proliferation of well-differentiated C-cells that comprised greater than the diameter of five contiguous follicles and caused variable compression of the adjacent thyroid gland parenchyma (Plate 2). Carcinomas were more infiltrative, less well-differentiated, and typically showed evidence of cellular atypia and mitotic activity (Plate 3).



*Mononuclear Cell Leukemia:* The incidence of mononuclear cell leukemia was significantly increased in 100 ppm females and exceeded the historical control ranges for inhalation studies and all routes of administration (Tables 11, B1, B2, and B3b).

**TABLE 11**  
**Incidences of Mononuclear Cell Leukemia in Female Rats**  
**in the 2-Year Inhalation Study of Vinylidene Chloride**

	Chamber Control	25 ppm	50 ppm	100 ppm
All Organs: Mononuclear Cell Leukemia <sup>a</sup>				
Overall rate <sup>b</sup>	10/50 (20%)	11/50 (22%)	13/50 (26%)	25/50 (50%)
Adjusted rate <sup>c</sup>	21.4%	24.6%	28.3%	54.6%
Terminal rate <sup>d</sup>	3/30 (10%)	4/26 (15%)	3/29 (10%)	8/19 (42%)
First incidence (days)	631	451	421	395
Poly-3 test <sup>e</sup>	P<0.001	P=0.457	P=0.300	P<0.001

<sup>a</sup> Historical incidence for 2-year inhalation studies with chamber control groups (mean  $\pm$  standard deviation): 58/200 (29.0%  $\pm$  6.2%), range 20%-34%; all routes: 165/700 (23.6%  $\pm$  8.2%), range 10%-36%

<sup>b</sup> Number of animals with mononuclear cell leukemia per number necropsied

<sup>c</sup> Poly-3 estimated neoplasm incidence after adjustment for intercurrent mortality

<sup>d</sup> Observed incidence at terminal kill

<sup>e</sup> Beneath the chamber control incidence is the P value associated with the trend test. Beneath the exposed group incidence are the P values corresponding to pairwise comparisons between the chamber controls and that exposed group. The Poly-3 test accounts for differential mortality in animals that do not reach terminal kill.

*Kidney:* In the standard evaluation of the kidney, two 25 ppm males, one 50 ppm male, and one 100 ppm male had renal tubule carcinomas (Tables 12 and A1). Carcinomas were characterized by large, infiltrative proliferations of lobules and tubules of poorly differentiated renal tubule epithelial cells (Plate 4). Although not statistically significant, the incidence in the 25 ppm group exceeded the historical control ranges for inhalation studies and all routes of administration (Tables 12 and A3b). There was a single incidence of renal tubule adenoma in 50 ppm females; no renal tubule adenomas have occurred in 692 females in the historical control database (Tables 12 and B1). Renal tubule adenoma was composed of a small, expansile proliferation of fairly well-differentiated renal tubule epithelial cells causing compression of adjacent renal parenchyma (Plate 5).

Single incidences of renal tubule hyperplasia occurred in each exposed group of males, and slight increases in the incidences of this lesion occurred in 25 and 100 ppm females (Tables 12, A4, and B4). This lesion did not occur in the concurrent chamber control males and was increased in severity in 100 ppm males. Renal tubule hyperplasia was characterized by few multifocal foci of enlarged tubule epithelial cells piling and filling the tubule lumen, often expanding to involve multiple tubule profiles (Plate 6). Hyperplasia of the transitional epithelium of the kidney occurred in one 50 ppm and two 100 ppm males and was characterized by similar crowding and piling of well-differentiated transitional epithelial cells.

Since there was evidence of a treatment-related effect in male rats, kidney step sections were performed to evaluate for additional proliferative lesions. The findings of the kidney step section evaluation in male rats (Table 12) indicated increased incidences of renal tubule hyperplasia in all exposed groups. Several newly diagnosed incidences of renal tubule adenoma were observed as a result of kidney step section review in male rats, although there was not a significant difference between exposed animals and chamber controls. No additional carcinomas were observed as the result of step section review. The final combined incidences of renal tubule adenoma or carcinoma resulting from the kidney step section review indicated slightly increased incidences in 25 and 50 ppm male rats compared with concurrent chamber controls, but not in the 100 ppm group; one 25 ppm male had both an adenoma and a carcinoma.

**TABLE 12**  
**Incidences of Neoplasms and Nonneoplastic Lesions of the Kidney in Rats in the 2-Year Inhalation Study of Vinylidene Chloride**

	Chamber Control	25 ppm	50 ppm	100 ppm
<b>Male</b>				
<b>Single Sections (Standard Evaluation)</b>				
Number Examined Microscopically	50	50	49	50
Renal Tubule, Hyperplasia <sup>a</sup>	0	1 (2.0) <sup>b</sup>	1 (1.0)	1 (4.0)
Transitional Epithelium, Hyperplasia	0	0	1 (3.0)	2 (1.5)
Renal Tubule, Carcinoma <sup>c</sup>	0	2	1	1
<b>Step Sections (Extended Evaluation)</b>				
Number Examined Microscopically	50	50	49	50
Renal Tubule Hyperplasia	3 (1.0)	5 (1.2)	5 (2.2)	7 (2.0)
Renal Tubule Adenoma	3	3	5	1
<b>Single and Step Sections (Combined)</b>				
Number Examined Microscopically	50	50	49	50
Renal Tubule Hyperplasia	3	5	6	8
Renal Tubule Adenoma	3	3	5	1
Renal Tubule Carcinoma	0	2	1	1
Renal Tubule Adenoma or Carcinoma				
Overall rate <sup>d</sup>	3/50 (6%)	4/50 (8%)	6/49 (12%)	2/50 (4%)
Adjusted rate <sup>e</sup>	7.2%	9.8%	15.7%	5.3%
Terminal rate <sup>f</sup>	3/25 (12%)	1/27 (4%)	4/22 (18%)	1/19 (5%)
First incidence (days)	729 (T)	631	502	718
Poly-3 test <sup>g</sup>	P=0.485N	P=0.484	P=0.194	P=0.546N
<b>Female</b>				
Number Examined Microscopically	50	50	50	50
Renal Tubule, Hyperplasia	1 (2.0)	2 (2.5)	0	2 (3.0)
Renal Tubule, Adenoma <sup>h</sup>	0	0	1	0

(T) Terminal kill

<sup>a</sup> Number of animals with lesion

<sup>b</sup> Average severity grade of lesions in affected animals: 1=minimal, 2=mild, 3=moderate, 4=marked

<sup>c</sup> Historical incidence for 2-year inhalation studies with chamber control groups (mean ± standard deviation): 0/200; all routes: 1/697 (0.1% ± 0.5%), range 0%-2%

<sup>d</sup> Number of animals with neoplasm per number of animals with kidney examined microscopically

<sup>e</sup> Poly-3 estimated neoplasm incidence after adjustment for intercurrent mortality

<sup>f</sup> Observed incidence at terminal kill

<sup>g</sup> Beneath the chamber control incidence is the P value associated with the trend test. Beneath the exposed group incidence are the P values corresponding to pairwise comparisons between the chamber controls and that exposed group. The Poly-3 test accounts for differential mortality in animals that do not reach terminal kill. A negative trend or a lower incidence in an exposure group is indicated by N.

<sup>h</sup> Historical incidence for inhalation studies: 0/199; all routes: 0/692

*Urinary Bladder:* Carcinoma of the transitional epithelium occurred in two 25 ppm males (Table A1); this incidence exceeded the historical control ranges for inhalation studies (0%; 0/50) and all routes of administration (0% to 2%; 1/698). Hyperplasia of the transitional epithelium of the urinary bladder, characterized by increased layers of well-differentiated transitional epithelial cells lining the mucosa, occurred in one 50 ppm and two 100 ppm males (Table A4). The biologic significance of this neoplasm is uncertain; the incidence of this neoplasm was not believed to be related to vinylidene chloride exposure.

*Nose:* The only exposure-related primary nasal neoplasm observed was adenoma of the respiratory epithelium that was diagnosed in one 50 ppm and four 100 ppm male rats and one 100 ppm female rat (Tables 13, A1, A2, and B1). No respiratory epithelium adenomas have been seen in male historical controls, and the incidence in 100 ppm females exceeded the historical control range for inhalation studies (Tables 13 and B3c). Adenomas were typically small, polypoid masses arranged in glandular or papillary patterns and arose from the transitional epithelium lining the nasotubinate or the lateral wall of Level I (Plate 7). Neoplastic cells were relatively well differentiated, moderately sized, and polygonal with moderate amounts of lightly granular eosinophilic cytoplasm. Nuclei were also moderately sized and round to oval, with lightly stippled chromatin and one to two prominent basophilic to amphophilic nucleoli.

A variety of nonneoplastic lesions were observed in the nose of male and female rats exposed to vinylidene chloride. Exposure-related nonneoplastic nasal lesions primarily affected Level III, but often extended into Levels II and/or I in 100 ppm rats, depending on the lesion. Turbinate atrophy was a striking lesion that occurred in every exposed male and female rat (Tables 13, A4, and B4). This lesion was accompanied in most cases with turbinate hyperostosis, and the severity of both lesions increased with increasing exposure concentration. These lesions were not observed in chamber control rats. Turbinate atrophy was characterized by blunting, shortening, and sometimes loss of turbinates, particularly in Level III. Turbinate hyperostosis was characterized by bony remodeling resulting in thickened, nodular, misshapen turbinate bones. The turbinate changes were observed with and without extensive changes to the overlying epithelium, including respiratory metaplasia.

**TABLE 13**  
**Incidences of Neoplasms and Nonneoplastic Lesions of the Nose and Lung in Rats**  
**in the 2-Year Inhalation Study of Vinylidene Chloride**

	Chamber Control	25 ppm	50 ppm	100 ppm
<b>Male</b>				
Nose <sup>a</sup>	49	50	50	50
Turbinate, Atrophy <sup>b</sup>	0	50** (2.2) <sup>c</sup>	50** (3.2)	50** (3.8)
Turbinate, Hyperostosis	0	49** (2.1)	50** (2.6)	50** (2.9)
Olfactory Epithelium, Metaplasia, Respiratory	3 (1.0)	49** (2.5)	49** (3.2)	48** (3.5)
Olfactory Epithelium, Metaplasia, Squamous	0	0	1 (2.0)	5* (1.2)
Respiratory Epithelium, Hyperplasia	5 (1.6)	8 (1.5)	22** (2.5)	31** (2.3)
Inflammation, Chronic Active	9 (1.2)	36** (2.0)	45** (2.7)	48** (3.2)
Thrombosis	4 (2.3)	4 (3.0)	11* (3.3)	7 (2.7)
Respiratory Epithelium, Adenoma <sup>d</sup>				
Overall rate <sup>e</sup>	0/49 (0%)	0/50 (0%)	1/50 (2%)	4/50 (8%)
Adjusted rate <sup>f</sup>	0.0%	0.0%	2.7%	10.5%
Terminal rate <sup>g</sup>	0/25 (0%)	0/27 (0%)	1/22 (5%)	3/19 (16%)
First incidence (days)	— <sup>i</sup>	—	729 (T)	635
Poly-3 test <sup>h</sup>	P=0.004	— <sup>j</sup>	P=0.483	P=0.051
Lung	50	50	50	50
Alveolar Epithelium Hyperplasia	7 (1.1)	18** (1.5)	14* (1.6)	14* (2.3)
<b>Female</b>				
Nose	50	50	50	50
Turbinate, Atrophy	0	50** (2.8)	50** (3.3)	50** (4.0)
Turbinate, Hyperostosis	0	50** (1.9)	50** (2.6)	50** (2.8)
Olfactory Epithelium, Metaplasia, Respiratory	1 (1.0)	50** (2.8)	50** (3.1)	50** (3.6)
Respiratory Epithelium, Hyperplasia	4 (1.3)	12* (1.6)	14** (1.7)	27** (2.1)
Inflammation, Chronic Active	7 (1.4)	45** (1.8)	46** (2.0)	46** (2.9)
Thrombosis	0	3 (2.3)	2 (2.0)	7** (2.3)
Polyp, Inflammatory	0	0	0	3 (3.0)
Respiratory Epithelium, Adenoma <sup>k</sup>	0	0	0	1

\* Significantly different (P<0.05) from the chamber control group by the Poly-3 test

\*\* P<0.01

(T)Terminal kill

<sup>a</sup> Number of animals with tissue examined microscopically

<sup>b</sup> Number of animals with lesion

<sup>c</sup> Average severity grade of lesions in affected animals: 1=minimal, 2=mild, 3=moderate, 4=marked

<sup>d</sup> Historical incidence for 2-year inhalation studies with chamber control groups (mean ± standard deviation): 0/198; all routes: 0/697

<sup>e</sup> Number of animals with neoplasm per number of animals with nose examined microscopically

<sup>f</sup> Poly-3 estimated neoplasm incidence after adjustment for intercurrent mortality

<sup>g</sup> Observed incidence at terminal kill

<sup>h</sup> Beneath the chamber control incidence is the P value associated with the trend test. Beneath the exposed group incidence are the P values corresponding to pairwise comparisons between the chamber controls and that exposed group. The Poly-3 test accounts for differential mortality in animals that do not reach terminal kill.

<sup>i</sup> Not applicable; no neoplasms in animal group

<sup>j</sup> Value of statistic cannot be computed.

<sup>k</sup> Historical incidence for inhalation studies: 0/200; all routes: 1/697 (0.1% ± 0.5%), range 0%-2%

Olfactory epithelium respiratory metaplasia occurred in most exposed rats with exposure concentration-related increases in severity (Tables 13, A4, and B4). This lesion was characterized by atrophy and replacement of the multilayered olfactory epithelium by a single layer of ciliated columnar epithelium. The metaplastic epithelium was often hyperplastic, with numerous folds in the mucosa, extending into the underlying lamina propria (pseudogland formation). Olfactory epithelium squamous metaplasia was less commonly observed, and the incidence in the 100 ppm males was significantly increased. This lesion was characterized by loss of olfactory epithelium and replacement by single to multiple layers of flattened squamous epithelial cells.

Exposure concentration-related increased incidences of respiratory epithelium hyperplasia occurred in male and female rats, and the incidences in 50 and 100 ppm males and in all exposed groups of females were significantly greater than those in the chamber controls (Tables 13, A4, and B4). This lesion was characterized by thickening of the respiratory epithelium by increased numbers of cuboidal to ciliated columnar epithelial cells crowded in multiple layers, sometimes forming undulations with invaginations into the underlying lamina propria.

Incidences of chronic active inflammation were significantly increased in all exposed groups of male and female rats compared to the concurrent chamber controls, and the severities of the lesion increased with increasing exposure concentration (Tables 13, A4, and B4). Chronic active inflammation was most prominent in Level III, but also affected Levels II and/or I when it was most severe. Inflammation was characterized by collections of neutrophils and mononuclear inflammatory cells in the airways or in the nasal mucosae. Incidences of thrombosis were sporadically observed in nasal vessels of male and female rats, particularly in the dorsal aspects of Level I; incidences of this lesion were significantly increased in 50 ppm males and 100 ppm females. Inflammatory polyp occurred in three 100 ppm females; this lesion was characterized by exophytic and pedunculated masses within the nasal cavity, composed of loose connective tissue covered by a single layer of respiratory epithelium.

*Lung:* The incidences of alveolar epithelium hyperplasia were significantly increased in all exposed groups of males (Tables 13 and A4). In addition, an exposure concentration-related increase in severities of this lesion occurred. Alveolar epithelium hyperplasia was characterized by focal, discrete proliferations of flat to cuboidal, low columnar

or hypertrophied epithelial cells (Type II pneumocytes) lining the alveolar septae that were thickened by increased amounts of interstitial collagen.

*Liver:* Significantly increased incidences of chronic inflammation occurred in all exposed groups of rats (Tables 14, A4, and B4). While chamber control rats of both sexes had infiltrates composed of histiocytes and lymphocytes, chronic inflammation in exposed animals was characterized by lipid-laden macrophages as a predominant component of the inflammatory reaction. Severities of inflammation increased with increasing exposure concentration. In some rat livers, a granulomatous reaction characterized by histiocytes and variably sized multinucleated giant cells with abundant cytoplasm were observed. Increased incidences of diffuse fatty change occurred in all exposed groups of rats and severities of the lesion were increased in exposed groups of females. This lesion consisted of individual cells with micro and macrovesicular accumulation of intracellular lipid scattered throughout the parenchyma. Areas of diffuse fatty change often coalesced and bridged into bands throughout the tissue. Significantly increased incidences of necrosis occurred in the 50 ppm male and 50 and 100 ppm female rats.

**TABLE 14**  
**Incidences of Nonneoplastic Lesions of the Liver in Rats in the 2-Year Inhalation Study**  
**of Vinylidene Chloride**

	Chamber Control	25 ppm	50 ppm	100 ppm
<b>Male</b>				
Number Examined Microscopically	50	50	50	50
Inflammation Chronic <sup>a</sup>	28 (1.0) <sup>b</sup>	46** (1.2)	46** (1.3)	44** (1.9)
Fatty Change, Diffuse	4 (2.0)	19** (1.7)	18** (1.7)	26** (2.0)
Necrosis	2 (2.5)	6 (2.8)	8* (2.6)	6 (2.3)
Degeneration, Cystic	2 (2.0)	5 (2.8)	7 (1.9)	12** (2.1)
<b>Female</b>				
Number Examined Microscopically	50	50	50	50
Inflammation, Chronic	42 (1.0)	48* (1.4)	49** (1.4)	48** (2.1)
Fatty Change, Diffuse	19 (1.2)	30* (1.7)	26 (1.7)	30** (2.0)
Necrosis	0	3 (1.7)	5* (2.2)	11** (1.8)
Degeneration, Cystic	0	2 (3.0)	4* (2.3)	7** (2.7)

\* Significantly different (P≤0.05) from the chamber control group by the Poly-3 test

\*\* P≤0.01

<sup>a</sup> Number of animals with lesion

<sup>b</sup> Average severity grade of lesions in affected animals: 1=minimal, 2=mild, 3=moderate, 4=marked

Necrosis was characterized by focal hypereosinophilia, nuclear pyknosis and karyolysis, and loss of normal hepatic cord architecture. Incidences of cystic degeneration were significantly increased in the 100 ppm male and 50 and 100 ppm female rats compared to concurrent chamber controls. This lesion was characterized by hepatocellular dropout resulting in the formation of multifocal cyst-like structures sometimes containing finely granular or flocculent eosinophilic material or erythrocytes.

*Ovary:* Incidences of bursa dilatation increased in an exposure concentration-related manner (chamber control, 5/50; 25 ppm, 11/50; 50 ppm, 17/50; 100 ppm, 24/50; Table B4). Severities of bursa dilatation were increased in all exposed female groups (1.8, 3.1, 3.1, 3.2). This lesion was characterized by a diffuse distension of the space between the ovary and its bursal covering, with thinning of the bursal wall. The biologic relevance of this lesion in exposed rats is uncertain.

*Other Organs:* The incidence of clitoral gland adenoma in 25 ppm females was greater than that in the chamber controls (4/47, 8/48, 3/45, 4/48; Tables B1 and B2) and exceeded the historical control range for inhalation studies [8/196 (4.2% ± 3.9%, range 0%-9%)], but was within the historical control range for all routes of administration [56/696 (8.1% ± 6.1%, range 0% to 24%)]. In addition, the incidence of this neoplasm in the concurrent chamber controls is the highest incidence in inhalation studies in the historical database. The incidence of clitoral gland carcinoma was increased in 100 ppm females (1/47, 0/48, 0/45, 5/48). The biologic significance of this neoplasm is uncertain; the incidence of this neoplasm was not believed to be related to vinylidene chloride exposure.

Incidences of fat necrosis of the mesentery were prevalent in all exposed groups of female rats (13/13, 19/20, 22/23, 23/24; Table B4), and severities of the lesion were unaffected by exposure concentration (2.0, 2.0, 2.0, 2.0).

Histologic evaluation of this lesion was only performed when gross lesions in the mesenteric fat were observed. Fat necrosis of the mesentery was characterized by saponification and loss of normal adipocyte architecture admixed with karyorrhectic and mineralized debris. The pathogenesis of this lesion and its biologic significance are uncertain. There is also a treatment- and exposure concentration-related increase in fat necrosis in the companion mouse study. Localized fat necrosis may be related to the inflammatory lesions in the liver; however, this needs to be further substantiated.



## MICE

### 2-WEEK STUDY

All male mice exposed to 100 ppm or greater died within the first 4 days of exposure (Table 15). All females exposed to 200 or 400 ppm were found dead following exposure on day 1. One 50 ppm male and one 100 ppm female were removed dead before exposure on day 5. The mean body weight gains of 25 and 50 ppm males were significantly less than that of the chamber controls; the final mean body weights of these groups were 8% and 7% less, respectively, than that of the chamber control group. Lethargy occurred in two of five 50 ppm males and all 100 ppm males. Abnormal breathing occurred in one of five 50 ppm males and four of five 100 ppm males. All 100 ppm female mice became thin, while one female exposed at this level also became lethargic, developed tremors, and was breathing abnormally.

In all surviving groups of exposed females, absolute and relative lung weights were significantly greater than those of the chamber controls (Table G3). Absolute and relative liver weights of 50 and 100 ppm females and relative liver weights of 25 ppm females and 25 and 50 ppm males were significantly greater than those of the chamber controls.

Gross lesions were observed at 100 ppm and included pale or mottled livers in one male and one female, and pale kidney in one male mouse that survived more than 1 day of exposure.

**TABLE 15**  
**Survival and Body Weights of Mice in the 2-Week Inhalation Study of Vinylidene Chloride<sup>a</sup>**

Concentration (ppm)	Survival <sup>b</sup>	Initial Body Weight (g)	Final Body Weight (g)	Change in Body Weight (g)	Final Weight Relative to Controls (%)
<b>Male</b>					
0	5/5	23.1 ± 0.6	26.6 ± 0.9	3.6 ± 0.6	
25	5/5	23.6 ± 0.3	24.4 ± 0.9	0.8 ± 0.6*	92
50	4/5 <sup>c</sup>	23.6 ± 0.4	24.9 ± 0.2	1.3 ± 0.6*	93
100	0/5 <sup>d</sup>	23.7 ± 0.2	—	—	
200	0/5 <sup>e</sup>	23.3 ± 0.4	—	—	
400	0/5 <sup>e</sup>	23.3 ± 0.6	—	—	
<b>Female</b>					
0	5/5	19.7 ± 0.4	22.2 ± 0.4	2.5 ± 0.4	
25	5/5	19.9 ± 0.2	21.8 ± 0.5	2.0 ± 0.5	98
50	5/5	19.4 ± 0.4	21.4 ± 0.3	2.0 ± 0.4	96
100	4/5 <sup>c</sup>	19.6 ± 0.4	22.2 ± 0.7	2.5 ± 0.2	100
200	0/5 <sup>e</sup>	19.7 ± 0.4	—	—	
400	0/5 <sup>e</sup>	19.1 ± 0.2	—	—	

\* Significantly different ( $P \leq 0.05$ ) from the chamber control group by Dunnett's test

<sup>a</sup> Weights and weight changes are given as mean ± standard error. Subsequent calculations are based on animals surviving to the end of the study.

<sup>b</sup> Number of animals surviving at 17 days/number initially in group

<sup>c</sup> Day of death: 5

<sup>d</sup> Days of deaths: 3, 4, 4, 4, 4

<sup>e</sup> Day of deaths: 1

In the nose, minimal necrosis of the respiratory epithelium occurred in all early-death male and female mice (Table 16). Necrosis involved the respiratory epithelium of the turbinates and lateral wall in Level I of the nose. Necrotic cells had increased cytoplasmic eosinophilia and were often sloughed into the nasal passages.

In the liver, necrosis occurred in all males and females exposed to 100 ppm or greater, and in one male exposed to 50 ppm; in addition, regeneration occurred in the four 100 ppm females that survived to the end of study (Table 16). Hepatic necrosis was moderate to marked in all early-death mice exposed to 100 ppm or greater and minimal in the one 50 ppm male. In the early-death animals, hepatic necrosis was characterized by hypereosinophilic coagulum in centrilobular or midzonal areas that often extended to periportal regions. It was minimal in the four 100 ppm female mice that survived to terminal kill and was characterized by individual hypereosinophilic hepatocytes that demonstrated nuclear karyolysis in centrilobular areas. Hepatic regeneration in these animals was most prominent

**TABLE 16**  
**Incidences of Selected Nonneoplastic Lesions in Mice in the 2-Week Inhalation Study of Vinylidene Chloride**

	Chamber Control	25 ppm	50 ppm	100 ppm	200 ppm	400 ppm
<b>Male</b>						
Nose <sup>a</sup>	5	5	5	5	5	5
Respiratory Epithelium, Necrosis <sup>b</sup>	0	0	1 (1.0) <sup>c</sup>	5** (1.0)	5** (1.0)	5** (1.0)
Liver	5	5	5	5	5	5
Necrosis	0	0	1 (1.0)	5** (3.0)	5** (4.0)	5** (4.0)
Kidney	5	5	5	5	5	5
Renal Tubule, Necrosis	0	5** (1.2)	5** (1.6)	5** (4.0)	5** (4.0)	5** (4.0)
Cast Granular	0	5** (1.8)	5** (2.2)	5** (3.0)	5** (4.0)	5** (4.0)
Renal Tubule, Regeneration	0	5** (2.8)	4* (3.0)	0	0	0
<b>Female</b>						
Nose	5	0	5	5	5	5
Respiratory Epithelium, Necrosis	0	0	0	1 (1.0)	5** (1.0)	5** (1.0)
Liver	5	0	5	5	5	5
Necrosis	0	0	0	5** (1.6)	5** (4.0)	5** (4.0)
Regeneration	0	0	0	4* (2.0)	0	0

\* Significantly different (P<0.05) from the chamber control group by the Fisher exact test

\*\* P<0.01

<sup>a</sup> Number of animals with tissue examined microscopically

<sup>b</sup> Number of animals with lesion

<sup>c</sup> Average severity grade of lesions in affected animals: 1=minimal, 2=mild, 3=moderate, 4=marked

in the midzonal region, and characterized by an increased density of hepatocytes that had increased cytoplasmic basophilia, rare binucleate forms, and mild to moderate anisokaryosis (variation in nuclear size).

In the kidney, renal tubule necrosis and granular casts occurred in every exposed male (Table 16). The occurrence of granular casts and renal tubule necrosis and regeneration in all 25 ppm males precluded the determination of a no-effect level. Incidences of marked renal tubule necrosis coincided with early deaths in all male mice exposed to 100 ppm or greater. Incidences of minimal to mild renal tubule necrosis and granular casts occurred in the 25 and 50 ppm male groups. Moderate renal tubule regeneration occurred in all 25 and 50 ppm males that survived until terminal sacrifice. Microscopically, renal tubule necrosis was characterized by attenuation, hypereosinophilia, nuclear pyknosis, and loss of tubular epithelium with sloughing into tubular lumens. Granular casts were composed of homogenous eosinophilic material, which often contained granular basophilic debris. Renal tubule regeneration

was characterized by tubules with densely packed cuboidal tubule epithelium that often obscured the lumen, with deeply basophilic cytoplasm and prominent vesicular nuclei. Mitotic figures were occasionally seen. Additionally, these animals often had a mild interstitial to subscapular mononuclear inflammatory infiltrate.

*Exposure Concentration Selection Rationale:* Based on decreased survival of males in the 2-week study, vinylidene chloride exposure concentrations selected for the 3-month inhalation study in male mice were 6.25, 12.5, 25, and 50 ppm. Due to decreased survival of female mice in the 2-week study, vinylidene chloride exposure concentrations selected for the 3-month inhalation study in female mice were 6.25, 12.5, 25, 50, and 100 ppm.

### 3-MONTH STUDY

Two 50 ppm males and four 100 ppm females died during the first week of the study; all other mice survived until terminal kill (Table 17). The final mean body weights and body weight gains of all exposed groups of females and of males exposed to 12.5 ppm or greater were significantly less than the those of the chamber control groups (Table 17 and Figure 5). There were no exposure-related clinical findings.

Gross lesions potentially related to exposure were observed in the lung (5/10) and liver (1/10) of 100 ppm female mice and the liver (1/10) and kidney (2/10) of 50 ppm male mice. Lung lesions included pale to white, 1 to 7 mm diameter foci; affected livers were mottled and/or red, and affected kidneys were diffusely pale and/or granular.

**TABLE 17**  
**Survival and Body Weights of Mice in the 3-Month Inhalation Study of Vinylidene Chloride<sup>a</sup>**

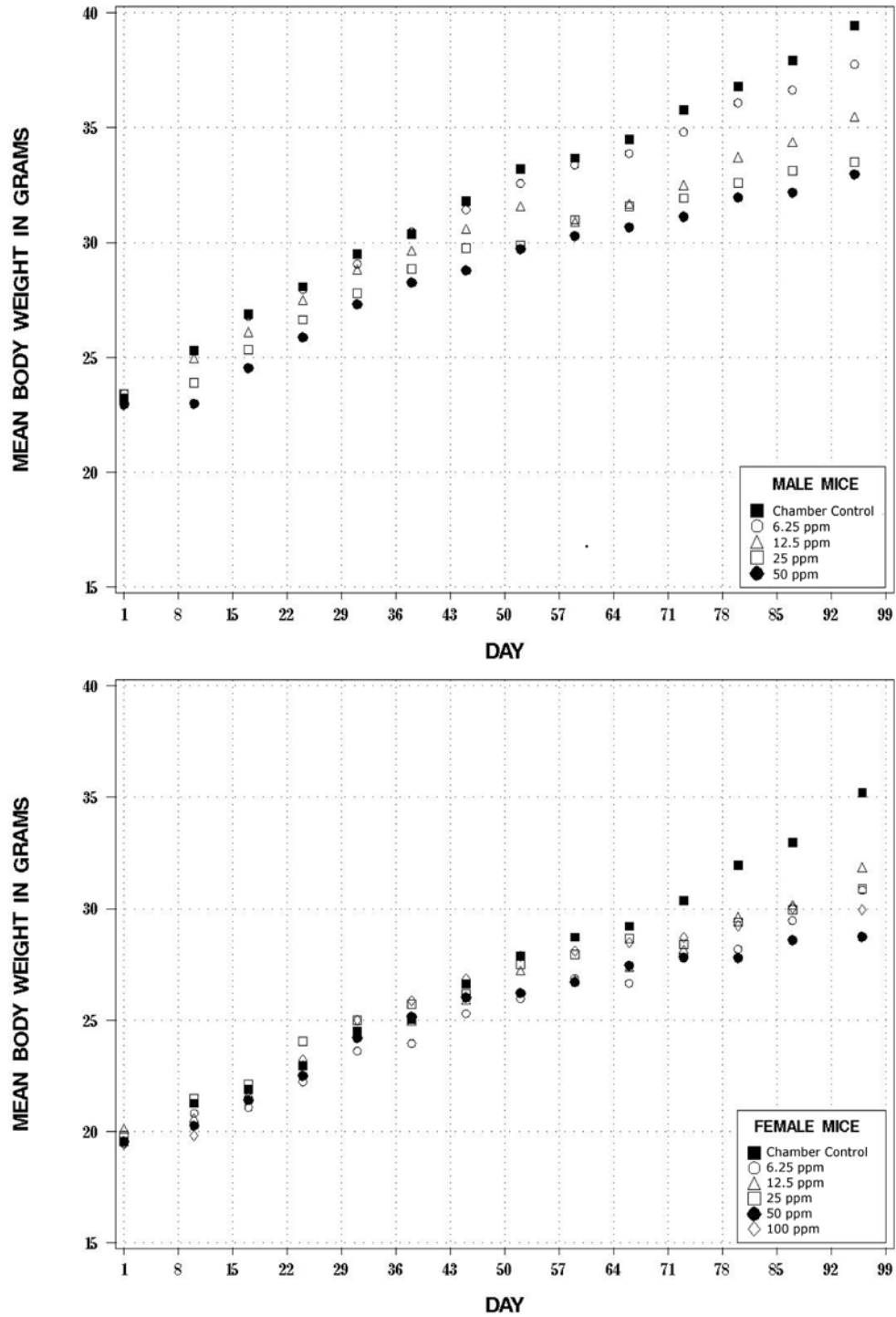
Concentration (ppm)	Survival <sup>b</sup>	Initial Body Weight (g)	Final Body Weight (g)	Change in Body Weight (g)	Final Weight Relative to Controls (%)
<b>Male</b>					
0	10/10	23.2 ± 0.4	39.4 ± 1.2	16.2 ± 1.1	
6.25	10/10	23.4 ± 0.3	37.8 ± 0.5	14.3 ± 0.3	96
12.5	10/10	23.2 ± 0.2	35.5 ± 0.6**	12.3 ± 0.6**	90
25	10/10	23.4 ± 0.2	33.5 ± 0.8**	10.1 ± 0.8**	85
50	8/10 <sup>c</sup>	22.9 ± 0.2	33.0 ± 0.5**	10.0 ± 0.4**	84
<b>Female</b>					
0	10/10	19.6 ± 0.2	35.2 ± 1.2	15.6 ± 1.2	
6.25	10/10	19.5 ± 0.4	30.8 ± 0.6**	11.4 ± 0.7**	88
12.5	10/10	20.1 ± 0.3	31.9 ± 0.9**	11.8 ± 0.7**	91
25	10/10	19.8 ± 0.3	30.9 ± 0.8**	11.1 ± 0.6**	88
50	10/10	19.6 ± 0.4	28.7 ± 0.6**	9.2 ± 0.6**	82
100	6/10 <sup>c</sup>	19.5 ± 0.4	29.9 ± 0.8**	10.0 ± 0.4**	85

\*\* Significantly different (P<0.01) from the chamber control group by Williams' test

<sup>a</sup> Weights and weight changes are given as mean ± standard error. Subsequent calculations are based on animals surviving to the end of the study.

<sup>b</sup> Number of animals surviving at 14 weeks/number initially in group

<sup>c</sup> Week of deaths: 1



**FIGURE 5**  
Growth Curves for Mice Exposed to Vinylidene Chloride by Inhalation for 3 Months

Hematology data for mice are presented in Tables 18 and F2. Exposure concentration-related decreases ( $\leq 8\%$ ) in erythrocyte counts, hemoglobin concentrations, and hematocrit values occurred at the end of the study in 12.5, 25, and 50 ppm male mice. Female mice had decreased erythrocyte counts in the 50 and 100 ppm groups, but the decreases ( $\leq 4\%$ ) were less than those in males. In addition, hemoglobin concentration and the hematocrit value were decreased in 50 ppm female mice, but not in the 100 ppm group. The erythron decreases in the 12.5 ppm and greater males and in the 50 ppm females may be related to the observed decreases in body weight.

**TABLE 18**  
**Selected Hematology Data for Mice in the 3-Month Inhalation Study of Vinylidene Chloride<sup>a</sup>**

	Chamber Control	6.25 ppm	12.5 ppm	25 ppm	50 ppm	
<b>Male</b>						
n	10	10	10	10	8	
Erythrocytes (10 <sup>6</sup> /μL)	10.18 ± 0.09	9.96 ± 0.09	9.74 ± 0.07**	9.54 ± 0.07**	9.40 ± 0.08**	
Hemoglobin (g/dL)	15.5 ± 0.1	15.1 ± 0.1	14.9 ± 0.1**	14.5 ± 0.1**	14.2 ± 0.1**	
Hematocrit (manual) (%)	49.9 ± 0.5	48.6 ± 0.3	47.8 ± 0.4**	46.5 ± 0.4**	45.9 ± 0.4**	
	Chamber Control	6.25 ppm	12.5 ppm	25 ppm	50 ppm	100 ppm
<b>Female</b>						
n	10	9	10	10	10	6
Erythrocytes (10 <sup>6</sup> /μL)	10.19 ± 0.09	10.08 ± 0.06	10.02 ± 0.07	9.97 ± 0.11	9.73 ± 0.09**	9.80 ± 0.08**
Hemoglobin (g/dL)	15.9 ± 0.1	15.7 ± 0.1	15.7 ± 0.1	15.6 ± 0.2	15.3 ± 0.1*	15.7 ± 0.1
Hematocrit (manual) (%)	50.2 ± 0.4	49.8 ± 0.4	49.8 ± 0.3	49.3 ± 0.4	48.3 ± 0.5**	50.3 ± 0.4

\* Significantly different ( $P \leq 0.05$ ) from the chamber control group by Dunn's or Shirley's test

\*\*  $P \leq 0.01$

<sup>a</sup> Data are given as mean ± standard error. Statistical tests were performed on unrounded data.

Absolute kidney weights of all exposed groups of males were significantly less than that of the chamber control group (Table G4). Absolute and relative liver weights of 12.5 ppm or greater females were significantly greater than those of the chamber controls, relative liver weights were also increased in 6.25 ppm females. Absolute and relative kidney and lung weights of 100 ppm females were significantly greater than those of the chamber controls. Other organ weight differences were related to reduced body weight.

Relative to the chamber controls, male mice exposed to 25 or 50 ppm exhibited nonsignificant decreases in cauda epididymis weights (18% and 10%, respectively) (Table H3). Males exposed to 12.5, 25, or 50 ppm had significant decreases in total sperm/cauda epididymis. No histopathologic changes in the contralateral organ were observed at necropsy. There were no changes in estrous cyclicity in females attributed to vinylidene chloride (Table H4). Therefore, vinylidene chloride has the potential to be a reproductive toxicant in male mice but not in female mice.

Kidney lesions, limited to males, consisted of renal tubule necrosis and protein casts formation in mice that experienced early death and nephropathy in those that survived to terminal kill (Table 19). Marked necrosis of the renal tubules and protein cast formation occurred in two 50 ppm males. Minimal to moderate nephropathy occurred in the 12.5, 25, and 50 ppm male groups. Decreases in the erythrocyte counts, hemoglobin concentration and hematocrit values also occurred in the same exposed groups. Renal tubule necrosis was seen as attenuation and/or loss of tubule epithelial cells with sloughing of pyknotic epithelial cells into tubule lumens. Renal tubule protein casts were present multifocally in tubule lumens as homogeneous, eosinophilic deposits that often contained granular basophilic cellular debris. Nephropathy was composed of minimal to mild tubule necrosis and cast formation; renal tubule regeneration; mild inflammatory infiltrates of lymphocytes, macrophages, and neutrophils within the interstitium and subcapsular areas; and occasional tubule mineralization.

Laryngeal lesions consisted of necrosis and respiratory epithelium hyperplasia and squamous metaplasia (Table 19). Necrosis was minimal and was only seen in early death 100 ppm females. Respiratory epithelium hyperplasia occurred in most 100 ppm females and respiratory epithelium squamous metaplasia occurred in a few males and many females exposed to 25 ppm or greater, with slight increases in severities and incidences in the female mice. Necrosis was characterized by marked cytoplasmic vacuolation of respiratory epithelium with flocculent to wispy



**TABLE 19**  
**Incidences of Selected Nonneoplastic Lesions in Mice in the 3-Month Inhalation Study of Vinylidene Chloride**

	Chamber Control	6.25 ppm	12.5 ppm	25 ppm	50 ppm	
<b>Male</b>						
Kidney <sup>a</sup>	10	10	10	10	10	
Renal Tubule Necrosis <sup>b</sup>	0	0	0	0	2 (4.0) <sup>c</sup>	
Renal Tubule, Casts Protein	0	0	0	0	2 (4.0)	
Nephropathy	0	0	5* (1.2)	10** (1.9)	8** (2.5)	
Larynx	10	10	10	10	10	
Respiratory Epithelium, Metaplasia, Squamous	0	0	0	1 (1.0)	4* (1.0)	
Liver	10	10	10	10	10	
Necrosis	0	0	0	0	2 (2.0)	
	Chamber Control	6.25 ppm	12.5 ppm	25 ppm	50 ppm	100 ppm
<b>Female</b>						
Larynx	10	10	10	10	9	10
Respiratory Epithelium, Hyperplasia	0	0	0	0	0	8** (1.4)
Respiratory Epithelium, Metaplasia, Squamous	1 (1.0)	0	1 (2.0)	3 (1.3)	9** (1.8)	7** (2.4)
Necrosis	0	0	0	0	0	4* (1.0)
Liver	10	10	10	10	10	10
Necrosis	0	0	1 (1.0)	0	0	4* (4.0)
Hepatocyte, Centrilobular, Hypertrophy	0	0	0	0	0	6** (2.8)
Lung	10	10	10	10	10	10
Bronchus, Epithelium, Necrosis	0	0	0	0	0	6** (2.7)
Inflammation, Histiocytic	0	0	0	0	0	6** (1.7)
Nose	10	10	10	10	10	10
Respiratory Epithelium, Necrosis	0	0	0	0	0	4* (2.5)
Turbinates, Atrophy	0	0	0	0	0	4* (1.0)

\* Significantly different (P≤0.05) from the chamber control group by the Fisher exact test

\*\* P≤0.01

<sup>a</sup> Number of animals with tissue examined microscopically<sup>b</sup> Number of animals with lesion<sup>c</sup> Average severity grade of lesions in affected animals: 1=minimal, 2=mild, 3=moderate, 4=marked

cytoplasm containing eosinophilic droplets, and individual pyknotic, hypereosinophilic cells that sloughed into the laryngeal lumen. Necrosis was most prominent dorsolateral to the ventral pouch. Respiratory epithelium hyperplasia consisted of increased size and number of respiratory epithelial cells, and was most prominent in the

epithelium overlying the submucosal glands at the base of the epiglottis. Respiratory epithelium squamous metaplasia was characterized by replacement of the normal ciliated columnar epithelium overlying the submucosal glands at the base of the epiglottis with approximately two to four layers of nonkeratinized, polygonal to flattened squamous epithelial cells.

Nonneoplastic lesions of the liver included necrosis in male and female mice and centrilobular hepatocyte hypertrophy in female mice (Table 19). Necrosis was marked in early death 100 ppm females and mild in early death 50 ppm males. Hepatic necrosis was not evident in the 50 ppm mice that survived to terminal kill. Mild to moderate centrilobular hepatocyte hypertrophy was observed in six 100 ppm female mice. Necrosis in mice that died early ranged from piecemeal necrosis (individual hypereosinophilic hepatocytes with nuclear pyknosis and karyolysis) to more extensive necrosis, characterized by a hypereosinophilic coagulum within the centrilobular to midzonal regions that often extended into periportal areas. Centrilobular hepatocyte hypertrophy was characterized by increased numbers of enlarged hepatocytes within centrilobular areas containing more deeply basophilic cytoplasm and enlarged, occasionally binucleate nuclei, moderate variation in nuclear size (anisokaryosis), and mitotic figures.

Exposure-related lung lesions were limited to 100 ppm female mice and consisted of bronchial epithelium necrosis and histiocytic inflammation (Table 19). Bronchial epithelium necrosis occurred in one early death female and five females that survived to terminal kill, and histiocytic inflammation occurred in all of the females that survived to terminal kill. Microscopically, bronchial epithelium necrosis was characterized by fragmentation and hypereosinophilia of bronchial epithelial cells, with sloughing into bronchial lumens. Histiocytic inflammation was characterized by focal alveolar infiltrates of foamy macrophages, often containing eosinophilic globular material, and associated with extracellular basophilic fibrillar or eosinophilic globular material. Small numbers of neutrophils were present within alveoli, the interstitium, and bordering vessels.

Several females exposed to 100 ppm vinylidene chloride had minimal to moderate necrosis of the nasal respiratory epithelium and minimal turbinate atrophy (Table 19). Male mice did not develop exposure-related nasal lesions. Respiratory epithelium necrosis occurred on the nasoturbinates and lateral wall of Level I of the nose in all early

death female mice and was characterized by hypereosinophilia and sloughing of cells and debris into the nasal passages. Turbinate atrophy occurred in four 100 ppm females and consisted of blunting and attenuation of scrolls with bone loss and remodeling in Level III of the nose.

*Exposure Concentration Selection Rationale:* Based on mortality, significant reductions in final body weights, and the increased incidences of various nonneoplastic lesions in the 3-month study, vinylidene chloride exposure concentrations selected for the 2-year inhalation study in mice were 6.25, 12.5, and 25 ppm.

## 2-YEAR STUDY

### Survival

Estimates of 2-year survival probabilities for male and female mice are shown in Table 20 and in the Kaplan-Meier survival curves (Figure 6). Survival of 6.25 ppm males was significantly greater than that of the chamber controls. Survival of 25 ppm males and 6.25 and 25 ppm females was significantly less than that of the chamber control groups.

**TABLE 20**  
**Survival of Mice in the 2-Year Inhalation Study of Vinylidene Chloride**

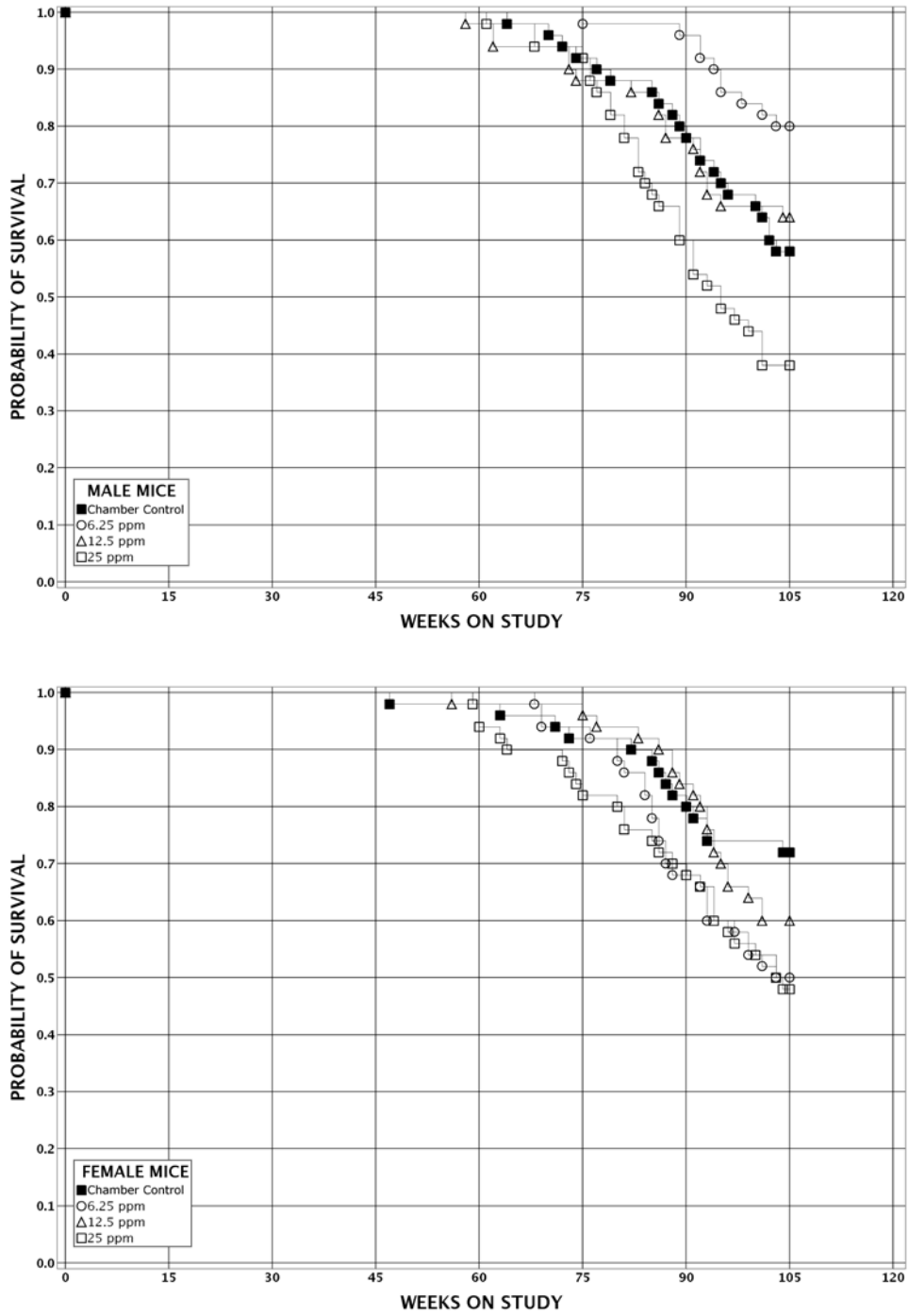
	Chamber Control	6.25 ppm	12.5 ppm	25 ppm
<b>Male</b>				
Animals initially in study	50	50	50	50
Moribund	12	5	14	19
Natural deaths	9	5	4	12
Animals surviving to study termination	29	40 <sup>d</sup>	32	19 <sup>d</sup>
Percent probability of survival at end of study <sup>a</sup>	58	80	64	38
Mean survival (days) <sup>b</sup>	680	713	674	645
Survival analysis <sup>c</sup>	P=0.001	P=0.022N	P=0.791N	P=0.038
<b>Female</b>				
Animals initially in study	50	50	50	50
Moribund	11	20	14	17
Natural deaths	3	5	6	9
Animals surviving to study termination	36	25	30	24 <sup>d</sup>
Percent probability of survival at end of study	72	50	60	48
Mean survival (days)	687	667	688	653
Survival analysis	P=0.064	P=0.046	P=0.399	P=0.027

<sup>a</sup> Kaplan-Meier determinations

<sup>b</sup> Mean of all deaths (uncensored, censored, and terminal kill)

<sup>c</sup> The result of the life table trend test (Tarone, 1975) is in the chamber control column, and the results of the life table pairwise comparisons (Cox, 1972) with the chamber controls are in the exposed group columns. A lower mortality in an exposure group is indicated by N.

<sup>d</sup> Includes one animal that died during the last week of the study



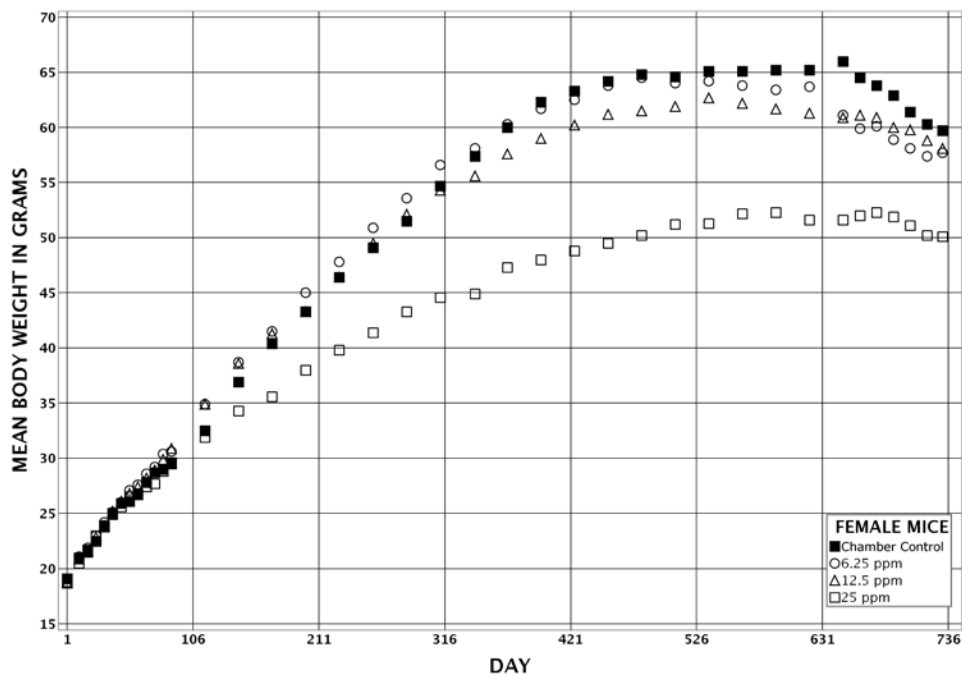
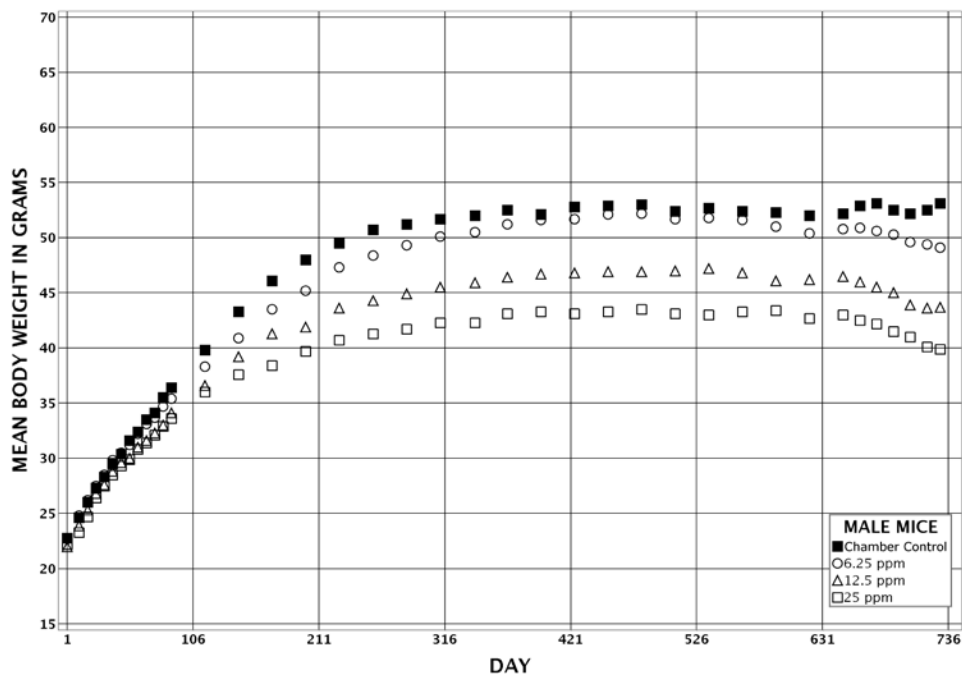
**FIGURE 6**  
**Kaplan-Meier Survival Curves for Mice Exposed to Vinylidene Chloride by Inhalation for 2 Years**

### **Body Weights and Clinical Findings**

Mean body weights of 12.5 and 25 ppm males were at least 10% less than those of the chamber control group after weeks 17 and 13, respectively (Figure 7 and Tables 21 and 22). Mean body weights of 25 ppm females were at least 10% less after week 21, and 20% less for weeks 48 to 93 of the study. Exposure-related clinical findings were observed in 25 ppm males and included thinness and abnormal breathing. Exposure-related clinical findings observed in all exposed groups of females included abnormal breathing, thinness, and torso ventral mass.

### **Gross Findings**

Gross lesions potentially related to vinylidene chloride exposure were observed in the kidney of male mice and ranged from pale, 1 mm cortical foci to large, occasionally bilateral masses that often replaced normal renal parenchyma.



**FIGURE 7**  
**Growth Curves for Mice Exposed to Vinylidene Chloride by Inhalation for 2 Years**

**TABLE 21**  
**Mean Body Weights and Survival of Male Mice in the 2-Year Inhalation Study of Vinylidene Chloride**

Day	Chamber Control		6.25 ppm			12.5 ppm			25 ppm		
	Av. Wt. (g)	No. of Survivors	Av. Wt. (g)	Wt. (% of Controls)	No. of Survivors	Av. Wt. (g)	Wt. (% of Controls)	No. of Survivors	Av. Wt. (g)	Wt. (% of Controls)	No. of Survivors
1	22.8	50	22.7	99	50	22.0	96	50	22.2	97	50
11	24.6	50	24.8	101	50	23.9	97	50	23.3	95	50
18	26.0	50	26.2	101	50	25.3	97	50	24.7	95	50
25	27.3	50	27.5	101	50	26.8	98	50	26.4	97	50
32	28.3	50	28.5	101	50	27.6	97	50	27.5	97	50
39	29.5	50	29.8	101	50	28.8	98	50	28.5	97	50
46	30.4	50	30.5	100	50	29.6	97	50	29.3	96	50
53	31.6	50	31.2	99	50	30.0	95	50	29.9	95	50
60	32.4	50	32.2	99	50	31.0	96	50	30.8	95	50
67	33.5	50	33.1	99	50	31.6	95	50	31.4	94	50
74	34.1	50	33.7	99	50	32.3	95	50	32.1	94	50
81	35.5	50	34.7	98	50	33.0	93	50	32.9	93	50
88	36.4	50	35.4	98	50	34.1	94	50	33.6	93	50
116	39.8	50	38.3	96	50	36.6	92	50	36.0	90	50
144	43.3	50	40.9	94	50	39.2	90	50	37.6	87	50
172	46.1	50	43.5	94	50	41.3	90	50	38.4	83	50
200	48.0	50	45.2	94	50	41.9	87	50	39.7	83	50
228	49.5	50	47.3	96	50	43.6	88	50	40.7	82	50
256	50.7	50	48.4	96	50	44.3	88	50	41.3	82	50
284	51.2	50	49.3	96	50	44.9	88	50	41.7	82	50
312	51.7	50	50.1	97	50	45.5	88	50	42.3	82	50
341	52.0	50	50.5	97	50	45.9	88	50	42.3	81	50
368	52.5	50	51.2	98	50	46.4	88	50	43.1	82	50
396	52.1	50	51.6	99	50	46.7	90	50	43.3	83	50
424	52.8	50	51.7	98	50	46.8	89	49	43.1	82	50
452	52.9	49	52.1	99	50	46.9	89	47	43.3	82	49
480	53.0	49	52.2	99	50	46.9	89	47	43.5	82	47
508	52.4	47	51.7	99	50	47.0	90	46	43.1	82	47
536	52.7	45	51.8	98	49	47.2	89	44	43.0	82	44
564	52.4	44	51.6	99	49	46.8	89	44	43.3	83	39
592	52.3	43	51.0	98	49	46.1	88	43	43.4	83	34
620	52.0	41	50.4	97	48	46.2	89	39	42.7	82	30
648	52.2	37	50.8	97	46	46.5	89	34	43.0	82	26
662	52.9	35	50.9	96	44	46.0	87	33	42.5	81	25
676	53.1	34	50.6	95	43	45.5	86	33	42.2	80	23
690	52.5	34	50.3	96	42	45.0	86	33	41.5	79	23
704	52.2	32	49.6	95	41	43.9	84	33	41.0	79	20
718	52.5	30	49.4	94	40	43.6	83	33	40.1	76	19
<b>Mean for Weeks</b>											
1-13	30.2		30.0	99		28.9	96		28.7	95	
14-52	48.0		45.9	96		42.6	89		40.0	83	
53-103	52.5		51.1	97		46.1	88		42.6	81	



**TABLE 22**  
**Mean Body Weights and Survival Female Mice in the 2-Year Inhalation Study of Vinylidene Chloride**

Day	Chamber Control		6.25 ppm			12.5 ppm			25 ppm		
	Av. Wt. (g)	No. of Survivors	Av. Wt. (g)	Wt. (% of Controls)	No. of Survivors	Av. Wt. (g)	Wt. (% of Controls)	No. of Survivors	Av. Wt. (g)	Wt. (% of Controls)	No. of Survivors
1	19.1	50	19.1	100	50	18.7	98	50	18.8	99	50
11	21.0	50	21.1	101	50	20.9	100	50	20.5	98	50
18	21.7	50	21.9	101	50	21.6	100	50	21.5	99	50
25	22.5	50	23.0	102	50	22.9	102	50	23.0	102	50
32	23.8	50	24.2	102	50	23.9	100	50	23.9	100	50
39	25.0	50	25.1	100	50	25.2	101	50	24.9	99	50
46	25.9	50	26.0	101	50	26.1	101	50	25.6	99	50
53	26.1	50	27.1	104	50	26.8	103	50	26.5	102	50
60	26.7	50	27.6	103	50	27.4	103	50	26.8	100	50
67	27.8	50	28.6	103	50	28.2	101	50	27.4	99	50
74	28.7	50	29.2	102	50	28.9	101	50	27.7	97	50
81	29.0	50	30.4	105	50	29.9	103	50	28.8	99	50
88	29.6	50	30.6	104	50	30.9	105	50	29.5	100	50
116	32.5	50	34.9	107	50	34.9	107	50	31.9	98	50
144	36.9	50	38.7	105	50	38.6	104	50	34.3	93	50
172	40.4	50	41.5	103	50	41.3	102	50	35.6	88	50
200	43.3	50	45.0	104	50	43.3	100	50	38.0	88	50
228	46.4	50	47.8	103	50	46.4	100	50	39.8	86	50
256	49.1	50	50.9	104	50	49.5	101	50	41.4	84	50
284	51.5	50	53.6	104	50	52.1	101	50	43.3	84	50
312	54.7	50	56.6	103	50	54.3	99	50	44.6	82	50
341	57.4	49	58.1	101	50	55.6	97	50	44.9	78	50
368	60.0	49	60.3	101	50	57.6	96	50	47.3	79	50
396	62.3	49	61.7	99	50	59.0	95	49	48.0	77	50
424	63.3	49	62.5	99	50	60.2	95	49	48.8	77	47
452	64.2	48	63.8	100	50	61.2	95	49	49.5	77	45
480	64.8	48	64.5	100	47	61.5	95	49	50.2	77	45
508	64.6	47	64.0	99	47	61.9	96	49	51.2	79	43
536	65.1	46	64.2	99	46	62.7	96	47	51.3	79	41
564	65.1	46	63.8	98	43	62.2	96	47	52.2	80	38
592	65.2	44	63.4	97	39	61.7	95	46	52.3	80	37
620	65.2	41	63.7	98	34	61.3	94	42	51.6	79	35
648	66.0	38	61.1	93	31	60.9	92	38	51.6	78	33
662	64.5	37	59.9	93	30	61.1	95	36	52.0	81	30
676	63.8	37	60.1	94	29	60.9	96	33	52.3	82	28
690	62.9	37	58.9	94	27	60.0	96	32	51.9	83	28
704	61.4	37	58.1	95	27	59.8	97	30	51.1	83	27
718	60.3	37	57.4	95	26	58.8	97	30	50.2	83	26
<b>Mean for Weeks</b>											
1-13	25.1		25.7	102		25.5	101		25.0	99	
14-52	45.8		47.5	104		46.2	101		39.3	86	
53-103	63.7		61.7	97		60.7	95		50.7	80	

## Pathology and Statistical Analyses

This section describes the statistically significant or biologically noteworthy changes in the incidences of hemangioma and hemangiosarcoma and neoplasms and/or nonneoplastic lesions of the kidney, liver, lung, small intestine, nose, mesentery, and uterus. Summaries of the incidences of neoplasms and nonneoplastic lesions, statistical analyses of primary neoplasms that occurred with an incidence of at least 5% in at least one animal group, and historical incidences for the neoplasms mentioned in this section are presented in Appendix C for male mice and Appendix D for female mice.

*Kidney:* Microscopic chemical-related lesions in the kidney of males consisted of renal tubule hyperplasia, renal tubule adenoma, and renal tubule carcinoma. The incidences of adenoma, carcinoma, and adenoma or carcinoma (combined) were significantly increased in all exposed groups of males compared to those in the concurrent chamber control group (Tables 23, C1, and C2). The incidences of adenoma, carcinoma, and adenoma or carcinoma (combined) in exposed groups of males exceeded the historical control ranges for inhalation studies, where none have occurred, and for all routes of administration (Tables 23 and C3). A carcinoma occurred in one 25 ppm female mouse (Table D1), which also exceeded the historical control incidences for inhalation (0/300) and all routes (0/947) of exposure. No adenomas or carcinomas were observed in male or female chamber control mice. Adenomas were most often solitary and unilateral; one incidence of bilateral renal tubule adenoma and three incidences of multiple renal tubule adenoma occurred in 12.5 ppm males. Similar to adenomas, most carcinomas occurred as solitary masses, but the incidences of bilateral carcinoma increased with increasing exposure concentration. In addition, three 12.5 ppm males had multiple carcinomas in one kidney, and four 12.5 ppm males had multiple carcinomas bilaterally.

Renal tubule adenomas were variably sized, well-circumscribed, solitary and discrete, expansile masses composed of fairly well-differentiated neoplastic tubule epithelial cells greater than five tubules in diameter, which compressed the adjacent renal parenchyma. The masses were solid, papillary to cystic, and arranged in tubules, rows, papillae, or sheets composed of tightly packed cuboidal to ovoid, occasionally markedly vacuolated cells overlying a fine fibrovascular stroma (Plate 8). Mitoses were rare or absent. Renal tubule carcinomas shared many of the morphologic features present within adenomas, but were generally larger, more compressive to locally invasive, had

**TABLE 23**  
**Incidences of Neoplasms and Nonneoplastic Lesions of the Kidney in Male Mice**  
**in the 2-Year Inhalation Study of Vinylidene Chloride**

	Chamber Control	6.25 ppm	12.5 ppm	25 ppm
Number Examined Microscopically	50	50	50	50
Renal Tubule, Hyperplasia <sup>a</sup>	0	8** (1.8) <sup>b</sup>	22** (1.7)	16** (1.7)
Cyst	1 (2.0)	1 (2.0)	5 (2.0)	7* (2.6)
Nephropathy	44 (1.9)	46 (1.6)	37* (2.2)	44 (2.2)
Renal Tubule, Adenoma, Single	0	5	15**	10**
Renal Tubule, Adenoma, Bilateral	0	0	1	0
Renal Tubule, Adenoma, Multiple	0	0	3	0
Renal Tubule, Adenoma (includes single, bilateral, and multiple) <sup>c</sup>				
Overall rate <sup>d</sup>	0/50 (0%)	5/50 (10%)	19/50 (38%)	10/50 (20%)
Adjusted rate <sup>e</sup>	0.0%	10.6%	44.2%	26.7%
Terminal rate <sup>f</sup>	0/29 (0%)	5/40 (13%)	15/32 (47%)	8/19 (42%)
First incidence (days)	— <sup>h</sup>	729 (T)	600	525
Poly-3 test <sup>g</sup>	P<0.001	P=0.041	P<0.001	P<0.001
Renal Tubule, Carcinoma, Single	0	6	17**	12**
Renal Tubule, Carcinoma, Bilateral	0	1	7*	6*
Renal Tubule, Carcinoma, Multiple	0	0	3	0
Renal Tubule, Carcinoma, Multiple Bilateral	0	0	4	0
Renal Tubule, Carcinoma (includes single, bilateral, multiple, and multiple bilateral) <sup>i</sup>				
Overall rate	0/50 (0%)	7/50 (14%)	31/50 (62%)	18/50 (36%)
Adjusted rate	0.0%	14.7%	70.5%	45.8%
Terminal rate	0/29 (0%)	5/40 (13%)	24/32 (75%)	10/19 (53%)
First incidence (days)	—	619	429	537
Poly-3 test	P<0.001	P=0.012	P<0.001	P<0.001
Renal Tubule, Adenoma or Carcinoma <sup>j</sup>				
Overall rate	0/50 (0%)	11/50 (22%)	37/50 (74%)	27/50 (54%)
Adjusted rate	0.0%	23.1%	81.9%	67.0%
Terminal rate	0/29 (0%)	9/40 (23%)	27/32 (84%)	17/19 (90%)
First incidence (days)	—	619	429	525
Poly-3 test	P<0.001	P<0.001	P<0.001	P<0.001

\* Significantly different (P≤0.05) from the chamber control group by the Poly-3 test

\*\* P≤0.01

(T) Terminal kill

<sup>a</sup> Number of animals with lesion

<sup>b</sup> Average severity grade of lesions in affected animals: 1=minimal, 2=mild, 3=moderate, 4=marked

<sup>c</sup> Historical incidence for 2-year inhalation studies with chamber control groups (mean ± standard deviation): 0/298; all routes: 8/944 (0.9% ± 1.4%), range 0%-4%

<sup>d</sup> Number of animals with neoplasm per number of animals with kidney examined microscopically

<sup>e</sup> Poly-3 estimated neoplasm incidence after adjustment for intercurrent mortality

<sup>f</sup> Observed incidence at terminal kill

<sup>g</sup> Beneath the chamber control incidence is the P value associated with the trend test. Beneath the exposed group incidence are the P values corresponding to pairwise comparisons between the chamber controls and that exposed group. The Poly-3 test accounts for differential mortality in animals that do not reach terminal kill.

<sup>h</sup> Not applicable; no neoplasms in animal group

<sup>i</sup> Historical incidence for inhalation studies: 0/298; all routes: 3/944 (0.3% ± 1.0%), range 0%-4%

<sup>j</sup> Historical incidence for inhalation studies: 0/298; all routes: 11/944 (1.2% ± 1.8%), range 0%-6%

solid, papillary, cystic, or anaplastic growth patterns, prominent vascular ingrowth, and occasionally large areas of necrosis, hemorrhage, or proteinaceous fluid accumulation, and displayed nuclear and cellular pleomorphism, atypia, and numerous mitoses (Plate 9).

The incidences of renal tubule hyperplasia were significantly increased in all exposed groups of males compared to that in the chamber controls (Tables 23 and C4). Hyperplasia was characterized by enlarged tubules (approximately two to five tubules in diameter) containing increased numbers of epithelial cells with eosinophilic, basophilic, or clear cytoplasm, which exhibited piling and crowding, variable nuclear and cellular pleomorphism, and multilayered or solid growth that partially or completely filled the tubule lumen (Plate 10). The incidence of kidney cyst was significantly increased in 25 ppm males; this lesion also occurred in two females and one female in the 6.25 and 12.5 ppm groups, respectively (Table D4). Kidney cysts were characterized by variably-sized dilations lined by flattened cuboidal epithelial cells which often compressed adjacent renal parenchyma. The incidence of kidney nephropathy was significantly decreased in 12.5 ppm males.

*Liver:* The incidence of hepatocellular adenoma (including multiple) was significantly increased in 12.5 ppm female mice compared to that in concurrent chamber controls and the incidence of hepatocellular carcinoma (including multiple) was significantly increased in 25 ppm females (Tables 24, D1, and D2). When combined, the incidences of hepatocellular adenoma or carcinoma were significantly increased in 12.5 and 25 ppm females. The incidences of hepatocellular adenoma in 12.5 and 25 ppm females and hepatocellular carcinoma and hepatocellular adenoma or carcinoma (combined) in all exposed female groups exceeded the historical control ranges for inhalation studies, but were within the historical control ranges for all routes of administration (Tables 24 and D3).

Hepatocellular adenomas were generally discrete, expansile proliferations of solid sheets of fairly well-differentiated hepatocytes that caused compression of the adjacent hepatic parenchyma. Hepatocellular carcinomas were characterized by large, infiltrative proliferations of solid lobules or trabeculae generally greater than three hepatocytes thick, composed of poorly differentiated hepatocytes effacing the normal lobular architecture of the liver.

**TABLE 24**  
**Incidences of Neoplasms and Nonneoplastic Lesions of the Liver in Mice**  
**in the 2-Year Inhalation Study of Vinylidene Chloride**

	Chamber Control	6.25 ppm	12.5 ppm	25 ppm
<b>Male</b>				
Number Examined Microscopically	50	50	50	50
Basophilic Focus <sup>a</sup>	2	4	2	7*
Hepatocellular Adenoma, Multiple	20	19	17	13
Hepatocellular Adenoma (includes multiple)				
Overall rate <sup>b</sup>	37/50 (74%)	35/50 (70%)	33/50 (66%)	25/50 (50%)
Adjusted rate <sup>c</sup>	77.6%	72.5%	73.8%	60.0%
Terminal rate <sup>d</sup>	21/29 (72%)	31/40 (78%)	25/32 (78%)	12/19 (63%)
First incidence (days)	443	619	429	471
Poly-3 test <sup>e</sup>	P=0.040N	P=0.361N	P=0.422N	P=0.046N
Hepatocellular Carcinoma, Multiple	8	1	4	8
Hepatocellular Carcinoma (includes multiple)				
Overall rate	26/50 (52%)	19/50 (38%)	15/50 (30%)	29/50 (58%)
Adjusted rate	55.0%	38.1%	33.2%	64.4%
Terminal rate	11/29 (38%)	11/40 (28%)	7/32 (22%)	10/19 (53%)
First incidence (days)	443	521	508	425
Poly-3 test	P=0.118	P=0.070N	P=0.026N	P=0.234
Hepatocholangiocarcinoma <sup>f</sup>	1	2	2	3
<b>Female</b>				
Number Examined Microscopically	50	50	50	50
Hepatocellular Adenoma, Multiple	12	9	26*	17
Hepatocellular Adenoma (includes multiple) <sup>g</sup>				
Overall rate	25/50 (50%)	21/50 (42%)	36/50 (72%)	29/50 (58%)
Adjusted rate	55.3%	49.0%	77.6%	69.0%
Terminal rate	20/36 (56%)	13/25 (52%)	25/30 (83%)	19/24 (79%)
First incidence (days)	509	471	524	443
Poly-3 test	P=0.026	P=0.347N	P=0.015	P=0.126
Hepatocellular Carcinoma, Multiple	1	2	2	3
Hepatocellular Carcinoma (includes multiple) <sup>h</sup>				
Overall rate	8/50 (16%)	14/50 (28%)	12/50 (24%)	17/50 (34%)
Adjusted rate	18.2%	32.4%	27.2%	41.3%
Terminal rate	6/36 (17%)	4/25 (16%)	8/30 (27%)	9/24 (38%)
First incidence (days)	611	478	611	415
Poly-3 test	P=0.022	P=0.097	P=0.223	P=0.015

**TABLE 24**  
**Incidences of Neoplasms and Nonneoplastic Lesions of the Liver in Mice**  
**in the 2-Year Inhalation Study of Vinylidene Chloride**

	Chamber Control	6.25 ppm	12.5 ppm	25 ppm
<b>Female</b> (continued)				
Number Examined Microscopically	50	50	50	50
Hepatocellular Adenoma or Carcinoma <sup>a</sup>				
Overall rate	28/50 (56%)	30/50 (60%)	37/50 (74%)	38/50 (76%)
Adjusted rate	61.5%	65.4%	79.3%	84.4%
Terminal rate	22/36 (61%)	14/25 (56%)	25/30 (83%)	21/24 (88%)
First incidence (days)	509	471	524	415
Poly-3 test	P=0.003	P=0.434	P=0.041	P=0.009
Hepatocholangiocarcinoma <sup>j</sup>	0	1	1	2

\* Significantly different ( $P \leq 0.05$ ) from the chamber control group by the Poly-3 test

<sup>a</sup> Number of animals with lesion

<sup>b</sup> Number of animals with neoplasm per number of animals with liver examined microscopically

<sup>c</sup> Poly-3 estimated neoplasm incidence after adjustment for intercurrent mortality

<sup>d</sup> Observed incidence at terminal kill

<sup>e</sup> Beneath the chamber control incidence is the P value associated with the trend test. Beneath the exposed group incidence are the P values corresponding to pairwise comparisons between the chamber controls and that exposed group. The Poly-3 test accounts for differential mortality in animals that do not reach terminal kill. A negative trend or a lower incidence in exposure group is indicated by N.

<sup>f</sup> Historical incidence for 2-year inhalation studies with chamber control groups (mean  $\pm$  standard deviation): 2/299 (0.7%  $\pm$  1.0%), range 0%-2%; all routes: 10/949 (1.1%  $\pm$  2.2%), range 0%-8%

<sup>g</sup> Historical incidence for inhalation studies: 105/300 (35.0%  $\pm$  8.8%), range 28%-50%; all routes: 378/948 (39.9%  $\pm$  18.7%), range 14%-78%

<sup>h</sup> Historical incidence for inhalation studies: 44/300 (14.7%  $\pm$  5.0%), range 10%-20%; all routes: 152/948 (16.0%  $\pm$  10.6%), range 4%-46%

<sup>i</sup> Historical incidence for inhalation studies: 133/300 (44.3%  $\pm$  8.6%), range 32%-56%; all routes: 448/948 (47.3%  $\pm$  19.3%), range 20%-82%

<sup>j</sup> Historical incidence for inhalation studies: 0/300; all routes: 0/948

The incidences of hepatocholangiocarcinoma in exposed groups of males were higher than in the concurrent chamber control groups, and exceeded the historical control range for inhalation studies but not that for all routes of administration (Tables 24, C1, and C2). In females, hepatocholangiocarcinoma occurred in all exposed groups; this neoplasm has not been seen in 300 inhalation controls or 948 controls from all routes of study.

Hepatocholangiocarcinomas were characterized by infiltrative proliferations of trabeculae and solid sheets of poorly differentiated hepatocytes admixed with neoplastic biliary structures that effaced the normal lobular architecture of the liver.

The incidences of hepatocellular adenoma (including multiple) were decreased in males in an exposure concentration-dependent fashion, and the incidences of hepatocellular carcinoma (including multiple) were decreased in 6.25 and 12.5 ppm males (Tables 24, C1, and C2). The incidence of basophilic focus of the liver was significantly increased in 25 ppm males (Tables 24 and C4).

*Hemangioma and Hemangiosarcoma:* The incidences of hemangioma in all exposed groups of females were increased compared to that in the concurrent chamber controls and exceeded the historical control ranges for inhalation studies and all routes of administration (Tables 25 and D1). This neoplasm occurred in the liver, ovary, and uterus of exposed females and in the liver, bone marrow, and testes of exposed males (Tables C1, and D1). Hemangiomas were composed of expansile proliferations of dilated to cavernous vascular spaces lined with well-differentiated endothelial cells. When all organs were combined, the incidence of hemangiosarcoma in 25 ppm females was greater than that in the concurrent chamber controls and exceeded the historical control ranges for inhalation studies and all routes of administration (Tables 25, D1, and D2). Incidences of hemangiosarcoma in female mice were primarily driven by the incidences of this neoplasm in the liver, in which the incidence of hemangiosarcoma in the 25 ppm group was significantly greater than that in the concurrent chamber controls. Hemangiosarcomas occurred in the liver, spleen, mediastinal lymph node, and skeletal muscle of males and females, in the bone marrow, lung, kidney, and thymus of males, and mesentery, ovary, uterus, urinary bladder, and in subcutaneous skin tissues of females. When all organs were combined, the incidence of hemangioma or hemangiosarcoma (combined) in 25 ppm females was significantly greater than that in the concurrent chamber controls. Hemangiosarcomas were composed of infiltrative or invasive proliferations of poorly differentiated endothelial cells forming haphazard vascular channels within multiple organs.

**TABLE 25**  
**Incidences of Hemangioma and Hemangiosarcoma in Female Mice in the 2-Year Inhalation Study of Vinylidene Chloride**

	Chamber Control	6.25 ppm	12.5 ppm	25 ppm
Liver <sup>a</sup>	50	50	50	50
Hemangioma <sup>b</sup>	0	1	0	2
Hemangiosarcoma				
Overall rate <sup>c</sup>	1/50 (2%)	1/50 (2%)	1/50 (2%)	6/50 (12%)
Adjusted rate <sup>d</sup>	2.3%	2.5%	2.3%	15.2%
Terminal rate <sup>e</sup>	1/36 (3%)	1/25 (4%)	1/30 (3%)	3/24 (13%)
First incidence (days)	731 (T)	731 (T)	731 (T)	508
Poly-3 test <sup>f</sup>	P=0.007	P=0.740	P=0.758	P=0.041
All Organs	50	50	50	50
Hemangioma <sup>g</sup>	0	2	2	2
Hemangiosarcoma <sup>h</sup>	4	4	4	9
Hemangioma or Hemangiosarcoma <sup>i</sup>				
Overall rate <sup>j</sup>	4/50 (8%)	6/50 (12%)	6/50 (12%)	11/50 (22%)
Adjusted rate	9.2%	14.9%	13.9%	27.5%
Terminal rate	4/36 (11%)	4/25 (16%)	4/30 (13%)	7/24 (29%)
First incidence (days)	731 (T)	471	620	508
Poly-3 test	P=0.018	P=0.324	P=0.368	P=0.027

(T) Terminal kill

<sup>a</sup> Number of animals with liver examined microscopically or number necropsied

<sup>b</sup> Number of animals with neoplasm

<sup>c</sup> Number of animals with neoplasm per number of animals with liver examined microscopically

<sup>d</sup> Poly-3 estimated neoplasm incidence after adjustment for intercurrent mortality

<sup>e</sup> Observed incidence at terminal kill

<sup>f</sup> Beneath the chamber control incidence is the P value associated with the trend test. Beneath the exposed group incidence are the P values corresponding to pairwise comparisons between the chamber controls and that exposed group. The Poly-3 test accounts for differential mortality in animals that do not reach terminal kill.

<sup>g</sup> Historical incidence for 2-year inhalation studies with chamber control groups (mean ± standard deviation): 0/300; all routes: 5/950 (0.5% ± 0.9%), range 0%-2%

<sup>h</sup> Historical incidence for inhalation studies: 21/300 (7.0% ± 2.1%), range 4%-10%; all routes: 50/950 (5.3% ± 3.9%), range 0%-12%

<sup>i</sup> Historical incidence for inhalation studies: 21/300 (7.0% ± 2.1%), range 4%-10%; all routes: 55/950 (5.8% ± 3.7%), range 2%-14%

<sup>j</sup> Number of animals with neoplasm per number of animals necropsied

*Lung*: The incidence of alveolar/bronchiolar carcinoma (including multiple) in 12.5 ppm females was significantly increased and exceeded the historical control range for inhalation studies (Tables 26, D1, and D2).

Alveolar/bronchiolar carcinomas were characterized by discrete expansile to locally infiltrative irregularly shaped masses composed of solid lobules, papillary projections, and tubular structures composed of fairly well- to poorly differentiated epithelial cells, which effaced the normal alveolar parenchyma.



**TABLE 26**  
**Incidences of Neoplasms and Nonneoplastic Lesions of the Lung in Mice**  
**in the 2-Year Inhalation Study of Vinylidene Chloride**

	Chamber Control	6.25 ppm	12.5 ppm	25 ppm
<b>Male</b>				
Number Examined Microscopically	50	50	50	50
Alveolar Epithelium Hyperplasia <sup>a</sup>	3 (1.3) <sup>b</sup>	7 (1.3)	4 (1.8)	6 (2.3)
<b>Female</b>				
Number Examined Microscopically	50	50	50	49
Alveolar/bronchiolar Adenoma, Multiple	1	0	0	0
Alveolar/bronchiolar Adenoma (includes multiple)	3	4	2	2
Alveolar/bronchiolar Carcinoma, Multiple	0	0	1	0
Alveolar/bronchiolar Carcinoma (includes multiple) <sup>c</sup>				
Overall rate <sup>d</sup>	1/50 (2%)	2/50 (4%)	7/50 (14%)	5/49 (10%)
Adjusted rate <sup>e</sup>	2.3%	4.9%	16.1%	12.7%
Terminal rate <sup>f</sup>	1/36 (3%)	0/25 (0%)	6/30 (20%)	1/24 (4%)
First incidence (days)	731 (T)	558	392	502
Poly-3 test <sup>g</sup>	P=0.038	P=0.477	P=0.030	P=0.080
Alveolar/bronchiolar Adenoma or Carcinoma	4	5	9	7

(T) Terminal kill

<sup>a</sup> Number of animals with lesion

<sup>b</sup> Average severity grade of lesions in affected animals: 1=minimal, 2=mild, 3=moderate, 4=marked

<sup>c</sup> Historical incidence for 2-year inhalation studies with chamber control groups (mean ± standard deviation): 13/299 (4.4% ± 4.3%), range 0%-10%; all routes: 38/949 (4.0% ± 3.6%), range 0%-14%

<sup>d</sup> Number of animals with neoplasm per number of animals with lung examined microscopically

<sup>e</sup> Poly-3 estimated neoplasm incidence after adjustment for intercurrent mortality

<sup>f</sup> Observed incidence at terminal kill

<sup>g</sup> Beneath the chamber control incidence is the P value associated with the trend test. Beneath the exposed group incidence are the P values corresponding to pairwise comparisons between the chamber controls and that exposed group. The Poly-3 test accounts for differential mortality in animals that do not reach terminal kill.

There were slight increases in the incidences of alveolar epithelium hyperplasia in the lung of exposed groups of males (Tables 26 and C4). However, there were no increased incidences of lung neoplasms in any exposed groups of males (Table C1), despite the significantly increased incidence of alveolar/bronchiolar carcinoma in 12.5 ppm females.

*Small Intestine:* Carcinoma of the duodenum occurred in two 25 ppm males (Tables 27 and C1). One carcinoma occurred in the ileum of a 6.25 ppm male. Carcinomas of the duodenum or ileum have not been reported in the six inhalation studies included in the 2013 historical control database. Carcinoma also occurred in the jejunum of two 6.25 ppm males.

**TABLE 27**  
**Incidences of Neoplasms of the Small Intestine in Mice in the 2-Year Inhalation Study of Vinylidene Chloride**

	Chamber Control	6.25 ppm	12.5 ppm	25 ppm
<b>Male</b>				
Duodenum <sup>a</sup>	50	50	50	50
Adenoma	0	0	1	0
Carcinoma <sup>b</sup>	0	0	0	2
Jejunum	50	50	50	50
Carcinoma <sup>c</sup>	0	2	0	0
Ileum	50	50	50	50
Adenoma	1	0	0	0
Carcinoma <sup>d</sup>	0	1	0	0
Small Intestine (Duodenum, Jejunum, or Ileum)	50	50	50	50
Carcinoma <sup>e</sup>	0	3	0	2
Small Intestine (Duodenum, Jejunum, or Ileum): Adenoma or Carcinoma <sup>f</sup>				
Overall rate <sup>g</sup>	1/50 (2%)	3/50 (6%)	1/50 (2%)	2/50 (4%)
Adjusted rate <sup>h</sup>	2.4%	6.4%	2.4%	5.4%
Terminal rate <sup>i</sup>	1/29 (3%)	3/40 (8%)	1/32 (3%)	1/19 (5%)
First incidence (days)	729 (T)	729 (T)	729 (T)	563
Poly-3 test <sup>j</sup>	P=0.463	P=0.348	P=0.758	P=0.455
<b>Female</b>				
Duodenum	50	50	50	50
Adenoma	0	0	1	0
Ileum	50	50	50	50
Adenoma	1	0	0	1
Carcinoma <sup>k</sup>	1	1	1	3
Small Intestine (Duodenum, Jejunum, or Ileum):	50	50	50	50
Small Intestine (Duodenum, Jejunum, or Ileum): Carcinoma				
Overall rate	1/50 (2%)	1/50 (2%)	1/50 (2%)	3/50 (6%)
Adjusted rate	2.3%	2.5%	2.3%	7.8%
Terminal rate	0/30 (0%)	0/25 (0%)	0/30 (0%)	2/24 (8%)
First incidence (days)	599	584	536	640
Poly-3 test	P=0.144	P=0.740	P=0.759	P=0.260

**TABLE 27**  
**Incidences of Neoplasms of the Small Intestine in Mice in the 2-Year Inhalation Study of Vinylidene Chloride**

	Chamber Control	6.25 ppm	12.5 ppm	25 ppm
<b>Female</b> (continued)				
Small Intestine (Duodenum or Ileum): Adenoma or Carcinoma (combined) <sup>m</sup>				
Overall rate	2/50 (4%)	1/50 (2%)	2/50 (4%)	4/50 (8%)
Adjusted rate	4.6%	2.5%	4.6%	10.4%
Terminal rate	1/36 (3%)	0/25 (0%)	1/30 (3%)	3/24 (13%)
First incidence (days)	599	584	536	640
Poly-3 test	P=0.141	P=0.531N	P=0.691	P=0.279

(T) Terminal kill

<sup>a</sup> Number of animals necropsied

<sup>b</sup> Historical incidence for 2-year inhalation studies with chamber control groups (mean ± standard deviation): 0/300; all routes: 1/950 (0.1% ± 0.5%), range 0%-2%

<sup>c</sup> Historical incidence for inhalation studies: 6/300 (2.0% ± 3.4%), range 0%-8%; all routes: 18/950 (1.9% ± 2.2%), range 0%-8%

<sup>d</sup> Historical incidence for inhalation studies: 0/300; all routes: 0/950

<sup>e</sup> Historical incidence for inhalation studies: 6/300 (2.0% ± 3.4%), range 0%-8%; all routes: 19/950 (2.0% ± 2.2%), range 0%-8%

<sup>f</sup> Historical incidence for inhalation studies: 10/300 (3.3% ± 2.7%), range 0%-8%; all routes: 31/950 (3.3% ± 2.3%), range 0%-8%

<sup>g</sup> Number of animals with neoplasm per number of animals necropsied

<sup>h</sup> Poly-3 estimated neoplasm incidence after adjustment for intercurrent mortality

<sup>i</sup> Observed incidence at terminal kill

<sup>j</sup> Beneath the chamber control incidence is the P value associated with the trend test. Beneath the exposed group incidence are the P values corresponding to pairwise comparisons between the chamber controls and that exposed group. The Poly-3 test accounts for differential mortality in animals that do not reach terminal kill. A lower incidence in an exposure group is indicated by N.

<sup>k</sup> Historical incidence for inhalation studies: 2/300 (0.7% ± 1.0%), range 0%-2%; all routes: 2/950 (0.2% ± 0.6%), range 0%-2%

<sup>l</sup> Historical incidence for inhalation studies: 2/300 (0.7% ± 1.0%), range 0%-2%; all routes: 5/950 (0.5% ± 0.9%), range 0%-2%

<sup>m</sup> Historical incidence for inhalation studies (includes jejunum): 4/300 (1.3% ± 1.6%), range 0%-4%; all routes: 10/950 (1.1% ± 1.4%), range 0%-4%

Adenoma occurred in the ileum of a chamber control male and in the duodenum of one 12.5 ppm male. The overall combined incidences of small intestine (duodenum, jejunum, or ileum) carcinoma in males were within the historical control ranges for inhalation studies and all routes of administration (Tables 27, C1, and C2). One adenoma occurred in the duodenum of a 12.5 ppm female, one adenoma and three carcinomas occurred in the ileum of 25 ppm females, and one ileum carcinoma occurred in a 6.25 ppm and a 12.5 ppm female. In 25 ppm females, the incidence of carcinomas of the small intestine (duodenum, jejunum, or ileum) exceeded the historical control ranges for inhalation studies and all routes of administration (Tables 27, D1, and D2). Small intestine adenomas were typically discrete, exophytic masses composed of well-differentiated glandular epithelial cells that did not invade the underlying lamina propria. Carcinomas of the small intestine were characterized by polypoid to sessile proliferations of tubules and acini composed of generally fairly well differentiated epithelium showing local

infiltration into the underlying lamina propria or deeper muscle layers. Carcinomas often exhibited regional or local atypia and pleomorphism, including alterations in architectural pattern and increased mitotic figures.

*Nose:* Exposure-related nonneoplastic lesions occurring in the nose included turbinate atrophy, hyperostosis, olfactory epithelium respiratory metaplasia, and olfactory epithelium hyaline droplet accumulation (Tables 28, C4, and D4). These lesions primarily affected Level III, but often, depending on the lesion, extended into Levels II and/or I in mice exposed to 25 ppm. Turbinate atrophy occurred in the vast majority of male and female mice exposed to vinylidene chloride and the severity of the lesion increased with increasing exposure concentration. Turbinate atrophy was characterized by blunting, attenuation, or loss of turbinates. Incidences of hyperostosis increased in an exposure concentration-related fashion, and occurred in most male and female mice in the 12.5 and 25 ppm groups. Hyperostosis occurred in one chamber control male. This lesion was characterized by extensive bony remodeling of turbinate bones, resulting in misshapen and often thickened, nodular turbinates. Additionally, hyperostosis was often present in the ventral portion of the nasal septum of Level III. Accompanying the septal and turbinate changes were significantly increased incidences of respiratory metaplasia in the olfactory epithelium in all exposed groups of males and females, with exposure concentration-related increases in severities. This lesion was characterized by replacement of the multilayered olfactory epithelium by a single layer of nonciliated or ciliated cuboidal to columnar epithelium. Attenuation of the olfactory epithelium and loss of nerves in the underlying lamina propria often accompanied respiratory metaplasia. The incidences of olfactory epithelium hyaline droplet accumulation were increased in all exposed groups of males and in 25 ppm females; the increases were significant in 12.5 ppm males and 25 ppm males and females. This lesion was characterized by the accumulation of globular, homogeneous, eosinophilic material within the cytoplasm of olfactory epithelial cells.

The incidence of respiratory epithelium hyperplasia was significantly increased in 25 ppm females (Tables 28 and D4). This lesion occurred in Levels I and II of the nose, and was characterized by increased numbers and crowding of respiratory epithelial cells, with folding of the mucosa and extension of infolding into the underlying submucosa (pseudogland formation).

**TABLE 28**  
**Incidences of Nonneoplastic Lesions of the Nose in Mice in the 2-Year Inhalation Study**  
**of Vinylidene Chloride**

	Chamber Control	6.25 ppm	12.5 ppm	25 ppm
<b>Male</b>				
Number Examined Microscopically	50	50	49	49
Turbinate, Atrophy <sup>a</sup>	0	46** (1.1) <sup>b</sup>	46** (2.1)	47** (2.8)
Hyperostosis	1 (2.0)	27** (1.3)	45** (2.1)	48** (2.2)
Olfactory Epithelium, Metaplasia, Respiratory	17 (1.2)	39** (1.2)	47** (1.6)	48** (1.8)
Olfactory Epithelium, Accumulation, Hyaline Droplet	2 (1.0)	5 (1.0)	13** (1.3)	11** (1.3)
<b>Female</b>				
Number Examined Microscopically	50	50	50	50
Turbinate, Atrophy	0	46** (1.0)	50** (2.3)	49** (2.8)
Hyperostosis	0	13** (1.2)	45** (2.0)	48** (2.2)
Olfactory Epithelium, Metaplasia, Respiratory	3 (1.0)	29** (1.1)	49** (1.6)	50** (1.9)
Olfactory Epithelium, Accumulation, Hyaline Droplet	18 (1.6)	18 (1.5)	13 (1.4)	32** (1.8)
Respiratory Epithelium, Hyperplasia	33 (1.1)	41 (1.2)	39 (1.5)	43** (1.8)

\* Significantly different ( $P \leq 0.05$ ) from the chamber control group by the Poly-3 test

\*\*  $P \leq 0.01$

<sup>a</sup> Number of animals with lesion

<sup>b</sup> Average severity grade of lesions in affected animals: 1=minimal, 2=mild, 3=moderate, 4=marked

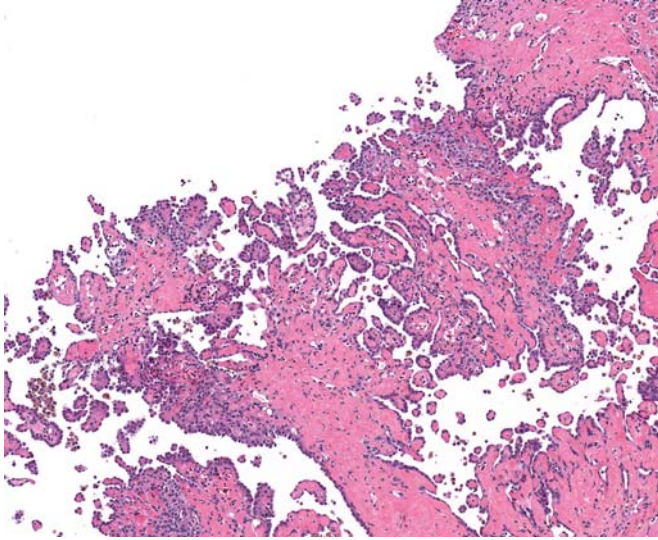
*Other Organs:* Increased incidences of fat necrosis of the mesentery occurred in exposed groups of females (8/10, 14/16, 15/19, 33/37; Table D4). Because this lesion was microscopically examined only in cases in which a gross lesion was observed in the mesenteric fat at the time of necropsy, the true incidence of this lesion is uncertain. There were also treatment- and exposure concentration-related increases in the incidences of fat necrosis in the companion rat study.

Significantly increased incidences of uterus endometrium cystic hyperplasia occurred in all exposed groups of females (36/50, 41/49, 46/50, 46/50; Table D4). Cystic endometrial hyperplasia was characterized by increased numbers of glandular profiles and variably sized cystic structures lined by flattened to cuboidal endometrial epithelium causing dilatation of the uterine lumen and variable compression of the endometrial stroma. This is a

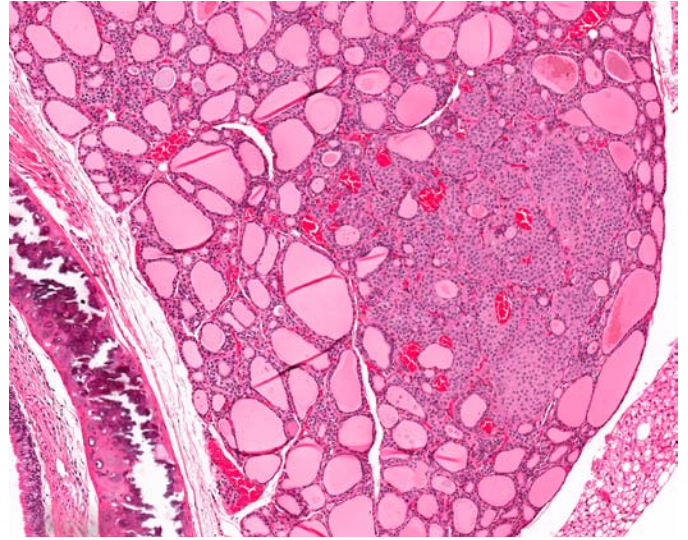
common background lesion in aged mice, and its biologic relevance in this study is uncertain. The incidences of this lesion were not considered to be related to vinylidene chloride exposure.

## GENETIC TOXICOLOGY

Vinylidene chloride tested over a concentration range of 33.3 to 6,666 µg/plate was not mutagenic in *Salmonella typhimurium* strains TA98, TA100, TA1535, or TA1537 when testing occurred with or without exogenous metabolic activation (10% induced hamster or rat liver S9 mix) using a preincubation protocol (Table E1; Mortelmans *et al.*, 1986). However, when tested in a closed system as a vapor, vinylidene chloride (0.16% to 2.5% in air) demonstrated clear mutagenic activity in mouse lymphoma L5178Y *tk*<sup>+/−</sup> cells in trials conducted with 10% induced male rat liver S9 mix (Table E2; McGregor *et al.*, 1991); in the absence of S9, a positive response was seen at a concentration of 30% vinylidene chloride in one of three trials. *In vivo*, no increase in sex-linked recessive lethal mutations was seen in germ cells of adult male *Drosophila melanogaster* exposed via feeding (20,000 or 25,000 ppm) or injection (5,000 ppm) to vinylidene chloride (Table E3; Foureman *et al.*, 1994). No increase in the frequency of micronucleated normochromatic erythrocytes was observed in peripheral blood of male or female B6C3F1/N mice exposed to vinylidene chloride by inhalation for a period of 3 months, and no change in the percentage of immature polychromatic erythrocytes (reticulocytes) was seen in these mice following exposure to vinylidene chloride, suggesting the absence of chemical-induced bone marrow toxicity (Table E4).



**PLATE 1**  
Malignant mesothelioma in a male F344/N rat exposed to 100 ppm vinylidene chloride by whole body inhalation for 2 years. Malignant mesotheliomas were characterized by arboriform proliferations of plump, poorly differentiated mesothelial cells supported by a fibrovascular stroma. H&E



**PLATE 2**  
Thyroid gland C-cell adenoma in a female F344/N rat exposed to 100 ppm vinylidene chloride by whole body inhalation for 2 years. C-cell adenomas were discrete, expansile proliferations of clusters and lobules of fairly well-differentiated C-cells, causing mild compression of adjacent thyroid gland follicular parenchyma. H&E

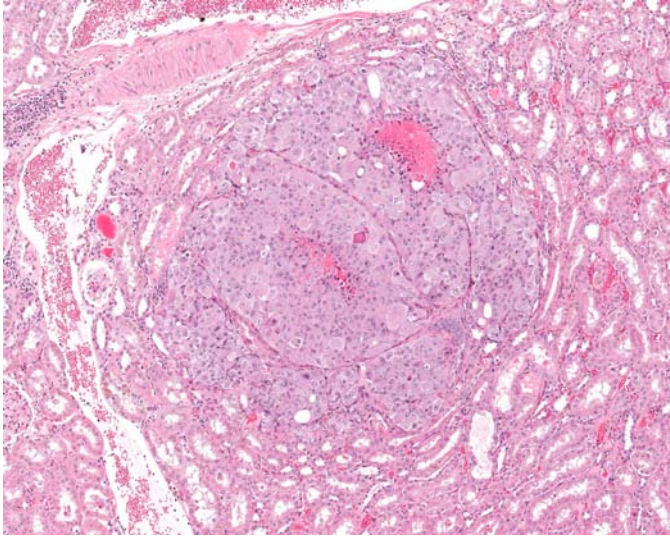


**PLATE 3**  
Thyroid gland C-cell carcinoma in a female F344/N rat exposed to 50 ppm vinylidene chloride by whole body inhalation for 2 years. C-cell carcinomas were large, effaced normal thyroid gland parenchyma, and often invaded adjacent tissues beyond the thyroid capsule. H&E

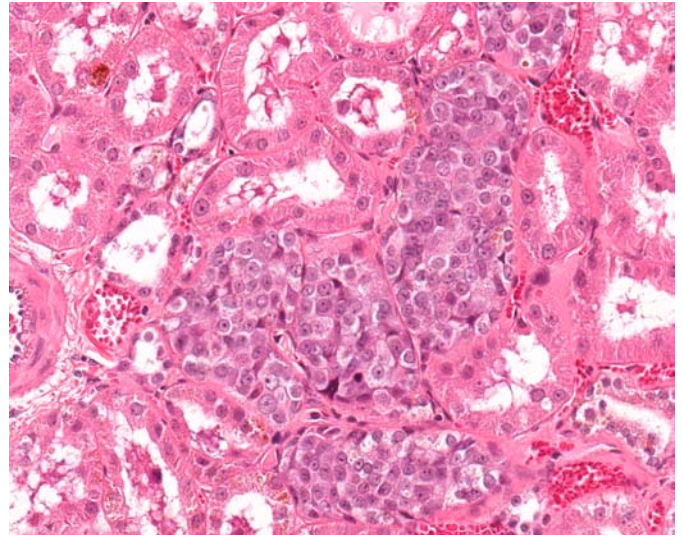


**PLATE 4**  
Renal tubule carcinoma in a male F344/N rat exposed to 100 ppm vinylidene chloride by whole body inhalation for 2 years. Renal tubule carcinomas were invariably large, invasive neoplasms composed of infiltrative clusters and lobules of poorly differentiated renal tubule epithelial cells that effaced and infiltrated normal renal parenchyma, sometimes sparing glomeruli. H&E

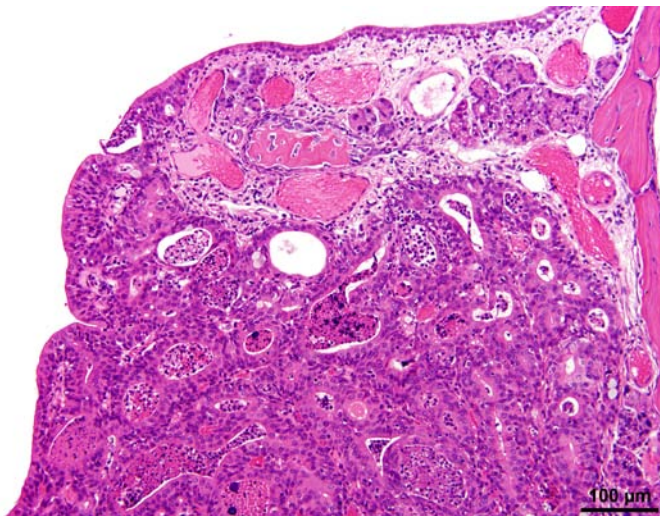




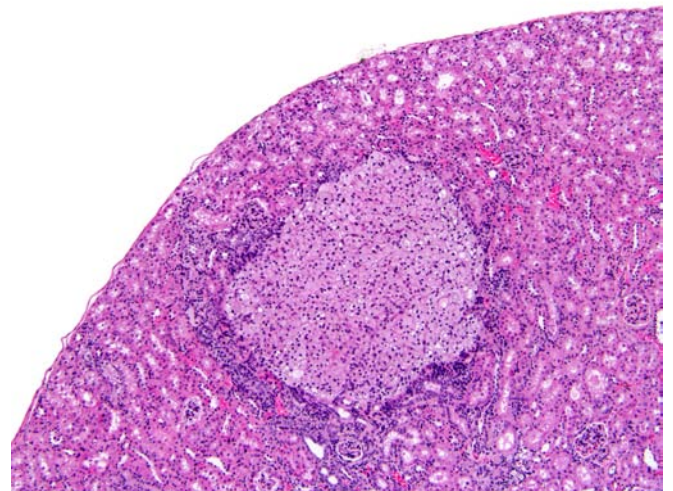
**PLATE 5**  
Renal tubule adenoma in a male F344/N rat exposed to 100 ppm vinylidene chloride by whole body inhalation for 2 years. Renal tubule adenomas were variably sized, expansile masses composed of clusters and lobules of large epithelial cells with variable atypia, causing compression of the adjacent renal parenchyma. H&E



**PLATE 6**  
Renal tubule hyperplasia in a male F344/N rat exposed to 25 ppm vinylidene chloride by whole body inhalation for 2 years. Renal tubule hyperplasias were characterized by piling and filling of one or more tubule lumens with enlarged, well-differentiated epithelial cells. H&E

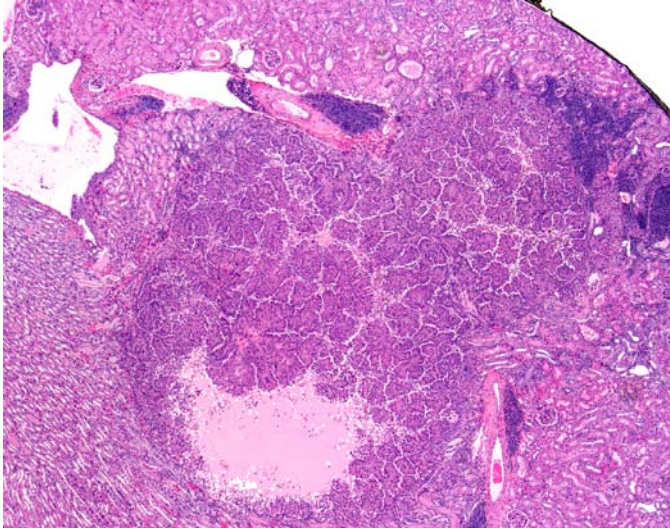


**PLATE 7**  
Nasal adenoma in a male F344/N rat exposed to 100 ppm vinylidene chloride by whole body inhalation for 2 years. The nasal adenoma was expansile, causing partial obstruction of the nasal passage, and was composed of clusters and tubules of fairly well-differentiated nasal epithelial cells supported by a fine fibrovascular stroma. H&E



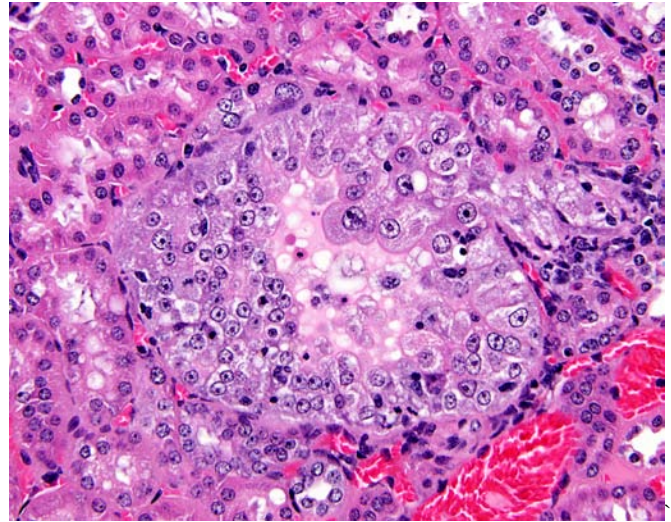
**PLATE 8**  
Renal tubule adenoma in a male B6C3F1/N mouse exposed to 12.5 ppm vinylidene chloride by whole body inhalation for 2 years. Renal tubule adenomas were discrete, expansile lesions that compressed adjacent parenchyma. H&E





**PLATE 9**

Renal tubule carcinoma in a male B6C3F1/N mouse exposed to 12.5 ppm vinylidene chloride by whole body inhalation for 2 years. Renal tubule carcinomas were infiltrative proliferations of tubules, lobules, and papillary projections of poorly differentiated renal tubule epithelial cells that infiltrated and effaced the normal renal architecture, and were often associated with hemorrhage and necrosis. H&E



**PLATE 10**

Renal tubule hyperplasia in a male B6C3F1/N mouse exposed to 6.25 ppm vinylidene chloride by whole body inhalation for 2 years. Renal tubule hyperplasias were discrete lesions characterized by partial to complete filling of one or more tubular lumens by variably pleomorphic epithelial cells exhibiting mild to moderate atypia. H&E

## DISCUSSION AND CONCLUSIONS

Vinylidene chloride was nominated by the Agency for Toxic Substances and Disease Registry (ATSDR), based on insufficient critical information regarding the health effects of vinylidene chloride, as a priority hazardous substance under the Substance Specific Applied Research Program at ATSDR. In previous gavage studies conducted by the NTP (1982), there was no evidence of carcinogenicity in male or female F344/N rats or B6C3F<sub>1</sub> mice. However, because a maximum tolerated dose was not clearly demonstrated and previous studies suggested carcinogenicity associated with inhalation exposure, it was concluded that the studies should not be interpreted that vinylidene chloride is not a carcinogen. Despite a broad database of research from other published studies, adequate data do not exist regarding the carcinogenicity of vinylidene chloride. Although there have been many chronic inhalation and gavage studies reported in the literature, nearly all of these studies are insufficient to accurately evaluate the carcinogenicity of vinylidene chloride. The primary issue with the previously reported studies was that exposure durations were inadequate (12 months or less). However, other issues included changing or discontinuing dosing or exposure concentrations during the study, excessive mortality, inappropriate range of exposures, presence of potential contaminants (vinyl chloride), and lack of statistical description or analysis. The current United States Environmental Protection Agency (USEPA) carcinogen risk assessment is based on increased incidences of adrenal pheochromocytomas that were not statistically significant and thereby not considered treatment related in the previously conducted NTP gavage study (NTP, 1982; Roberts *et al.*, 2002).

The effects of whole-body inhalation exposure to vinylidene chloride for 2 weeks, 3 months, or 2 years were studied in male and female F344/N rats and B6C3F<sub>1</sub>/N mice. Overall, mice were more sensitive to vinylidene chloride-induced toxicity than rats. Species- and strain-specific differences in vinylidene chloride-induced mortality have been widely reported. For the current 2-week study of B6C3F<sub>1</sub>/N mice, exposure concentrations of 50 ppm or greater in males and 100 ppm or greater in females caused decreased survival; in F344/N rats, decreased survival was observed at 200 and 400 ppm. In both rats and mice, the liver and kidney were target organs in early death animals. Early deaths in both sexes of rats and mice were associated with marked centrilobular necrosis in the liver and granular casts in the kidney. In male mice, necrosis was observed in the renal tubules. These hepatic and

nephrotoxic effects associated with mortality occurred quickly after exposure. Kanz *et al.* (1991) demonstrated that, within 12 hours of a single oral administration of 100 mg/kg in Sprague-Dawley rats, vinylidene chloride induced the formation of pyknotic hepatocytes, prenerotic or preapoptotic cells identifiable by the condensation of chromatin in the nucleus. These data suggest that the observed liver effects may be a contributing factor in vinylidene chloride-induced mortality. In 2-week mice, necrosis of the respiratory epithelium in the nose also occurred in all of the early death males and females. In the 3-month study, decreased survival in female mice exposed to 100 ppm was also associated with increased incidences of necrosis in the liver, nose, lung, and larynx.

In the 2-week studies, the liver was a target organ for male and female rats and mice. In rats, liver lesions consisted of centrilobular hepatocellular cytoplasmic alteration in 25, 50, and 100 ppm males and females and centrilobular hepatocellular necrosis in the 200 and 400 ppm groups. The cytoplasmic alteration is suggestive of a degenerative lesion in the lower dose groups that culminates in hepatocellular necrosis at higher doses. In mice, liver lesions consisted of hepatocellular necrosis in males and females exposed to 100, 200, or 400 ppm vinylidene chloride, and there was evidence of hepatocellular regeneration in the 100 ppm female group.

The kidney was also a target organ for male and female rats and male mice in the 2-week studies. In rats, increased kidney weights were observed in both sexes. Kidney lesions consisted of tubule cast formation in the renal papillae in the 200 and 400 ppm males and females. In male mice, lesions were more severe, characterized by not only granular cast formation, but also proximal renal tubule necrosis in all dosed males.

The nose was also a target organ for male and female mice in the 2-week study. Lesions in the nose included respiratory epithelial necrosis in all 100, 200, and 400 ppm males and 200 and 400 ppm females.

In the 3-month studies, no effects on survival or body weights were observed in rats exposed to concentrations of vinylidene chloride up to 100 ppm; in mice, decreased survival was observed in 50 ppm males and 100 ppm females. Final mean body weights in all vinylidene chloride-exposed groups of female mice were significantly less than that of the chamber controls (9% to 18%), and in male mice, there were exposure concentration-dependent decreases (10% to 16%) at 12.5 ppm or greater.

In the 3-month studies, the liver was a target organ in both sexes of rats and in female mice. In male rats, liver lesions consistent with cytoplasmic alteration as observed in the 2-week study occurred at 12.5 ppm or greater, whereas in females, cytoplasmic vacuolization consistent with fatty change was observed at 50 and 100 ppm, suggesting a potential sex-related difference in liver pathology induced by vinylidene chloride. The biologic significance of this difference however, is unknown. In female mice, liver necrosis and centrilobular hypertrophy were observed at 100 ppm. Although mild liver necrosis occurred in two 50 ppm males, this was not statistically significant; however, given the response in females, this may be related to exposure to vinylidene chloride.

Hepatotoxicity was also reflected in mild transient treatment-related increases in sorbitol dehydrogenase and alanine aminotransferase activities. These effects in the liver are consistent with previously reported and well-established vinylidene chloride-induced hepatotoxicity. Various inhalation studies in rodents have demonstrated hepatocellular degeneration, necrosis, and cytoplasmic vacuolization following exposure to vinylidene chloride at concentrations ranging from 15 to 200 ppm (Rampy *et al.*, 1977; Reynolds *et al.*, 1980; NTP, 1982; ATSDR, 2009). In male and female Sprague-Dawley rats exposed to 25 and 75 ppm vinylidene chloride by inhalation for 6 or 12 months, midzonal hepatocellular fatty changes were observed (Quast *et al.*, 1986). Alteration in serum markers of hepatocellular injury, including sorbitol dehydrogenase, alanine aminotransferase, aspartate transaminase, and ornithine carbonyl transferase activities, have also been widely reported following acute inhalation of vinylidene chloride (Jaeger *et al.*, 1975a,b; Jackson and Conolly, 1985) or oral administration (Andersen and Jenkins, 1977; Jenkins and Andersen, 1978; Moslen *et al.*, 1989).

In the nose at 3 months, rats were more sensitive than mice to the treatment-related effects of vinylidene chloride. Increased incidences of atrophy, mineralization, and necrosis of olfactory epithelium were observed in both sexes of rats, whereas only respiratory epithelial necrosis was observed in female mice exposed to 100 ppm. In rats exposed to 6.25 ppm or greater, significant increases in the incidences of olfactory epithelium mineralization in both sexes and of atrophy in males were observed. In males, necrosis of the olfactory epithelium was increased at 12.5 ppm or greater. In females, olfactory epithelium atrophy at 12.5 ppm or greater and olfactory epithelium necrosis at 25 ppm or greater were increased. In general, the severity of these lesions increased with increasing exposure concentration.

In the 3-month studies, nasal turbinate atrophy occurred in all rats exposed to 12.5 ppm or greater, and the severities increased with increasing exposure concentration; whereas, an increased incidence was observed only in 100 ppm female mice. Turbinate atrophy was not observed in any of the chamber controls, 6.25 ppm male or female rats, or at 50 ppm or less in female mice. In the lung of 100 ppm female mice, mild to moderate necrosis of the bronchial epithelium and minimal to mild histiocytic inflammation occurred. In contrast to rats, lesions were observed in the larynx of high dose male and female mice, and in the lung of high dose female mice, which is consistent with involvement of both the upper and lower respiratory tract. Increased incidences of squamous metaplasia of the respiratory epithelium were observed at 50 ppm in both sexes of mice and at 100 ppm in females, and lesion incidences and severities were greater in females than males. Additional lesions of respiratory epithelial hyperplasia and necrosis in the larynx were observed in 100 ppm female mice. These species differences in pulmonary injury are consistent with those reported in male C57BL/6 mice (Forkert *et al.*, 1985), but not in male Sprague-Dawley rats (Chieco *et al.*, 1981) administered a single gavage dose of 200 mg/kg vinylidene chloride. In male C57BL/6 mice, Forkert *et al.* (1985) showed that exposure to vinylidene chloride increased lung weights, induced necrosis and exfoliation of Clara cells in the bronchiolar epithelium, and resulted in peribronchiolar and perivascular edema. This pulmonary injury in mice was transient, and a regenerative response was observed 3 days after exposure, with the integrity of the epithelium substantially restored by 7 days. While neither of these studies included females for evaluation, these data are consistent with species-specific sensitivity between rats and mice.

In the current 3-month studies, the kidney was a target organ in male mice, but not rats or female mice. Increased incidences of minimal to moderate nephropathy were observed in male mice at 12.5 ppm or greater with exposure concentration-dependent increases in the severities. In addition, two 50 ppm males had proximal renal tubule necrosis and cast formation, consistent with the kidney findings in the 2-week study. While the incidences of necrosis and cast formation were not statistically significant, they were considered to be related to exposure to vinylidene chloride. In rats, dose-dependent increases (8% to 16%) in kidney weights were observed in females exposed to 12.5 ppm or greater; however, no corresponding changes in histopathology were observed. In the previous NTP (1982) gavage studies, chronic renal inflammation was observed in both sexes of F344/N rats exposed to 5 mg/kg following 2 years of exposure.

Corresponding to the nephropathy, there were mild exposure concentration-dependent decreases in the erythrocyte counts, hemoglobin concentration, and hematocrit values of the 12.5 ppm and greater male mice in the 3-month study. These decreases may be related to the decreases in body weight as well as the nephropathy, as the kidneys are the primary source of erythropoietin production. Specifically, erythropoietin is produced by interstitial peritubular cells within interstitial foci mostly adjacent to the proximal convoluted tubules (Krantz, 1991). Injury to these areas of the kidney, like that observed in this study, can lead to decreased production of erythropoietin with a subsequent decrease in erythropoiesis and total red blood cell mass. In addition, reductions in erythropoiesis with renal injury are also attributed to the effects of uremic toxins (Hall and Everds, 2008).

The observed species differences in the current 2-week and 3-month studies are consistent with previous reports that mice are more susceptible than rats to vinylidene chloride-induced nephrotoxicity. In male CD-1 mice, kidney nephrosis was observed within 24 hours of inhalation exposure to 50 ppm (Reitz *et al.*, 1980). Moderate-to-severe nephrosis was also observed in four strains of mice exposed to 55, 100, or 200 ppm 6 hours/day, 5 days per week for 10 days (ATSDR, 2009). Nephrotoxicity has also been observed in rats, but at higher exposure concentrations. In male Sprague-Dawley rats, exposure to greater than 300 ppm vinylidene chloride induced tubular necrosis with calcium deposits (Jackson and Conolly, 1985). At 250 ppm, vinylidene chloride induced moderate cellular swelling in the renal cortex. In fasted males, which are more sensitive to the toxicity of vinylidene chloride, marked degeneration of proximal tubular epithelium was observed at 200 ppm (McKenna *et al.*, 1978b). In male and female Sprague-Dawley rats fasted overnight, oral administration of a single gavage dose of 400 mg/kg vinylidene chloride increased serum markers of renal toxicity and induced dose-related histopathologic changes in the kidney, including vacuolization, pigmentation, tubular dilation, and necrosis (Jenkins and Andersen, 1978).

In the 2-year study in rats, increased incidences of neoplasms were observed in the nose and kidney of males and in the thyroid gland of females exposed to vinylidene chloride. Increased incidences of systemic neoplasms were also observed in both sexes. In males, vinylidene chloride induced marked increases in the incidences of malignant mesothelioma in all exposed groups with a concentration-dependent decrease in the time to first incidence. These neoplasms were associated with gross observations of fluid in the abdomen and multiple nodules throughout the peritoneum, particularly on the testicular tunics and epididymides, but also involved a variety of abdominal organs

including the intestines, mesentery, pancreas, prostate gland, spleen, and liver. One 25 ppm male had mesothelioma within the pleura and pericardium in addition to the testicular and epididymal sites. In addition, mesotheliomas were observed in the thoracic cavity of one 25 ppm and the abdominal cavity of one 50 ppm female. Malignant mesothelioma is an uncommon background neoplasm in male F344/N rats, most often arising from the testicular tunics. This neoplasm is very rare in female rats. Therefore, the vinylidene chloride-induced increase in the incidences of malignant mesothelioma in male rats was considered clear evidence for carcinogenicity. The malignant mesotheliomas observed in two female rats may have been related to vinylidene chloride exposure.

Compared to spontaneous mesotheliomas in control animals, mesotheliomas arising in vinylidene chloride-exposed animals had overrepresentation of pathways associated with a proinflammatory response and immune dysregulation. These global gene changes allowed separation of background spontaneous mesotheliomas from those arising in vinylidene chloride-exposed animals based on genomic signatures, despite indistinguishable morphology between these neoplasm groups.

A molecular phenotype consistent with a proinflammatory response, immune dysregulation, or tissue damage has been shown to be associated with mechanisms of tumorigenesis, including development of mesothelioma. Inflammation is a well known contributor to mesotheliomagenesis (Hanahan and Weinberg, 2000, 2011; Colotta *et al.*, 2009). Exposure to vinylidene chloride results in saturation of the glutathione pathway and the generation of reactive vinylidene chloride metabolites (1,1-diethylene oxide, chloroacetyl chloride), which have the potential to cause tissue damage (Hathway, 1977). Although there was not a significant inflammatory response observed in either spontaneous or vinylidene chloride-treated mesotheliomas nor a significant difference in necrosis, apoptosis, or tissue damage between the tumor groups, molecular features suggest a proinflammatory microenvironment. Anti-inflammatory cytokines and chemokines were underrepresented in vinylidene chloride-exposed mesotheliomas compared to spontaneous tumors, while pattern recognition receptors and damage-associated molecular pattern molecules were upregulated, consistent with immune dysregulation and a proinflammatory response. Responses such as these have been associated with mesothelial cell proliferation (Mutsaers *et al.*, 1997). The overrepresentation of these complex pathways supports the observation of a proinflammatory environment associated with mesotheliomas in vinylidene chloride-exposed animals.

In female rats, the incidence of mononuclear cell leukemia in the 100 ppm group was significantly increased, and the time to first incidence was markedly shorter (by 236 days) than in the chamber controls. The time to first incidence was also decreased in the 25 and 50 ppm groups; however, the incidences in these groups were comparable to the chamber control incidence. Mononuclear cell leukemia is a relatively common background neoplasm in F344/N rats, but there was a significant increase in the 100 ppm females that exceeded the historical control ranges for studies by inhalation exposure and all routes combined. There was also an exposure-dependent decrease in the time to first incidence of the neoplasms. Therefore, the increased incidence of mononuclear cell leukemia in females exposed to 100 ppm was considered to be related to vinylidene chloride exposure. Cotti *et al.* (1988) also reported increased incidences of leukemia in male and female Sprague-Dawley rats exposed to 100 ppm vinylidene chloride *in utero* starting on gestation day 12 for a duration of 104 weeks. These leukemias were described as a variety of hemolymphoreticular neoplastic diseases at different sites. In the NTP (1982) gavage study, increased incidences of lymphoma or leukemia were observed at 1 mg/kg but not at 5 mg/kg. These lesions were not considered related to vinylidene chloride exposure.

In the thyroid gland, C-cell adenomas were increased in the 100 ppm female rats and occurred with a positive exposure concentration-dependent trend. C-cell carcinomas were observed in all groups of exposed females with a significant increased incidence occurring at 25 ppm, but not at 50 or 100 ppm. C-cell carcinomas are rare neoplasms in the F344/N rat. The incidences at 50 and 100 ppm, while not statistically significant, exceeded the historical control range for the inhalation route of exposure in female rats. The combined incidences of adenoma or carcinoma were increased in all exposed female groups compared to controls, with significant increases observed at 25 and 100 ppm. However, there was no accompanying increase in the incidences of hyperplasia, and the increases were not exposure concentration-dependent. Exposure to vinylidene chloride did not induce C-cell neoplasms in males. The increases in C-cell neoplasms in female rats were considered to be related to vinylidene chloride exposure. These findings were considered some evidence of carcinogenic activity.

In the kidney, renal tubule carcinomas were observed in male rats exposed to vinylidene chloride for 2 years. While the incidences were not statistically significant, these neoplasms are exceedingly rare in male F344/N rats and have not been observed in 200 historical controls from inhalation studies. Furthermore, after single and step section



evaluations were combined, a dose-related increase in the incidences of renal tubule hyperplasia were observed in exposed male rats; this lesion may be considered a precursor to neoplasm formation. In addition, there was a robust kidney neoplasm response in vinylidene chloride exposed male mice in the corresponding mouse study, further supporting the kidney as a target of carcinogenesis in rats.

As observed in the 3-month study, the nose was a target organ for toxicity in the 2-year study in rats. In males, there was a positive trend in the incidences of adenoma of the respiratory epithelium. While the incidences of this neoplasm were low, no nasal adenomas were observed in any of the 697 historical controls from studies with all routes of exposure in F344/N rats. In addition, nonneoplastic lesions occurred in both sexes with increased incidences and severities with increasing exposure concentration. These lesions included turbinate atrophy and hyperostosis, respiratory metaplasia of olfactory epithelium, chronic active inflammation, respiratory epithelial hyperplasia, and thrombosis. These nonneoplastic lesions are consistent with chronic injury and repair, a process that has been linked with carcinogenesis; therefore, the nasal adenomas in males were considered to be related to exposure to vinylidene chloride. In the lower respiratory tract, there was an increased incidence of alveolar epithelium hyperplasia in all exposed male groups with an exposure concentration-dependent increase in severity. However, no neoplasms were observed in the lung, indicating that the nose was the primary target of vinylidene chloride exposure.

The liver was a target organ for toxicity in 2-year rats, but exposure to vinylidene chloride did not induce any treatment-related hepatic neoplasms. Vinylidene chloride induced chronic inflammation and diffuse fatty change in both sexes at all exposure concentrations. Necrosis and cystic degeneration were also observed at higher exposure concentrations.

Nonneoplastic lesions observed at increased incidences included ovarian bursal dilatation and mesenteric fat necrosis. The incidences of bursal dilatation of the ovary were significantly increased in an exposure concentration-related manner, and the severities were increased in the exposed groups. The etiology of bursal dilatation may involve obstruction of the oviduct or other lower reproductive tract structures due to chronic inflammation or other abnormality; however, no such predisposing factor was noted grossly or on histopathologic examination. As such,

the cause of increase in the incidences of ovarian bursal dilatation remains uncertain, and its biologic significance in this study is unknown. Increased incidences of fat necrosis of the mesentery were observed in all groups of exposed female rats. Localized fat necrosis may occur secondary to peritonitis or inflammatory lesions in the liver and other organs; however, this needs to be further substantiated, as the definitive cause of this lesion could not be determined, and, thus, its biologic relevance is uncertain. There are also treatment- and exposure concentration-related increases in the companion mouse study, which suggest a similar effect across species. However, because histopathologic examination of this lesion was only performed when gross lesions in the mesenteric fat were observed, this true incidence and biologic relevance of this lesion remains unknown.

The current 2-year rat study demonstrates that vinylidene chloride induced malignant mesotheliomas, renal tubule carcinomas, and nasal respiratory epithelium adenomas in males, and mononuclear cell leukemia and thyroid gland C-cell adenomas and carcinomas in females. Previously reported carcinogenicity studies with vinylidene chloride in rats failed to demonstrate carcinogenicity in a variety of rat strains, including Wistar, Sprague-Dawley, and CD rats. In these studies, no treatment-related tumors were reported following exposure to vinylidene chloride by inhalation (Viola and Caputo, 1977; Maltoni *et al.*, 1977, 1985; Lee *et al.*, 1978; Quast *et al.*, 1986; Cotti *et al.*, 1988) or by oral administration (Maltoni *et al.*, 1977, 1985; Ponomarkov and Tomatis, 1980). With the exception of two studies (Ponomarkov and Tomatis, 1980; Quast *et al.*, 1986), rats in these studies were only exposed for 1 year, an exposure period that is too short to adequately determine carcinogenicity. In the studies conducted by Quast *et al.* (1986), inhalation exposures up to 75 ppm vinylidene chloride were carried out for 18 months in Sprague-Dawley rats followed by a 6-month recovery period. Ponomarkov and Tomatis (1980) exposed pregnant female BD IV rats to 150 mg/kg vinylidene chloride by gavage on gestation day 17 and exposed the offspring once weekly at 50 mg/kg for up to 120 weeks. No exposure-related tumors were observed in the studies conducted by Ponomarkov and Tomatis (1980) or Quast *et al.* (1986).

In the 2-year mouse study, decreases in body weight occurred in males at 12.5 and 25 ppm and females at 25 ppm. Decreased survival was observed at 25 ppm in males and in 6.25 and 25 ppm females. Increased survival was observed in 6.25 ppm males. Similar to the 3-month study, the kidney, liver, and nose were target organs.

Following exposure to vinylidene chloride for 2 years, treatment-related neoplasms were observed in the kidney of males, in the liver of males and females, and in the lung and small intestine and systemically in females.

In all exposed groups of males, there were significant increases in the incidences of renal tubule hyperplasia, adenoma, and carcinoma. Additionally, bilateral and multiple adenomas and carcinomas were observed in some animals at 12.5 ppm. Grossly observed neoplastic lesions ranged from 1 mm pale cortical foci to large, occasionally bilateral masses that often replaced normal parenchyma. No renal tubule hyperplasia, adenomas, or carcinomas were observed in chamber control male mice or in 298 historical control mice from inhalation studies. In addition, one renal tubule carcinoma occurred in a 25 ppm female mouse; this is an exceedingly rare neoplasm in female mice. Based on the marked treatment-related increase in the incidences of renal tubule adenoma and carcinoma and concurrent increases in the incidences of renal tubule hyperplasia, renal cell adenoma and carcinoma were considered to be related to vinylidene chloride exposure.

The mechanism by which vinylidene chloride induces adverse effects in the liver and kidney may be related to the deactivation in the liver and reactivation in the kidney. Vinylidene chloride is metabolized in the liver by CYP2E1 and undergoes subsequent conjugation by glutathione or cysteine and is then transported to the kidney for excretion. This metabolic pathway is similar to that of trichloroethylene, a structurally similar chemical that also yields glutathione- and cysteine-conjugated metabolites. For trichloroethylene, glutathione conjugation leads to the formation of *S*-(1,2-dichlorovinyl)glutathione (DCVG), which can be further metabolized to the cysteine conjugate, *S*-(1,2-dichlorovinyl)-L-cysteine (DCVC) (Lash *et al.*, 1988, 2000). Exposure to DCVC has been associated with nephrotoxicity and is believed to be associated with nephrocarcinogenicity (Elfarra and Anders, 1984; Elfarra *et al.*, 1986; Lash *et al.*, 2000). The mechanism for kidney effects has been associated with cysteine conjugate  $\beta$ -lyase activity in the kidney.  $\beta$ -lyase bioactivation of DCVC to *S*-(1,2-dichlorovinyl)thiol (DCVSH), a chemically unstable compound that undergoes rearrangement to reactive species that alkylate cellular nucleophiles, is considered to be the major metabolic pathway of DCVC (Dekant *et al.*, 1988; Lash *et al.*, 2000). According to this proposed metabolic pathway, vinylidene chloride may undergo metabolism by hepatic cytochrome P450 and conjugation to deactivated products that are transported to the kidney. In the kidney, cysteine-conjugated products become ideal substrates for  $\beta$ -lyase bioactivation to reactive metabolites. Eyre *et al.* (1995a,b) found that the

activation of trichloroethylene by  $\beta$ -lyase was greater in mice than in rats, which is consistent with the more potent responses observed in the mice than the rats.

In the liver of female mice, there were positive trends in the incidences of hepatocellular adenoma, carcinoma, and adenoma or carcinoma (combined); the combined incidences were significantly increased at 12.5 and 25 ppm. The incidence of hepatocellular carcinoma was significantly increased in the 25 ppm females compared to controls. The increased incidences of these neoplasms may have been related to exposure to vinylidene chloride; however, these neoplasms are common background neoplasms in B6C3F1 mice with a wide range in incidence. Furthermore, there is not a corresponding hepatocellular adenoma or carcinoma response in male mice. Hepatocholangiocarcinomas were observed in one 6.25 ppm, one 12.5 ppm, and one 25 ppm female, while none were observed in chamber controls or in any of the 948 historical controls by all route of exposure, which includes 300 from inhalation studies. Therefore, these neoplasms were considered to also be related to vinylidene chloride exposure.

In male mice, a single hepatocholangiocarcinoma was observed in chamber controls, two each in the 6.25 ppm and 12.5 ppm dose groups, and three in the 25 ppm group. These neoplasms are not as rare in males, with 10 observed in 949 historical controls by all routes of exposure, including 2 of 299 from inhalation studies. Additionally, the incidences did not exceed the historical controls for all routes of exposure. The hepatocholangiocarcinomas in males may have been related to vinylidene exposure. In males, there was an exposure concentration-dependent decreasing trend in the incidence of hepatocellular adenoma, and significant decreases in the incidence of adenoma at 25 ppm and carcinoma at 12.5 ppm. The incidence of basophilic focus was significantly increased in 25 ppm males. The biological significance of these lesions is unclear.

In 25 ppm female mice, there was an increase in the incidence of systemic hemangiosarcoma, predominantly driven by the statistically significant increase in the incidence of this neoplasm in the liver. Systemic hemangiomas were also observed in two females in each exposed group. None were observed in the control group, or in any of the 300 historical controls from inhalation studies. The incidences also exceeded the historical control range for all routes of exposure. Based on the increased incidence of hemangioma or hemangiosarcoma (combined) for all

organs, which occurred with a positive trend among exposure groups and was significantly increased in the 25 ppm group, these neoplasms were considered related to vinylidene chloride exposure.

The incidence of alveolar/bronchiolar carcinoma in 12.5 ppm female mice was significantly increased compared to chamber controls, and the incidence in the 25 ppm females was at the upper end of the the historical control range for inhalation studies. Additionally, a positive trend was observed. The time to first incidence for alveolar/bronchiolar carcinoma was decreased in all exposed groups of females. It was shortened as many as 339 days in the 12.5 ppm females. While there was a positive trend and significant pairwise comparison compared to chamber controls, there was no supporting increase in the incidences of alveolar/bronchiolar adenoma, no neoplastic effect in males, and no accompanying increase in incidence or severity of hyperplastic lesions.

Alveolar/bronchiolar carcinomas are also fairly common background neoplasms. Given these data, and the fact that this was an inhalation route of exposure, it was considered that the incidence of alveolar/bronchiolar carcinoma in female mice may have been related to vinylidene chloride treatment. The induction of pulmonary adenomas by vinylidene chloride was previously reported in both male and female Swiss mice, with increased incidences in males at 10 ppm and both sexes at 25 ppm (Maltoni *et al.*, 1977, 1985). Lee *et al.* (1978) also report increased incidences of alveolar/bronchiolar adenomas in male CD-1 mice. These increases were not statistically significant, however exposures in this study were only conducted for 1 year, not 2 years as in the current study.

A few uncommon carcinomas of the small intestine occurred in both male and female mice. The incidences in males fell within the historical control ranges, but the incidence in the 25 ppm group of females was outside the historical control ranges both for inhalation studies and all routes of exposure. Therefore, the incidence of small intestine neoplasms in female mice may have been related to vinylidene chloride exposure.

Similar to the effects observed in rats, nonneoplastic lesions were observed in the nose of male and female mice with generally increased incidence and severity with increasing exposure concentration. Significantly increased incidences of atrophy of the turbinate, hyperstosis, and respiratory metaplasia in the olfactory epithelium were observed in all exposed groups. In females, the incidences of hyaline droplet accumulation in the olfactory

epithelium and respiratory epithelium hyperplasia were increased at 25 ppm. In males, the incidences of hyaline droplet accumulation in the olfactory epithelium was increased at 12.5 and 25 ppm.

Treatment-related increases in other nonneoplastic lesions were observed in female mice. There were increased incidences of fat necrosis of the mesentery in exposed groups of female mice, similar to what was observed in the companion rat study; however, because this lesion was only examined microscopically when a gross lesion in the mesentery was observed at necropsy, the true incidence of this lesion is uncertain. Localized fat necrosis may occur with inflammatory lesions in the liver or other closely associated abdominal organs; however, this needs to be further substantiated, and the true biologic significance of this lesion remains uncertain. Cystic endometrial hyperplasia of the uterus was significantly increased in incidence in exposed groups of female mice. However, the cause of this increase could not be determined based on histopathologic examination, and therefore the biologic relevance between this increased incidence and vinylidene chloride exposure remains unknown.

The results from a variety of genetic toxicology studies, including approaches such as bacterial mutagenicity assays, yeast test systems, mammalian cell lines, and *in vivo* tests indicate that vinylidene chloride has mutagenic, clastogenic, and aneugenic properties. How vinylidene chloride exerts these effects is relatively unknown; however, one study suggested that vinylidene chloride alkylates DNA in tissues that are associated with vinylidene chloride-induced tumorigenesis (liver and kidney), although the alkylation occurred at low levels (Reitz *et al.*, 1980). Considering that it is well-known that alkylating agents in general possess mutagenic, clastogenic, and aneugenic properties, are known carcinogens and have long been used for chemotherapeutic purposes (Fu *et al.*, 2012), it may be possible that vinylidene chloride is a weak initiator of tumorigenesis via alkylation of DNA.

## CONCLUSIONS

Under the conditions of this 2-year inhalation study, there was *clear evidence of carcinogenic activity\** of vinylidene chloride in male F344/N rats based on increased incidences of malignant mesothelioma. Increased incidences of renal tubule carcinoma and respiratory epithelium adenoma in the nose of male rats were also considered to be related to vinylidene chloride exposure. There was *some evidence of carcinogenic activity* of vinylidene chloride in female F344/N rats based on increased incidences of C-cell adenoma or carcinoma in the thyroid gland and systemic

mononuclear cell leukemia. Occurrences of malignant mesothelioma may have been related to vinylidene chloride exposure. There was *clear evidence of carcinogenic activity* of vinylidene chloride in male B6C3F1/N mice based on increased incidences of renal tubule adenoma and carcinoma. Increased incidences of hepatocholangiocarcinoma may have been related to vinylidene chloride exposure. There was *clear evidence of carcinogenic activity* of vinylidene chloride in female B6C3F1/N mice based on increased incidences systemic hemangioma or hemangiosarcoma (combined). Hepatocholangiocarcinoma and hepatocellular adenoma and carcinoma (combined) in the liver of female mice were also considered to be related to vinylidene chloride exposure. Increased incidences of alveolar/bronchiolar carcinoma in the lungs and carcinoma of the small intestine may have been related to treatment.

Exposure to vinylidene chloride caused increases in the incidences of nonneoplastic lesions in the nose of rats and mice, the liver of rats, the lung of male rats, and the kidney of male mice.

---

\* Explanation of Levels of Evidence of Carcinogenic Activity is on page 17.

## REFERENCES

Agency for Toxic Substances and Disease Registry (ATSDR) (1994). Toxicological Profile for 1,1-Dichloroethene. U.S. Department of Health and Human Services, Public Health Service, Agency for Toxic Substances and Disease Registry.

Agency for Toxic Substances and Disease Registry (ATSDR) (2009). Toxicological Profile for 1,1-Dichloroethene. U.S. Department of Health and Human Services, Public Health Service, Agency for Toxic Substances and Disease Registry.

*The Aldrich Library <sup>13</sup>C and <sup>1</sup>H FT-NMR Spectra* (1993). 1st ed., Vol. 1, p. 142. Aldrich Chemical Company, Inc., Milwaukee, WI.

*The Aldrich Library of FT-IR Spectra* (1997). 2nd ed. (C.J. Pouchert, Ed.), Vol. 2, p. 140 (D). Aldrich Chemical Company, Inc., Milwaukee, WI.

American Conference of Governmental Industrial Hygienists (ACGIH) (2013). *TLVs and BEIs. Threshold Limit Values for Chemical Substances and Physical Agents and Biological Exposure Indices*, p. 60. Cincinnati, OH.

Andersen, M.E., and Jenkins, L.J., Jr. (1977). Oral toxicity of 1,1-dichloroethylene in the rat: Effects of sex, age, and fasting. *Environ. Health Perspect.* **21**, 157-163.

Andersen, M.E., Jones, R.A., and Jenkins, L.J., Jr. (1978). The acute toxicity of single, oral doses of 1,1-dichloroethylene in the fasted, male rat: Effect of induction and inhibition of microsomal enzyme activities on mortality. *Toxicol. Appl. Pharmacol.* **46**, 227-234.

Andersen, M.E., French J.E., Gargas, M.L., Jones, R.A., and Jenkins, L.J., Jr. (1979). Saturable metabolism and the acute toxicity of 1,1-dichloroethylene. *Toxicol. Appl. Pharmacol.* **47**, 385-393.

Andersen, M.E., Thomas O.E., Gargas, M.L., Jones, R.A., and Jenkins, L.J., Jr. (1980). The significance of multiple detoxification pathways for reactive metabolites in the toxicity of 1,1-dichloroethylene. *Toxicol. Appl. Pharmacol.* **52**, 422-432.

Anderson, D., Hodge, M.C., and Purchase, I.F. (1977). Dominant lethal studies with the halogenated olefins vinyl chloride and vinylidene dichloride in male CD-1 mice. *Environ. Health Perspect.* **21**, 71-78.

Ashby, J., and Tennant, R.W. (1991). Definitive relationships among chemical structure, carcinogenicity and mutagenicity for 301 chemicals tested by the U.S. NTP. *Mutat. Res.* **257**, 229-306.

Baden, J.M., Kelley, M., Simmon, V.F., Rice, S.A., and Mazze, R.I. (1978). Fluorene mutagenicity. *Mutat. Res.* **58**, 183-191.

Bailer, A.J., and Portier, C.J. (1988). Effects of treatment-induced mortality and tumor-induced mortality on tests for carcinogenicity in small samples. *Biometrics* **44**, 417-431.

Ban, M., Hettich, D., Huguet, N., and Cavelier, L. (1995). Nephrotoxicity mechanism of 1,1-dichloroethylene in mice. *Toxicol. Lett.* **78**, 87-92.

Bartsch, H., Malaveille, C., Montesano, R., and Tomatis, L. (1975). Tissue-mediated mutagenicity of vinylidene chloride and 2-chlorobutadiene in *Salmonella typhimurium*. *Nature* **255**, 641-643.



- Bieler, G.S., and Williams, R.L. (1993). Ratio estimates, the delta method, and quantal response tests for increased carcinogenicity. *Biometrics* **49**, 793-801.
- Boorman, G.A., Montgomery, C.A., Jr., Eustis, S.L., Wolfe, M.J., McConnell, E.E., and Hardisty, J.F. (1985). Quality assurance in pathology for rodent carcinogenicity studies. In *Handbook of Carcinogen Testing* (H.A. Milman and E.K. Weisburger, Eds.), pp. 345-357. Noyes Publications, Park Ridge, NJ.
- Brecher, G., and Schneiderman, M. (1950). Time saving device for the counting of reticulocytes. *Am. J. Clin. Pathol.* **20**, 2079-2084.
- Bronzetti, G., Bauer, C., Corsi, C., Leporini, C., Nieri, R., and del Carratore, R. (1981). Genetic activity of vinylidene chloride in yeast. *Mutat. Res.* **89**, 179-185.
- Bruckner, J.V., White, C.A., Muralidhara, S., Hines, C., and Dallas, C.E. (2010). Influence of exposure route and oral dosage regimen on 1,1-dichloroethylene toxicokinetics and target organ toxicity. *J. Pharmacol. Exp. Ther.* **333**, 519-527.
- Caspary, W.J., Lee, Y.J., Poulton, S., Myhr, B.C., Mitchell, A.D., and Rudd, C.J. (1988). Evaluation of the L5178Y mouse lymphoma cell mutagenesis assay: Quality-control guidelines and response categories. *Environ. Mol. Mutagen.* **12** (Suppl. 13), 19-36.
- Cavelier, L., Bonnet, P., Morel, G., and de Ceaurriz, J. (1996). Role of cysteine conjugation in vinylidene chloride-induced nephrotoxicity and hepatotoxicity in fasted rats. *J. Appl. Toxicol.* **16**, 109-113.
- Chieco, P., Molsen, M.T., and Reynolds, E.S. (1981). Effect of administrative vehicle on oral 1,1-dichloroethylene toxicity. *Toxicol. Appl. Pharmacol.* **57**, 146-155.
- Code of Federal Regulations (CFR) **21**, Part 58.
- Colotta, F., Allavena, P., Sica, A., Garlanda, C., and Mantovani, A. (2009). Cancer-related inflammation, the seventh hallmark of cancer: Links to genetic instability. *Carcinogenesis* **30**, 1073-1081.
- Cossec, B., Cavelier, L., Moitessier-Bergé, N., Morel, G., and de Ceaurriz, J. (1996). Formation of GSH-derivatives as a pathway for inactive intermediates in vinylidene chloride-treated rats. *Toxicol. Lett.* **89**, 223-229.
- Costa, A.K., and Ivanetich, K.M. (1982). Vinylidene chloride: Its metabolism by hepatic microsomal cytochrome P-450 *in vitro*. *Biochem. Pharmacol.* **31**, 2083-2092.
- Cotti, G., Maltoni, C., and Lefemine, G. (1988). Long-term carcinogenicity bioassay on vinylidene chloride administered by inhalation to Sprague-Dawley rats. *Ann. N. Y. Acad. Sci.* **534**, 160-168.
- Cox, D.R. (1972). Regression models and life-tables. *J. R. Stat. Soc.* **B34**, 187-220.
- Crawford, B.D. (1985). Perspectives on the somatic mutation model of carcinogenesis. In *Advances in Modern Environmental Toxicology. Mechanisms and Toxicity of Chemical Carcinogens and Mutagens* (M.A. Mehlman, W.G. Flamm, and R.J. Lorentzen, Eds.), pp. 13-59. Princeton Scientific Publishing Co., Inc., Princeton, NJ.
- Dallas, C.E., Weir, F.W., Feldman, S., Putcha, L., and Bruckner, J.V. (1983). The uptake and disposition of 1,1-dichloroethylene in rats during inhalation exposure. *Toxicol. Appl. Pharmacol.* **68**, 140-151.
- Dekant, W., Berthold, K., Vamvakas, S., Henschler, D., and Anders, M.W. (1988). Thioacylating intermediates as metabolites of S-(1,2-dichlorovinyl)-L-cysteine and S-(1,2,2-trichlorovinyl)-L-cysteine formed by cysteine conjugate beta-lyase. *Chem. Res. Toxicol.* **1**, 175-178.
- Dixon, W.J., and Massey, F.J., Jr. (1957). *Introduction to Statistical Analysis*, 2nd ed., pp. 276-278, 412. McGraw-Hill Book Company, Inc., New York.

- Dowsley, T.F., Forkert, P.G., Benesch, L.A., and Bolton, J.L. (1995). Reaction of glutathione with the electrophilic metabolites of 1,1-dichloroethylene. *Chem. Biol. Interact.* **95**, 227-244.
- Dowsley, T.F., Ulreich, J.B., Bolton, J.L., Park, S.S., and Forkert, P.G. (1996). CYP2E1-dependent bioactivation of 1,1-dichloroethylene in murine lung: Formation of reactive intermediates and glutathione conjugates. *Toxicol. Appl. Pharmacol.* **139**, 42-48.
- Dowsley, T.F., Reid, K., Petsikas, D., Ulreich, J.B., Fisher, R.L., and Forkert, P.G. (1999). Cytochrome P-450-dependent bioactivation of 1,1-dichloroethylene to a reactive epoxide in human lung and liver microsomes. *J. Pharmacol. Exp. Ther.* **289**, 641-648.
- Drevon, C., and Kuroki, T. (1979). Mutagenicity of vinyl chloride, vinylidene chloride and chloroprene in V79 Chinese hamster cells. *Mutat. Res.* **67**, 173-182.
- D'Souza, R.W., and Andersen, M.E. (1988). Physiologically based pharmacokinetic model for vinylidene chloride. *Toxicol. Appl. Pharmacol.* **95**, 230-240.
- Dunn, O.J. (1964). Multiple comparisons using rank sums. *Technometrics* **6**, 241-252.
- Dunnett, C.W. (1955). A multiple comparison procedure for comparing several treatments with a control. *J. Am. Stat. Assoc.* **50**, 1096-1121.
- Elfarra, A.A., and Anders, M.W. (1984). Renal processing of glutathione conjugates: Role in nephrotoxicity. *Biochem. Pharmacol.* **33**, 3729-3732.
- Elfarra, A.A., Jakobson, I., and Anders, M.W. (1986). Mechanism of S-(1,2-dichlorovinyl)glutathione-induced nephrotoxicity. *Biochem. Pharmacol.* **35**, 283-288.
- Eyre, R.J., Stevens, D.K., Parker, J.C., and Bull, R.J. (1995a). Renal activation of trichloroethene and S-(1,2-dichlorovinyl)-L-cysteine and cell proliferative responses in the kidneys of F344 rats and B6C3F1 mice. *J. Toxicol. Environ. Health* **46**, 465-481.
- Eyre, R.J., Stevens, D.K., Parker, J.C., and Bull, R.J. (1995b). Acid-labile adducts to protein can be used as indicators of the cysteine S-conjugate pathway of trichloroethene metabolism. *J. Toxicol. Environ. Health* **46**, 443-464.
- Forkert, P.G. (1999a). *In vivo* formation and localization of 1,1-dichloroethylene epoxide in murine liver: Identification of its glutathione conjugate 2-S-glutathionyl acetate. *J. Pharmacol. Exp. Ther.* **290**, 1299-1306.
- Forkert, P.G. (1999b). 1,1-Dichloroethylene-induced Clara cell damage is associated with *in situ* formation of the reactive epoxide. Immunohistochemical detection of its glutathione conjugate. *Am. J. Respir. Cell Mol. Biol.* **20**, 1310-1318.
- Forkert, P.G. (2001). Mechanisms of 1,1-dichloroethylene-induced cytotoxicity in lung and liver. *Drug Metab. Rev.* **33**, 49-80.
- Forkert, P.G., and Moussa, M. (1991). 1,1-dichloroethylene elicits dose-dependent alterations in covalent binding and glutathione in murine liver. *Drug Metab. Dispos.* **19**, 580-586.
- Forkert, P.G., and Moussa, M. (1993). Temporal effects of 1,1-dichloroethylene on nonprotein sulfhydryl content in murine lung and liver. *Drug Metab. Dispos.* **21**, 770-776
- Forkert, P.G., and Reynolds, E.S. (1982). 1,1-dichloroethylene-induced pulmonary injury. *Exp. Lung Res.* **3**, 57-68.
- Forkert, P.G., Forkert, L., Farooqui, M., and Reynolds, E.S. (1985). Lung injury and repair: DNA synthesis following 1,1-dichloroethylene. *Toxicology* **36**, 199-214.

- Foureman, P., Mason, J.M., Valencia, R., and Zimmering, S. (1994). Chemical mutagenesis testing in *Drosophila*. IX. Results of 50 coded compounds tested for the National Toxicology Program. *Environ. Mol. Mutagen.* **23**, 51-63.
- Fu, D., Calvo, J.A., and Samson, L.D. (2012). Balancing repair and tolerance of DNA damage caused by alkylating agents. *Nat. Rev. Cancer* **12**, 104-120.
- Gart, J.J., Chu, K.C., and Tarone, R.E. (1979). Statistical issues in interpretation of chronic bioassay tests for carcinogenicity. *JNCI* **62**, 957-974.
- Gibbs, D.S., and Wessling, R.A. (1983). Vinylidene chloride and poly(vinylidene chloride). In *Kirk-Othmer Encyclopedia of Chemical Technology*, 3rd ed., Vol. 23, pp. 764-798. Wiley-Interscience, New York.
- Girard, D.M., and Sager, D.B. (1987). The use of Markov chains to detect subtle variation in reproductive cycling. *Biometrics* **43**, 225-234.
- Greim, H., Bonse, G., Radwan, Z., Reichert, D., and Henschler, D. (1975). Mutagenicity in vitro and potential carcinogenicity of chlorinated ethylenes as a function of metabolic oxiran formation. *Biochem. Pharmacol.* **24**, 2013-2017.
- Hall, R.L. and Everds, N.E. (2008). Principles of clinical pathology for toxicology studies. In *Principles and Methods of Toxicology*, 5th ed. (A.W. Hayes, Ed.), pp. 1317-1358. CRC Press, Boca Raton, FL.
- Hanahan, D., and Weinberg, R.A. (2000). The hallmarks of cancer. *Cell* **100**, 57-70.
- Hanahan, D., and Weinberg, R.A. (2011). Hallmarks of cancer: The next generation. *Cell* **144**, 646-674.
- Hathway, D.E. (1977). Comparative mammalian metabolism of vinyl chloride and vinylidene chloride in relation to oncogenic potential. *Environ. Health Perspect.* **21**, 55-59.
- Hazardous Substances Data Bank (HSDB) (2003). 1,1-Dichloroethylene. National Institute for Occupational Safety and Health. HSDB database available through the National Library of Medicine MEDLARS System.
- Heddle, J.A., Hite, M., Kirkhart, B., Mavournin, K., MacGregor, J.T., Newell, G.W., and Salamone, M.F. (1983). The induction of micronuclei as a measure of genotoxicity. A report of the U.S. Environmental Protection Agency Gene-Tox Program. *Mutat. Res.* **123**, 61-118.
- Henschler, D. (1977). Metabolism and mutagenicity of halogenated olefins—a comparison of structure and activity. *Environ. Health Perspect.* **21**, 61-64.
- Hong, C.B., Winston, J.M., Thornburg, L.P., Lee, C.C., and Woods, J.S. (1981). Follow-up study on the carcinogenicity of vinyl chloride and vinylidene chloride in rats and mice: Tumor incidence and mortality subsequent to exposure. *J. Toxicol. Environ. Health* **7**, 909-924.
- International Agency for Research on Cancer (IARC) (1986). *IARC Monographs on the Evaluation of the Carcinogenic Risk of Chemicals to Humans. Some Chemicals Used in Plastics and Elastomers*, Vol. 39. pp. 195-226. IARC, Lyon, France.
- International Agency for Research on Cancer (IARC) (1999). *IARC Monographs on the Evaluation of Carcinogenic Risks to Humans. Re-evaluation of Some Organic Chemicals, Hydrazine and Hydrogen Peroxide*, Vol. 71, pp. 1163-1180. IARC, Lyon, France.
- International Programme on Chemical Safety (IPCS) (1990). Environmental Health Criteria 100, Vinylidene Chloride. World Health Organization, Geneva, Switzerland.
- Jackson, N.M., and Conolly, R.B. (1985). Acute nephrotoxicity of 1,1-dichloroethylene in the rat after inhalation exposure. *Toxicol. Lett.* **29**, 191-199.

- Jaeger, R.J., Trabulus, M.J., and Murphy, S.D. (1973). The interaction of adrenalectomy, partial adrenal replacement therapy, and starvation with hepatotoxicity and lethality after 1,1-dichloroethylene intoxication. *Toxicol. Appl. Pharmacol.* **25**, 491 (Abstr.).
- Jaeger, R.J., Conolly, R.B., and Murphy, S.D. (1974). Effect of 18 hr fast and glutathione depletion on 1,1-dichloroethylene-induced hepatotoxicity and lethality in rats. *Exp. Mol. Pathol.* **20**, 187-198.
- Jaeger, R.J., Conolly, R.B., and Murphy, S.D. (1975a). Short-term inhalation toxicity of halogenated hydrocarbons: Effects on fasting rats. *Arch. Environ. Health.* **30**, 26-31.
- Jaeger, R.J., Conolly, R.B., Reynolds, E.S., and Murphy, S.D. (1975b). Biochemical toxicology of unsaturated halogenated monomers. *Environ. Health Perspect.* **11**, 121-128.
- Jaeger, R.J., Shoner, L.G., and Coffman, L. (1977). 1,1-Dichloroethylene hepatotoxicity: Proposed mechanism of action and distribution and binding of <sup>14</sup>C radioactivity following inhalation exposure in rats. *Environ. Health Perspect.* **21**, 113-119.
- Jenkins, L.J., Jr., and Andersen, M.E. (1978). 1,1-Dichloroethylene nephrotoxicity in the rat. *Toxicol. Appl. Pharmacol.* **46**, 131-142.
- Jenkins, L.J., Jr., Trabulus, M.J., and Murphy, S.D. (1972). Biochemical effects of 1,1-dichloroethylene in rats: Comparison with carbon tetrachloride and 1,2-dichloroethylene. *Toxicol. Appl. Pharmacol.* **23**, 501-510.
- Jonckheere, A.R. (1954). A distribution-free *k*-sample test against ordered alternatives. *Biometrika* **41**, 133-145.
- Jones, B.K., and Hathway, D.E. (1978a). The biological fate of vinylidene chloride in rats. *Chem. Biol. Interact.* **20**, 27-41.
- Jones, B.K., and Hathway, D.E. (1978b). Differences in metabolism of vinylidene chloride between mice and rats. *Br. J. Cancer.* **37**, 411-417.
- Jones, B.K., and Hathway, D.E. (1978c). Tissue-mediated mutagenicity of vinylidene chloride in *Salmonella typhimurium* TA1535. *Cancer Lett.* **5**, 1-6.
- Jones, J.A., Kaphalia, L., Treinen-Moslen, M., and Liebler, D.C. (2003). Proteomic characterization of metabolites, protein adducts, and biliary proteins in rats exposed to 1,1-dichloroethylene or diclofenac. *Chem. Res. Toxicol.* **16**, 1306-1317.
- Kainz, A., Cross, H., Freeman, S., Gescher, A., and Chipman, J.K. (1993). Effects of 1,1-dichloroethylene and some of its metabolites on the functional viability of mouse hepatocytes. *Fundam. Appl. Toxicol.* **21**, 140-148.
- Kanz, M.F., Whitehead, R.F., Ferguson, A.E., and Molesen, M.T. (1988). Potentiation of 1,1-dichloroethylene hepatotoxicity: Comparative effects of hyperthyroidism and fasting. *Toxicol. Appl. Pharmacol.* **95**, 93-103.
- Kanz, M.F., Taj, Z., and Moslen, M.T. (1991). 1,1-Dichloroethylene hepatotoxicity: Hypothyroidism decreases metabolism and covalent binding but not injury in the rat. *Toxicology* **70**, 213-229.
- Kaplan, E.L., and Meier, P. (1958). Nonparametric estimation from incomplete observations. *J. Am. Stat. Assoc.* **53**, 457-481.
- Koch, R., Schlegelmilch, R., and Wolf, H.U. (1988). Genetic effects of chlorinated ethylenes in the yeast *Saccharomyces cerevisiae*. *Mutat. Res.* **206**, 209-216.
- Krantz, S.B. (1991). Erythropoietin. *Blood* **77**, 419-434.

- Lash, L.H., Jones, D.P., and Anders, M.W. (1988). Glutathione homeostasis and glutathione S-conjugate toxicity in kidney. *In Reviews in Biochemical Toxicology*, Vol. 9, pp. 29-67. Elsevier, New York.
- Lash, L.H., Fisher, J.W., Lipscomb, J.C., and Parker, J.C. (2000). Metabolism of trichloroethylene. *Environ. Health Perspect.* **108**, 177-200.
- Lee, C.C., Bhandari, J.C., Winston, J.M., House, W.B., Peters, P.J., Dixon, R.L., and Woods, J.S. (1977). Inhalation toxicity of vinyl chloride and vinylidene chloride. *Environ. Health Perspect.* **21**, 25-32.
- Lee, C.C., Bhandari, J.C., Winston, J.M., House, W.B., Dixon, R.L., and Woods, J.S. (1978). Carcinogenicity of vinyl chloride and vinylidene chloride. *J. Toxicol. Environ. Health* **4**, 15-30.
- Lee, R.P., and Forkert, P.G. (1994). *In vitro* biotransformation of 1,1-dichloroethylene by hepatic cytochrome P-450 2E1 in mice. *J. Pharmacol. Exp. Ther.* **270**, 371-376.
- Liebler, D.C., and Guengerich, F.P. (1983). Olefin oxidation by cytochrome P-450: Evidence for group migration in catalytic intermediates formed with vinylidene chloride and trans-1-phenyl-1-butene. *Biochemistry* **22**, 5482-5489.
- Liebler, D.C., Meredith, M.J., and Guengerich, F.P. (1985). Formation of glutathione conjugates by reactive metabolites of vinylidene chloride in microsomes and isolated hepatocytes. *Cancer Res.* **45**, 186-193.
- Liebler, D.C., Latwesen, D.G., and Reeder, T.C. (1988). S-(2-chloroacetyl)glutathione, a glutathione thiol ester and putative metabolite of 1,1-dichloroethylene. *Biochemistry* **27**, 3652-3657.
- McConnell, E.E., Solleveld, H.A., Swenberg, J.A., and Boorman, G.A. (1986). Guidelines for combining neoplasms for evaluation of rodent carcinogenesis studies. *JNCI* **76**, 283-289.
- McGregor, D.B., Brown, A.G., Cattanaach, P., Edwards, I., McBride, D., Riach, C., Shepherd, W., and Caspary, W.J. (1991). Responses of the L5178Y mouse lymphoma forward mutation assay: V. Gases and vapors. *Environ. Mol. Mutagen.* **17**, 122-129.
- MacGregor, J.T., Wehr, C.M., Henika, P.R., and Shelby, M.D. (1990). The *in vivo* erythrocyte micronucleus test: Measurement at steady state increases assay efficiency and permits integration with toxicity studies. *Fundam. Appl. Toxicol.* **14**, 513-522.
- McKenna, M.J., Watanabe, P.G., and Gehring, P.J. (1977). Pharmacokinetics of vinylidene chloride in the rat. *Environ. Health Perspect.* **21**, 99-105.
- McKenna, M.J., Zempel, J.A., Madrid, E.O., and Gehring, P.J. (1978a). The pharmacokinetics of [<sup>14</sup>C] vinylidene chloride in rats following inhalation exposure. *Toxicol. Appl. Pharmacol.* **45**, 599-610.
- McKenna, M.J., Zempel, J.A., Madrid, E.O., Braun, W.H., and Gehring, P.J. (1978b). Metabolism and pharmacokinetic profile of vinylidene chloride in rats following oral administration. *Toxicol. Appl. Pharmacol.* **45**, 821-835.
- Maltoni, C., Cotti, G., Morisi, L., and Chieco P. (1977). Carcinogenicity bioassays of vinylidene chloride. Research plan and early results. *Med. Lav.* **68**, 241-262.
- Maltoni, C.G., Lefemine, G., and Patella, F. (1985). Experimental research on vinylidene chloride carcinogenesis. In *Archives of Research on Industrial Carcinogenesis* (C. Maltoni and M.A. Mehlman, Eds.), Vol. III. Princeton Scientific, Princeton, NJ.
- Margolin, B.H., Collings, B.J., and Mason, J.M. (1983). Statistical analysis and sample-size determinations for mutagenicity experiments with binomial responses. *Environ. Mutagen.* **5**, 705-716.

- Maronpot, R.R., and Boorman, G.A. (1982). Interpretation of rodent hepatocellular proliferative alterations and hepatocellular tumors in chemical safety assessment. *Toxicol. Pathol.* **10**, 71-80.
- Mason, J.M., Valencia, R., and Zimmering, S. (1992). Chemical mutagenesis testing in *Drosophila*: VIII. Reexamination of equivocal results. *Environ. Mol. Mutagen.* **19**, 227-234.
- The Merck Index* (2006). 14th ed. (M.J. O'Neil, Ed.), p. 1720. Merck and Company, Inc., Whitehouse Station, NJ.
- Miller, J.A., and Miller, E.C. (1977). Ultimate chemical carcinogens as reactive mutagenic electrophiles. In *Origins of Human Cancer* (H.H. Hiatt, J.D. Watson, and J.A. Winsten, Eds.), pp. 605-627. Cold Spring Harbor Laboratory, Cold Spring Harbor, NY.
- Mortelmans, K., Haworth, S., Lawlor, T., Speck, W., Tainer, B., and Zeiger, E. (1986). *Salmonella* mutagenicity tests: II. Results from the testing of 270 chemicals. *Environ. Mutagen.* **8** (Suppl. 7), 1-119.
- Moslen, M.T., Poisson, L.R., and Reynolds, E.S. (1985). Cholestasis and increased biliary excretion of inulin in rats given 1,1-dichloroethylene. *Toxicology* **34**, 201-209.
- Moslen, M.T., Whitehead, R.F., Ferguson, A.E., and Kanz, M.F. (1989). Protection by L-2-oxothiazolidine-4-carboxylate, a cysteine prodrug, against 1,1-dichloroethylene hepatotoxicity in rats is associated with decreases in toxin metabolism and cytochrome P-450. *J. Pharmacol. Exp. Ther.* **248**, 157-163.
- Moussa, M., and Forkert, P.G. (1992). 1,1-Dichloroethylene-induced alterations in glutathione and covalent binding in murine lung: Morphological, histochemical, and biochemical studies. *J. Pathol.* **166**, 199-207.
- Murray, F.J., Nitschke, K.D., Rampy, L.W., and Schwetz, B.A. (1979). Embryotoxicity and fetotoxicity of inhaled or ingested vinylidene chloride in rats and rabbits. *Toxicol. Appl. Pharmacol.* **30**, 189-202.
- Mutsaers, S.E., McAnulty, R.J., Laurent, G.J., Versnel, M.A., Whitaker, D., and Papadimitriou, J.M. (1997). Cytokine regulation of mesothelial cell proliferation in vitro and in vivo. *Eur. J. Cell Biol.* **72**, 24-29.
- National Toxicology Program (NTP) (1982). Carcinogenesis Bioassay of Vinylidene Chloride (CAS No. 75-35-4) in F344 Rats and B6C3F<sub>1</sub> Mice (Gavage Study). Technical Report Series No. 228. NIH Publication No. 82-1784. U.S. Department of Health and Human Services, Public Health Service, National Institutes of Health, Research Triangle Park, NC., and Bethesda, MD.
- Nitschke, K.D., Smith, F.A., Quast, J.F., Norris, J.M., and Schwetz, B.A. (1983). A three-generation rat reproductive toxicity study of vinylidene chloride in the drinking water. *Fundam. Appl. Toxicol.* **3**, 75-79.
- Oesch, F., Protić-Sabljić, M., Friedberg, T., Klimisch, H.J., and Glatt, H.R. (1983). Vinylidene chloride: Changes in drug-metabolizing enzymes, mutagenicity and relation to its targets for carcinogenesis. *Carcinogenesis* **4**, 1031-1038.
- Okine, L.K., and Gram, T.E. (1986). In vitro studies on the metabolism and covalent binding of [<sup>14</sup>C]1,1-dichloroethylene by mouse liver, kidney and lung. *Biochem. Pharmacol.* **35**, 2789-2795.
- Okine, L.K., Goochee, J.M., and Gram, T.E. (1985). Studies on the distribution and covalent binding of 1,1-dichloroethylene in the mouse. Effect of various pretreatments on covalent binding *in vivo*. *Biochem. Pharmacol.* **34**, 4051-4057.
- Piegorsch, W.W., and Bailer, A.J. (1997). *Statistics for Environmental Biology and Toxicology*, Section 6.3.2. Chapman and Hall, London.
- Ponomarkov, V., and Tomatis, L. (1980). Long-term testing of vinylidene chloride and chloroprene for carcinogenicity in rats. *Oncology* **37**, 136-141.

- Portier, C.J., and Bailer, A.J. (1989). Testing for increased carcinogenicity using a survival-adjusted quantal response test. *Fundam. Appl. Toxicol.* **12**, 731-737.
- Portier, C.J., Hedges, J.C., and Hoel, D.G. (1986). Age-specific models of mortality and tumor onset for historical control animals in the National Toxicology Program's carcinogenicity experiments. *Cancer Res.* **46**, 4372-4378.
- Putchu, L., Bruckner, J.V., D'Souza, R., Desai, F., and Feldman, S. (1986). Toxicokinetics and bioavailability of oral and intravenous 1,1-dichloroethylene. *Fundam. Appl. Toxicol.* **6**, 240-250.
- Quast, J.F., Humiston, C.G., Wade, C.E., Ballard, J., Beyer, J.E., Schwetz, R.W., and Norris, J.M. (1983). A chronic toxicity and oncogenicity study in rats and subchronic toxicity study in dogs on ingested vinylidene chloride. *Fundam. Appl. Toxicol.* **3**, 55-62.
- Quast, J.F., McKenna, M.J., Rampy, L.W., and Norris, J.M. (1986). Chronic toxicity and oncogenicity study on inhaled vinylidene chloride in rats. *Fundam. Appl. Toxicol.* **6**, 105-144.
- Rampy, L.W., Quast, J.F., Humiston, C.G., Balmer, M.F., and Schwetz, B.A. (1977). Interim results of two-year toxicological studies in rats of vinylidene chloride incorporated in the drinking water or administered by repeated inhalation. *Environ. Health Perspect.* **21**, 33-43.
- Rao, G.N. (1996). New diet (NTP-2000) for rats in the National Toxicology Program toxicity and carcinogenicity studies. *Fundam. Appl. Toxicol.* **32**, 102-108.
- Rao, G.N. (1997). New nonpurified diet (NTP-2000) for rodents in the National Toxicology Program's toxicology and carcinogenesis studies. *J. Nutr.* **127**, 842s-846s.
- Reichert, D., Werner, H.W., and Henschler, D. (1978). Role of liver glutathione in 1,1-dichloroethylene metabolism and hepatotoxicity in intact rats and isolated perfused rat liver. *Arch. Toxicol.* **41**, 169-178.
- Reichert, D., Werner, H.W., Metzler, M. and Henschler, D. (1979). Molecular mechanism of 1,1-dichloroethylene toxicity: Excreted metabolites reveal different pathways of reactive intermediates. *Arch. Toxicol.* **42**, 159-169.
- Reitz, R.H., Watanabe, P.G., McKenna, M.J., Quast, J.F., and Gehring, P.J. (1980). Effects of vinylidene chloride on DNA synthesis and DNA repair in the rat and mouse: A comparative study with dimethylnitrosamine. *Toxicol. Appl. Pharmacol.* **52**, 357-370.
- Reynolds, E.S., Moslen, M.T., Boor, J.P., and Jaeger, R.J. (1980). 1,1-dichloroethylene hepatotoxicity. Time course of GSH changes and biochemical aberrations. *Am. J. Pathol.* **101**, 331-342.
- Roberts, S.M., Jordan, K.E., Warren, D.A., Britt, J.K., and James, R.C. (2002). Evaluation of the carcinogenicity of 1,1-dichloroethylene (vinylidene chloride). *Regul. Toxicol. Pharmacol.* **35**, 44-55.
- Sawada, M., Sofuni, T., and Ishidate, M., Jr. (1987). Cytogenetic studies on 1,1-dichloroethylene and its two isomers in mammalian cells *in vitro* and *in vivo*. *Mutat. Res.* **187**, 157-163.
- Schmid, W. (1975). The micronucleus test. *Mutat. Res.* **31**, 9-15.
- Shelby, M.D., and Witt, K.L. (1995). Comparison of results from mouse bone marrow chromosome aberration and micronucleus tests. *Environ. Mol. Mutagen.* **25**, 302-313.
- Shelby, M.D., Erexson, G.L., Hook, G.J., and Tice, R.R. (1993). Evaluation of a three-exposure mouse bone marrow micronucleus protocol: Results with 49 chemicals. *Environ. Mol. Mutagen.* **21**, 160-179.
- Shirley, E. (1977). A non-parametric equivalent of Williams' test for contrasting increasing dose levels of a treatment. *Biometrics* **33**, 386-389.

- Short, R.D., Winston, J.M., Minor, J.L., Seifter, J., and Lee, C.C. (1977a). Effect of various treatments on toxicity of inhaled vinylidene chloride. *Environ. Health Perspect.* **21**, 125-129.
- Short, R.D., Winston, J.M., Minor, J.L., Hong, C.B., Seifter, J., and Lee, C.C. (1977b). Toxicity of vinylidene chloride in mice and rats and its alterations by various treatments. *J. Toxicol. Environ. Health* **3**, 913-921.
- Short, R.D., Minor, J.L., Winston, J.M., and Lee, C.C. (1977c). A dominant lethal study in male rats after repeated exposures to vinyl chloride or vinylidene chloride. *J. Toxicol. Environ. Health* **3**, 965-968.
- Siegel, J., Jones, R.A., Coon, R.A., and Lyon, J.P. (1971). Effects on experimental animals of acute, repeated and continuous inhalation exposures to dichloroacetylene mixtures. *Toxicol. Appl. Pharmacol.* **18**, 168-174.
- Siegers, C.P., Horn, W., and Younes, M. (1985). Effect of phorone-induced glutathione depletion on the metabolism and hepatotoxicity of carbon tetrachloride and vinylidene chloride in rats. *J. Appl. Toxicol.* **5**, 352-356.
- Simmonds, A.C., Reilly, C.A., Baldwin, R.M., Ghanayem, B.I., Lanza, D.L., Yost, G.S., Collins, K.S., and Forkert, P.G. (2004). Bioactivation of 1,1-dichloroethylene to its epoxide by CYP2E1 and CYP2F enzymes. *Drug Metab. Dispos.* **32**, 1032-1039.
- Straus, D.S. (1981). Somatic mutation, cellular differentiation, and cancer causation. *JNCI* **67**, 233-241.
- Tarone, R.E. (1975). Tests for trend in life table analysis. *Biometrika* **62**, 679-682.
- Tennant, R.W., Margolin, B.H., Shelby, M.D., Zeiger, E., Haseman, J.K., Spalding, J., Caspary, W., Resnick, M., Stasiewicz, S., Anderson, B., and Minor, R. (1987). Prediction of chemical carcinogenicity in rodents from in vitro genetic toxicity assays. *Science* **236**, 933-941.
- Torkelson, T.R. (1994). Halogenated aliphatic hydrocarbons containing chlorine, bromine, and iodine. In *Patty's Industrial Hygiene and Toxicology*, 4th ed. (G.D. Clayton and F.E. Clayton, Eds.), Vol. 2, pp. 4181-4189. Wiley-Interscience, New York.
- U.S. Environmental Protection Agency (USEPA) (2002). Toxicological Review of 1,1-Dichloroethylene (CAS No. 75-35-4) in Support of Summary Information on the Integrated Risk Information System (IRIS). EPA Report No. EPA/635/R02/002. U.S. Environmental Protection Agency, Washington, DC.
- Viola, P.L., and Caputo, A. (1977). Carcinogenicity studies on vinylidene chloride. *Environ. Health Perspect.* **21**, 45-47.
- Wallace, L.A. (1991). Comparison of risks from outdoor and indoor exposure to toxic chemicals. *Environ. Health Perspect.* **95**, 7-13.
- Williams, D.A. (1971). A test for differences between treatment means when several dose levels are compared with a zero dose control. *Biometrics* **27**, 103-117.
- Williams, D.A. (1972). The comparison of several dose levels with a zero dose control. *Biometrics* **28**, 519-531.
- Williams, D.A. (1986). A note on Shirley's nonparametric test for comparing several dose levels with a zero-dose control. *Biometrics* **42**, 183-186.
- Witt, K.L., Knapton, A., Wehr, C.M., Hook, G.J., Mirsalis, J., Shelby, M.D., and MacGregor, J.T. (2000). Micronucleated erythrocyte frequency in peripheral blood of B6C3F1 mice from short-term, prechronic, and chronic studies of the NTP Carcinogenesis Bioassay Program. *Environ. Mol. Mutagen.* **36**, 163-194.
- Zeiger, E., Haseman, J.K., Shelby, M.D., Margolin, B.H., and Tennant, R.W. (1990). Evaluation of four in vitro genetic toxicity tests for predicting rodent carcinogenicity: Confirmation of earlier results with 41 additional chemicals. *Environ. Mol. Mutagen.* **16** (Suppl. 18), 1-14.





**APPENDIX A**  
**SUMMARY OF LESIONS IN MALE RATS**  
**IN THE 2-YEAR INHALATION STUDY**  
**OF VINYLIDENE CHLORIDE**

<b>TABLE A1</b>	<b>Summary of the Incidence of Neoplasms in Male Rats in the 2-Year Inhalation Study of Vinylidene Chloride .....</b>	<b>A-2</b>
<b>TABLE A2</b>	<b>Statistical Analysis of Primary Neoplasms in Male Rats in the 2-Year Inhalation Study of Vinylidene Chloride .....</b>	<b>A-6</b>
<b>TABLE A3a</b>	<b>Historical Incidence of Malignant Mesothelioma in Control Male F344/N Rats.....</b>	<b>A-10</b>
<b>TABLE A3b</b>	<b>Historical Incidence of Renal Tubule Neoplasms in Control Male F344/N Rats.....</b>	<b>A-10</b>
<b>TABLE A4</b>	<b>Summary of the Incidence of Nonneoplastic Lesions in Male Rats in the 2-Year Inhalation Study of Vinylidene Chloride .....</b>	<b>A-11</b>

**TABLE A1**  
**Summary of the Incidence of Neoplasms in Male Rats in the 2-Year Inhalation Study**  
**of Vinylidene Chloride<sup>a</sup>**

	Chamber Control	25 ppm	50 ppm	100 ppm
<b>Disposition Summary</b>				
Animals initially in study	50	50	50	50
Early deaths				
Moribund	21	15	23	27
Natural deaths	4	8	5	4
Survivors				
Terminal kill	25	27	22	19
Animals examined microscopically	50	50	50	50
<b>Alimentary System</b>				
Esophagus	(50)	(49)	(49)	(50)
Carcinoma, metastatic, thyroid gland			1 (2%)	
Intestine large, cecum	(48)	(44)	(45)	(46)
Intestine large, colon	(47)	(46)	(47)	(48)
Adenoma				1 (2%)
Intestine large, rectum	(46)	(47)	(46)	(49)
Intestine small, duodenum	(47)	(45)	(45)	(49)
Intestine small, ileum	(47)	(45)	(45)	(47)
Intestine small, jejunum	(47)	(43)	(45)	(47)
Sarcoma, stromal		1 (2%)		
Liver	(50)	(50)	(50)	(50)
Carcinoma, metastatic, urinary bladder		1 (2%)		
Cholangiocarcinoma				1 (2%)
Hepatocellular adenoma	1 (2%)	1 (2%)		
Mesentery	(16)	(15)	(21)	(23)
Carcinoma, metastatic, urinary bladder		1 (7%)		
Pancreas	(50)	(50)	(50)	(49)
Carcinoma, metastatic, urinary bladder		1 (2%)		
Acinus, adenoma			1 (2%)	
Acinus, carcinoma				1 (2%)
Duct, carcinoma			1 (2%)	
Salivary glands	(50)	(50)	(50)	(50)
Stomach, forestomach	(50)	(50)	(50)	(50)
Stomach, glandular	(49)	(50)	(49)	(50)
Tongue	(0)	(1)	(0)	(2)
Squamous cell papilloma		1 (100%)		
Tooth	(1)	(0)	(0)	(0)
<b>Cardiovascular System</b>				
Blood vessel	(1)	(0)	(1)	(0)
Heart	(50)	(50)	(50)	(50)
Fibrous histiocytoma, metastatic, skin				1 (2%)
Pericardium, osteosarcoma, metastatic, bone	1 (2%)			
<b>Endocrine System</b>				
Adrenal cortex	(49)	(50)	(49)	(50)
Adenoma	4 (8%)	4 (8%)	1 (2%)	
Adrenal medulla	(49)	(50)	(48)	(50)
Pheochromocytoma benign	5 (10%)	9 (18%)	5 (10%)	7 (14%)
Pheochromocytoma malignant	2 (4%)	1 (2%)		1 (2%)
Bilateral, pheochromocytoma benign		2 (4%)	3 (6%)	1 (2%)

**TABLE A1**  
**Summary of the Incidence of Neoplasms in Male Rats in the 2-Year Inhalation Study**  
**of Vinylidene Chloride**

	Chamber Control	25 ppm	50 ppm	100 ppm
<b>Endocrine System</b> (continued)				
Islets, pancreatic	(50)	(50)	(50)	(49)
Adenoma	2 (4%)	2 (4%)	3 (6%)	1 (2%)
Carcinoma	2 (4%)	2 (4%)	4 (8%)	4 (8%)
Parathyroid gland	(50)	(49)	(47)	(45)
Adenoma			1 (2%)	
Pituitary gland	(50)	(49)	(49)	(50)
Pars distalis, adenoma	34 (68%)	28 (57%)	26 (53%)	33 (66%)
Thyroid gland	(50)	(49)	(49)	(48)
C-cell, adenoma	4 (8%)	5 (10%)	4 (8%)	1 (2%)
C-cell, carcinoma	3 (6%)	3 (6%)	3 (6%)	3 (6%)
Follicular cell, carcinoma			1 (2%)	
<b>General Body System</b>				
Peritoneum	(0)	(2)	(4)	(3)
Osteosarcoma, metastatic, uncertain primary site				1 (33%)
Tissue, NOS	(0)	(0)	(0)	(1)
<b>Genital System</b>				
Coagulating gland	(0)	(0)	(0)	(3)
Epididymis	(50)	(50)	(50)	(50)
Penis	(0)	(0)	(1)	(0)
Preputial gland	(50)	(49)	(49)	(50)
Adenoma	2 (4%)		2 (4%)	
Carcinoma	2 (4%)	1 (2%)	3 (6%)	
Prostate	(50)	(50)	(50)	(50)
Adenoma				1 (2%)
Carcinoma, metastatic, urinary bladder		1 (2%)		
Seminal vesicle	(48)	(50)	(48)	(48)
Adenoma			1 (2%)	1 (2%)
Carcinoma, metastatic, urinary bladder		1 (2%)		
Testes	(50)	(50)	(50)	(50)
Bilateral, interstitial cell, adenoma	20 (40%)	24 (48%)	17 (34%)	14 (28%)
Interstitial cell, adenoma	12 (24%)	11 (22%)	22 (44%)	11 (22%)
<b>Hematopoietic System</b>				
Bone marrow	(49)	(49)	(48)	(49)
Lymph node	(6)	(4)	(9)	(7)
Lymph node, bronchial	(8)	(9)	(9)	(9)
Carcinoma, metastatic, thyroid gland		1 (11%)		
Osteosarcoma, metastatic, bone	1 (13%)			
Lymph node, mandibular	(1)	(1)	(1)	(0)
Lymph node, mediastinal	(28)	(21)	(24)	(30)
Lymph node, mesenteric	(50)	(50)	(50)	(50)
Spleen	(50)	(50)	(50)	(50)
Thymus	(42)	(43)	(41)	(44)
Carcinoma, metastatic, thyroid gland			1 (2%)	
<b>Integumentary System</b>				
Mammary gland	(36)	(29)	(24)	(32)
Carcinoma			1 (4%)	
Fibroadenoma	1 (3%)	1 (3%)	1 (4%)	2 (6%)

**TABLE A1**  
**Summary of the Incidence of Neoplasms in Male Rats in the 2-Year Inhalation Study**  
**of Vinylidene Chloride**

	Chamber Control	25 ppm	50 ppm	100 ppm
<b>Integumentary System (continued)</b>				
Skin	(50)	(50)	(49)	(50)
Basal cell, adenoma	1 (2%)			1 (2%)
Basal cell, carcinoma	1 (2%)			
Keratoacanthoma	3 (6%)	3 (6%)	3 (6%)	2 (4%)
Squamous cell papilloma	3 (6%)	1 (2%)	1 (2%)	1 (2%)
Trichoepithelioma	1 (2%)		2 (4%)	
Subcutaneous tissue, fibroma	1 (2%)	4 (8%)	2 (4%)	3 (6%)
Subcutaneous tissue, fibroma, multiple			1 (2%)	
Subcutaneous tissue, fibrosarcoma				1 (2%)
Subcutaneous tissue, fibrous histiocytoma				1 (2%)
Subcutaneous tissue, lipoma				1 (2%)
Subcutaneous tissue, sarcoma		2 (4%)		
Subcutaneous tissue, schwannoma malignant			1 (2%)	
<b>Musculoskeletal System</b>				
Bone	(50)	(50)	(50)	(50)
Osteoma	1 (2%)			
Osteosarcoma	1 (2%)			1 (2%)
Skeletal muscle	(3)	(4)	(7)	(11)
Carcinoma, metastatic, urinary bladder		1 (25%)		
Lipoma	1 (33%)			
Osteosarcoma, metastatic, bone	1 (33%)			
<b>Nervous System</b>				
Brain	(50)	(50)	(50)	(50)
Granular cell tumor benign			1 (2%)	
Peripheral nerve	(2)	(0)	(1)	(0)
Spinal cord	(2)	(0)	(1)	(0)
<b>Respiratory System</b>				
Larynx	(50)	(49)	(49)	(49)
Carcinoma, metastatic, thyroid gland		1 (2%)	1 (2%)	
Lung	(50)	(50)	(50)	(50)
Alveolar/bronchiolar adenoma	3 (6%)	1 (2%)	3 (6%)	3 (6%)
Alveolar/bronchiolar carcinoma		1 (2%)	1 (2%)	1 (2%)
Carcinoma, metastatic, kidney			1 (2%)	1 (2%)
Carcinoma, metastatic, thyroid gland		1 (2%)	1 (2%)	
Carcinoma, metastatic, urinary bladder		1 (2%)		
Fibrous histiocytoma, metastatic, skin				1 (2%)
Osteosarcoma, metastatic, bone	1 (2%)			
Osteosarcoma, metastatic, uncertain primary site				1 (2%)
Squamous cell carcinoma		1 (2%)		
Nose	(49)	(50)	(50)	(50)
Sarcoma			1 (2%)	
Respiratory epithelium, adenoma			1 (2%)	4 (8%)
Pleura	(0)	(1)	(0)	(1)
Trachea	(50)	(49)	(49)	(48)
Carcinoma, metastatic, thyroid gland			1 (2%)	

**TABLE A1**  
**Summary of the Incidence of Neoplasms in Male Rats in the 2-Year Inhalation Study**  
**of Vinylidene Chloride**

	Chamber Control	25 ppm	50 ppm	100 ppm
<b>Special Senses System</b>				
Eye	(48)	(48)	(47)	(49)
Harderian gland	(50)	(49)	(48)	(49)
Zymbal's gland	(0)	(1)	(0)	(0)
Carcinoma		1 (100%)		
<b>Urinary System</b>				
Kidney	(50)	(50)	(49)	(50)
Mesenchymal tumor malignant	1 (2%)			1 (2%)
Renal tubule, carcinoma		2 (4%)	1 (2%)	1 (2%)
Urinary bladder	(49)	(50)	(49)	(50)
Transitional epithelium, carcinoma		2 (4%)		
<b>Systemic Lesions</b>				
Multiple organs <sup>b</sup>	(50)	(50)	(50)	(50)
Histiocytic sarcoma		2 (4%)	1 (2%)	
Leukemia mononuclear	17 (34%)	17 (34%)	16 (32%)	20 (40%)
Mesothelioma malignant	1 (2%)	12 (24%)	28 (56%)	23 (46%)
<b>Neoplasm Summary</b>				
Total animals with primary neoplasms <sup>c</sup>	50	50	49	49
Total primary neoplasms	129	145	163	147
Total animals with benign neoplasms	47	48	47	48
Total benign neoplasms	99	97	101	88
Total animals with malignant neoplasms	27	35	39	42
Total malignant neoplasms	30	48	62	59
Total animals with metastatic neoplasms	1	2	2	3
Total metastatic neoplasms	4	10	6	5
Total animals with malignant neoplasms of uncertain primary site				1

<sup>a</sup> Number of animals examined microscopically at the site and the number of animals with neoplasm

<sup>b</sup> Number of animals with any tissue examined microscopically

<sup>c</sup> Primary neoplasms: all neoplasms except metastatic neoplasms

**TABLE A2**  
**Statistical Analysis of Primary Neoplasms in Male Rats in the 2-Year Inhalation Study**  
**of Vinylidene Chloride**

	<b>Chamber Control</b>	<b>25 ppm</b>	<b>50 ppm</b>	<b>100 ppm</b>
<b>Adrenal Cortex: Adenoma</b>				
Overall rate <sup>a</sup>	4/49 (8%)	4/50 (8%)	1/49 (2%)	0/50 (0%)
Adjusted rate <sup>b</sup>	9.6%	9.9%	2.6%	0.0%
Terminal rate <sup>c</sup>	3/25 (12%)	3/27 (11%)	0/22 (0%)	0/19 (0%)
First incidence (days)	661	535	555	— <sup>e</sup>
Poly-3 test <sup>d</sup>	P=0.026N	P=0.629	P=0.207N	P=0.072N
<b>Adrenal Medulla: Benign Pheochromocytoma</b>				
Overall rate	5/49 (10%)	11/50 (22%)	8/48 (17%)	8/50 (16%)
Adjusted rate	12.0%	26.6%	21.5%	20.7%
Terminal rate	2/25 (8%)	7/27 (26%)	4/21 (19%)	5/19 (26%)
First incidence (days)	654	466	642	628
Poly-3 test	P=0.301	P=0.076	P=0.201	P=0.223
<b>Adrenal Medulla: Benign or Malignant Pheochromocytoma</b>				
Overall rate	6/49 (12%)	12/50 (24%)	8/48 (17%)	9/50 (18%)
Adjusted rate	14.3%	28.8%	21.5%	23.2%
Terminal rate	2/25 (8%)	7/27 (26%)	4/21 (19%)	6/19 (32%)
First incidence (days)	654	466	642	628
Poly-3 test	P=0.311	P=0.087	P=0.296	P=0.228
<b>Kidney (Renal Tubule): Adenoma (Step Sections)</b>				
Overall rate	3/50 (6%)	3/50 (6%)	5/49 (10%)	1/50 (2%)
Adjusted rate	7.2%	7.4%	13.1%	2.6%
Terminal rate	3/25 (12%)	1/27 (4%)	3/22 (14%)	0/19 (0%)
First incidence (days)	729 (T)	631	502	718
Poly-3 test	P=0.328N	P=0.647	P=0.304	P=0.341N
<b>Kidney (Renal Tubule): Adenoma or Carcinoma (Single and Step Sections)</b>				
Overall rate	3/50 (6%)	4/50 (8%)	6/49 (12%)	2/50 (4%)
Adjusted rate	7.2%	9.8%	15.7%	5.3%
Terminal rate	3/25 (12%)	1/27 (4%)	4/22 (18%)	1/19 (5%)
First incidence (days)	729 (T)	631	502	718
Poly-3 test	P=0.485N	P=0.484	P=0.194	P=0.546N
<b>Lung: Alveolar/bronchiolar Adenoma</b>				
Overall rate	3/50 (6%)	1/50 (2%)	3/50 (6%)	3/50 (6%)
Adjusted rate	7.0%	2.5%	7.9%	7.8%
Terminal rate	1/25 (4%)	1/27 (4%)	2/22 (9%)	2/19 (11%)
First incidence (days)	614	729 (T)	683	593
Poly-3 test	P=0.413	P=0.330N	P=0.606	P=0.612
<b>Lung: Alveolar/bronchiolar Adenoma or Carcinoma</b>				
Overall rate	3/50 (6%)	2/50 (4%)	4/50 (8%)	4/50 (8%)
Adjusted rate	7.0%	5.0%	10.6%	10.4%
Terminal rate	1/25 (4%)	2/27 (7%)	3/22 (14%)	3/19 (16%)
First incidence (days)	614	729 (T)	683	593
Poly-3 test	P=0.281	P=0.532N	P=0.435	P=0.441
<b>Nose: Adenoma</b>				
Overall rate	0/49 (0%)	0/50 (0%)	1/50 (2%)	4/50 (8%)
Adjusted rate	0.0%	0.0%	2.7%	10.5%
Terminal rate	0/25 (0%)	0/27 (0%)	1/22 (5%)	3/19 (16%)
First incidence (days)	—	—	729 (T)	635
Poly-3 test	P=0.004	— <sup>f</sup>	P=0.483	P=0.051

**TABLE A2**  
**Statistical Analysis of Primary Neoplasms in Male Rats in the 2-Year Inhalation Study**  
**of Vinylidene Chloride**

	<b>Chamber Control</b>	<b>25 ppm</b>	<b>50 ppm</b>	<b>100 ppm</b>
<b>Pancreatic Islets: Adenoma</b>				
Overall rate	2/50 (4%)	2/50 (4%)	3/50 (6%)	1/49 (2%)
Adjusted rate	4.7%	5.0%	8.0%	2.7%
Terminal rate	0/25 (0%)	2/27 (7%)	3/22 (14%)	1/19 (5%)
First incidence (days)	676	729 (T)	729 (T)	729 (T)
Poly-3 test	P=0.455N	P=0.674	P=0.449	P=0.541N
<b>Pancreatic Islets: Carcinoma</b>				
Overall rate	2/50 (4%)	2/50 (4%)	4/50 (8%)	4/49 (8%)
Adjusted rate	4.8%	5.0%	10.6%	10.6%
Terminal rate	2/25 (8%)	1/27 (4%)	3/22 (14%)	1/19 (5%)
First incidence (days)	729 (T)	723	683	676
Poly-3 test	P=0.170	P=0.677	P=0.290	P=0.290
<b>Pancreatic Islets: Adenoma or Carcinoma</b>				
Overall rate	4/50 (8%)	4/50 (8%)	7/50 (14%)	5/49 (10%)
Adjusted rate	9.5%	10.0%	18.5%	13.2%
Terminal rate	2/25 (8%)	3/27 (11%)	6/22 (27%)	2/19 (11%)
First incidence (days)	676	723	683	676
Poly-3 test	P=0.298	P=0.613	P=0.199	P=0.432
<b>Pituitary Gland (Pars Distalis): Adenoma</b>				
Overall rate	34/50 (68%)	28/49 (57%)	26/49 (53%)	33/50 (66%)
Adjusted rate	73.5%	64.5%	63.9%	74.4%
Terminal rate	17/25 (68%)	16/27 (59%)	16/21 (76%)	15/19 (79%)
First incidence (days)	562	548	418	437
Poly-3 test	P=0.429	P=0.235N	P=0.217N	P=0.561
<b>Preputial Gland: Carcinoma</b>				
Overall rate	2/50 (4%)	1/49 (2%)	3/49 (6%)	0/50 (0%)
Adjusted rate	4.6%	2.6%	7.9%	0.0%
Terminal rate	0/25 (0%)	0/26 (0%)	1/22 (5%)	0/19 (0%)
First incidence (days)	492	694	555	—
Poly-3 test	P=0.281N	P=0.536N	P=0.443	P=0.268N
<b>Preputial Gland: Adenoma or Carcinoma</b>				
Overall rate	4/50 (8%)	1/49 (2%)	5/49 (10%)	0/50 (0%)
Adjusted rate	9.3%	2.6%	13.1%	0.0%
Terminal rate	2/25 (8%)	0/26 (0%)	3/22 (14%)	0/19 (0%)
First incidence (days)	492	694	555	—
Poly-3 test	P=0.141N	P=0.211N	P=0.422	P=0.078N
<b>Skin: Squamous Cell Papilloma</b>				
Overall rate	3/50 (6%)	1/50 (2%)	1/50 (2%)	1/50 (2%)
Adjusted rate	7.2%	2.5%	2.7%	2.6%
Terminal rate	3/25 (12%)	1/27 (4%)	0/22 (0%)	1/19 (5%)
First incidence (days)	729 (T)	729 (T)	705	729 (T)
Poly-3 test	P=0.258N	P=0.323N	P=0.343N	P=0.342N
<b>Skin: Keratoacanthoma</b>				
Overall rate	3/50 (6%)	3/50 (6%)	3/50 (6%)	2/50 (4%)
Adjusted rate	7.1%	7.4%	7.9%	5.2%
Terminal rate	1/25 (4%)	2/27 (7%)	2/22 (9%)	0/19 (0%)
First incidence (days)	675	492	574	535
Poly-3 test	P=0.441N	P=0.645	P=0.617	P=0.541N



**TABLE A2**  
**Statistical Analysis of Primary Neoplasms in Male Rats in the 2-Year Inhalation Study**  
**of Vinylidene Chloride**

	<b>Chamber Control</b>	<b>25 ppm</b>	<b>50 ppm</b>	<b>100 ppm</b>
<b>Skin: Squamous Cell Papilloma or Keratoacanthoma</b>				
Overall rate	6/50 (12%)	4/50 (8%)	4/50 (8%)	3/50 (6%)
Adjusted rate	14.2%	9.9%	10.4%	7.8%
Terminal rate	4/25 (16%)	3/27 (11%)	2/22 (9%)	1/19 (5%)
First incidence (days)	675	492	574	535
Poly-3 test	P=0.244N	P=0.394N	P=0.431N	P=0.286N
<b>Skin: Trichoepithelioma, Basal Cell Adenoma, or Basal Cell Carcinoma</b>				
Overall rate	3/50 (6%)	0/50 (0%)	2/50 (4%)	1/50 (2%)
Adjusted rate	7.1%	0.0%	5.3%	2.6%
Terminal rate	1/25 (4%)	0/27 (0%)	1/22 (5%)	1/19 (5%)
First incidence (days)	661	—	637	729 (T)
Poly-3 test	P=0.356N	P=0.129N	P=0.548N	P=0.345N
<b>Skin: Squamous Cell Papilloma, Keratoacanthoma, Trichoepithelioma, Basal Cell Adenoma, or Basal Cell Carcinoma</b>				
Overall rate	9/50 (18%)	4/50 (8%)	6/50 (12%)	4/50 (8%)
Adjusted rate	21.2%	9.9%	15.5%	10.4%
Terminal rate	5/25 (20%)	3/27 (11%)	3/22 (14%)	2/19 (11%)
First incidence (days)	661	492	574	535
Poly-3 test	P=0.169N	P=0.131N	P=0.357N	P=0.152N
<b>Skin (Subcutaneous Tissue): Fibroma</b>				
Overall rate	1/50 (2%)	4/50 (8%)	3/50 (6%)	3/50 (6%)
Adjusted rate	2.4%	10.0%	7.9%	7.9%
Terminal rate	0/25 (0%)	4/27 (15%)	2/22 (9%)	3/19 (16%)
First incidence (days)	679	729 (T)	705	729 (T)
Poly-3 test	P=0.293	P=0.161	P=0.267	P=0.267
<b>Skin (Subcutaneous Tissue): Fibroma, Fibrous Histiocytoma, Fibrosarcoma, or Sarcoma</b>				
Overall rate	1/50 (2%)	6/50 (12%)	3/50 (6%)	5/50 (10%)
Adjusted rate	2.4%	14.6%	7.9%	13.1%
Terminal rate	0/25 (0%)	4/27 (15%)	2/22 (9%)	4/19 (21%)
First incidence (days)	679	294	705	617
Poly-3 test	P=0.143	P=0.051	P=0.267	P=0.079
<b>Testes: Adenoma</b>				
Overall rate	32/50 (64%)	35/50 (70%)	39/50 (78%)	25/50 (50%)
Adjusted rate	70.8%	80.5%	87.9%	58.8%
Terminal rate	21/25 (84%)	24/27 (89%)	21/22 (96%)	11/19 (58%)
First incidence (days)	551	535	500	449
Poly-3 test	P=0.072N	P=0.186	P=0.026	P=0.155N
<b>Thyroid Gland (C-Cell): Adenoma</b>				
Overall rate	4/50 (8%)	5/49 (10%)	4/49 (8%)	1/48 (2%)
Adjusted rate	9.4%	12.5%	10.9%	2.7%
Terminal rate	3/25 (12%)	3/27 (11%)	4/21 (19%)	1/19 (5%)
First incidence (days)	591	611	729 (T)	729 (T)
Poly-3 test	P=0.152N	P=0.462	P=0.563	P=0.219N
<b>Thyroid Gland (C-Cell): Carcinoma</b>				
Overall rate	3/50 (6%)	3/49 (6%)	3/49 (6%)	3/48 (6%)
Adjusted rate	7.2%	7.6%	8.0%	8.0%
Terminal rate	2/25 (8%)	2/27 (7%)	1/21 (5%)	1/19 (5%)
First incidence (days)	717	563	586	635
Poly-3 test	P=0.523	P=0.638	P=0.609	P=0.613

**TABLE A2**  
**Statistical Analysis of Primary Neoplasms in Male Rats in the 2-Year Inhalation Study**  
**of Vinylidene Chloride**

	<b>Chamber Control</b>	<b>25 ppm</b>	<b>50 ppm</b>	<b>100 ppm</b>
<b>Thyroid Gland (C-Cell): Adenoma or Carcinoma</b>				
Overall rate	7/50 (14%)	8/49 (16%)	6/49 (12%)	4/48 (8%)
Adjusted rate	16.5%	19.8%	16.0%	10.6%
Terminal rate	5/25 (20%)	5/27 (19%)	4/21 (19%)	2/19 (11%)
First incidence (days)	591	563	586	635
Poly-3 test	P=0.227N	P=0.459	P=0.597N	P=0.330N
<b>All Organs: Mononuclear Cell Leukemia</b>				
Overall rate	17/50 (34%)	17/50 (34%)	16/50 (32%)	20/50 (40%)
Adjusted rate	38.1%	39.8%	38.9%	46.5%
Terminal rate	8/25 (32%)	9/27 (33%)	6/22 (27%)	7/19 (37%)
First incidence (days)	551	560	563	437
Poly-3 test	P=0.237	P=0.522	P=0.560	P=0.278
<b>All Organs: Malignant Mesothelioma</b>				
Overall rate	1/50 (2%)	12/50 (24%)	28/50 (56%)	23/50 (46%)
Adjusted rate	2.4%	27.9%	63.4%	52.7%
Terminal rate	0/25 (0%)	5/27 (19%)	10/22 (46%)	7/19 (37%)
First incidence (days)	562	535	500	449
Poly-3 test	P<0.001	P<0.001	P<0.001	P<0.001
<b>All Organs: Benign Neoplasms</b>				
Overall rate	47/50 (94%)	48/50 (96%)	47/50 (94%)	48/50 (96%)
Adjusted rate	98.4%	99.6%	98.2%	99.2%
Terminal rate	25/25 (100%)	27/27 (100%)	22/22 (100%)	19/19 (100%)
First incidence (days)	551	466	418	437
Poly-3 test	P=0.685	P=0.780	P=0.890N	P=0.831
<b>All Organs: Malignant Neoplasms</b>				
Overall rate	27/50 (54%)	35/50 (70%)	39/50 (78%)	42/50 (84%)
Adjusted rate	56.6%	73.2%	83.9%	89.1%
Terminal rate	11/25 (44%)	16/27 (59%)	16/22 (73%)	17/19 (90%)
First incidence (days)	367	294	500	437
Poly-3 test	P<0.001	P=0.064	P=0.002	P<0.001
<b>All Organs: Benign or Malignant Neoplasms</b>				
Overall rate	50/50 (100%)	50/50 (100%)	49/50 (98%)	49/50 (98%)
Adjusted rate	100.0%	100.0%	99.9%	100.0%
Terminal rate	25/25 (100%)	27/27 (100%)	22/22 (100%)	19/19 (100%)
First incidence (days)	367	294	418	437
Poly-3 test	P=1.000	—	P=1.000	P=1.000

(T) Terminal kill

<sup>a</sup> Number of neoplasm-bearing animals/number of animals examined. Denominator is number of animals examined microscopically for adrenal gland, kidney, lung, nose, pancreatic islets, pituitary gland, preputial gland, testes, and thyroid gland; for other tissues, denominator is number of animals necropsied.

<sup>b</sup> Poly-3 estimated neoplasm incidence after adjustment for intercurrent mortality

<sup>c</sup> Observed incidence at terminal kill

<sup>d</sup> Beneath the chamber control incidence is the P value associated with the trend test. Beneath the exposed group incidence are the P values corresponding to pairwise comparisons between the chamber controls and that exposed group. The Poly-3 test accounts for differential mortality in animals that do not reach terminal kill. A negative trend or a lower incidence in an exposure group is indicated by N.

<sup>e</sup> Not applicable; no neoplasms in animal group

<sup>f</sup> Value of statistic cannot be computed.

**TABLE A3a**  
**Historical Incidence of Malignant Mesothelioma in Control Male F344/N Rats<sup>a</sup>**

Study (Study Start)	Incidence in Controls
<b>Historical Incidence: Inhalation Studies</b>	
1-Bromopropane (July 2003)	0/50
Diethylamine (August 2003)	0/50
Tetralin (June 2003)	0/50
Vinylidene chloride (June 2005)	1/50
Total (%)	1/200 (0.5%)
Mean ± standard deviation	0.5% ± 1.0%
Range	0%-2%
<b>Overall Historical Incidence: All Routes</b>	
Total (%)	26/699 (3.7)
Mean ± standard deviation	3.7% ± 3.1%
Range	0%-8%

<sup>a</sup> Data as of June 2013

**TABLE A3b**  
**Historical Incidence of Renal Tubule Neoplasms in Control Male F344/N Rats<sup>a</sup>**

Study (Study Start)	Adenoma	Carcinoma	Adenoma or Carcinoma
<b>Historical Incidence: Inhalation Studies</b>			
1-Bromopropane (July 2003)	1/50	0/50	1/50
Diethylamine (August 2003)	0/50	0/50	0/50
Tetralin (June 2003)	0/50	0/50	0/50
Vinylidene chloride (June 2005)	0/50	0/50	0/50
Total (%)	1/200 (0.5%)	0/200	1/200 (0.5%)
Mean ± standard deviation	0.5% ± 1.0%		0.5% ± 1.0%
Range	0%-2%		0%-2%
<b>Overall Historical Incidence: All Routes</b>			
Total (%)	4/697 (0.6%)	1/697 (0.1%)	5/697 (0.7%)
Mean ± standard deviation	0.6% ± 0.9%	0.1% ± 0.5%	0.7% ± 1.3%
Range	0%-2%	0%-2%	0%-4%

<sup>a</sup> Data as of June 2013

**TABLE A4**  
**Summary of the Incidence of Nonneoplastic Lesions in Male Rats in the 2-Year Inhalation Study**  
**of Vinylidene Chloride<sup>a</sup>**

	Chamber Control	25 ppm	50 ppm	100 ppm
<b>Disposition Summary</b>				
Animals initially in study	50	50	50	50
Early deaths				
Moribund	21	15	23	27
Natural deaths	4	8	5	4
Survivors				
Terminal kill	25	27	22	19
Animals examined microscopically	50	50	50	50
<b>Alimentary System</b>				
Esophagus	(50)	(49)	(49)	(50)
Hyperplasia, squamous				1 (2%)
Intestine large, cecum	(48)	(44)	(45)	(46)
Inflammation, acute	1 (2%)	1 (2%)		
Necrosis	1 (2%)			
Arteriole, inflammation			1 (2%)	
Intestine large, colon	(47)	(46)	(47)	(48)
Arteriole, inflammation			1 (2%)	
Intestine large, rectum	(46)	(47)	(46)	(49)
Thrombosis			1 (2%)	
Intestine small, duodenum	(47)	(45)	(45)	(49)
Intestine small, ileum	(47)	(45)	(45)	(47)
Intestine small, jejunum	(47)	(43)	(45)	(47)
Liver	(50)	(50)	(50)	(50)
Angiectasis		2 (4%)		
Basophilic focus	15 (30%)	7 (14%)	5 (10%)	5 (10%)
Clear cell focus	22 (44%)	23 (46%)	19 (38%)	15 (30%)
Cyst			1 (2%)	
Degeneration, cystic	2 (4%)	5 (10%)	7 (14%)	12 (24%)
Eosinophilic focus	3 (6%)	6 (12%)	7 (14%)	5 (10%)
Fatty change, diffuse	4 (8%)	19 (38%)	18 (36%)	26 (52%)
Hepatodiaphragmatic nodule	1 (2%)	1 (2%)	1 (2%)	5 (10%)
Inflammation, acute				1 (2%)
Inflammation, chronic	28 (56%)	46 (92%)	46 (92%)	44 (88%)
Inflammation, chronic active	1 (2%)			
Mixed cell focus	1 (2%)	1 (2%)	8 (16%)	6 (12%)
Necrosis	2 (4%)	6 (12%)	8 (16%)	6 (12%)
Bile duct, hyperplasia	38 (76%)	23 (46%)	16 (32%)	14 (28%)
Bile duct, inflammation, suppurative			1 (2%)	
Mesentery	(16)	(15)	(21)	(23)
Inflammation, chronic active	2 (13%)		1 (5%)	
Fat, necrosis	13 (81%)	10 (67%)	14 (67%)	12 (52%)
Pancreas	(50)	(50)	(50)	(49)
Atrophy	21 (42%)	16 (32%)	25 (50%)	20 (41%)
Basophilic focus	1 (2%)			
Hyperplasia	4 (8%)	5 (10%)	2 (4%)	7 (14%)
Inflammation, chronic active			1 (2%)	1 (2%)
Salivary glands	(50)	(50)	(50)	(50)
Atrophy		1 (2%)		

<sup>a</sup> Number of animals examined microscopically at the site and the number of animals with lesion

**TABLE A4**  
**Summary of the Incidence of Nonneoplastic Lesions in Male Rats in the 2-Year Inhalation Study**  
**of Vinylidene Chloride**

	Chamber Control	25 ppm	50 ppm	100 ppm
<b>Alimentary System</b> (continued)				
Stomach, forestomach	(50)	(50)	(50)	(50)
Hyperplasia, squamous		2 (4%)	2 (4%)	1 (2%)
Inflammation, chronic active		2 (4%)		
Mineralization	1 (2%)			
Ulcer	4 (8%)	3 (6%)	1 (2%)	6 (12%)
Stomach, glandular	(49)	(50)	(49)	(50)
Mineralization	1 (2%)		1 (2%)	
Necrosis			3 (6%)	3 (6%)
Ulcer			1 (2%)	1 (2%)
Tongue	(0)	(1)	(0)	(2)
Hyperplasia, squamous				2 (100%)
Tooth	(1)	(0)	(0)	(0)
Dysplasia	1 (100%)			
<b>Cardiovascular System</b>				
Blood vessel	(1)	(0)	(1)	(0)
Aorta, mineralization	1 (100%)		1 (100%)	
Heart	(50)	(50)	(50)	(50)
Cardiomyopathy	42 (84%)	41 (82%)	39 (78%)	35 (70%)
Inflammation, chronic active		1 (2%)		
Mineralization	1 (2%)			
Thrombosis	3 (6%)	3 (6%)	6 (12%)	8 (16%)
<b>Endocrine System</b>				
Adrenal cortex	(49)	(50)	(49)	(50)
Hyperplasia	26 (53%)	27 (54%)	27 (55%)	27 (54%)
Hypertrophy	1 (2%)	2 (4%)	2 (4%)	4 (8%)
Necrosis		2 (4%)		
Adrenal medulla	(49)	(50)	(48)	(50)
Hyperplasia	25 (51%)	22 (44%)	17 (35%)	29 (58%)
Bilateral, hyperplasia			1 (2%)	
Islets, pancreatic	(50)	(50)	(50)	(49)
Hyperplasia	1 (2%)	3 (6%)	3 (6%)	3 (6%)
Parathyroid gland	(50)	(49)	(47)	(45)
Hyperplasia	1 (2%)	2 (4%)	1 (2%)	2 (4%)
Pituitary gland	(50)	(49)	(49)	(50)
Angiectasis				1 (2%)
Pars distalis, angiectasis	2 (4%)			1 (2%)
Pars distalis, hemorrhage		1 (2%)		
Pars distalis, hyperplasia	10 (20%)	13 (27%)	14 (29%)	9 (18%)
Pars intermedia, angiectasis	1 (2%)			
Pars intermedia, hyperplasia	1 (2%)			
Thyroid gland	(50)	(49)	(49)	(48)
C-cell, hyperplasia	15 (30%)	16 (33%)	19 (39%)	19 (40%)
Follicular cell, hyperplasia	2 (4%)		2 (4%)	1 (2%)
<b>General Body System</b>				
Peritoneum	(0)	(2)	(4)	(3)
Mesothelium, hyperplasia		1 (50%)		
Tissue, NOS	(0)	(0)	(0)	(1)

**TABLE A4**  
**Summary of the Incidence of Nonneoplastic Lesions in Male Rats in the 2-Year Inhalation Study**  
**of Vinylidene Chloride**

	Chamber Control	25 ppm	50 ppm	100 ppm
<b>Genital System</b>				
Coagulating gland	(0)	(0)	(0)	(3)
Hyperplasia				2 (67%)
Inflammation, suppurative				1 (33%)
Epididymis	(50)	(50)	(50)	(50)
Degeneration				1 (2%)
Granuloma sperm		1 (2%)		
Hyperplasia, mesothelium		3 (6%)	1 (2%)	
Penis	(0)	(0)	(1)	(0)
Inflammation, suppurative			1 (100%)	
Preputial gland	(50)	(49)	(49)	(50)
Hyperplasia	1 (2%)	1 (2%)		
Prostate	(50)	(50)	(50)	(50)
Hyperplasia	5 (10%)	4 (8%)	7 (14%)	5 (10%)
Inflammation, suppurative	4 (8%)	5 (10%)	9 (18%)	8 (16%)
Seminal vesicle	(48)	(50)	(48)	(48)
Hyperplasia			1 (2%)	
Testes	(50)	(50)	(50)	(50)
Atrophy	9 (18%)	10 (20%)	13 (26%)	4 (8%)
Hemorrhage	1 (2%)	1 (2%)		
Hyperplasia, mesothelium		2 (4%)		
Arteriole, inflammation		1 (2%)	1 (2%)	
Interstitial cell, hyperplasia	4 (8%)	4 (8%)	6 (12%)	3 (6%)
Tunic, hyperplasia		2 (4%)	2 (4%)	2 (4%)
<b>Hematopoietic System</b>				
Bone marrow	(49)	(49)	(48)	(49)
Hyperplasia, reticulum cell	1 (2%)			
Lymph node	(6)	(4)	(9)	(7)
Pancreatic, congestion			1 (11%)	
Pancreatic, hyperplasia, lymphoid	1 (17%)			1 (14%)
Pancreatic, infiltration cellular, histiocyte			1 (11%)	
Lymph node, bronchial	(8)	(9)	(9)	(9)
Congestion			1 (11%)	
Ectasia		1 (11%)	2 (22%)	
Hyperplasia, lymphoid	1 (13%)			
Infiltration cellular, histocyte				1 (11%)
Lymph node, mandibular	(1)	(1)	(1)	(0)
Lymph node, mediastinal	(28)	(21)	(24)	(30)
Congestion			1 (4%)	
Ectasia	1 (4%)			
Hyperplasia, lymphoid	2 (7%)		2 (8%)	2 (7%)
Lymph node, mesenteric	(50)	(50)	(50)	(50)
Congestion			1 (2%)	
Ectasia				1 (2%)
Hyperplasia, lymphoid	1 (2%)		1 (2%)	1 (2%)
Inflammation, granulomatous				1 (2%)
Spleen	(50)	(50)	(50)	(50)
Fibrosis	3 (6%)		2 (4%)	4 (8%)
Hematopoietic cell proliferation	3 (6%)	1 (2%)	1 (2%)	
Hyperplasia, lymphoid				1 (2%)
Hyperplasia, stromal	1 (2%)			
Necrosis		1 (2%)	2 (4%)	2 (4%)
Capsule, hyperplasia			1 (2%)	
Thymus	(42)	(43)	(41)	(44)
Infiltration cellular, polymorphonuclear				1 (2%)

**TABLE A4**  
**Summary of the Incidence of Nonneoplastic Lesions in Male Rats in the 2-Year Inhalation Study**  
**of Vinylidene Chloride**

	Chamber Control	25 ppm	50 ppm	100 ppm
<b>Integumentary System</b>				
Mammary gland	(36)	(29)	(24)	(32)
Hyperplasia		1 (3%)		
Skin	(50)	(50)	(49)	(50)
Cyst epithelial inclusion	4 (8%)	2 (4%)	2 (4%)	
Hyperkeratosis		1 (2%)		
Hyperplasia, squamous	1 (2%)			
Inflammation, acute			1 (2%)	
Inflammation, chronic active	2 (4%)		1 (2%)	
<b>Musculoskeletal System</b>				
Bone	(50)	(50)	(50)	(50)
Skeletal muscle	(3)	(4)	(7)	(11)
<b>Nervous System</b>				
Brain	(50)	(50)	(50)	(50)
Hemorrhage	1 (2%)			
Peripheral nerve	(2)	(0)	(1)	(0)
Spinal cord	(2)	(0)	(1)	(0)
<b>Respiratory System</b>				
Larynx	(50)	(49)	(49)	(49)
Inflammation, chronic active	1 (2%)	1 (2%)		1 (2%)
Metaplasia, squamous				1 (2%)
Lung	(50)	(50)	(50)	(50)
Foreign body	1 (2%)			
Inflammation, acute		1 (2%)		
Inflammation, chronic active	2 (4%)		1 (2%)	
Metaplasia, osseous				1 (2%)
Mineralization	1 (2%)		1 (2%)	
Thrombosis	1 (2%)	1 (2%)	2 (4%)	
Alveolar epithelium, hyperplasia	7 (14%)	18 (36%)	14 (28%)	14 (28%)
Alveolar epithelium, metaplasia, squamous			1 (2%)	
Alveolar epithelium, metaplasia, mucous			1 (2%)	
Mediastinum, inflammation, granulomatous	1 (2%)			
Nose	(49)	(50)	(50)	(50)
Foreign body	2 (4%)	2 (4%)	2 (4%)	5 (10%)
Hyperplasia				1 (2%)
Inflammation, acute	2 (4%)			
Inflammation, chronic active	9 (18%)	36 (72%)	45 (90%)	48 (96%)
Thrombosis	4 (8%)	4 (8%)	11 (22%)	7 (14%)
Olfactory epithelium, metaplasia, respiratory	3 (6%)	49 (98%)	49 (98%)	48 (96%)
Olfactory epithelium, metaplasia, squamous			1 (2%)	5 (10%)
Respiratory epithelium, hyperplasia	5 (10%)	8 (16%)	22 (44%)	31 (62%)
Respiratory epithelium, metaplasia, squamous			1 (2%)	3 (6%)
Turbinates, atrophy		50 (100%)	50 (100%)	50 (100%)
Turbinates, hyperostosis		49 (98%)	50 (100%)	50 (100%)
Pleura	(0)	(1)	(0)	(1)
Hyperplasia				1 (100%)
Infiltration cellular, mononuclear cell				1 (100%)
Trachea	(50)	(49)	(49)	(48)

**TABLE A4**  
**Summary of the Incidence of Nonneoplastic Lesions in Male Rats in the 2-Year Inhalation Study**  
**of Vinylidene Chloride**

	Chamber Control	25 ppm	50 ppm	100 ppm
<b>Special Senses System</b>				
Eye	(48)	(48)	(47)	(49)
Cataract	3 (6%)	1 (2%)	1 (2%)	1 (2%)
Degeneration		1 (2%)		1 (2%)
Cornea, inflammation, acute	1 (2%)	1 (2%)		
Cornea, inflammation, chronic active	1 (2%)			1 (2%)
Retina, atrophy	2 (4%)		1 (2%)	1 (2%)
Harderian gland	(50)	(49)	(48)	(49)
Degeneration				1 (2%)
Hyperplasia		2 (4%)	1 (2%)	
Zymbal's gland	(0)	(1)	(0)	(0)
<b>Urinary System</b>				
Kidney	(50)	(50)	(49)	(50)
Cyst		1 (2%)		
Hydronephrosis		1 (2%)		
Infarct			1 (2%)	2 (4%)
Inflammation, suppurative		2 (4%)	1 (2%)	2 (4%)
Mineralization	1 (2%)			
Nephropathy	50 (100%)	47 (94%)	47 (96%)	47 (94%)
Thrombosis		1 (2%)		
Renal tubule, hyperplasia		1 (2%)	1 (2%)	1 (2%)
Renal tubule, necrosis			2 (4%)	
Transitional epithelium, hyperplasia			1 (2%)	2 (4%)
Urinary bladder	(49)	(50)	(49)	(50)
Inflammation, acute				1 (2%)
Inflammation, chronic active			1 (2%)	
Transitional epithelium, hyperplasia			1 (2%)	2 (4%)





**APPENDIX B**  
**SUMMARY OF LESIONS IN FEMALE RATS**  
**IN THE 2-YEAR INHALATION STUDY**  
**OF VINYLIDENE CHLORIDE**

<b>TABLE B1</b>	<b>Summary of the Incidence of Neoplasms in Female Rats in the 2-Year Inhalation Study of Vinylidene Chloride .....</b>	<b>B-2</b>
<b>TABLE B2</b>	<b>Statistical Analysis of Primary Neoplasms in Female Rats in the 2-Year Inhalation Study of Vinylidene Chloride .....</b>	<b>B-6</b>
<b>TABLE B3a</b>	<b>Historical Incidence of Thyroid Gland (C-Cell) Neoplasms in Control Female F344/N Rats.....</b>	<b>B-10</b>
<b>TABLE B3b</b>	<b>Historical Incidence of Mononuclear Cell Leukemia in Control Female F344/N Rats.....</b>	<b>B-10</b>
<b>TABLE B3c</b>	<b>Historical Incidence of Adenoma of the Nose in Control Female F344/N Rats .....</b>	<b>B-11</b>
<b>TABLE B4</b>	<b>Summary of the Incidence of Nonneoplastic Lesions in Female Rats in the 2-Year Inhalation Study of Vinylidene Chloride .....</b>	<b>B-12</b>

**TABLE B1**  
**Summary of the Incidence of Neoplasms in Female Rats in the 2-Year Inhalation Study**  
**of Vinylidene Chloride<sup>a</sup>**

	Chamber Control	25 ppm	50 ppm	100 ppm
<b>Disposition Summary</b>				
Animals initially in study	50	50	50	50
Early deaths				
Moribund	19	22	18	28
Natural deaths	1	2	2	3
Survivors				
Died last week of study			1	
Terminal kill	30	26	29	19
Animals examined microscopically	50	50	50	50
<b>Alimentary System</b>				
Esophagus	(50)	(50)	(50)	(50)
Intestine large, cecum	(49)	(48)	(48)	(48)
Intestine large, colon	(50)	(49)	(48)	(50)
Intestine large, rectum	(49)	(50)	(49)	(49)
Adenoma			1 (2%)	
Leiomyosarcoma, metastatic, vagina		1 (2%)		
Intestine small, duodenum	(50)	(50)	(49)	(50)
Intestine small, ileum	(50)	(48)	(49)	(49)
Intestine small, jejunum	(50)	(48)	(49)	(49)
Liver	(50)	(50)	(50)	(50)
Hepatocellular adenoma	1 (2%)		1 (2%)	1 (2%)
Hepatocellular adenoma, multiple				1 (2%)
Sarcoma, metastatic, uncertain primary site	1 (2%)			
Mesentery	(13)	(20)	(23)	(24)
Oral mucosa	(0)	(1)	(0)	(1)
Squamous cell papilloma		1 (100%)		
Pancreas	(50)	(50)	(50)	(50)
Acinus, adenoma		1 (2%)		
Salivary glands	(50)	(50)	(50)	(50)
Schwannoma malignant, metastatic, heart		1 (2%)		
Stomach, forestomach	(50)	(50)	(50)	(50)
Stomach, glandular	(50)	(50)	(50)	(50)
Tongue	(1)	(0)	(0)	(0)
Squamous cell papilloma	1 (100%)			
<b>Cardiovascular System</b>				
Blood vessel	(1)	(1)	(0)	(0)
Leiomyosarcoma	1 (100%)			
Aorta, schwannoma malignant, metastatic, heart		1 (100%)		
Heart	(50)	(50)	(50)	(50)
Schwannoma malignant		1 (2%)		
<b>Endocrine System</b>				
Adrenal cortex	(50)	(50)	(50)	(50)
Adenoma	1 (2%)	3 (6%)	1 (2%)	1 (2%)
Carcinoma	1 (2%)	1 (2%)		
Bilateral, adenoma	1 (2%)			
Adrenal medulla	(50)	(50)	(50)	(49)
Pheochromocytoma benign		5 (10%)	1 (2%)	1 (2%)
Pheochromocytoma malignant	1 (2%)		2 (4%)	
Bilateral, pheochromocytoma benign			1 (2%)	1 (2%)

**TABLE B1**  
**Summary of the Incidence of Neoplasms in Female Rats in the 2-Year Inhalation Study**  
**of Vinylidene Chloride**

	Chamber Control	25 ppm	50 ppm	100 ppm
<b>Endocrine System</b> (continued)				
Islets, pancreatic	(50)	(50)	(50)	(50)
Adenoma			1 (2%)	1 (2%)
Carcinoma		1 (2%)	1 (2%)	
Parathyroid gland	(49)	(46)	(45)	(47)
Adenoma		1 (2%)		
Pituitary gland	(50)	(49)	(49)	(49)
Pars distalis, adenoma	32 (64%)	36 (73%)	25 (51%)	28 (57%)
Pars distalis, carcinoma	1 (2%)	2 (4%)		1 (2%)
Thyroid gland	(50)	(50)	(48)	(50)
Schwannoma malignant, metastatic, heart		1 (2%)		
C-cell, adenoma	3 (6%)	4 (8%)	6 (13%)	11 (22%)
C-cell, carcinoma		6 (12%)	2 (4%)	2 (4%)
Follicular cell, adenoma		2 (4%)		1 (2%)
<b>General Body System</b>				
Peritoneum	(0)	(1)	(1)	(1)
<b>Genital System</b>				
Clitoral gland	(47)	(48)	(45)	(48)
Adenoma	4 (9%)	8 (17%)	3 (7%)	4 (8%)
Carcinoma	1 (2%)			5 (10%)
Ovary	(50)	(50)	(50)	(50)
Granulosa cell tumor benign		1 (2%)		
Granulosa cell tumor malignant			1 (2%)	
Granulosa-theca tumor benign		1 (2%)		
Granulosa-theca tumor malignant	1 (2%)			
Sertoli cell tumor malignant	1 (2%)			
Yolk sac carcinoma			1 (2%)	
Uterus	(50)	(50)	(50)	(50)
Polyp stromal	10 (20%)	9 (18%)	4 (8%)	8 (16%)
Sarcoma stromal			2 (4%)	
Bilateral, polyp stromal	1 (2%)			
Endometrium, carcinoma			1 (2%)	1 (2%)
Vagina	(0)	(2)	(0)	(1)
Granulosa cell tumor benign		1 (50%)		
Leiomyosarcoma		1 (50%)		
Polyp				1 (100%)
<b>Hematopoietic System</b>				
Bone marrow	(50)	(50)	(50)	(50)
Lymph node	(2)	(2)	(4)	(9)
Lymph node, bronchial	(4)	(7)	(4)	(10)
Lymph node, mandibular	(2)	(0)	(1)	(4)
Lymph node, mediastinal	(33)	(26)	(29)	(38)
Carcinoma, metastatic, thyroid gland		1 (4%)		
Lymph node, mesenteric	(50)	(50)	(50)	(50)
Spleen	(50)	(50)	(50)	(50)
Schwannoma malignant, metastatic, heart		1 (2%)		
Thymus	(46)	(45)	(42)	(42)
Sarcoma, metastatic, uncertain primary site	1 (2%)			
Thymoma benign		1 (2%)		
Thymoma malignant			1 (2%)	

**TABLE B1**  
**Summary of the Incidence of Neoplasms in Female Rats in the 2-Year Inhalation Study**  
**of Vinylidene Chloride**

	Chamber Control	25 ppm	50 ppm	100 ppm
<b>Integumentary System</b>				
Mammary gland	(50)	(50)	(50)	(50)
Carcinoma	4 (8%)		2 (4%)	4 (8%)
Carcinoma, multiple	1 (2%)	1 (2%)		
Fibroadenoma	26 (52%)	18 (36%)	21 (42%)	25 (50%)
Fibroadenoma, multiple	11 (22%)	16 (32%)	10 (20%)	14 (28%)
Schwannoma malignant, metastatic, heart		1 (2%)		
Skin	(50)	(50)	(50)	(50)
Basal cell, adenoma	1 (2%)	1 (2%)		
Keratoacanthoma	1 (2%)		1 (2%)	
Subcutaneous tissue, fibroma	1 (2%)	2 (4%)	2 (4%)	
Subcutaneous tissue, neural crest tumor		1 (2%)		
Subcutaneous tissue, sarcoma			1 (2%)	
Subcutaneous tissue, schwannoma malignant		1 (2%)		
<b>Musculoskeletal System</b>				
Bone	(50)	(50)	(50)	(50)
Chondroma			1 (2%)	
Osteoma		1 (2%)		
Osteosarcoma	1 (2%)			
Sarcoma, metastatic, uncertain primary site	1 (2%)			
Skeletal muscle	(1)	(2)	(3)	(0)
Sarcoma			1 (33%)	
Sarcoma, metastatic, uncertain primary site	1 (100%)			
Schwannoma malignant, metastatic, heart		1 (50%)		
<b>Nervous System</b>				
Brain	(50)	(50)	(50)	(50)
Carcinoma, metastatic, pituitary gland	1 (2%)	2 (4%)		1 (2%)
Oligodendreglioma benign		1 (2%)		
Oligodendreglioma malignant				1 (2%)
<b>Respiratory System</b>				
Larynx	(50)	(50)	(50)	(50)
Schwannoma malignant, metastatic, heart		1 (2%)		
Lung	(50)	(50)	(50)	(50)
Alveolar/bronchiolar adenoma	1 (2%)		4 (8%)	
Alveolar/bronchiolar carcinoma, multiple				1 (2%)
Mesenchymal tumor malignant, metastatic, kidney		1 (2%)		
Pheochromocytoma malignant, metastatic, adrenal medulla	1 (2%)		1 (2%)	
Sarcoma, metastatic, skeletal muscle			1 (2%)	
Sarcoma, metastatic, uncertain primary site	1 (2%)			
Schwannoma malignant, metastatic, heart		1 (2%)		

**TABLE B1**  
**Summary of the Incidence of Neoplasms in Female Rats in the 2-Year Inhalation Study**  
**of Vinylidene Chloride**

	Chamber Control	25 ppm	50 ppm	100 ppm
<b>Respiratory System</b> (continued)				
Nose	(50)	(50)	(50)	(50)
Chondroma				1 (2%)
Respiratory epithelium, adenoma				1 (2%)
Pleura	(0)	(1)	(0)	(1)
Trachea	(50)	(50)	(50)	(50)
Schwannoma malignant, metastatic, heart		1 (2%)		
<b>Special Senses System</b>				
Eye	(50)	(49)	(50)	(49)
Harderian gland	(50)	(50)	(50)	(50)
Schwannoma malignant, metastatic, heart		1 (2%)		
Lacrimal gland	(0)	(0)	(1)	(1)
Zymbal's gland	(0)	(0)	(1)	(0)
Carcinoma			1 (100%)	
<b>Urinary System</b>				
Kidney	(50)	(50)	(50)	(50)
Mesenchymal tumor malignant		1 (2%)		
Schwannoma malignant, metastatic, heart		1 (2%)		
Renal tubule, adenoma			1 (2%)	
Urinary bladder	(50)	(50)	(50)	(50)
Leiomyosarcoma, metastatic, vagina		1 (2%)		
<b>Systemic Lesions</b>				
Multiple organs <sup>b</sup>	(50)	(50)	(50)	(50)
Histiocytic sarcoma				1 (2%)
Leukemia mononuclear	10 (20%)	11 (22%)	13 (26%)	25 (50%)
Lymphoma malignant	1 (2%)			1 (2%)
Mesothelioma malignant		1 (2%)	1 (2%)	
<b>Neoplasm Summary</b>				
Total animals with primary neoplasms <sup>c</sup>	49	49	47	49
Total primary neoplasms	119	141	114	142
Total animals with benign neoplasms	47	47	44	45
Total benign neoplasms	94	113	84	100
Total animals with malignant neoplasms	23	25	26	38
Total malignant neoplasms	25	27	30	42
Total animals with metastatic neoplasms	3	6	2	1
Total metastatic neoplasms	7	17	2	1
Total animals with malignant neoplasms of uncertain primary site	1			
Total animals with uncertain neoplasms- benign or malignant		1		
Total uncertain neoplasms		1		

<sup>a</sup> Number of animals examined microscopically at the site and the number of animals with neoplasm

<sup>b</sup> Number of animals with any tissue examined microscopically

<sup>c</sup> Primary neoplasms: all neoplasms except metastatic neoplasms

**TABLE B2**  
**Statistical Analysis of Primary Neoplasms in Female Rats in the 2-Year Inhalation Study**  
**of Vinylidene Chloride**

	Chamber Control	25 ppm	50 ppm	100 ppm
<b>Adrenal Cortex: Adenoma</b>				
Overall rate <sup>a</sup>	2/50 (4%)	3/50 (6%)	1/50 (2%)	1/50 (2%)
Adjusted rate <sup>b</sup>	4.4%	7.2%	2.4%	2.4%
Terminal rate <sup>c</sup>	2/30 (7%)	3/26 (12%)	1/29 (3%)	0/19 (0%)
First incidence (days)	731 (T)	731 (T)	731 (T)	670
Poly-3 test <sup>d</sup>	P=0.307N	P=0.462	P=0.531N	P=0.530N
<b>Adrenal Medulla: Benign Pheochromocytoma</b>				
Overall rate	0/50 (0%)	5/50 (10%)	2/50 (4%)	2/49 (4%)
Adjusted rate	0.0%	12.0%	4.8%	4.9%
Terminal rate	0/30 (0%)	5/26 (19%)	2/29 (7%)	2/19 (11%)
First incidence (days)	— <sup>e</sup>	731 (T)	731 (T)	731 (T)
Poly-3 test	P=0.411	P=0.024	P=0.218	P=0.216
<b>Adrenal Medulla: Benign or Malignant Pheochromocytoma</b>				
Overall rate	1/50 (2%)	5/50 (10%)	3/50 (6%)	2/49 (4%)
Adjusted rate	2.2%	12.0%	7.2%	4.9%
Terminal rate	1/30 (3%)	5/26 (19%)	2/29 (7%)	2/19 (11%)
First incidence (days)	731 (T)	731 (T)	715	731 (T)
Poly-3 test	P=0.541	P=0.083	P=0.275	P=0.467
<b>Clitoral Gland: Adenoma</b>				
Overall rate	4/47 (9%)	8/48 (17%)	3/45 (7%)	4/48 (8%)
Adjusted rate	9.4%	19.8%	7.9%	10.0%
Terminal rate	3/28 (11%)	6/24 (25%)	3/26 (12%)	0/18 (0%)
First incidence (days)	724	535	731 (T)	670
Poly-3 test	P=0.401N	P=0.151	P=0.564N	P=0.613
<b>Clitoral Gland: Carcinoma</b>				
Overall rate	1/47 (2%)	0/48 (0%)	0/45 (0%)	5/48 (10%)
Adjusted rate	2.4%	0.0%	0.0%	12.4%
Terminal rate	1/28 (4%)	0/24 (0%)	0/26 (0%)	3/18 (17%)
First incidence (days)	731 (T)	—	—	579
Poly-3 test	P=0.008	P=0.513N	P=0.523N	P=0.088
<b>Clitoral Gland: Adenoma or Carcinoma</b>				
Overall rate	5/47 (11%)	8/48 (17%)	3/45 (7%)	8/48 (17%)
Adjusted rate	11.8%	19.8%	7.9%	19.7%
Terminal rate	4/28 (14%)	6/24 (25%)	3/26 (12%)	3/18 (17%)
First incidence (days)	724	535	731 (T)	579
Poly-3 test	P=0.294	P=0.243	P=0.422N	P=0.245
<b>Lung: Alveolar/bronchiolar Adenoma</b>				
Overall rate	1/50 (2%)	0/50 (0%)	4/50 (8%)	0/50 (0%)
Adjusted rate	2.2%	0.0%	9.4%	0.0%
Terminal rate	1/30 (3%)	0/26 (0%)	2/29 (7%)	0/19 (0%)
First incidence (days)	731 (T)	—	526	—
Poly-3 test	P=0.564N	P=0.516N	P=0.159	P=0.518N
<b>Lung: Alveolar/bronchiolar Adenoma or Carcinoma</b>				
Overall rate	1/50 (2%)	0/50 (0%)	4/50 (8%)	1/50 (2%)
Adjusted rate	2.2%	0.0%	9.4%	2.4%
Terminal rate	1/30 (3%)	0/26 (0%)	2/29 (7%)	1/19 (5%)
First incidence (days)	731 (T)	—	526	731 (T)
Poly-3 test	P=0.405	P=0.516N	P=0.159	P=0.740

**TABLE B2**  
**Statistical Analysis of Primary Neoplasms in Female Rats in the 2-Year Inhalation Study**  
**of Vinylidene Chloride**

	<b>Chamber Control</b>	<b>25 ppm</b>	<b>50 ppm</b>	<b>100 ppm</b>
<b>Mammary Gland: Fibroadenoma</b>				
Overall rate	37/50 (74%)	34/50 (68%)	31/50 (62%)	39/50 (78%)
Adjusted rate	76.6%	73.8%	68.7%	85.2%
Terminal rate	22/30 (73%)	19/26 (73%)	20/29 (69%)	17/19 (90%)
First incidence (days)	547	541	423	607
Poly-3 test	P=0.167	P=0.469N	P=0.260N	P=0.198
<b>Mammary Gland: Carcinoma</b>				
Overall rate	5/50 (10%)	1/50 (2%)	2/50 (4%)	4/50 (8%)
Adjusted rate	10.9%	2.4%	4.8%	9.7%
Terminal rate	2/30 (7%)	1/26 (4%)	1/29 (3%)	3/19 (16%)
First incidence (days)	592	731 (T)	726	712
Poly-3 test	P=0.558	P=0.124N	P=0.258N	P=0.564N
<b>Mammary Gland: Fibroadenoma or Carcinoma</b>				
Overall rate	38/50 (76%)	34/50 (68%)	31/50 (62%)	40/50 (80%)
Adjusted rate	77.9%	73.8%	68.7%	87.3%
Terminal rate	22/30 (73%)	19/26 (73%)	20/29 (69%)	17/19 (90%)
First incidence (days)	547	541	423	607
Poly-3 test	P=0.135	P=0.408N	P=0.212N	P=0.163
<b>Pituitary Gland (Pars Distalis): Adenoma</b>				
Overall rate	32/50 (64%)	36/49 (73%)	25/49 (51%)	28/49 (57%)
Adjusted rate	66.1%	79.4%	57.3%	63.3%
Terminal rate	18/30 (60%)	20/25 (80%)	16/29 (55%)	11/19 (58%)
First incidence (days)	551	535	514	642
Poly-3 test	P=0.215N	P=0.105	P=0.252N	P=0.473N
<b>Pituitary Gland (Pars Distalis): Adenoma or Carcinoma</b>				
Overall rate	33/50 (66%)	38/49 (78%)	25/49 (51%)	29/49 (59%)
Adjusted rate	68.1%	83.0%	57.3%	65.5%
Terminal rate	18/30 (60%)	20/25 (80%)	16/29 (55%)	12/19 (63%)
First incidence (days)	551	535	514	642
Poly-3 test	P=0.191N	P=0.067	P=0.189N	P=0.482N
<b>Skin (Subcutaneous Tissue): Fibroma or Sarcoma</b>				
Overall rate	1/50 (2%)	2/50 (4%)	3/50 (6%)	0/50 (0%)
Adjusted rate	2.2%	4.7%	7.2%	0.0%
Terminal rate	1/30 (3%)	1/26 (4%)	3/29 (10%)	0/19 (0%)
First incidence (days)	731 (T)	613	731 (T)	—
Poly-3 test	P=0.378N	P=0.475	P=0.274	P=0.518N
<b>Thyroid Gland (C-Cell): Adenoma</b>				
Overall rate	3/50 (6%)	4/50 (8%)	6/48 (13%)	11/50 (22%)
Adjusted rate	6.6%	9.5%	14.6%	26.2%
Terminal rate	3/30 (10%)	2/26 (8%)	4/28 (14%)	6/19 (32%)
First incidence (days)	731 (T)	625	579	669
Poly-3 test	P=0.004	P=0.461	P=0.195	P=0.012
<b>Thyroid Gland (C-Cell): Carcinoma</b>				
Overall rate	0/50 (0%)	6/50 (12%)	2/48 (4%)	2/50 (4%)
Adjusted rate	0.0%	14.4%	4.9%	4.8%
Terminal rate	0/30 (0%)	6/26 (23%)	1/28 (4%)	1/19 (5%)
First incidence (days)	—	731 (T)	670	670
Poly-3 test	P=0.474	P=0.011	P=0.213	P=0.218



**TABLE B2**  
**Statistical Analysis of Primary Neoplasms in Female Rats in the 2-Year Inhalation Study**  
**of Vinylidene Chloride**

	<b>Chamber Control</b>	<b>25 ppm</b>	<b>50 ppm</b>	<b>100 ppm</b>
<b>Thyroid Gland (C-Cell): Adenoma or Carcinoma</b>				
Overall rate	3/50 (6%)	10/50 (20%)	8/48 (17%)	13/50 (26%)
Adjusted rate	6.6%	23.7%	19.3%	30.8%
Terminal rate	3/30 (10%)	8/26 (31%)	5/28 (18%)	7/19 (37%)
First incidence (days)	731 (T)	625	579	669
Poly-3 test	P=0.006	P=0.023	P=0.071	P=0.003
<b>Uterus: Stromal Polyp</b>				
Overall rate	11/50 (22%)	9/50 (18%)	4/50 (8%)	8/50 (16%)
Adjusted rate	23.7%	20.9%	9.4%	18.9%
Terminal rate	8/30 (27%)	5/26 (19%)	2/29 (7%)	5/19 (26%)
First incidence (days)	579	610	514	567
Poly-3 test	P=0.258N	P=0.475N	P=0.062N	P=0.385N
<b>Uterus: Stromal Polyp or Stromal Sarcoma</b>				
Overall rate	11/50 (22%)	9/50 (18%)	6/50 (12%)	8/50 (16%)
Adjusted rate	23.7%	20.9%	13.9%	18.9%
Terminal rate	8/30 (27%)	5/26 (19%)	3/29 (10%)	5/19 (26%)
First incidence (days)	579	610	514	567
Poly-3 test	P=0.290N	P=0.475N	P=0.179N	P=0.385N
<b>All Organs: Mononuclear Cell Leukemia</b>				
Overall rate	10/50 (20%)	11/50 (22%)	13/50 (26%)	25/50 (50%)
Adjusted rate	21.4%	24.6%	28.3%	54.6%
Terminal rate	3/30 (10%)	4/26 (15%)	3/29 (10%)	8/19 (42%)
First incidence (days)	631	451	421	395
Poly-3 test	P<0.001	P=0.457	P=0.300	P<0.001
<b>All Organs: Benign Neoplasms</b>				
Overall rate	47/50 (94%)	47/50 (94%)	44/50 (88%)	45/50 (90%)
Adjusted rate	94.9%	98.0%	90.7%	96.0%
Terminal rate	29/30 (97%)	26/26 (100%)	26/29 (90%)	19/19 (100%)
First incidence (days)	547	535	423	567
Poly-3 test	P=0.541N	P=0.380	P=0.325N	P=0.612

**TABLE B2**  
**Statistical Analysis of Primary Neoplasms in Female Rats in the 2-Year Inhalation Study**  
**of Vinylidene Chloride**

	<b>Chamber Control</b>	<b>25 ppm</b>	<b>50 ppm</b>	<b>100 ppm</b>
<b>All Organs: Malignant Neoplasms</b>				
Overall rate	24/50 (48%)	25/50 (50%)	26/50 (52%)	38/50 (76%)
Adjusted rate	49.3%	53.7%	55.1%	80.3%
Terminal rate	8/30 (27%)	13/26 (50%)	12/29 (41%)	15/19 (79%)
First incidence (days)	547	451	421	395
Poly-3 test	P<0.001	P=0.413	P=0.361	P<0.001
<b>All Organs: Benign or Malignant Neoplasms</b>				
Overall rate	49/50 (98%)	49/50 (98%)	47/50 (94%)	49/50 (98%)
Adjusted rate	98.0%	99.0%	94.4%	100.0%
Terminal rate	29/30 (97%)	26/26 (100%)	27/29 (93%)	19/19 (100%)
First incidence (days)	547	451	421	395
Poly-3 test	P=0.452	P=0.669	P=0.338N	P=0.506

(T) Terminal kill

- <sup>a</sup> Number of neoplasm-bearing animals/number of animals examined. Denominator is number of animals examined microscopically for adrenal gland, clitoral gland, lung, pituitary gland, and thyroid gland; for other tissues, denominator is number of animals necropsied.
- <sup>b</sup> Poly-3 estimated neoplasm incidence after adjustment for intercurrent mortality
- <sup>c</sup> Observed incidence at terminal kill
- <sup>d</sup> Beneath the chamber control incidence is the P value associated with the trend test. Beneath the exposed group incidence are the P values corresponding to pairwise comparisons between the chamber controls and that exposed group. The Poly-3 test accounts for differential mortality in animals that do not reach terminal kill. A negative trend or a lower incidence in an exposure group is indicated by N.
- <sup>e</sup> Not applicable; no neoplasms in animal group

**TABLE B3a**  
**Historical Incidence of Thyroid Gland (C-Cell) Neoplasms in Control Female F344/N Rats<sup>a</sup>**

Study (Study Start)	Adenoma	Carcinoma	Adenoma or Carcinoma
<b>Historical Incidence: Inhalation Studies</b>			
1-Bromopropane (July 2003)	3/50	1/50	4/50
Diethylamine (August 2003)	4/50	0/50	4/50
Tetralin (June 2003)	3/50	0/50	3/50
Vinylidene chloride (June 2005)	3/50	0/50	3/50
Total (%)	13/200 (6.5%)	1/200 (0.5%)	14/200 (7.0%)
Mean ± standard deviation	6.5% ± 1.0%	0.5% ± 1.0%	7.0% ± 1.2%
Range	6%-8%	0%-2%	6%-8%
<b>Overall Historical Incidence: All Routes</b>			
Total (%)	81/690 (11.7%)	6/690 (0.9%)	87/690 (12.6%)
Mean ± standard deviation	11.7% ± 5.5%	0.9% ± 2.0%	12.7% ± 5.8%
Range	6%-22%	0%-7%	6%-22%

<sup>a</sup> Data as of June 2013

**TABLE B3b**  
**Historical Incidence of Mononuclear Cell Leukemia in Control Female F344/N Rats<sup>a</sup>**

Study (Study Start)	Incidence in Controls
<b>Historical Incidence: Inhalation Studies</b>	
1-Bromopropane (July 2003)	16/50
Diethylamine (August 2003)	15/50
Tetralin (June 2003)	17/50
Vinylidene chloride (June 2005)	10/50
Total (%)	58/200 (29.0%)
Mean ± standard deviation	29.0% ± 6.2%
Range	20%-34%
<b>Overall Historical Incidence: All Routes</b>	
Total (%)	165/700 (23.6%)
Mean ± standard deviation	23.6% ± 8.2%
Range	10%-36%

<sup>a</sup> Data as of June 2013

**TABLE B3c**  
**Historical Incidence of Adenoma of the Nose in Control Female F344/N Rats<sup>a</sup>**

Study (Study Start)	Incidence in Controls
<b>Historical Incidence: Inhalation Studies</b>	
1-Bromopropane (July 2003)	0/50
Diethylamine (August 2003)	0/50
Tetralin (June 2003)	0/50
Vinylidene chloride (June 2005)	0/50
Total (%)	0/200
<b>Overall Historical Incidence: All Routes</b>	
Total (%)	1/697 (0.1%)
Mean $\pm$ standard deviation	0.1% $\pm$ 0.5%
Range	0%-2%

<sup>a</sup> Data as of June 2013

**TABLE B4**  
**Summary of the Incidence of Nonneoplastic Lesions in Female Rats in the 2-Year Inhalation Study**  
**of Vinylidene Chloride<sup>a</sup>**

	Chamber Control	25 ppm	50 ppm	100 ppm
<b>Disposition Summary</b>				
Animals initially in study	50	50	50	50
Early deaths				
Moribund	19	22	18	28
Natural deaths	1	2	2	3
Survivors				
Died last week of study			1	
Terminal kill	30	26	29	19
Animals examined microscopically	50	50	50	50
<b>Alimentary System</b>				
Esophagus	(50)	(50)	(50)	(50)
Intestine large, cecum	(49)	(48)	(48)	(48)
Intestine large, colon	(50)	(49)	(48)	(50)
Cyst			1 (2%)	
Intestine large, rectum	(49)	(50)	(49)	(49)
Intestine small, duodenum	(50)	(50)	(49)	(50)
Intestine small, ileum	(50)	(48)	(49)	(49)
Intestine small, jejunum	(50)	(48)	(49)	(49)
Liver	(50)	(50)	(50)	(50)
Angiectasis	2 (4%)	4 (8%)	4 (8%)	5 (10%)
Basophilic focus	46 (92%)	41 (82%)	32 (64%)	29 (58%)
Clear cell focus	15 (30%)	19 (38%)	22 (44%)	18 (36%)
Degeneration, cystic		2 (4%)	4 (8%)	7 (14%)
Eosinophilic focus	6 (12%)	11 (22%)	7 (14%)	16 (32%)
Fatty change	1 (2%)			
Fatty change, focal	2 (4%)	1 (2%)	3 (6%)	
Fatty change, diffuse	19 (38%)	30 (60%)	26 (52%)	30 (60%)
Fibrosis, focal		1 (2%)		
Hepatodiaphragmatic nodule	3 (6%)	6 (12%)	4 (8%)	5 (10%)
Inflammation, chronic	42 (84%)	48 (96%)	49 (98%)	48 (96%)
Mixed cell focus	4 (8%)	16 (32%)	12 (24%)	13 (26%)
Necrosis		3 (6%)	5 (10%)	11 (22%)
Bile duct, hyperplasia	7 (14%)		1 (2%)	6 (12%)
Mesentery	(13)	(20)	(23)	(24)
Inflammation, chronic active		1 (5%)		
Fat, hemorrhage			1 (4%)	
Fat, necrosis	13 (100%)	19 (95%)	22 (96%)	23 (96%)
Oral mucosa	(0)	(1)	(0)	(1)
Pharyngeal, hyperplasia, squamous				1 (100%)
Pancreas	(50)	(50)	(50)	(50)
Basophilic focus	1 (2%)			
Inflammation, granulomatous			1 (2%)	
Acinus, atrophy	9 (18%)	13 (26%)	11 (22%)	11 (22%)
Acinus, hyperplasia		1 (2%)	3 (6%)	3 (6%)
Salivary glands	(50)	(50)	(50)	(50)
Atrophy				1 (2%)
Basophilic focus			2 (4%)	1 (2%)
Stomach, forestomach	(50)	(50)	(50)	(50)
Hyperplasia, squamous		1 (2%)	2 (4%)	2 (4%)
Necrosis		1 (2%)		
Ulcer	3 (6%)	1 (2%)	1 (2%)	3 (6%)

<sup>a</sup> Number of animals examined microscopically at the site and the number of animals with lesion

**TABLE B4**  
**Summary of the Incidence of Nonneoplastic Lesions in Female Rats in the 2-Year Inhalation Study**  
**of Vinylidene Chloride**

	Chamber Control	25 ppm	50 ppm	100 ppm
<b>Alimentary System</b> (continued)				
Stomach, glandular	(50)	(50)	(50)	(50)
Mineralization		1 (2%)		
Necrosis	1 (2%)	4 (8%)	1 (2%)	6 (12%)
Tongue	(1)	(0)	(0)	(0)
<b>Cardiovascular System</b>				
Blood vessel	(1)	(1)	(0)	(0)
Heart	(50)	(50)	(50)	(50)
Cardiomyopathy	33 (66%)	34 (68%)	32 (64%)	27 (54%)
Thrombosis		1 (2%)		1 (2%)
Pericardium, fibrosis				1 (2%)
<b>Endocrine System</b>				
Adrenal cortex	(50)	(50)	(50)	(50)
Degeneration, cystic				1 (2%)
Hematopoietic cell proliferation		2 (4%)		
Hyperplasia	30 (60%)	28 (56%)	20 (40%)	25 (50%)
Hypertrophy	7 (14%)	3 (6%)	1 (2%)	4 (8%)
Metaplasia, osseous				1 (2%)
Necrosis				1 (2%)
Vacuolization cytoplasmic	1 (2%)			
Adrenal medulla	(50)	(50)	(50)	(49)
Hyperplasia	7 (14%)	10 (20%)	9 (18%)	12 (24%)
Islets, pancreatic	(50)	(50)	(50)	(50)
Hyperplasia		1 (2%)		
Parathyroid gland	(49)	(46)	(45)	(47)
Angiectasis			1 (2%)	
Hyperplasia	1 (2%)			
Pituitary gland	(50)	(49)	(49)	(49)
Pars distalis, angiectasis	4 (8%)	4 (8%)	4 (8%)	1 (2%)
Pars distalis, hyperplasia	12 (24%)	6 (12%)	12 (24%)	11 (22%)
Thyroid gland	(50)	(50)	(48)	(50)
C-cell, hyperplasia	35 (70%)	30 (60%)	32 (67%)	27 (54%)
Follicular cell, hyperplasia		1 (2%)		1 (2%)
<b>General Body System</b>				
Peritoneum	(0)	(1)	(1)	(1)
Inflammation, acute		1 (100%)		
Mesothelium, hyperplasia				1 (100%)
<b>Genital System</b>				
Clitoral gland	(47)	(48)	(45)	(48)
Hyperplasia		4 (8%)	1 (2%)	1 (2%)
Inflammation, chronic active		1 (2%)		
Ovary	(50)	(50)	(50)	(50)
Cyst			1 (2%)	1 (2%)
Bursa, dilatation	5 (10%)	11 (22%)	17 (34%)	24 (48%)
Follicle, cyst			1 (2%)	
Interstitial cell, hyperplasia	1 (2%)			
Periovarian tissue, cyst			1 (2%)	

**TABLE B4**  
**Summary of the Incidence of Nonneoplastic Lesions in Female Rats in the 2-Year Inhalation Study**  
**of Vinylidene Chloride**

	Chamber Control	25 ppm	50 ppm	100 ppm
<b>Genital System (continued)</b>				
Uterus	(50)	(50)	(50)	(50)
Inflammation, chronic active	1 (2%)			
Endometrium, hyperplasia, cystic	1 (2%)	1 (2%)	1 (2%)	1 (2%)
Vagina	(0)	(2)	(0)	(1)
<b>Hematopoietic System</b>				
Bone marrow	(50)	(50)	(50)	(50)
Hyperplasia, reticulum cell	1 (2%)			
Lymph node	(2)	(2)	(4)	(9)
Deep cervical, hemorrhage			1 (25%)	
Deep cervical, hyperplasia, lymphoid			1 (25%)	
Lymph node, bronchial	(4)	(7)	(4)	(10)
Congestion	1 (25%)			
Hyperplasia, lymphoid		1 (14%)		1 (10%)
Infiltration cellular, histiocyte				1 (10%)
Lymph node, mandibular	(2)	(0)	(1)	(4)
Lymph node, mediastinal	(33)	(26)	(29)	(38)
Ectasia	1 (3%)			1 (3%)
Hemorrhage	1 (3%)		1 (3%)	
Hyperplasia, lymphoid	1 (3%)	1 (4%)		
Hyperplasia, plasma cell		1 (4%)		
Lymph node, mesenteric	(50)	(50)	(50)	(50)
Congestion	1 (2%)			
Hyperplasia, lymphoid	1 (2%)	1 (2%)		1 (2%)
Inflammation, granulomatous				1 (2%)
Spleen	(50)	(50)	(50)	(50)
Fibrosis	2 (4%)	1 (2%)	2 (4%)	4 (8%)
Hematopoietic cell proliferation			2 (4%)	1 (2%)
Hemorrhage		1 (2%)		
Hyperplasia, lymphoid		1 (2%)		
Inflammation, granulomatous		1 (2%)		
Inflammation, acute		1 (2%)		
Necrosis				3 (6%)
Thymus	(46)	(45)	(42)	(42)
<b>Integumentary System</b>				
Mammary gland	(50)	(50)	(50)	(50)
Galactocele	1 (2%)	2 (4%)	2 (4%)	
Hyperplasia	1 (2%)	1 (2%)		
Skin	(50)	(50)	(50)	(50)
Cyst epithelial inclusion	1 (2%)			
Hyperkeratosis			1 (2%)	
Inflammation, chronic active		1 (2%)	1 (2%)	1 (2%)
<b>Musculoskeletal System</b>				
Bone	(50)	(50)	(50)	(50)
Hyperostosis			1 (2%)	
Skeletal muscle	(1)	(2)	(3)	(0)
Fibrosis			1 (33%)	

**TABLE B4**  
**Summary of the Incidence of Nonneoplastic Lesions in Female Rats in the 2-Year Inhalation Study**  
**of Vinylidene Chloride**

	Chamber Control	25 ppm	50 ppm	100 ppm
<b>Nervous System</b>				
Brain	(50)	(50)	(50)	(50)
Hydrocephalus		1 (2%)		
Necrosis				1 (2%)
<b>Respiratory System</b>				
Larynx	(50)	(50)	(50)	(50)
Inflammation, chronic active	2 (4%)	2 (4%)	1 (2%)	
Metaplasia, squamous	1 (2%)	3 (6%)		
Lung	(50)	(50)	(50)	(50)
Hemorrhage			1 (2%)	
Inflammation, chronic active	1 (2%)	1 (2%)	1 (2%)	
Thrombosis				1 (2%)
Alveolar epithelium, hyperplasia	12 (24%)	13 (26%)	13 (26%)	8 (16%)
Alveolar epithelium, metaplasia, squamous	1 (2%)		2 (4%)	2 (4%)
Alveolus, infiltration cellular, histiocyte			2 (4%)	1 (2%)
Bronchiole, hyperplasia		2 (4%)	1 (2%)	1 (2%)
Nose	(50)	(50)	(50)	(50)
Foreign body	2 (4%)	4 (8%)		5 (10%)
Inflammation, acute	1 (2%)			
Inflammation, chronic active	7 (14%)	45 (90%)	46 (92%)	46 (92%)
Polyp, inflammatory				3 (6%)
Thrombosis		3 (6%)	2 (4%)	7 (14%)
Olfactory epithelium, metaplasia, respiratory	1 (2%)	50 (100%)	50 (100%)	50 (100%)
Olfactory epithelium, metaplasia, squamous			1 (2%)	1 (2%)
Respiratory epithelium, hyperplasia	4 (8%)	12 (24%)	14 (28%)	27 (54%)
Respiratory epithelium, metaplasia, squamous				3 (6%)
Turbinate, atrophy		50 (100%)	50 (100%)	50 (100%)
Turbinate, hyperostosis		50 (100%)	50 (100%)	50 (100%)
Pleura	(0)	(1)	(0)	(1)
Hyperplasia				1 (100%)
Infiltration cellular, mononuclear cell				1 (100%)
Trachea	(50)	(50)	(50)	(50)
<b>Special Senses System</b>				
Eye	(50)	(49)	(50)	(49)
Cataract	1 (2%)	1 (2%)	3 (6%)	1 (2%)
Degeneration	1 (2%)	3 (6%)	1 (2%)	
Cornea, inflammation, chronic active	1 (2%)			
Retina, atrophy	1 (2%)	4 (8%)	3 (6%)	2 (4%)
Harderian gland	(50)	(50)	(50)	(50)
Hyperplasia	2 (4%)		1 (2%)	
Inflammation, chronic	1 (2%)			
Lacrimal gland	(0)	(0)	(1)	(1)
Cytoplasmic alteration			1 (100%)	
Degeneration				1 (100%)
Zymbal's gland	(0)	(0)	(1)	(0)



**TABLE B4**  
**Summary of the Incidence of Nonneoplastic Lesions in Female Rats in the 2-Year Inhalation Study**  
**of Vinylidene Chloride**

	Chamber Control	25 ppm	50 ppm	100 ppm
<b>Urinary System</b>				
Kidney	(50)	(50)	(50)	(50)
Fibrosis		1 (2%)		
Hydronephrosis	1 (2%)	1 (2%)		
Hyperplasia, oncocytic	1 (2%)		1 (2%)	
Infarct	1 (2%)	1 (2%)		2 (4%)
Mineralization		1 (2%)		
Nephropathy	45 (90%)	40 (80%)	43 (86%)	42 (84%)
Papilla, necrosis		1 (2%)		
Renal tubule, hyperplasia	1 (2%)	2 (4%)		2 (4%)
Renal tubule, necrosis			1 (2%)	
Urinary bladder	(50)	(50)	(50)	(50)
Inflammation, chronic active	1 (2%)			

**APPENDIX C**  
**SUMMARY OF LESIONS IN MALE MICE**  
**IN THE 2-YEAR INHALATION STUDY**  
**OF VINYLIDENE CHLORIDE**

<b>TABLE C1</b>	<b>Summary of the Incidence of Neoplasms in Male Mice in the 2-Year Inhalation Study of Vinylidene Chloride .....</b>	<b>C-2</b>
<b>TABLE C2</b>	<b>Statistical Analysis of Primary Neoplasms in Male Mice in the 2-Year Inhalation Study of Vinylidene Chloride .....</b>	<b>C-7</b>
<b>TABLE C3</b>	<b>Historical Incidence of Renal Tubule Neoplasms in Control Male B6C3F1/N Mice .....</b>	<b>C-11</b>
<b>TABLE C4</b>	<b>Summary of the Incidence of Nonneoplastic Lesions in Male Mice in the 2-Year Inhalation Study of Vinylidene Chloride .....</b>	<b>C-12</b>

**TABLE C1**  
**Summary of the Incidence of Neoplasms in Male Mice in the 2-Year Inhalation Study**  
**of Vinylidene Chloride<sup>a</sup>**

	Chamber Control	6.25 ppm	12.5 ppm	25 ppm
<b>Disposition Summary</b>				
Animals initially in study	50	50	50	50
Early deaths				
Moribund	12	5	14	19
Natural deaths	9	5	4	12
Survivors				
Died last week of study		1		1
Terminal kill	29	39	32	18
Animals examined microscopically	50	50	50	50
<b>Alimentary System</b>				
Esophagus	(50)	(50)	(50)	(50)
Gallbladder	(42)	(45)	(47)	(41)
Intestine large, cecum	(47)	(48)	(48)	(40)
Carcinoma	1 (2%)			
Intestine large, colon	(47)	(48)	(48)	(42)
Intestine large, rectum	(48)	(48)	(48)	(42)
Intestine small, duodenum	(44)	(47)	(47)	(38)
Adenoma			1 (2%)	
Carcinoma				2 (5%)
Intestine small, ileum	(44)	(47)	(47)	(39)
Adenoma	1 (2%)			
Carcinoma		1 (2%)		
Intestine small, jejunum	(43)	(47)	(47)	(39)
Carcinoma		2 (4%)		
Hepatocholangiocarcinoma, metastatic, liver	1 (2%)			
Liver	(50)	(50)	(50)	(50)
Carcinoma, metastatic, testes			1 (2%)	
Hemangioma		1 (2%)	2 (4%)	
Hemangiosarcoma	2 (4%)	2 (4%)	3 (6%)	3 (6%)
Hepatoblastoma	1 (2%)			
Hepatocellular adenoma	17 (34%)	16 (32%)	16 (32%)	12 (24%)
Hepatocellular adenoma, multiple	20 (40%)	19 (38%)	17 (34%)	13 (26%)
Hepatocellular carcinoma	18 (36%)	18 (36%)	11 (22%)	21 (42%)
Hepatocellular carcinoma, multiple	8 (16%)	1 (2%)	4 (8%)	8 (16%)
Hepatocholangiocarcinoma	1 (2%)	2 (4%)	2 (4%)	3 (6%)
Rhabdomyosarcoma, metastatic, skeletal muscle			1 (2%)	
Sarcoma, metastatic, stomach, glandular				1 (2%)
Mesentery	(6)	(9)	(6)	(3)
Hepatocellular carcinoma, metastatic, liver				1 (33%)
Hepatocholangiocarcinoma, metastatic, liver		1 (11%)		1 (33%)
Pancreas	(50)	(49)	(50)	(48)
Hepatocellular carcinoma, metastatic, liver		1 (2%)		
Hepatocholangiocarcinoma, metastatic, liver		1 (2%)		1 (2%)
Rhabdomyosarcoma, metastatic, skeletal muscle			1 (2%)	
Sarcoma, metastatic, stomach, glandular				1 (2%)
Salivary glands	(50)	(50)	(50)	(50)

**TABLE C1**  
**Summary of the Incidence of Neoplasms in Male Mice in the 2-Year Inhalation Study**  
**of Vinylidene Chloride**

	Chamber Control	6.25 ppm	12.5 ppm	25 ppm
<b>Alimentary System</b> (continued)				
Stomach, forestomach	(49)	(50)	(50)	(49)
Squamous cell papilloma	1 (2%)			1 (2%)
Stomach, glandular	(48)	(49)	(49)	(48)
Hepatocholangiocarcinoma, metastatic, liver				1 (2%)
Sarcoma				1 (2%)
Tongue	(0)	(0)	(1)	(0)
Tooth	(2)	(2)	(0)	(1)
<b>Cardiovascular System</b>				
Blood vessel	(0)	(0)	(1)	(3)
Heart	(50)	(50)	(50)	(50)
Carcinoma, metastatic, Harderian gland		1 (2%)		
Hepatocellular carcinoma, metastatic, liver	1 (2%)	1 (2%)		
Hepatocholangiocarcinoma, metastatic, liver	1 (2%)			
<b>Endocrine System</b>				
Adrenal cortex	(50)	(50)	(50)	(50)
Adenoma			1 (2%)	
Carcinoma		1 (2%)		
Sarcoma, metastatic, stomach, glandular				1 (2%)
Capsule, hepatocholangiocarcinoma, metastatic, liver			1 (2%)	
Subcapsular, adenoma	1 (2%)	1 (2%)	3 (6%)	2 (4%)
Adrenal medulla	(50)	(50)	(50)	(50)
Pheochromocytoma benign	1 (2%)	1 (2%)		1 (2%)
Pheochromocytoma malignant	1 (2%)			
Islets, pancreatic	(50)	(49)	(49)	(49)
Adenoma	2 (4%)	1 (2%)	1 (2%)	
Hepatocholangiocarcinoma, metastatic, liver				1 (2%)
Parathyroid gland	(26)	(22)	(26)	(24)
Pituitary gland	(49)	(49)	(50)	(46)
Pars intermedia, adenoma	1 (2%)			
Thyroid gland	(50)	(49)	(50)	(49)
Follicular cell, adenoma			1 (2%)	
Follicular cell, carcinoma			1 (2%)	
<b>General Body System</b>				
None				
<b>Genital System</b>				
Epididymis	(50)	(50)	(50)	(50)
Preputial gland	(50)	(50)	(50)	(50)
Prostate	(50)	(50)	(50)	(50)
Hepatocellular carcinoma, metastatic, liver		1 (2%)		
Hepatocholangiocarcinoma, metastatic, liver				1 (2%)
Seminal vesicle	(50)	(50)	(50)	(50)
Hepatocholangiocarcinoma, metastatic, liver			1 (2%)	

**TABLE C1**  
**Summary of the Incidence of Neoplasms in Male Mice in the 2-Year Inhalation Study**  
**of Vinylidene Chloride**

	Chamber Control	6.25 ppm	12.5 ppm	25 ppm
<b>Genital System (continued)</b>				
Testes	(50)	(50)	(50)	(50)
Hemangioma	1 (2%)			1 (2%)
Interstitial cell, adenoma	1 (2%)	2 (4%)	1 (2%)	1 (2%)
Interstitial cell, carcinoma			1 (2%)	
<b>Hematopoietic System</b>				
Bone marrow	(50)	(50)	(50)	(50)
Hemangioma			1 (2%)	
Hemangiosarcoma	1 (2%)		1 (2%)	2 (4%)
Lymph node	(2)	(2)	(0)	(2)
Pancreatic, sarcoma, metastatic, stomach, glandular				1 (50%)
Renal, hepatocholangiocarcinoma, metastatic, liver		1 (50%)		
Lymph node, bronchial	(33)	(34)	(31)	(19)
Hepatocholangiocarcinoma, metastatic, liver	1 (3%)	1 (3%)		
Lymph node, mandibular	(17)	(29)	(19)	(25)
Lymph node, mediastinal	(43)	(29)	(43)	(38)
Alveolar/bronchiolar carcinoma, metastatic, lung				1 (3%)
Carcinoma, metastatic, Harderian gland		1 (3%)		
Hemangiosarcoma			1 (2%)	
Hepatocholangiocarcinoma, metastatic, liver	1 (2%)		1 (2%)	1 (3%)
Rhabdomyosarcoma, metastatic, skeletal muscle			1 (2%)	
Lymph node, mesenteric	(46)	(48)	(48)	(47)
Carcinoma, metastatic, intestine large, cecum	1 (2%)			
Carcinoma, metastatic, intestine small, duodenum				1 (2%)
Hepatocholangiocarcinoma, metastatic, liver		1 (2%)		1 (2%)
Spleen	(50)	(49)	(50)	(50)
Hemangiosarcoma	2 (4%)	3 (6%)	1 (2%)	4 (8%)
Thymus	(39)	(37)	(38)	(26)
Hemangiosarcoma		1 (3%)		
<b>Integumentary System</b>				
Mammary gland	(1)	(2)	(0)	(1)
Skin	(50)	(50)	(50)	(50)
Fibrous histiocytoma	1 (2%)	2 (4%)	1 (2%)	2 (4%)
Keratoacanthoma	1 (2%)			
Subcutaneous tissue, liposarcoma	1 (2%)			
Subcutaneous tissue, schwannoma malignant				1 (2%)

**TABLE C1**  
**Summary of the Incidence of Neoplasms in Male Mice in the 2-Year Inhalation Study**  
**of Vinylidene Chloride**

	Chamber Control	6.25 ppm	12.5 ppm	25 ppm
<b>Musculoskeletal System</b>				
Bone	(50)	(50)	(50)	(50)
Skeletal muscle	(1)	(1)	(2)	(2)
Hemangiosarcoma	1 (100%)			1 (50%)
Hepatocholangiocarcinoma, metastatic, liver		1 (100%)	1 (50%)	1 (50%)
Rhabdomyosarcoma			1 (50%)	
<b>Nervous System</b>				
Brain	(50)	(50)	(50)	(50)
Carcinoma, metastatic, Harderian gland		1 (2%)		
<b>Respiratory System</b>				
Larynx	(50)	(50)	(50)	(49)
Lung	(50)	(50)	(50)	(50)
Alveolar/bronchiolar adenoma	7 (14%)	7 (14%)	8 (16%)	7 (14%)
Alveolar/bronchiolar adenoma, multiple		1 (2%)		
Alveolar/bronchiolar carcinoma	8 (16%)	8 (16%)	8 (16%)	6 (12%)
Alveolar/bronchiolar carcinoma, multiple	1 (2%)	1 (2%)		
Carcinoma, metastatic, Harderian gland		1 (2%)		
Carcinoma, metastatic, intestine small, duodenum				1 (2%)
Hemangiosarcoma	1 (2%)			
Hepatocellular carcinoma, metastatic, liver	10 (20%)	11 (22%)	8 (16%)	4 (8%)
Hepatocholangiocarcinoma, metastatic, liver	1 (2%)	1 (2%)	1 (2%)	2 (4%)
Rhabdomyosarcoma, metastatic, skeletal muscle			1 (2%)	
Nose	(50)	(50)	(49)	(49)
Pleura	(1)	(1)	(0)	(0)
Carcinoma, metastatic, Harderian gland		1 (100%)		
Hepatocholangiocarcinoma, metastatic, liver	1 (100%)			
Trachea	(50)	(50)	(50)	(50)
<b>Special Senses System</b>				
Eye	(50)	(50)	(50)	(48)
Harderian gland	(50)	(50)	(50)	(50)
Adenoma	7 (14%)	6 (12%)	8 (16%)	8 (16%)
Carcinoma		2 (4%)	1 (2%)	

**TABLE C1**  
**Summary of the Incidence of Neoplasms in Male Mice in the 2-Year Inhalation Study**  
**of Vinylidene Chloride**

	Chamber Control	6.25 ppm	12.5 ppm	25 ppm
<b>Urinary System</b>				
Kidney	(50)	(50)	(50)	(50)
Hemangiosarcoma	1 (2%)			
Hepatocellular carcinoma, metastatic, liver		1 (2%)		1 (2%)
Hepatocholangiocarcinoma, metastatic, liver	1 (2%)	1 (2%)	1 (2%)	1 (2%)
Rhabdomyosarcoma, metastatic, skeletal muscle			1 (2%)	
Bilateral, renal tubule, adenoma			1 (2%)	
Bilateral, renal tubule, carcinoma		1 (2%)	7 (14%)	6 (12%)
Bilateral, renal tubule, carcinoma, multiple			4 (8%)	
Capsule, sarcoma, metastatic, stomach, glandular				1 (2%)
Renal tubule, adenoma		5 (10%)	15 (30%)	10 (20%)
Renal tubule, adenoma, multiple			3 (6%)	
Renal tubule, carcinoma		6 (12%)	17 (34%)	12 (24%)
Renal tubule, carcinoma, multiple			3 (6%)	
Urinary bladder	(50)	(50)	(50)	(49)
<b>Systemic Lesions</b>				
Multiple organs <sup>b</sup>	(50)	(50)	(50)	(50)
Histiocytic sarcoma	2 (4%)	1 (2%)	1 (2%)	1 (2%)
Lymphoma malignant	2 (4%)	2 (4%)	4 (8%)	
<b>Neoplasm Summary</b>				
Total animals with primary neoplasms <sup>c</sup>	49	49	49	48
Total primary neoplasms	114	114	151	130
Total animals with benign neoplasms	43	41	43	35
Total benign neoplasms	61	60	79	57
Total animals with malignant neoplasms	37	38	42	43
Total malignant neoplasms	53	54	72	73
Total animals with metastatic neoplasms	11	13	11	7
Total metastatic neoplasms	19	28	20	25

<sup>a</sup> Number of animals examined microscopically at the site and the number of animals with neoplasm

<sup>b</sup> Number of animals with any tissue examined microscopically

<sup>c</sup> Primary neoplasms: all neoplasms except metastatic neoplasms

**TABLE C2**  
**Statistical Analysis of Primary Neoplasms in Male Mice in the 2-Year Inhalation Study**  
**of Vinylidene Chloride**

	<b>Chamber Control</b>	<b>6.25 ppm</b>	<b>12.5 ppm</b>	<b>25 ppm</b>
<b>Adrenal Cortex: Adenoma</b>				
Overall rate <sup>a</sup>	1/50 (2%)	1/50 (2%)	4/50 (8%)	2/50 (4%)
Adjusted rate <sup>b</sup>	2.4%	2.1%	9.6%	5.5%
Terminal rate <sup>c</sup>	1/29 (3%)	1/40 (3%)	4/32 (13%)	1/19 (5%)
First incidence (days)	729 (T)	729 (T)	729 (T)	705
Poly-3 test <sup>d</sup>	P=0.218	P=0.734N	P=0.173	P=0.451
<b>Harderian Gland: Adenoma</b>				
Overall rate	7/50 (14%)	6/50 (12%)	8/50 (16%)	8/50 (16%)
Adjusted rate	16.5%	12.7%	18.9%	21.2%
Terminal rate	5/29 (17%)	6/40 (15%)	5/32 (16%)	4/19 (21%)
First incidence (days)	694	729 (T)	599	575
Poly-3 test	P=0.252	P=0.416N	P=0.498	P=0.401
<b>Harderian Gland: Adenoma or Carcinoma</b>				
Overall rate	7/50 (14%)	8/50 (16%)	9/50 (18%)	8/50 (16%)
Adjusted rate	16.5%	16.9%	21.3%	21.2%
Terminal rate	5/29 (17%)	7/40 (18%)	6/32 (19%)	4/19 (21%)
First incidence (days)	694	680	599	575
Poly-3 test	P=0.302	P=0.594	P=0.389	P=0.401
<b>Small Intestine (Duodenum, Jejunum, or Ileum): Carcinoma</b>				
Overall rate	0/50 (0%)	3/50 (6%)	0/50 (0%)	2/50 (4%)
Adjusted rate	0.0%	6.4%	0.0%	5.4%
Terminal rate	0/29 (0%)	3/40 (8%)	0/32 (0%)	1/19 (5%)
First incidence (days)	— <sup>e</sup>	729 (T)	—	563
Poly-3 test	P=0.311	P=0.141	— <sup>f</sup>	P=0.209
<b>Small Intestine (Duodenum, Jejunum, or Ileum): Adenoma or Carcinoma</b>				
Overall rate	1/50 (2%)	3/50 (6%)	1/50 (2%)	2/50 (4%)
Adjusted rate	2.4%	6.4%	2.4%	5.4%
Terminal rate	1/29 (3%)	3/40 (8%)	1/32 (3%)	1/19 (5%)
First incidence (days)	729 (T)	729 (T)	729 (T)	563
Poly-3 test	P=0.463	P=0.348	P=0.758	P=0.455
<b>Kidney (Renal Tubule): Adenoma</b>				
Overall rate	0/50 (0%)	5/50 (10%)	19/50 (38%)	10/50 (20%)
Adjusted rate	0.0%	10.6%	44.2%	26.7%
Terminal rate	0/29 (0%)	5/40 (13%)	15/32 (47%)	8/19 (42%)
First incidence (days)	—	729 (T)	600	525
Poly-3 test	P<0.001	P=0.041	P<0.001	P<0.001
<b>Kidney (Renal Tubule): Carcinoma</b>				
Overall rate	0/50 (0%)	7/50 (14%)	31/50 (62%)	18/50 (36%)
Adjusted rate	0.0%	14.7%	70.5%	45.8%
Terminal rate	0/29 (0%)	5/40 (13%)	24/32 (75%)	10/19 (53%)
First incidence (days)	—	619	429	537
Poly-3 test	P<0.001	P=0.012	P<0.001	P<0.001
<b>Kidney (Renal Tubule): Adenoma or Carcinoma</b>				
Overall rate	0/50 (0%)	11/50 (22%)	37/50 (74%)	27/50 (54%)
Adjusted rate	0.0%	23.1%	81.9%	67.0%
Terminal rate	0/29 (0%)	9/40 (23%)	27/32 (84%)	17/19 (90%)
First incidence (days)	—	619	429	525
Poly-3 test	P<0.001	P<0.001	P<0.001	P<0.001



**TABLE C2**  
**Statistical Analysis of Primary Neoplasms in Male Mice in the 2-Year Inhalation Study**  
**of Vinylidene Chloride**

	<b>Chamber Control</b>	<b>6.25 ppm</b>	<b>12.5 ppm</b>	<b>25 ppm</b>
<b>Liver: Hemangiosarcoma</b>				
Overall rate	2/50 (4%)	2/50 (4%)	3/50 (6%)	3/50 (6%)
Adjusted rate	4.7%	4.2%	7.2%	7.9%
Terminal rate	0/29 (0%)	2/40 (5%)	3/32 (9%)	0/19 (0%)
First incidence (days)	596	729 (T)	729 (T)	470
Poly-3 test	P=0.292	P=0.659N	P=0.484	P=0.443
<b>Liver: Hepatocellular Adenoma</b>				
Overall rate	37/50 (74%)	35/50 (70%)	33/50 (66%)	25/50 (50%)
Adjusted rate	77.6%	72.5%	73.8%	60.0%
Terminal rate	21/29 (72%)	31/40 (78%)	25/32 (78%)	12/19 (63%)
First incidence (days)	443	619	429	471
Poly-3 test	P=0.040N	P=0.361N	P=0.422N	P=0.046N
<b>Liver: Hepatocellular Carcinoma</b>				
Overall rate	26/50 (52%)	19/50 (38%)	15/50 (30%)	29/50 (58%)
Adjusted rate	55.0%	38.1%	33.2%	64.4%
Terminal rate	11/29 (38%)	11/40 (28%)	7/32 (22%)	10/19 (53%)
First incidence (days)	443	521	508	425
Poly-3 test	P=0.118	P=0.070N	P=0.026N	P=0.234
<b>Liver: Hepatocellular Adenoma or Carcinoma</b>				
Overall rate	44/50 (88%)	41/50 (82%)	41/50 (82%)	42/50 (84%)
Adjusted rate	89.2%	82.1%	86.8%	89.2%
Terminal rate	24/29 (83%)	32/40 (80%)	28/32 (88%)	17/19 (90%)
First incidence (days)	443	521	429	425
Poly-3 test	P=0.425	P=0.233N	P=0.481N	P=0.634
<b>Liver: Hepatocellular Carcinoma or Hepatoblastoma</b>				
Overall rate	27/50 (54%)	19/50 (38%)	15/50 (30%)	29/50 (58%)
Adjusted rate	57.1%	38.1%	33.2%	64.4%
Terminal rate	12/29 (41%)	11/40 (28%)	7/32 (22%)	10/19 (53%)
First incidence (days)	443	521	508	425
Poly-3 test	P=0.156	P=0.045N	P=0.015N	P=0.302
<b>Liver: Hepatocellular Adenoma, Hepatocellular Carcinoma, or Hepatoblastoma</b>				
Overall rate	45/50 (90%)	41/50 (82%)	41/50 (82%)	42/50 (84%)
Adjusted rate	91.2%	82.1%	86.8%	89.2%
Terminal rate	25/29 (86%)	32/40 (80%)	28/32 (88%)	17/19 (90%)
First incidence (days)	443	521	429	425
Poly-3 test	P=0.529	P=0.146N	P=0.350N	P=0.506N
<b>Liver: Hepatocholangiocarcinoma</b>				
Overall rate	1/50 (2%)	2/50 (4%)	2/50 (4%)	3/50 (6%)
Adjusted rate	2.4%	4.2%	4.7%	8.0%
Terminal rate	0/29 (0%)	1/40 (3%)	0/32 (0%)	1/19 (5%)
First incidence (days)	704	701	429	563
Poly-3 test	P=0.181	P=0.540	P=0.503	P=0.262
<b>Lung: Alveolar/bronchiolar Adenoma</b>				
Overall rate	7/50 (14%)	8/50 (16%)	8/50 (16%)	7/50 (14%)
Adjusted rate	16.6%	16.9%	18.4%	18.8%
Terminal rate	6/29 (21%)	7/40 (18%)	5/32 (16%)	5/19 (26%)
First incidence (days)	694	658	404	548
Poly-3 test	P=0.430	P=0.597	P=0.524	P=0.512

**TABLE C2**  
**Statistical Analysis of Primary Neoplasms in Male Mice in the 2-Year Inhalation Study**  
**of Vinylidene Chloride**

	<b>Chamber Control</b>	<b>6.25 ppm</b>	<b>12.5 ppm</b>	<b>25 ppm</b>
<b>Lung: Alveolar/bronchiolar Carcinoma</b>				
Overall rate	9/50 (18%)	9/50 (18%)	8/50 (16%)	6/50 (12%)
Adjusted rate	21.1%	19.0%	18.6%	16.3%
Terminal rate	8/29 (28%)	8/40 (20%)	5/32 (16%)	5/19 (26%)
First incidence (days)	512	664	508	633
Poly-3 test	P=0.350N	P=0.506N	P=0.497N	P=0.400N
<b>Lung: Alveolar/bronchiolar Adenoma or Carcinoma</b>				
Overall rate	13/50 (26%)	16/50 (32%)	14/50 (28%)	12/50 (24%)
Adjusted rate	30.3%	33.5%	31.4%	32.0%
Terminal rate	11/29 (38%)	14/40 (35%)	9/32 (28%)	9/19 (47%)
First incidence (days)	512	658	404	548
Poly-3 test	P=0.513	P=0.459	P=0.547	P=0.531
<b>Spleen: Hemangiosarcoma</b>				
Overall rate	2/50 (4%)	3/49 (6%)	1/50 (2%)	4/50 (8%)
Adjusted rate	4.7%	6.5%	2.4%	10.8%
Terminal rate	0/29 (0%)	3/40 (8%)	0/32 (0%)	2/19 (11%)
First incidence (days)	596	729 (T)	648	548
Poly-3 test	P=0.236	P=0.537	P=0.509N	P=0.272
<b>All Organs: Hemangioma</b>				
Overall rate	1/50 (2%)	1/50 (2%)	3/50 (6%)	1/50 (2%)
Adjusted rate	2.4%	2.1%	7.2%	2.7%
Terminal rate	1/29 (3%)	1/40 (3%)	2/32 (6%)	1/19 (5%)
First incidence (days)	729 (T)	729 (T)	726	729 (T)
Poly-3 test	P=0.452	P=0.734N	P=0.300	P=0.728
<b>All Organs: Hemangiosarcoma</b>				
Overall rate	2/50 (4%)	5/50 (10%)	5/50 (10%)	6/50 (12%)
Adjusted rate	4.7%	10.6%	12.0%	15.6%
Terminal rate	0/29 (0%)	5/40 (13%)	4/32 (13%)	2/19 (11%)
First incidence (days)	596	729 (T)	648	470
Poly-3 test	P=0.088	P=0.257	P=0.204	P=0.098
<b>All Organs: Hemangioma or Hemangiosarcoma</b>				
Overall rate	3/50 (6%)	6/50 (12%)	8/50 (16%)	6/50 (12%)
Adjusted rate	7.0%	12.7%	19.1%	15.6%
Terminal rate	1/29 (3%)	6/40 (15%)	6/32 (19%)	2/19 (11%)
First incidence (days)	596	729 (T)	648	470
Poly-3 test	P=0.148	P=0.291	P=0.088	P=0.188
<b>All Organs: Malignant Lymphoma</b>				
Overall rate	2/50 (4%)	2/50 (4%)	4/50 (8%)	0/50 (0%)
Adjusted rate	4.7%	4.2%	9.6%	0.0%
Terminal rate	1/29 (3%)	0/40 (0%)	4/32 (13%)	0/19 (0%)
First incidence (days)	661	639	729 (T)	—
Poly-3 test	P=0.321N	P=0.651N	P=0.327	P=0.272N
<b>All Organs: Benign Neoplasms</b>				
Overall rate	43/50 (86%)	41/50 (82%)	43/50 (86%)	35/50 (70%)
Adjusted rate	90.2%	84.4%	89.8%	81.4%
Terminal rate	27/29 (93%)	36/40 (90%)	29/32 (91%)	18/19 (95%)
First incidence (days)	443	619	404	471
Poly-3 test	P=0.176N	P=0.280N	P=0.621N	P=0.144N

**TABLE C2**  
**Statistical Analysis of Primary Neoplasms in Male Mice in the 2-Year Inhalation Study**  
**of Vinylidene Chloride**

	<b>Chamber Control</b>	<b>6.25 ppm</b>	<b>12.5 ppm</b>	<b>25 ppm</b>
<b>All Organs: Malignant Neoplasms</b>				
Overall rate	37/50 (74%)	38/50 (76%)	42/50 (84%)	43/50 (86%)
Adjusted rate	76.6%	76.0%	89.0%	90.0%
Terminal rate	19/29 (66%)	28/40 (70%)	28/32 (88%)	17/19 (90%)
First incidence (days)	443	521	429	425
Poly-3 test	P=0.020	P=0.567N	P=0.082	P=0.058
<b>All Organs: Benign or Malignant Neoplasms</b>				
Overall rate	49/50 (98%)	49/50 (98%)	49/50 (98%)	48/50 (96%)
Adjusted rate	99.3%	98.0%	99.0%	98.2%
Terminal rate	29/29 (100%)	39/40 (98%)	32/32 (100%)	19/19 (100%)
First incidence (days)	443	521	404	425
Poly-3 test	P=0.541N	P=0.624N	P=0.927N	P=0.732N

(T) Terminal kill

<sup>a</sup> Number of neoplasm-bearing animals/number of animals examined. Denominator is number of animals examined microscopically for adrenal gland, kidney, liver, lung, and spleen; for other tissues, denominator is number of animals necropsied.

<sup>b</sup> Poly-3 estimated neoplasm incidence after adjustment for intercurrent mortality

<sup>c</sup> Observed incidence at terminal kill

<sup>d</sup> Beneath the chamber control incidence is the P value associated with the trend test. Beneath the exposed group incidence are the P values corresponding to pairwise comparisons between the chamber controls and that exposed group. The Poly-3 test accounts for differential mortality in animals that do not reach terminal kill. A negative trend or a lower incidence in an exposure group is indicated by N.

<sup>e</sup> Not applicable; no neoplasms in animal group

<sup>f</sup> Value of statistic cannot be computed.

**TABLE C3**  
**Historical Incidence of Renal Tubule Neoplasms in Control Male B6C3F1/N Mice<sup>a</sup>**

Study (Study Start)	Adenoma	Carcinoma	Adenoma or Carcinoma
<b>Historical Incidence: Inhalation Studies</b>			
1-Bromopropane (July 2003)	0/49	0/49	0/49
CIMSTAR 3800 (May 2008)	0/50	0/50	0/50
Cobalt (May 2006)	0/50	0/50	0/50
Diethylamine (August 2003)	0/50	0/50	0/50
Tetralin (June 2003)	0/49	0/49	0/49
Vinylidene chloride (June 2005)	0/50	0/50	0/50
Total (%)	0/298	0/298	0/298
<b>Overall Historical Incidence: All Routes</b>			
Total (%)	8/944 (0.9%)	3/944 (0.3%)	11/944 (1.2%)
Mean ± standard deviation	0.9% ± 1.4%	0.3% ± 1.0%	1.2% ± 1.8%
Range	0%-4%	0%-4%	0%-6%

<sup>a</sup> Data as of June 2013

**TABLE C4**  
**Summary of the Incidence of Nonneoplastic Lesions in Male Mice in the 2-Year Inhalation Study**  
**of Vinylidene Chloride<sup>a</sup>**

	Chamber Control	6.25 ppm	12.5 ppm	25 ppm
<b>Disposition Summary</b>				
Animals initially in study	50	50	50	50
Early deaths				
Moribund	12	5	14	19
Natural deaths	9	5	4	12
Survivors				
Died last week of study		1		1
Terminal kill	29	39	32	18
Animals examined microscopically	50	50	50	50
<b>Alimentary System</b>				
Esophagus	(50)	(50)	(50)	(50)
Gallbladder	(42)	(45)	(47)	(41)
Intestine large, cecum	(47)	(48)	(48)	(40)
Artery, inflammation				1 (3%)
Intestine large, colon	(47)	(48)	(48)	(42)
Intestine large, rectum	(48)	(48)	(48)	(42)
Intestine small, duodenum	(44)	(47)	(47)	(38)
Necrosis	1 (2%)		1 (2%)	
Intestine small, ileum	(44)	(47)	(47)	(39)
Hyperplasia			1 (2%)	
Intestine small, jejunum	(43)	(47)	(47)	(39)
Liver	(50)	(50)	(50)	(50)
Angiectasis	1 (2%)	1 (2%)		
Basophilic focus	2 (4%)	4 (8%)	2 (4%)	7 (14%)
Clear cell focus	16 (32%)	11 (22%)	10 (20%)	8 (16%)
Cyst			2 (4%)	2 (4%)
Degeneration, cystic			1 (2%)	1 (2%)
Eosinophilic focus	9 (18%)	7 (14%)	4 (8%)	6 (12%)
Fatty change	1 (2%)			
Infarct		1 (2%)		
Mineralization				1 (2%)
Mixed cell focus	2 (4%)	2 (4%)	1 (2%)	1 (2%)
Necrosis	5 (10%)	1 (2%)	2 (4%)	6 (12%)
Thrombosis		1 (2%)		
Mesentery	(6)	(9)	(6)	(3)
Fat, necrosis	6 (100%)	8 (89%)	6 (100%)	1 (33%)
Pancreas	(50)	(49)	(50)	(48)
Artery, inflammation, chronic active			1 (2%)	
Salivary glands	(50)	(50)	(50)	(50)
Stomach, forestomach	(49)	(50)	(50)	(49)
Hyperplasia, squamous	4 (8%)	1 (2%)	7 (14%)	10 (20%)
Inflammation, chronic active	2 (4%)	2 (4%)	3 (6%)	7 (14%)
Mineralization		1 (2%)		
Necrosis	1 (2%)	2 (4%)	2 (4%)	4 (8%)
Ulcer	1 (2%)	1 (2%)		2 (4%)
Artery, inflammation, chronic active				1 (2%)
Submucosa, necrosis			1 (2%)	

<sup>a</sup> Number of animals examined microscopically at the site and the number of animals with lesion

**TABLE C4**  
**Summary of the Incidence of Nonneoplastic Lesions in Male Mice in the 2-Year Inhalation Study**  
**of Vinylidene Chloride**

	Chamber Control	6.25 ppm	12.5 ppm	25 ppm
<b>Alimentary System</b> (continued)				
Stomach, glandular	(48)	(49)	(49)	(48)
Inflammation, acute		1 (2%)		
Mineralization	2 (4%)	1 (2%)	1 (2%)	1 (2%)
Necrosis	4 (8%)	3 (6%)	3 (6%)	5 (10%)
Tongue	(0)	(0)	(1)	(0)
Angiectasis			1 (100%)	
Tooth	(2)	(2)	(0)	(1)
Dysplasia	2 (100%)	2 (100%)		1 (100%)
<b>Cardiovascular System</b>				
Blood vessel	(0)	(0)	(1)	(3)
Thrombosis				1 (33%)
Heart	(50)	(50)	(50)	(50)
Cardiomyopathy	11 (22%)	10 (20%)	12 (24%)	13 (26%)
Thrombosis			2 (4%)	1 (2%)
Artery, inflammation, chronic active			1 (2%)	2 (4%)
Endothelium, hyperplasia				1 (2%)
<b>Endocrine System</b>				
Adrenal cortex	(50)	(50)	(50)	(50)
Hyperplasia	5 (10%)	6 (12%)	5 (10%)	3 (6%)
Hypertrophy	18 (36%)	11 (22%)	12 (24%)	10 (20%)
Adrenal medulla	(50)	(50)	(50)	(50)
Hyperplasia		3 (6%)	2 (4%)	3 (6%)
Islets, pancreatic	(50)	(49)	(49)	(49)
Hyperplasia	3 (6%)	4 (8%)	4 (8%)	2 (4%)
Parathyroid gland	(26)	(22)	(26)	(24)
Cyst			2 (8%)	1 (4%)
Pituitary gland	(49)	(49)	(50)	(46)
Pars distalis, hyperplasia	1 (2%)	1 (2%)	1 (2%)	2 (4%)
Thyroid gland	(50)	(49)	(50)	(49)
Follicular cell, hyperplasia			1 (2%)	
<b>General Body System</b>				
None				
<b>Genital System</b>				
Epididymis	(50)	(50)	(50)	(50)
Granuloma sperm		1 (2%)	1 (2%)	
Inflammation, chronic	1 (2%)		1 (2%)	
Spermatocele	1 (2%)			
Preputial gland	(50)	(50)	(50)	(50)
Ectasia	1 (2%)	1 (2%)		
Inflammation, suppurative	1 (2%)			
Inflammation, chronic active	3 (6%)	5 (10%)	3 (6%)	2 (4%)
Prostate	(50)	(50)	(50)	(50)
Inflammation, suppurative	1 (2%)	1 (2%)	1 (2%)	1 (2%)
Inflammation, chronic active			2 (4%)	1 (2%)
Artery, inflammation, chronic active			1 (2%)	1 (2%)

**TABLE C4**  
**Summary of the Incidence of Nonneoplastic Lesions in Male Mice in the 2-Year Inhalation Study**  
**of Vinylidene Chloride**

	Chamber Control	6.25 ppm	12.5 ppm	25 ppm
<b>Genital System</b> (continued)				
Seminal vesicle	(50)	(50)	(50)	(50)
Dilatation				1 (2%)
Inflammation, suppurative		1 (2%)		1 (2%)
Testes	(50)	(50)	(50)	(50)
Atrophy		2 (4%)		
Germinal epithelium, degeneration	2 (4%)	5 (10%)	3 (6%)	1 (2%)
Interstitial cell, hyperplasia		1 (2%)		2 (4%)
<b>Hematopoietic System</b>				
Bone marrow	(50)	(50)	(50)	(50)
Erythroid cell, depletion cellular			1 (2%)	
Lymph node	(2)	(2)	(0)	(2)
Lumbar, hyperplasia, lymphoid				1 (50%)
Lymph node, bronchial	(33)	(34)	(31)	(19)
Lymph node, mandibular	(17)	(29)	(19)	(25)
Hyperplasia	1 (6%)			
Lymph node, mediastinal	(43)	(29)	(43)	(38)
Lymph node, mesenteric	(46)	(48)	(48)	(47)
Angiectasis				2 (4%)
Inflammation, granulomatous				2 (2%)
Necrosis		1 (2%)		
Artery, inflammation, chronic active				1 (2%)
Spleen	(50)	(49)	(50)	(50)
Hematopoietic cell proliferation	1 (2%)	4 (8%)	2 (4%)	5 (10%)
Hyperplasia, lymphoid	1 (2%)			
Lymphoid follicle, hyperplasia				1 (2%)
Thymus	(39)	(37)	(38)	(26)
Cyst	1 (3%)			
Necrosis	1 (3%)			
<b>Integumentary System</b>				
Mammary gland	(1)	(2)	(0)	(1)
Skin	(50)	(50)	(50)	(50)
Inflammation, chronic active	1 (2%)			
Necrosis	4 (8%)	5 (10%)	3 (6%)	3 (6%)
Epidermis, hyperplasia, squamous			1 (2%)	1 (2%)
<b>Musculoskeletal System</b>				
Bone	(50)	(50)	(50)	(50)
Fibrous osteodystrophy				1 (2%)
Hyperostosis	1 (2%)			
Cartilage, degeneration		1 (2%)		
Skeletal muscle	(1)	(1)	(2)	(2)
<b>Nervous System</b>				
Brain	(50)	(50)	(50)	(50)
Hemorrhage				1 (2%)
Artery, inflammation, chronic active				1 (2%)

**TABLE C4**  
**Summary of the Incidence of Nonneoplastic Lesions in Male Mice in the 2-Year Inhalation Study**  
**of Vinylidene Chloride**

	Chamber Control	6.25 ppm	12.5 ppm	25 ppm
<b>Respiratory System</b>				
Larynx	(50)	(50)	(50)	(49)
Foreign body	1 (2%)			2 (4%)
Inflammation				1 (2%)
Inflammation, suppurative	1 (2%)	1 (2%)		2 (4%)
Inflammation, chronic active	1 (2%)		1 (2%)	
Metaplasia, squamous	1 (2%)			1 (2%)
Artery, inflammation, chronic active				1 (2%)
Squamous epithelium, necrosis		1 (2%)		1 (2%)
Lung	(50)	(50)	(50)	(50)
Hemorrhage	1 (2%)		1 (2%)	
Inflammation, chronic active	2 (4%)	1 (2%)	3 (6%)	1 (2%)
Thrombosis		1 (2%)		
Alveolar epithelium, hyperplasia	3 (6%)	7 (14%)	4 (8%)	6 (12%)
Alveolus, infiltration cellular, histiocyte	4 (8%)		3 (6%)	4 (8%)
Serosa, hyperplasia				1 (2%)
Nose	(50)	(50)	(49)	(49)
Foreign body	2 (4%)		2 (4%)	4 (8%)
Hemorrhage			1 (2%)	
Hyperostosis	1 (2%)	27 (54%)	45 (92%)	48 (98%)
Inflammation, suppurative	3 (6%)	2 (4%)	4 (8%)	7 (14%)
Inflammation, chronic active		1 (2%)		
Polyp, inflammatory				1 (2%)
Olfactory epithelium, accumulation, hyaline droplet	2 (4%)	5 (10%)	13 (27%)	11 (22%)
Olfactory epithelium, atrophy	1 (2%)	2 (4%)	1 (2%)	
Olfactory epithelium, metaplasia, respiratory	17 (34%)	39 (78%)	47 (96%)	48 (98%)
Olfactory epithelium, necrosis	4 (8%)	1 (2%)	2 (4%)	4 (8%)
Respiratory epithelium, accumulation, hyaline droplet	17 (34%)	21 (42%)	24 (49%)	16 (33%)
Respiratory epithelium, hyperplasia	37 (74%)	36 (72%)	35 (71%)	39 (80%)
Respiratory epithelium, metaplasia, squamous	2 (4%)		3 (6%)	
Respiratory epithelium, necrosis	2 (4%)		2 (4%)	3 (6%)
Turbinate, atrophy		46 (92%)	46 (94%)	47 (96%)
Turbinate, necrosis			1 (2%)	
Pleura	(1)	(1)	(0)	(0)
Trachea	(50)	(50)	(50)	(50)
Inflammation, suppurative	1 (2%)			1 (2%)
Inflammation, chronic active				1 (2%)
Epithelium, necrosis				1 (2%)
<b>Special Senses System</b>				
Eye	(50)	(50)	(50)	(48)
Cataract				1 (2%)
Degeneration			1 (2%)	
Necrosis				1 (2%)
Cornea, hyperplasia, squamous		1 (2%)		
Cornea, inflammation, chronic active		1 (2%)	1 (2%)	
Harderian gland	(50)	(50)	(50)	(50)
Hyperplasia		2 (4%)	3 (6%)	1 (2%)
Inflammation, suppurative				1 (2%)
Inflammation, chronic active		2 (4%)		



**TABLE C4**  
**Summary of the Incidence of Nonneoplastic Lesions in Male Mice in the 2-Year Inhalation Study**  
**of Vinylidene Chloride**

	Chamber Control	6.25 ppm	12.5 ppm	25 ppm
<b>Urinary System</b>				
Kidney	(50)	(50)	(50)	(50)
Cyst	1 (2%)	1 (2%)	5 (10%)	7 (14%)
Hydronephrosis	2 (4%)		1 (2%)	3 (6%)
Infarct	2 (4%)	2 (4%)	2 (4%)	1 (2%)
Inflammation, chronic active			1 (2%)	
Metaplasia, osseous	2 (4%)	1 (2%)	1 (2%)	
Mineralization	1 (2%)			
Nephropathy	44 (88%)	46 (92%)	37 (74%)	44 (88%)
Papilla, necrosis	1 (2%)			
Pelvis, inflammation, chronic active			1 (2%)	
Renal tubule, hyperplasia		8 (16%)	22 (44%)	16 (32%)
Renal tubule, pigmentation		1 (2%)		
Transitional epithelium, hyperplasia			1 (2%)	
Urinary bladder	(50)	(50)	(50)	(49)
Inflammation, chronic active		1 (2%)	1 (2%)	
Necrosis		1 (2%)		1 (2%)
Transitional epithelium, hyperplasia		2 (2%)	3 (6%)	1 (2%)

**APPENDIX D**  
**SUMMARY OF LESIONS IN FEMALE MICE**  
**IN THE 2-YEAR INHALATION STUDY**  
**OF VINYLIDENE CHLORIDE**

<b>TABLE D1</b>	<b>Summary of the Incidence of Neoplasms in Female Mice in the 2-Year Inhalation Study of Vinylidene Chloride .....</b>	<b>D-2</b>
<b>TABLE D2</b>	<b>Statistical Analysis of Primary Neoplasms in Female Mice in the 2-Year Inhalation Study of Vinylidene Chloride .....</b>	<b>D-6</b>
<b>TABLE D3</b>	<b>Historical Incidence of Liver Neoplasms in Control Female B6C3F1/N Mice.....</b>	<b>D-10</b>
<b>TABLE D4</b>	<b>Summary of the Incidence of Nonneoplastic Lesions in Female Mice in the 2-Year Inhalation Study of Vinylidene Chloride .....</b>	<b>D-11</b>

**TABLE D1**  
**Summary of the Incidence of Neoplasms in Female Mice in the 2-Year Inhalation Study**  
**of Vinylidene Chloride<sup>a</sup>**

	Chamber Control	6.25 ppm	12.5 ppm	25 ppm
<b>Disposition Summary</b>				
Animals initially in study	50	50	50	50
Early deaths				
Moribund	11	20	14	17
Natural deaths	3	5	6	9
Survivors				
Died last week of study				1
Terminal kill	36	25	30	23
Animals examined microscopically	50	50	50	50
<b>Alimentary System</b>				
Esophagus	(50)	(50)	(50)	(50)
Gallbladder	(46)	(43)	(45)	(43)
Intestine large, cecum	(49)	(48)	(45)	(45)
Carcinoma	1 (2%)			
Hepatocholangiocarcinoma, metastatic, liver		1 (2%)		
Sarcoma, metastatic, skeletal muscle			1 (2%)	
Intestine large, colon	(49)	(47)	(46)	(46)
Intestine large, rectum	(49)	(47)	(47)	(46)
Intestine small, duodenum	(49)	(47)	(45)	(46)
Adenoma			1 (2%)	
Hepatocholangiocarcinoma, metastatic, liver		1 (2%)		
Intestine small, ileum	(49)	(48)	(45)	(45)
Adenoma	1 (2%)			1 (2%)
Carcinoma	1 (2%)	1 (2%)	1 (2%)	3 (7%)
Intestine small, jejunum	(48)	(47)	(45)	(45)
Liver	(50)	(50)	(50)	(50)
Fibrosarcoma, metastatic, skeletal muscle				1 (2%)
Hemangioma		1 (2%)		2 (4%)
Hemangiosarcoma	1 (2%)	1 (2%)	1 (2%)	6 (12%)
Hepatocellular adenoma	13 (26%)	12 (24%)	10 (20%)	12 (24%)
Hepatocellular adenoma, multiple	12 (24%)	9 (18%)	26 (52%)	17 (34%)
Hepatocellular carcinoma	7 (14%)	12 (24%)	10 (20%)	14 (28%)
Hepatocellular carcinoma, multiple	1 (2%)	2 (4%)	2 (4%)	3 (6%)
Hepatocholangiocarcinoma		1 (2%)	1 (2%)	2 (4%)
Sarcoma, metastatic, skeletal muscle				1 (2%)
Mesentery	(10)	(16)	(19)	(37)
Hemangiosarcoma			1 (5%)	
Hepatocholangiocarcinoma, metastatic, liver		1 (6%)		
Sarcoma		1 (6%)		
Sarcoma, metastatic, skeletal muscle			1 (5%)	1 (3%)
Sarcoma, metastatic, uterus				1 (3%)
Pancreas	(50)	(49)	(50)	(50)
Hepatocholangiocarcinoma, metastatic, liver		1 (2%)		
Sarcoma, metastatic, mesentery		1 (2%)	1 (2%)	
Sarcoma, metastatic, skeletal muscle				1 (2%)
Duct, carcinoma	1 (2%)			
Salivary glands	(50)	(50)	(50)	(50)
Myxoma	1 (2%)			

**TABLE D1**  
**Summary of the Incidence of Neoplasms in Female Mice in the 2-Year Inhalation Study**  
**of Vinylidene Chloride**

	Chamber Control	6.25 ppm	12.5 ppm	25 ppm
<b>Alimentary System</b> (continued)				
Stomach, forestomach	(50)	(49)	(50)	(50)
Hepatocholangiocarcinoma, metastatic, liver		1 (2%)		
Sarcoma, metastatic, skeletal muscle				1 (2%)
Squamous cell papilloma		3 (6%)	1 (2%)	
Stomach, glandular	(49)	(48)	(49)	(49)
Carcinoma	1 (2%)			
Sarcoma, metastatic, skeletal muscle			1 (2%)	1 (2%)
Tooth	(0)	(1)	(0)	(0)
<b>Cardiovascular System</b>				
Blood vessel	(0)	(1)	(0)	(0)
Heart	(50)	(50)	(50)	(50)
Hepatocholangiocarcinoma, metastatic, liver		1 (2%)		
Sarcoma, metastatic, mesentery			1 (2%)	
<b>Endocrine System</b>				
Adrenal cortex	(50)	(49)	(50)	(49)
Hepatocholangiocarcinoma, metastatic, liver			1 (2%)	
Sarcoma, metastatic, skeletal muscle				1 (2%)
Subcapsular, adenoma	1 (2%)			
Adrenal medulla	(50)	(48)	(50)	(49)
Pheochromocytoma benign	1 (2%)			
Pheochromocytoma malignant	1 (2%)	1 (2%)		
Islets, pancreatic	(50)	(49)	(50)	(50)
Adenoma	1 (2%)	1 (2%)	2 (4%)	
Parathyroid gland	(24)	(22)	(21)	(31)
Pituitary gland	(50)	(50)	(48)	(47)
Pars distalis, adenoma	8 (16%)	5 (10%)	8 (17%)	4 (9%)
Pars distalis, carcinoma			1 (2%)	
Thyroid gland	(50)	(50)	(50)	(50)
<b>General Body System</b>				
None				
<b>Genital System</b>				
Clitoral gland	(45)	(46)	(45)	(45)
Ovary	(50)	(49)	(49)	(49)
Cystadenoma	1 (2%)	3 (6%)	1 (2%)	1 (2%)
Hemangioma			2 (4%)	
Hemangiosarcoma				1 (2%)
Hepatocholangiocarcinoma, metastatic, liver		1 (2%)		
Luteoma	1 (2%)			
Uterus	(50)	(49)	(50)	(50)
Adenoma				1 (2%)
Hemangioma		1 (2%)		
Hemangiosarcoma	1 (2%)			1 (2%)
Polyp stromal	2 (4%)	2 (4%)	1 (2%)	3 (6%)
Sarcoma				1 (2%)

**TABLE D1**  
**Summary of the Incidence of Neoplasms in Female Mice in the 2-Year Inhalation Study**  
**of Vinylidene Chloride**

	Chamber Control	6.25 ppm	12.5 ppm	25 ppm
<b>Hematopoietic System</b>				
Bone marrow	(50)	(49)	(50)	(50)
Lymph node	(8)	(11)	(1)	(8)
Lumbar, sarcoma, metastatic, skeletal muscle				1 (13%)
Lumbar, sarcoma, metastatic, skin				1 (13%)
Lymph node, bronchial	(25)	(38)	(38)	(38)
Hepatocholangiocarcinoma, metastatic, liver		1 (3%)	1 (3%)	2 (5%)
Myxosarcoma, metastatic, skin		1 (3%)		
Lymph node, mandibular	(31)	(35)	(30)	(37)
Carcinoma, metastatic, Harderian gland				1 (3%)
Lymph node, mediastinal	(42)	(45)	(45)	(47)
Carcinoma, metastatic, Harderian gland		1 (2%)		
Hemangiosarcoma				1 (2%)
Hepatocholangiocarcinoma, metastatic, liver		1 (2%)	1 (2%)	1 (2%)
Myxosarcoma, metastatic, skin		1 (2%)		
Sarcoma, metastatic, mesentery			1 (2%)	
Lymph node, mesenteric	(47)	(48)	(47)	(45)
Hepatocholangiocarcinoma, metastatic, liver		1 (2%)		
Spleen	(50)	(49)	(50)	(49)
Hemangiosarcoma	3 (6%)	3 (6%)	1 (2%)	1 (2%)
Thymus	(47)	(44)	(46)	(40)
Hepatocholangiocarcinoma, metastatic, liver		1 (2%)		
<b>Integumentary System</b>				
Mammary gland	(50)	(50)	(50)	(50)
Carcinoma	1 (2%)	1 (2%)	2 (4%)	1 (2%)
Skin	(50)	(50)	(50)	(50)
Fibrous histiocytoma		2 (4%)	2 (4%)	3 (6%)
Subcutaneous tissue, fibrosarcoma	1 (2%)	1 (2%)		
Subcutaneous tissue, hemangiosarcoma			1 (2%)	1 (2%)
Subcutaneous tissue, myxosarcoma		1 (2%)	1 (2%)	
Subcutaneous tissue, sarcoma	1 (2%)	1 (2%)	1 (2%)	3 (6%)
Subcutaneous tissue, schwannoma malignant				1 (2%)
<b>Musculoskeletal System</b>				
Bone	(50)	(50)	(50)	(50)
Osteosarcoma				1 (2%)
Skeletal muscle	(3)	(3)	(2)	(4)
Fibrosarcoma				1 (25%)
Hemangiosarcoma		1 (33%)		
Hepatocholangiocarcinoma, metastatic, liver		1 (33%)	1 (50%)	1 (25%)
Sarcoma	1 (33%)		1 (50%)	1 (25%)
<b>Nervous System</b>				
Brain	(50)	(50)	(50)	(50)
Carcinoma, metastatic, pituitary gland			1 (2%)	
Peripheral nerve	(2)	(2)	(0)	(0)
Spinal cord	(2)	(2)	(0)	(1)

**TABLE D1**  
**Summary of the Incidence of Neoplasms in Female Mice in the 2-Year Inhalation Study of Vinylidene Chloride**

	Chamber Control	6.25 ppm	12.5 ppm	25 ppm
<b>Respiratory System</b>				
Larynx	(50)	(50)	(49)	(49)
Lung	(50)	(50)	(50)	(49)
Alveolar/bronchiolar adenoma	2 (4%)	4 (8%)	2 (4%)	2 (4%)
Alveolar/bronchiolar adenoma, multiple	1 (2%)			
Alveolar/bronchiolar carcinoma	1 (2%)	2 (4%)	6 (12%)	5 (10%)
Alveolar/bronchiolar carcinoma, multiple			1 (2%)	
Carcinoma, metastatic, Harderian gland		1 (2%)		1 (2%)
Hepatocellular carcinoma, metastatic, liver	5 (10%)	9 (18%)	3 (6%)	4 (8%)
Hepatocholangiocarcinoma, metastatic, liver		1 (2%)	1 (2%)	2 (4%)
Myxosarcoma, metastatic, skin		1 (2%)		
Sarcoma, metastatic, mesentery			1 (2%)	
Sarcoma, metastatic, skin				1 (2%)
Nose	(50)	(50)	(50)	(50)
Carcinoma, metastatic, Harderian gland		1 (2%)	1 (2%)	1 (2%)
Trachea	(50)	(50)	(50)	(49)
<b>Special Senses System</b>				
Eye	(50)	(49)	(50)	(49)
Harderian gland	(50)	(50)	(50)	(48)
Adenoma	1 (2%)	5 (10%)	4 (8%)	1 (2%)
Carcinoma	3 (6%)	2 (4%)	2 (4%)	2 (4%)
<b>Urinary System</b>				
Kidney	(50)	(50)	(50)	(50)
Sarcoma, metastatic, skeletal muscle				1 (2%)
Renal tubule, adenoma				1 (2%)
Urinary bladder	(49)	(49)	(48)	(48)
Hemangiosarcoma				1 (2%)
Sarcoma, metastatic, uterus				1 (2%)
<b>Systemic Lesions</b>				
Multiple organs <sup>b</sup>	(50)	(50)	(50)	(50)
Histiocytic sarcoma	2 (4%)	2 (4%)	2 (4%)	
Lymphoma malignant	14 (28%)	20 (40%)	13 (26%)	11 (22%)
<b>Neoplasm Summary</b>				
Total animals with primary neoplasms <sup>c</sup>	45	46	47	47
Total primary neoplasms	88	101	109	110
Total animals with benign neoplasms	32	34	38	34
Total benign neoplasms	46	46	58	45
Total animals with malignant neoplasms	33	39	36	41
Total malignant neoplasms	42	55	51	65
Total animals with metastatic neoplasms	5	14	8	11
Total metastatic neoplasms	5	29	17	26

<sup>a</sup> Number of animals examined microscopically at the site and the number of animals with neoplasm

<sup>b</sup> Number of animals with any tissue examined microscopically

<sup>c</sup> Primary neoplasms: all neoplasms except metastatic neoplasms

**TABLE D2**  
**Statistical Analysis of Primary Neoplasms in Female Mice in the 2-Year Inhalation Study**  
**of Vinylidene Chloride**

	<b>Chamber Control</b>	<b>6.25 ppm</b>	<b>12.5 ppm</b>	<b>25 ppm</b>
<b>Harderian Gland: Adenoma</b>				
Overall rate <sup>a</sup>	1/50 (2%)	5/50 (10%)	4/50 (8%)	1/50 (2%)
Adjusted rate <sup>b</sup>	2.3%	12.6%	9.4%	2.6%
Terminal rate <sup>c</sup>	1/36 (3%)	4/25 (16%)	4/30 (13%)	1/24 (4%)
First incidence (days)	731 (T)	705	731 (T)	731 (T)
Poly-3 test <sup>d</sup>	P=0.480N	P=0.081	P=0.174	P=0.732
<b>Harderian Gland: Carcinoma</b>				
Overall rate	3/50 (6%)	2/50 (4%)	2/50 (4%)	2/50 (4%)
Adjusted rate	6.9%	5.0%	4.6%	5.1%
Terminal rate	3/36 (8%)	0/25 (0%)	1/30 (3%)	0/24 (0%)
First incidence (days)	731 (T)	590	599	443
Poly-3 test	P=0.453N	P=0.532N	P=0.501N	P=0.542N
<b>Harderian Gland: Adenoma or Carcinoma</b>				
Overall rate	4/50 (8%)	7/50 (14%)	6/50 (12%)	3/50 (6%)
Adjusted rate	9.2%	17.3%	13.9%	7.6%
Terminal rate	4/36 (11%)	4/25 (16%)	5/30 (17%)	1/24 (4%)
First incidence (days)	731 (T)	590	599	443
Poly-3 test	P=0.374N	P=0.221	P=0.367	P=0.550N
<b>Small Intestine (Duodenum, Jejunum, or Ileum): Carcinoma</b>				
Overall rate	1/50 (2%)	1/50 (2%)	1/50 (2%)	3/50 (6%)
Adjusted rate	2.3%	2.5%	2.3%	7.8%
Terminal rate	0/36 (0%)	0/25 (0%)	0/30 (0%)	2/24 (8%)
First incidence (days)	599	584	536	640
Poly-3 test	P=0.144	P=0.740	P=0.759	P=0.260
<b>Small Intestine (Duodenum or Ileum): Adenoma or Carcinoma</b>				
Overall rate	2/50 (4%)	1/50 (2%)	2/50 (4%)	4/50 (8%)
Adjusted rate	4.6%	2.5%	4.6%	10.4%
Terminal rate	1/36 (3%)	0/25 (0%)	1/30 (3%)	3/24 (13%)
First incidence (days)	599	584	536	640
Poly-3 test	P=0.141	P=0.531N	P=0.691	P=0.279
<b>Liver: Hemangiosarcoma</b>				
Overall rate	1/50 (2%)	1/50 (2%)	1/50 (2%)	6/50 (12%)
Adjusted rate	2.3%	2.5%	2.3%	15.2%
Terminal rate	1/36 (3%)	1/25 (4%)	1/30 (3%)	3/24 (13%)
First incidence (days)	731 (T)	731 (T)	731 (T)	508
Poly-3 test	P=0.007	P=0.740	P=0.758	P=0.041
<b>Liver: Hepatocellular Adenoma</b>				
Overall rate	25/50 (50%)	21/50 (42%)	36/50 (72%)	29/50 (58%)
Adjusted rate	55.3%	49.0%	77.6%	69.0%
Terminal rate	20/36 (56%)	13/25 (52%)	25/30 (83%)	19/24 (79%)
First incidence (days)	509	471	524	443
Poly-3 test	P=0.026	P=0.347N	P=0.015	P=0.126
<b>Liver: Hepatocellular Carcinoma</b>				
Overall rate	8/50 (16%)	14/50 (28%)	12/50 (24%)	17/50 (34%)
Adjusted rate	18.2%	32.4%	27.2%	41.3%
Terminal rate	6/36 (17%)	4/25 (16%)	8/30 (27%)	9/24 (38%)
First incidence (days)	611	478	611	415
Poly-3 test	P=0.022	P=0.097	P=0.223	P=0.015

**TABLE D2**  
**Statistical Analysis of Primary Neoplasms in Female Mice in the 2-Year Inhalation Study**  
**of Vinylidene Chloride**

	<b>Chamber Control</b>	<b>6.25 ppm</b>	<b>12.5 ppm</b>	<b>25 ppm</b>
<b>Liver: Hepatocellular Adenoma or Carcinoma</b>				
Overall rate	28/50 (56%)	30/50 (60%)	37/50 (74%)	38/50 (76%)
Adjusted rate	61.5%	65.4%	79.3%	84.4%
Terminal rate	22/36 (61%)	14/25 (56%)	25/30 (83%)	21/24 (88%)
First incidence (days)	509	471	524	415
Poly-3 test	P=0.003	P=0.434	P=0.041	P=0.009
<b>Lung: Alveolar/bronchiolar Adenoma</b>				
Overall rate	3/50 (6%)	4/50 (8%)	2/50 (4%)	2/49 (4%)
Adjusted rate	6.9%	9.8%	4.7%	5.3%
Terminal rate	3/36 (8%)	1/25 (4%)	2/30 (7%)	1/24 (4%)
First incidence (days)	731 (T)	478	731 (T)	508
Poly-3 test	P=0.369N	P=0.468	P=0.506N	P=0.561N
<b>Lung: Alveolar/bronchiolar Carcinoma</b>				
Overall rate	1/50 (2%)	2/50 (4%)	7/50 (14%)	5/49 (10%)
Adjusted rate	2.3%	4.9%	16.1%	12.7%
Terminal rate	1/36 (3%)	0/25 (0%)	6/30 (20%)	1/24 (4%)
First incidence (days)	731 (T)	558	392	502
Poly-3 test	P=0.038	P=0.477	P=0.030	P=0.080
<b>Lung: Alveolar/bronchiolar Adenoma or Carcinoma</b>				
Overall rate	4/50 (8%)	5/50 (10%)	9/50 (18%)	7/49 (14%)
Adjusted rate	9.2%	12.1%	20.6%	17.5%
Terminal rate	4/36 (11%)	1/25 (4%)	8/30 (27%)	2/24 (8%)
First incidence (days)	731 (T)	478	392	502
Poly-3 test	P=0.141	P=0.472	P=0.115	P=0.216
<b>Ovary: Cystadenoma</b>				
Overall rate	1/50 (2%)	3/49 (6%)	1/49 (2%)	1/49 (2%)
Adjusted rate	2.3%	7.6%	2.4%	2.6%
Terminal rate	1/36 (3%)	2/25 (8%)	0/30 (0%)	0/24 (0%)
First incidence (days)	731 (T)	673	668	502
Poly-3 test	P=0.488N	P=0.270	P=0.756	P=0.730
<b>Pituitary Gland (Pars Distalis): Adenoma</b>				
Overall rate	8/50 (16%)	5/50 (10%)	8/48 (17%)	4/47 (9%)
Adjusted rate	18.5%	12.4%	19.6%	10.7%
Terminal rate	8/36 (22%)	3/25 (12%)	8/28 (29%)	2/24 (8%)
First incidence (days)	731 (T)	584	731 (T)	556
Poly-3 test	P=0.277N	P=0.319N	P=0.557	P=0.252N
<b>Pituitary Gland (Pars Distalis): Adenoma or Carcinoma</b>				
Overall rate	8/50 (16%)	5/50 (10%)	9/48 (19%)	4/47 (9%)
Adjusted rate	18.5%	12.4%	22.0%	10.7%
Terminal rate	8/36 (22%)	3/25 (12%)	8/28 (29%)	2/24 (8%)
First incidence (days)	731 (T)	584	670	556
Poly-3 test	P=0.298N	P=0.319N	P=0.450	P=0.252N
<b>Skin: Fibrous Histiocytoma</b>				
Overall rate	0/50 (0%)	2/50 (4%)	2/50 (4%)	3/50 (6%)
Adjusted rate	0.0%	5.0%	4.7%	7.9%
Terminal rate	0/36 (0%)	0/25 (0%)	1/30 (3%)	3/24 (13%)
First incidence (days)	— <sup>e</sup>	563	668	731 (T)
Poly-3 test	P=0.083	P=0.221	P=0.235	P=0.097



**TABLE D2**  
**Statistical Analysis of Primary Neoplasms in Female Mice in the 2-Year Inhalation Study**  
**of Vinylidene Chloride**

	Chamber Control	6.25 ppm	12.5 ppm	25 ppm
<b>Skin (Subcutaneous Tissue): Sarcoma</b>				
Overall rate	1/50 (2%)	1/50 (2%)	1/50 (2%)	3/50 (6%)
Adjusted rate	2.3%	2.5%	2.3%	7.7%
Terminal rate	1/36 (3%)	0/25 (0%)	1/30 (3%)	0/24 (0%)
First incidence (days)	731 (T)	606	731 (T)	592
Poly-3 test	P=0.148	P=0.743	P=0.758	P=0.269
<b>Skin: Fibrous Histiocytoma, Fibrosarcoma, Myxosarcoma, or Sarcoma</b>				
Overall rate	2/50 (4%)	4/50 (8%)	4/50 (8%)	6/50 (12%)
Adjusted rate	4.6%	9.8%	9.2%	15.4%
Terminal rate	1/36 (3%)	1/25 (4%)	2/30 (7%)	3/24 (13%)
First incidence (days)	605	563	653	592
Poly-3 test	P=0.080	P=0.303	P=0.332	P=0.098
<b>Spleen: Hemangiosarcoma</b>				
Overall rate	3/50 (6%)	3/49 (6%)	1/50 (2%)	1/49 (2%)
Adjusted rate	6.9%	7.5%	2.3%	2.7%
Terminal rate	3/36 (8%)	2/25 (8%)	1/30 (3%)	1/24 (4%)
First incidence (days)	731 (T)	471	731 (T)	731 (T)
Poly-3 test	P=0.188N	P=0.624	P=0.309N	P=0.356N
<b>Stomach (Forestomach): Squamous Cell Papilloma</b>				
Overall rate	0/50 (0%)	3/50 (6%)	1/50 (2%)	0/50 (0%)
Adjusted rate	0.0%	7.6%	2.3%	0.0%
Terminal rate	0/36 (0%)	3/25 (12%)	0/30 (0%)	0/24 (0%)
First incidence (days)	—	731 (T)	653	—
Poly-3 test	P=0.420N	P=0.102	P=0.499	— <sup>f</sup>
<b>Uterus: Stromal Polyp</b>				
Overall rate	2/50 (4%)	2/50 (4%)	1/50 (2%)	3/50 (6%)
Adjusted rate	4.6%	5.0%	2.3%	7.7%
Terminal rate	2/36 (6%)	1/25 (4%)	1/30 (3%)	0/24 (0%)
First incidence (days)	731 (T)	603	731 (T)	626
Poly-3 test	P=0.376	P=0.665	P=0.504N	P=0.453
<b>All Organs: Hemangiosarcoma</b>				
Overall rate	4/50 (8%)	4/50 (8%)	4/50 (8%)	9/50 (18%)
Adjusted rate	9.2%	9.9%	9.2%	22.5%
Terminal rate	4/36 (11%)	3/25 (12%)	2/30 (7%)	5/24 (21%)
First incidence (days)	731 (T)	471	620	508
Poly-3 test	P=0.044	P=0.603	P=0.643	P=0.084
<b>All Organs: Hemangioma or Hemangiosarcoma</b>				
Overall rate	4/50 (8%)	6/50 (12%)	6/50 (12%)	11/50 (22%)
Adjusted rate	9.2%	14.9%	13.9%	27.5%
Terminal rate	4/36 (11%)	4/25 (16%)	4/30 (13%)	7/24 (29%)
First incidence (days)	731 (T)	471	620	508
Poly-3 test	P=0.018	P=0.324	P=0.368	P=0.027
<b>All Organs: Malignant Lymphoma</b>				
Overall rate	14/50 (28%)	20/50 (40%)	13/50 (26%)	11/50 (22%)
Adjusted rate	31.5%	47.0%	30.1%	28.1%
Terminal rate	11/36 (31%)	11/25 (44%)	11/30 (37%)	8/24 (33%)
First incidence (days)	509	563	668	440
Poly-3 test	P=0.231N	P=0.098	P=0.538N	P=0.460N

**TABLE D2**  
**Statistical Analysis of Primary Neoplasms in Female Mice in the 2-Year Inhalation Study**  
**of Vinylidene Chloride**

	<b>Chamber Control</b>	<b>6.25 ppm</b>	<b>12.5 ppm</b>	<b>25 ppm</b>
<b>All Organs: Benign Neoplasms</b>				
Overall rate	32/50 (64%)	34/50 (68%)	38/50 (76%)	34/50 (68%)
Adjusted rate	70.8%	74.1%	81.9%	77.8%
Terminal rate	27/36 (75%)	19/25 (76%)	27/30 (90%)	21/24 (88%)
First incidence (days)	509	471	524	443
Poly-3 test	P=0.210	P=0.452	P=0.142	P=0.292
<b>All Organs: Malignant Neoplasms</b>				
Overall rate	33/50 (66%)	39/50 (78%)	36/50 (72%)	41/50 (82%)
Adjusted rate	69.2%	80.9%	74.9%	83.7%
Terminal rate	23/36 (64%)	17/25 (68%)	21/30 (70%)	18/24 (75%)
First incidence (days)	440	471	392	413
Poly-3 test	P=0.091	P=0.132	P=0.342	P=0.069
<b>All Organs: Benign or Malignant Neoplasms</b>				
Overall rate	45/50 (90%)	46/50 (92%)	47/50 (94%)	47/50 (94%)
Adjusted rate	94.3%	94.0%	94.9%	95.7%
Terminal rate	35/36 (97%)	23/25 (92%)	29/30 (97%)	23/24 (96%)
First incidence (days)	440	471	392	413
Poly-3 test	P=0.434	P=0.660N	P=0.637	P=0.566

(T) Terminal kill

- <sup>a</sup> Number of neoplasm-bearing animals/number of animals examined. Denominator is number of animals examined microscopically for liver, lung, ovary, pituitary gland, and spleen; for other tissues, denominator is number of animals necropsied.
- <sup>b</sup> Poly-3 estimated neoplasm incidence after adjustment for intercurrent mortality
- <sup>c</sup> Observed incidence at terminal kill
- <sup>d</sup> Beneath the chamber control incidence is the P value associated with the trend test. Beneath the exposed group incidence are the P values corresponding to pairwise comparisons between the chamber controls and that exposed group. The Poly-3 test accounts for differential mortality in animals that do not reach terminal kill. A negative trend or a lower incidence in an exposure group is indicated by N.
- <sup>e</sup> Not applicable; no neoplasms in animal group
- <sup>f</sup> Value of statistic cannot be computed.

**TABLE D3**  
**Historical Incidence of Liver Neoplasms in Control Female B6C3F1/N Mice<sup>a</sup>**

Study (Study Start)	Hepatocellular Adenoma	Hepatocellular Carcinoma	Hepatocellular Adenoma or Carcinoma	Hepatocholangiocarcinoma
<b>Historical Incidence: Inhalation Studies</b>				
1-Bromopropane (July 2003)	19/50	5/50	24/50	0/50
CIMSTAR 3800 (May 2008)	19/50	10/50	25/50	0/50
Cobalt (May 2006)	14/50	4/50	16/50	0/50
Diethylamine (August 2003)	14/50	10/50	20/50	0/50
Tetralin (June 2003)	14/50	7/50	20/50	0/50
Vinylidene chloride (June 2005)	25/50	8/50	28/50	0/50
Total (%)	105/300 (35.0%)	44/300 (14.7%)	133/300 (44.3%)	0/300
Mean ± standard deviation	35.0% ± 8.8%	14.7% ± 5.0%	44.3% ± 8.6%	
Range	28%-50%	8%-20%	32%-56%	
<b>Overall Historical Incidence: All Routes</b>				
Total (%)	378/948 (39.9%)	152/948 (16.0%)	448/948 (47.3%)	0/948
Mean ± standard deviation	39.9% ± 18.7%	16.0% ± 10.6%	47.3% ± 19.3%	
Range	14%-78%	4%-46%	20%-82%	

<sup>a</sup> Data as of June 2013

**TABLE D4**  
**Summary of the Incidence of Nonneoplastic Lesions in Female Mice in the 2-Year Inhalation Study**  
**of Vinylidene Chloride<sup>a</sup>**

	Chamber Control	6.25 ppm	12.5 ppm	25 ppm
<b>Disposition Summary</b>				
Animals initially in study	50	50	50	50
Early deaths				
Moribund	11	20	14	17
Natural deaths	3	5	6	9
Survivors				
Died last week of study				1
Terminal kill	36	25	30	23
Animals examined microscopically	50	50	50	50
<b>Alimentary System</b>				
Esophagus	(50)	(50)	(50)	(50)
Gallbladder	(46)	(43)	(45)	(43)
Degeneration, hyaline	1 (2%)			
Hyperplasia	1 (2%)			
Intestine large, cecum	(49)	(48)	(45)	(45)
Infiltration cellular, mast cell			1 (2%)	
Inflammation, chronic active			1 (2%)	
Necrosis			2 (4%)	
Intestine large, colon	(49)	(47)	(46)	(46)
Intestine large, rectum	(49)	(47)	(47)	(46)
Intestine small, duodenum	(49)	(47)	(45)	(46)
Inflammation, suppurative	1 (2%)			
Inflammation, chronic active			1 (2%)	
Intestine small, ileum	(49)	(48)	(45)	(45)
Hemorrhage			1 (2%)	
Hyperplasia		1 (2%)	2 (4%)	
Inflammation, chronic active			1 (2%)	
Ulcer	1 (2%)			
Intestine small, jejunum	(48)	(47)	(45)	(45)
Liver	(50)	(50)	(50)	(50)
Angiectasis	1 (2%)	1 (2%)		2 (4%)
Basophilic focus	1 (2%)	4 (8%)		3 (6%)
Clear cell focus	5 (10%)	2 (4%)	6 (12%)	3 (6%)
Cyst			1 (2%)	
Eosinophilic focus	9 (18%)	10 (20%)	9 (18%)	4 (8%)
Fatty change	2 (4%)		2 (4%)	
Hemorrhage	1 (2%)			
Infarct	1 (2%)		1 (2%)	
Inflammation, suppurative	1 (2%)	1 (2%)		
Inflammation, chronic active			2 (4%)	
Mixed cell focus				1 (2%)
Necrosis	2 (4%)	3 (6%)	6 (12%)	3 (6%)
Vacuolization cytoplasmic				1 (2%)
Mesentery	(10)	(16)	(19)	(37)
Angiectasis			1 (5%)	
Infiltration cellular, mononuclear cell				1 (3%)
Artery, inflammation	1 (10%)			
Fat, necrosis	8 (80%)	14 (88%)	15 (79%)	33 (89%)

<sup>a</sup> Number of animals examined microscopically at the site and the number of animals with lesion

**TABLE D4**  
**Summary of the Incidence of Nonneoplastic Lesions in Female Mice in the 2-Year Inhalation Study**  
**of Vinylidene Chloride**

	Chamber Control	6.25 ppm	12.5 ppm	25 ppm
<b>Alimentary System (continued)</b>				
Pancreas	(50)	(49)	(50)	(50)
Atrophy				1 (2%)
Cyst		1 (2%)	1 (2%)	
Fibrosis		1 (2%)		
Inflammation, chronic active	1 (2%)	1 (2%)		
Necrosis	1 (2%)			1 (2%)
Artery, inflammation, chronic active	2 (4%)			
Salivary glands	(50)	(50)	(50)	(50)
Inflammation, suppurative			1 (2%)	
Necrosis		1 (2%)		
Stomach, forestomach	(50)	(49)	(50)	(50)
Hyperplasia, squamous	2 (4%)	2 (4%)		2 (4%)
Inflammation, chronic active				1 (2%)
Necrosis		1 (2%)	1 (2%)	4 (8%)
Ulcer	1 (2%)			1 (2%)
Artery, inflammation, chronic active		1 (2%)		
Stomach, glandular	(49)	(48)	(49)	(49)
Mineralization	2 (4%)	2 (4%)	2 (4%)	
Necrosis		1 (2%)	3 (6%)	1 (2%)
Artery, inflammation, chronic active	1 (2%)	1 (2%)		
Tooth	(0)	(1)	(0)	(0)
Dysplasia		1 (100%)		
<b>Cardiovascular System</b>				
Blood vessel	(0)	(1)	(0)	(0)
Heart	(50)	(50)	(50)	(50)
Cardiomyopathy	9 (18%)	12 (24%)	12 (24%)	9 (18%)
Inflammation, suppurative			1 (2%)	
Mineralization	2 (4%)	1 (2%)		
Necrosis, chronic		1 (2%)		
Thrombosis		2 (4%)	1 (2%)	3 (6%)
Artery, inflammation, chronic active	2 (4%)	2 (4%)		
<b>Endocrine System</b>				
Adrenal cortex	(50)	(49)	(50)	(49)
Angiectasis	1 (2%)	1 (2%)		
Hyperplasia	6 (12%)	6 (12%)	8 (16%)	8 (16%)
Hypertrophy	4 (8%)		5 (10%)	3 (6%)
Inflammation, suppurative		1 (2%)		
Vacuolization cytoplasmic			1 (2%)	
Subcapsular, hyperplasia		1 (2%)		
Adrenal medulla	(50)	(48)	(50)	(49)
Hyperplasia	1 (2%)	3 (6%)	1 (2%)	4 (8%)
Inflammation, suppurative		1 (2%)		
Islets, pancreatic	(50)	(49)	(50)	(50)
Hyperplasia	1 (2%)	1 (2%)	1 (2%)	3 (6%)
Parathyroid gland	(24)	(22)	(21)	(31)
Pituitary gland	(50)	(50)	(48)	(47)
Pars distalis, angiectasis			2 (4%)	1 (2%)
Pars distalis, cyst				1 (2%)
Pars distalis, hyperplasia	6 (12%)	9 (18%)	8 (17%)	8 (17%)
Thyroid gland	(50)	(50)	(50)	(50)
Follicular cell, hyperplasia		2 (4%)	2 (4%)	

**TABLE D4**  
**Summary of the Incidence of Nonneoplastic Lesions in Female Mice in the 2-Year Inhalation Study**  
**of Vinylidene Chloride**

	Chamber Control	6.25 ppm	12.5 ppm	25 ppm
<b>General Body System</b>				
None				
<b>Genital System</b>				
Clitoral gland	(45)	(46)	(45)	(45)
Hyperplasia			1 (2%)	
Inflammation, chronic active				1 (2%)
Ovary	(50)	(49)	(49)	(49)
Angiectasis			2 (4%)	
Cyst	6 (12%)	6 (12%)	12 (24%)	2 (4%)
Thrombosis		2 (4%)	2 (4%)	1 (2%)
Uterus	(50)	(49)	(50)	(50)
Adenomyosis			1 (2%)	
Angiectasis			1 (2%)	
Hemorrhage			1 (2%)	
Inflammation, suppurative		1 (2%)	1 (2%)	
Inflammation, histiocytic, chronic active	1 (2%)			
Inflammation, chronic active	1 (2%)			
Necrosis			1 (2%)	
Thrombosis	1 (2%)		2 (4%)	1 (2%)
Ulcer		1 (2%)		
Endometrium, hyperplasia, cystic	36 (72%)	41 (84%)	46 (92%)	46 (92%)
<b>Hematopoietic System</b>				
Bone marrow	(50)	(49)	(50)	(50)
Thrombosis				1 (2%)
Myeloid cell hyperplasia		1 (2%)	2 (4%)	1 (2%)
Lymph node	(8)	(11)	(1)	(8)
Hyperplasia, lymphoid				1 (13%)
Iliac, ectasia		1 (9%)		
Lumbar, renal, angiectasis	1 (13%)			
Lumbar, renal, inflammation, granulomatous	1 (13%)			
Renal, angiectasis	1 (13%)			
Renal, ectasia				1 (13%)
Lymph node, bronchial	(25)	(38)	(38)	(38)
Lymph node, mandibular	(31)	(35)	(30)	(37)
Angiectasis		1 (3%)		1 (3%)
Lymph node, mediastinal	(42)	(45)	(45)	(47)
Lymph node, mesenteric	(47)	(48)	(47)	(45)
Hemorrhage				1 (2%)
Hyperplasia, lymphoid		1 (2%)	1 (2%)	
Spleen	(50)	(49)	(50)	(49)
Hematopoietic cell proliferation	3 (6%)	6 (12%)	7 (14%)	9 (18%)
Necrosis		1 (2%)		
Thymus	(47)	(44)	(46)	(40)
Cyst				1 (3%)
<b>Integumentary System</b>				
Mammary gland	(50)	(50)	(50)	(50)
Hyperplasia		1 (2%)		3 (6%)
Skin	(50)	(50)	(50)	(50)
Hemorrhage		1 (2%)		
Inflammation, chronic active				1 (2%)
Necrosis	3 (6%)	2 (4%)	2 (4%)	

**TABLE D4**  
**Summary of the Incidence of Nonneoplastic Lesions in Female Mice in the 2-Year Inhalation Study**  
**of Vinylidene Chloride**

	Chamber Control	6.25 ppm	12.5 ppm	25 ppm
<b>Musculoskeletal System</b>				
Bone	(50)	(50)	(50)	(50)
Cyst				1 (2%)
Degeneration				1 (2%)
Hyperostosis		1 (2%)		
Skeletal muscle	(3)	(3)	(2)	(4)
<b>Nervous System</b>				
Brain	(50)	(50)	(50)	(50)
Artery, meninges, inflammation, chronic active	1 (2%)			1 (2%)
Peripheral nerve	(2)	(2)	(0)	(0)
Spinal cord	(2)	(2)	(0)	(1)
<b>Respiratory System</b>				
Larynx	(50)	(50)	(49)	(49)
Degeneration, hyaline	1 (2%)			
Inflammation, suppurative		1 (2%)		
Metaplasia, squamous	2 (4%)		1 (2%)	1 (2%)
Artery, inflammation, chronic active	1 (2%)			
Squamous epithelium, necrosis			1 (2%)	
Lung	(50)	(50)	(50)	(49)
Degeneration, hyaline	1 (2%)			
Fibrosis				1 (2%)
Hemorrhage		1 (2%)	1 (2%)	1 (2%)
Inflammation, chronic active	2 (4%)	5 (10%)	3 (6%)	4 (8%)
Alveolar epithelium, hyperplasia	3 (6%)	1 (2%)	4 (8%)	3 (6%)
Alveolus, infiltration cellular, histiocyte	3 (6%)	1 (2%)	3 (6%)	3 (6%)
Perivascular, inflammation, chronic active				2 (4%)
Vein, necrosis		1 (2%)		
Nose	(50)	(50)	(50)	(50)
Foreign body		1 (2%)	1 (2%)	2 (4%)
Hyperostosis		13 (26%)	45 (90%)	48 (96%)
Inflammation, suppurative		1 (2%)	3 (6%)	5 (10%)
Inflammation, chronic active	2 (4%)	1 (2%)		2 (4%)
Olfactory epithelium, accumulation, hyaline droplet	18 (36%)	18 (36%)	13 (26%)	32 (64%)
Olfactory epithelium, metaplasia, respiratory	3 (6%)	29 (58%)	49 (98%)	50 (100%)
Olfactory epithelium, necrosis			2 (4%)	1 (2%)
Respiratory epithelium, accumulation, hyaline droplet	38 (76%)	33 (66%)	29 (58%)	42 (84%)
Respiratory epithelium, hyperplasia	33 (66%)	41 (82%)	39 (78%)	43 (86%)
Respiratory epithelium, metaplasia, squamous	3 (6%)	2 (4%)	3 (6%)	7 (14%)
Respiratory epithelium, necrosis	1 (2%)	3 (6%)	5 (10%)	4 (8%)
Turbinate, atrophy		46 (92%)	50 (100%)	49 (98%)
Trachea	(50)	(50)	(50)	(49)
Degeneration, hyaline	1 (2%)			
Foreign body	1 (2%)			
Inflammation, chronic active	1 (2%)			
Artery, inflammation, chronic active		1 (2%)		

**TABLE D4**  
**Summary of the Incidence of Nonneoplastic Lesions in Female Mice in the 2-Year Inhalation Study**  
**of Vinylidene Chloride**

	Chamber Control	6.25 ppm	12.5 ppm	25 ppm
<b>Special Senses System</b>				
Eye	(50)	(49)	(50)	(49)
Cataract		1 (2%)	1 (2%)	
Degeneration			1 (2%)	
Cornea, inflammation, suppurative				1 (2%)
Cornea, necrosis				1 (2%)
Harderian gland	(50)	(50)	(50)	(48)
Hyperplasia	1 (2%)	1 (2%)	2 (4%)	2 (4%)
<b>Urinary System</b>				
Kidney	(50)	(50)	(50)	(50)
Cyst		2 (4%)	1 (2%)	
Hydronephrosis	2 (4%)		1 (2%)	3 (6%)
Infarct	5 (10%)	5 (10%)	2 (4%)	
Inflammation, chronic active		1 (2%)		
Metaplasia, osseous	3 (6%)		2 (4%)	3 (6%)
Nephropathy	26 (52%)	28 (56%)	38 (76%)	35 (70%)
Artery, inflammation, chronic active	2 (4%)	3 (6%)		1 (2%)
Glomerulus, amyloid deposition		1 (2%)		1 (2%)
Papilla, inflammation, suppurative			1 (2%)	
Renal tubule, necrosis		1 (2%)		
Renal tubule, pigmentation			1 (2%)	
Urinary bladder	(49)	(49)	(48)	(48)
Artery, inflammation, chronic active	1 (2%)			
Transitional epithelium, hyperplasia	1 (2%)			





## APPENDIX E

# GENETIC TOXICOLOGY

BACTERIAL MUTAGENICITY TEST PROTOCOL .....	E-2
MOUSE LYMPHOMA MUTAGENICITY TEST PROTOCOL .....	E-2
<i>DROSOPHILA MELANOGASTER</i> TEST PROTOCOL .....	E-3
MOUSE PERIPHERAL BLOOD MICRONUCLEUS TEST PROTOCOL .....	E-3
EVALUATION PROTOCOL .....	E-4
RESULTS .....	E-4
TABLE E1 Mutagenicity of Vinylidene Chloride in <i>Salmonella typhimurium</i> .....	E-5
TABLE E2 Induction of Trifluorothymidine Resistance in L5178Y Mouse Lymphoma Cells by Vinylidene Chloride .....	E-7
TABLE E3 Induction of Sex-Linked Recessive Lethal Mutations in <i>Drosophila melanogaster</i> by Vinylidene Chloride .....	E-10
TABLE E4 Frequency of Micronuclei in Peripheral Blood Erythrocytes of Mice Following Treatment with Vinylidene Chloride by Inhalation for 3 Months .....	E-11

## GENETIC TOXICOLOGY

### BACTERIAL MUTAGENICITY TEST PROTOCOL

Testing was performed as reported by Mortelmans *et al.* (1986). Vinylidene chloride was sent to the laboratory as a coded aliquot from Radian Corporation (Austin, TX). It was incubated with the *Salmonella typhimurium* tester strains TA98, TA100, TA1535, and TA1537 either in buffer or S9 mix (metabolic activation enzymes and cofactors from Aroclor 1254-induced male Sprague-Dawley rat or Syrian hamster liver) for 20 minutes at 37° C. Top agar supplemented with L-histidine and d-biotin was added, and the contents of the tubes were mixed and poured onto the surfaces of minimal glucose agar plates. Histidine-independent mutant colonies arising on these plates were counted following incubation for 2 days at 37° C.

Each trial consisted of triplicate plates of concurrent positive and negative controls and five doses of vinylidene chloride. The high dose was limited by toxicity. All trials were repeated.

In this assay, a positive response is defined as a reproducible, dose-related increase in histidine-independent (revertant) colonies in any one strain/activation combination. An equivocal response is defined as an increase in revertants that is not dose related, is not reproducible, or is not of sufficient magnitude to support a determination of mutagenicity. A negative response is obtained when no increase in revertant colonies is observed following chemical treatment. There is no minimum percentage or fold increase required for a chemical to be judged positive or weakly positive, although positive calls are typically reserved for increases in mutant colonies that are at least twofold over background.

### MOUSE LYMPHOMA MUTAGENICITY TEST PROTOCOL

The experimental protocol is presented in detail by McGregor *et al.* (1991). Vinylidene chloride was supplied as a coded aliquot by Radian Corporation. The high dose of vinylidene chloride was determined by solubility and toxicity. L5178Y mouse lymphoma cells were maintained at 37° C as suspension cultures in supplemented Fischer's medium; normal cycling time was approximately 10 hours. To reduce the number of spontaneously occurring cells resistant to trifluorothymidine (TFT), subcultures were exposed to medium containing thymidine, hypoxanthine, methotrexate, and glycine for 1 day; to medium containing thymidine, hypoxanthine, and glycine for 1 day; and to normal medium for 3 to 5 days. For cloning, the horse serum content was increased and Noble agar was added.

All treatment levels within an experiment, including concurrent positive and solvent controls, were replicated. Treated cultures contained  $6 \times 10^6$  cells in 10 mL medium. This volume included the S9 fraction in those experiments performed with metabolic activation. Incubation with vinylidene chloride continued for 4 hours, at which time the medium plus vinylidene chloride was removed, and the cells were resuspended in fresh medium and incubated for an additional 2 days to express the mutant phenotype. Cell density was monitored so that log phase growth was maintained. After the 48-hour expression period, cells were plated in medium and soft agar supplemented with TFT for selection of TFT-resistant cells, and cells were plated in nonselective medium and soft agar to determine cloning efficiency. Plates were incubated at 37° C in 5% CO<sub>2</sub> for 10 to 12 days. The test was initially performed without S9. Because a clearly positive response was not obtained, the test was repeated using freshly prepared S9 from the livers of Aroclor 1254-induced male F344 rats.

Minimum criteria for accepting an experiment as valid and a detailed description of the statistical analysis and data evaluation are presented by Caspary *et al.* (1988). All data were evaluated statistically for trend and peak responses. Both responses had to be significant ( $P \leq 0.05$ ) for vinylidene chloride to be considered positive, i.e., capable of inducing TFT resistance. A single significant response led to a call of "questionable," and the absence of both a trend and peak response resulted in a "negative" call.

### ***DROSOPHILA MELANOGASTER* TEST PROTOCOL**

The assays for induction of sex-linked recessive lethal (SLRL) mutations were performed with adult flies as described by Foureman *et al.* (1994). Vinylidene chloride was supplied as a coded aliquot by Radian Corporation. Vinylidene chloride was assayed in the SLRL test by feeding for 3 days to adult Canton-S wild-type males no more than 24 hours old at the beginning of treatment. Because no response was obtained, vinylidene chloride was retested by injection into adult males.

To administer vinylidene chloride by injection, a glass Pasteur pipette was drawn out in a flame to a microfine filament, and the tip was broken off to allow delivery of the test solution. Injection was performed either manually, by attaching a rubber bulb to the other end of the pipette and forcing through sufficient solution (0.2 to 0.3  $\mu$ L) to slightly distend the abdomen of the fly, or by attaching the pipette to a microinjector that automatically delivered a calibrated volume. Flies were anesthetized with ether and immobilized on a strip of tape. Injection into the thorax, under the wing, was performed with the aid of a dissecting microscope.

Toxicity tests were performed to set concentrations of vinylidene chloride at a level that would induce 30% mortality after 72 hours of feeding or 24 hours after injection, while keeping induced sterility at an acceptable level. Canton-S males were allowed to feed for 72 hours on a solution of vinylidene chloride in 5% sucrose. In the injection experiments, 24- to 72-hour-old Canton-S males were treated with a solution of vinylidene chloride dissolved in ethanol and allowed to recover for 24 hours. A concurrent ethanol control group was also included. In the adult exposures, treated males were mated to three *Basc* females for 3 days and were given fresh females at 2-day intervals to produce three matings of 3, 2, and 2 days (in each case, sample sperm from successive matings was treated at successively earlier postmeiotic stages).  $F_1$  heterozygous females were mated with their siblings and then placed in individual vials.  $F_1$  daughters from the same parental male were kept together to identify clusters. (A cluster occurs when a number of mutants from a given male result from a single spontaneous premeiotic mutation event and is identified when the number of mutants from that male exceeds the number predicted by a Poisson distribution.) If a cluster was identified, all data from the male in question were discarded. Presumptive lethal mutations were identified as vials containing fewer than 5% of the expected number of wild-type males after 17 days; these were retested to confirm the response.

SLRL data were analyzed by simultaneous comparison with the concurrent and historical controls (Mason *et al.*, 1992) using a normal approximation to the binomial test (Margolin *et al.*, 1983). A test result was considered positive if the P value was less than or equal to 0.01 and the mutation frequency in the tested group was greater than 0.10% or if the P value was less than or equal to 0.05 and the frequency in the treatment group was greater than 0.15%. A test was considered to be inconclusive if the P value was between 0.05 and 0.01 but the frequency in the treatment group was between 0.10% and 0.15% or if the P value was between 0.10 and 0.05 but the frequency in the treatment group was greater than 0.10%. A test was considered negative if the P value was greater than or equal to 0.10 or if the frequency in the treatment group was less than 0.10%.

### **MOUSE PERIPHERAL BLOOD MICRONUCLEUS TEST PROTOCOL**

A detailed discussion of this assay is presented by MacGregor *et al.* (1990). At the end of the 3-month toxicity study, peripheral blood samples were obtained from male and female B6C3F1/N mice. Smears were immediately prepared and fixed in absolute methanol. Slides were sent to the genetic toxicity testing laboratory where they were stained with acridine orange and coded. Slides were scanned to determine the frequency of micronuclei in 2,000 normochromatic erythrocytes (NCEs; mature erythrocytes) per animal. In addition, the percentage of polychromatic erythrocytes (PCEs; reticulocytes) among the total erythrocyte population in the peripheral blood was scored for each dose group as a measure of bone marrow toxicity.

The results were tabulated as the mean of the pooled results from all animals within a treatment group plus or minus the standard error of the mean. The frequency of micronucleated cells among NCEs was analyzed by a statistical software package that tested for increasing trend over exposure groups with a one-tailed Cochran-Armitage trend test, followed by pairwise comparisons between each exposed group and the control group. In the presence of excess binomial variation, as detected by a binomial dispersion test, the binomial variance of the Cochran-Armitage test was adjusted upward in proportion to the excess variation. In the micronucleus test, an individual trial is considered positive if the trend test P value is less than or equal to 0.025 or if the P value for any single exposed

group is less than or equal to 0.025 divided by the number of exposed groups. A final call of positive for micronucleus induction is preferably based on reproducibly positive trials (as noted above). Results of the 3-month study were accepted without repeat tests, because additional test data could not be obtained. Ultimately, the final call is determined by the scientific staff after considering the results of statistical analyses, the reproducibility of any effects observed, and the magnitudes of those effects.

## EVALUATION PROTOCOL

These are the basic guidelines for arriving at an overall assay result for assays performed by the National Toxicology Program. Statistical as well as biological factors are considered. For an individual assay, the statistical procedures for data analysis have been described in the preceding protocols. There have been instances, however, in which multiple samples of a chemical were tested in the same assay, and different results were obtained among these samples and/or among laboratories. Results from more than one aliquot or from more than one laboratory are not simply combined into an overall result. Rather, all the data are critically evaluated, particularly with regard to pertinent protocol variations, in determining the weight of evidence for an overall conclusion of chemical activity in an assay. In addition to multiple aliquots, the *in vitro* assays have another variable that must be considered in arriving at an overall test result. *In vitro* assays are conducted with and without exogenous metabolic activation. Results obtained in the absence of activation are not combined with results obtained in the presence of activation; each testing condition is evaluated separately. The summary table in the Abstract of this Technical Report presents a result that represents a scientific judgement of the overall evidence for activity of the chemical in an assay.

## RESULTS

Vinylidene chloride tested over a concentration range of 33.3 to 6,666 µg/plate was not mutagenic in *S. typhimurium* strains TA98, TA100, TA1535, or TA1537 when testing occurred with or without exogenous metabolic activation (10% induced hamster or rat liver S9 mix) using a preincubation protocol (Table E1; Mortelmans *et al.*, 1986). However, when tested in a closed system as a vapor, vinylidene chloride (0.16% to 2.5% in air) demonstrated clear mutagenic activity in mouse lymphoma L5178Y *tk*<sup>+/+</sup> cells in trials conducted with 10% induced male rat liver S9 mix (Table E2; McGregor *et al.*, 1991); in the absence of S9, a positive response was seen at a concentration of 30% vinylidene chloride in one of three trials. *In vivo*, no increase in sex-linked recessive lethal mutations was seen in germ cells of adult male *Drosophila melanogaster* exposed via feeding (20,000 or 25,000 ppm) or injection (5,000 ppm) to vinylidene chloride (Table E3; Foureman *et al.*, 1994). No increase in the frequency of micronucleated NCEs was observed in peripheral blood of male or female B6C3F1/N mice exposed to vinylidene chloride by inhalation for a period of 3 months, and no change in the percentage of immature PCEs (reticulocytes) was seen in these mice following exposure to vinylidene chloride, suggesting the absence of chemical-induced bone marrow toxicity (Table E4).

**TABLE E1**  
**Mutagenicity of Vinylidene Chloride in *Salmonella typhimurium*<sup>a</sup>**

Strain	Dose (µg/plate)	Without S9	Without S9	Without S9	With 10% hamster S9	With 10% hamster S9	With 10% hamster S9
<b>TA100</b>							
	0	99 ± 10	81 ± 8	91 ± 3	96 ± 10	93 ± 6	
	33.3			95 ± 7		97 ± 7	
	100	90 ± 9	85 ± 5	91 ± 6	92 ± 6	98 ± 7	
	333.3	87 ± 6	80 ± 12	97 ± 7	94 ± 9	104 ± 7	
	1,000	87 ± 4	63 ± 4	106 ± 2	112 ± 5	103 ± 10	
	3,333	81 ± 6	79 ± 3 <sup>b</sup>	82 ± 4	85 ± 6 <sup>b</sup>	51 ± 12 <sup>b</sup>	
	6,666	89 ± 4	78 ± 3 <sup>b</sup>		41 ± 21 <sup>b</sup>		
Trial summary		Negative	Negative	Negative	Negative	Negative	
Positive control <sup>c</sup>		130 ± 30	376 ± 18	500 ± 11	1,238 ± 91	290 ± 21	
		<b>With 10% rat S9</b>	<b>With 10% rat S9</b>	<b>With 10% rat S9</b>			
	0	92 ± 4	107 ± 3	88 ± 7			
	33.3			97 ± 7			
	100	106 ± 7	98 ± 4	97 ± 6			
	333.3	115 ± 8	86 ± 11	104 ± 4			
	1,000	100 ± 12	105 ± 10	120 ± 9			
	3,333	87 ± 2 <sup>b</sup>	84 ± 3 <sup>b</sup>	110 ± 4			
	6,666	71 ± 5 <sup>b</sup>	81 ± 2 <sup>b</sup>				
Trial summary		Negative	Negative	Negative			
Positive control		604 ± 40	826 ± 36	1,066 ± 12			
<b>TA98</b>							
		<b>Without S9</b>	<b>Without S9</b>	<b>Without S9</b>			
	0	17 ± 2	19 ± 1	14 ± 3	25 ± 1	29 ± 2	22 ± 2
	33.3			8 ± 2			20 ± 2
	100	15 ± 2	21 ± 4	15 ± 4	24 ± 3	28 ± 6	20 ± 2
	333.3	17 ± 4	22 ± 7	13 ± 0	28 ± 2	33 ± 3	20 ± 2
	1,000	21 ± 2	15 ± 2	17 ± 2	35 ± 6	36 ± 2	22 ± 2
	3,333	23 ± 4	12 ± 1	16 ± 6	37 ± 3	28 ± 1 <sup>b</sup>	10 ± 5 <sup>b</sup>
	6,666	13 ± 3	15 ± 5 <sup>b</sup>		44 ± 4	12 ± 4 <sup>b</sup>	
Trial summary		Negative	Negative	Negative	Negative	Negative	Negative
Positive control		645 ± 7	655 ± 70	693 ± 39	1,292 ± 28	198 ± 10	199 ± 8
		<b>With 10% rat S9</b>	<b>With 10% rat S9</b>	<b>With 10% rat S9</b>			
	0	27 ± 3	41 ± 2	22 ± 3			
	33.3			28 ± 5			
	100	25 ± 2	36 ± 2	31 ± 6			
	333.3	22 ± 3	35 ± 6	25 ± 4			
	1,000	23 ± 4	37 ± 5	24 ± 3			
	3,333	20 ± 2 <sup>b</sup>	26 ± 3 <sup>b</sup>	19 ± 1			
	6,666	20 ± 5 <sup>b</sup>	23 ± 3 <sup>b</sup>				
Trial summary		Negative	Negative	Negative			
Positive control		428 ± 24	542 ± 13	787 ± 53			

**TABLE E1**  
**Mutagenicity of Vinylidene Chloride in *Salmonella typhimurium***

Strain	Dose (µg/plate)	Without S9	Without S9	Without S9	With 10% hamster S9	With 10% hamster S9	With 10% hamster S9
<b>TA1535</b>							
	0	17 ± 2	18 ± 3	8 ± 1	10 ± 0	9 ± 1	12 ± 3
	33.3			10 ± 2			8 ± 0
	100	18 ± 1	17 ± 1	7 ± 1	14 ± 0	13 ± 3	7 ± 2
	333.3	19 ± 4	14 ± 3	6 ± 1	10 ± 3	11 ± 2	7 ± 1
	1,000	20 ± 6	15 ± 1	8 ± 3	16 ± 1	17 ± 1	6 ± 2
	3,333	20 ± 0	18 ± 1 <sup>b</sup>	9 ± 0	22 ± 2	5 ± 0 <sup>b</sup>	4 ± 2 <sup>b</sup>
	6,666	19 ± 3	19 ± 3 <sup>b</sup>		23 ± 2	8 ± 3 <sup>b</sup>	
Trial summary		Negative	Negative	Negative	Negative	Negative	Negative
Positive control		19 ± 1	300 ± 21	337 ± 23	374 ± 16	326 ± 21	186 ± 13
		<b>With 10% rat S9</b>	<b>With 10% rat S9</b>	<b>With 10% rat S9</b>			
	0	6 ± 1	11 ± 3	5 ± 2			
	33.3			6 ± 0			
	100	7 ± 1	7 ± 2	8 ± 1			
	333.3	10 ± 2	5 ± 0	10 ± 3			
	1,000	12 ± 1	11 ± 2	9 ± 2			
	3,333	7 ± 1 <sup>b</sup>	8 ± 1 <sup>b</sup>	5 ± 1			
	6,666	8 ± 2 <sup>b</sup>	6 ± 2 <sup>b</sup>				
Trial summary		Negative	Negative	Negative			
Positive control		389 ± 11	355 ± 11	387 ± 26			
<b>TA1537</b>							
		<b>Without S9</b>	<b>Without S9</b>	<b>Without S9</b>			
	0	7 ± 1	6 ± 1	6 ± 0	16 ± 2	10 ± 2	5 ± 1
	33.3			7 ± 1			8 ± 1
	100	6 ± 1	8 ± 1	5 ± 1	19 ± 3	18 ± 3	9 ± 2
	333.3	9 ± 1	8 ± 1	4 ± 1	15 ± 1	19 ± 3	5 ± 1
	1,000	9 ± 1	5 ± 2	4 ± 1	18 ± 1	15 ± 0	7 ± 4
	3,333	9 ± 1	5 ± 1 <sup>b</sup>	5 ± 2	20 ± 2	14 ± 4 <sup>b</sup>	4 ± 0 <sup>b</sup>
	6,666	6 ± 1	6 ± 1 <sup>b</sup>		14 ± 4	5 ± 2 <sup>b</sup>	
Trial summary		Negative	Negative	Negative	Negative	Negative	Negative
Positive control		227 ± 44	245 ± 42	258 ± 17	556 ± 24	487 ± 35	362 ± 20
		<b>With 10% rat S9</b>	<b>With 10% rat S9</b>	<b>With 10% rat S9</b>			
	0	14 ± 1	15 ± 0	6 ± 1			
	33.3			12 ± 2			
	100	10 ± 1	13 ± 2	5 ± 2			
	333.3	6 ± 1	13 ± 1	6 ± 1			
	1,000	9 ± 1	11 ± 2	6 ± 1			
	3,333	11 ± 1 <sup>b</sup>	13 ± 6 <sup>b</sup>	5 ± 1			
	6,666	10 ± 3 <sup>b</sup>	8 ± 1 <sup>b</sup>				
Trial summary		Negative	Negative	Negative			
Positive control		365 ± 20	297 ± 29	461 ± 16			

<sup>a</sup> Study performed at SRI International. Data are presented as revertants/plate (mean ± standard error) from three plates. The detailed protocol and these data are presented by Mortelmans *et al.* (1986). 0 µg/plate was the solvent control.

<sup>b</sup> Slight toxicity

<sup>c</sup> The positive controls in the absence of metabolic activation were sodium azide (TA100 and TA1535), 9-aminoacridine (TA1537), and 4-nitro-*o*-phenylenediamine (TA98). The positive control for metabolic activation with all strains was 2-aminoanthracene.

**TABLE E2**  
**Induction of Trifluorothymidine Resistance in L5178Y Mouse Lymphoma Cells by Vinylidene Chloride<sup>a</sup>**

Compound	Concentration (%)	Cloning Efficiency (%)	Relative Total Growth (%)	Mutant Count	Mutant Fraction <sup>b</sup>	Average Mutant Fraction
<b>-S9</b>						
<b>Trial 1</b>						
Trial call: Questionable						
Air <sup>c</sup>		81	101	41	17	
		63	103	48	26	
		52	80	20	13	
		62	117	57	31	22
Vinylidene chloride	1	78	127	72	31	
		71 <sup>d</sup>	134	38	18	24
	2	0 <sup>e</sup>	0	58	0	
		65	108	64	33	
	4	69	98	70	34	
		69	91	81	39	37*
	6	70	117	53	25	
		58	92	59	34	29
	8	71	107	74	35	
		76	128	76	33	34
Methyl methanesulfonate <sup>f</sup>	15 µg/mL	27 <sup>d</sup>	27	75	93	
		24	23	57	81	87*
<b>-S9</b>						
<b>Trial 2</b>						
Trial call: Inconclusive						
Air		85	100	63	25	
		78	99	40	17	
		79	109	68	29	
		76	93	62	27	25
Vinylidene chloride	3	68	94	32	16	
		65	79	46	24	20
	6	72	101	28	13	
		74	92	39	18	15
	9	61	88	30	16	
		67	98	31	15	16
	12	66	91	22	11	
		68	83	28	14	12
	15	67	59	27	13	
		71	74	40	19	16
Methyl methanesulfonate	15 µg/mL	35	21	159	152	
		33	21	154	158	155*



**TABLE E2**  
**Induction of Trifluorothymidine Resistance in L5178Y Mouse Lymphoma Cells by Vinylidene Chloride**

Compound	Concentration (%)	Cloning Efficiency (%)	Relative Total Growth (%)	Mutant Count	Mutant Fraction	Average Mutant Fraction
<b>-S9</b>						
<b>Trial 3</b>						
Trial cell: Positive						
Air		73	130	31	14	
		79	89	52	22	
		71	78	133	62	
		79	103	66	28	32
Vinylidene chloride	10	60	77	61	34	
		63	88	92	49	41
	15	82	69	66	27	
		60	60	60	33	30
	20	65	94	47	24	
		56	81	70	42	33
	25	64	93	60	31	
		63	66	53	28	30
	30	43	22	63	49	
		32	19	66	69	59*
Methyl methanesulfonate	15 µg/mL	16	18	137	282	
		27	18	202	252	267*
<b>+S9</b>						
<b>Trial 1</b>						
Trial cell: Positive						
Air		68	88	92	45	
		77	115	94	41	
		67	97	97	48	
		73	100	107	49	46
Vinylidene chloride	0.16	68	69	201	99	
		81	70	207	86	92*
	0.31	46	42	210	153	
		70	79	213	102	127*
	0.63	52	37	292	188	
		47	37	299	211	200*
	1.25	31	22	308	337	
		36	25	294	271	304*
	2.5	45	22	305	227	
		41	16	359	290	258*
Methyl cholanthrene <sup>f</sup>	2.5 µg/mL	34	15	458	456	
		33	20	393	399	427*

**TABLE E2**  
**Induction of Trifluorothymidine Resistance in L5178Y Mouse Lymphoma Cells by Vinylidene Chloride<sup>a</sup>**

Compound	Concentration (%)	Cloning Efficiency (%)	Relative Total Growth (%)	Mutant Count	Mutant Fraction	Average Mutant Fraction
<b>+S9</b>						
<b>Trial 2</b>						
Trial call: Positive						
Air		79	127	124	52	
		60	86	118	66	
		81	87	115	48	
		83 <sup>d</sup>	100	140	56	56
Vinylidene chloride	1	57	25	293	171	
		35	13	251	237	204*
	1.5	23	6	174	249	
		44	12	297	227	238*
	2	46	11	264	193	
		33	10	226	228	211*
	2.5	22	8	134	205	
		43	13	251	195	200*
	3.5	8 <sup>e</sup>	1	184	783	
		4 <sup>e</sup>	1	87	757	
Methyl cholanthrene	2.5 µg/mL	24	9	495	697	
		28	11	422	502	600*

\* Positive response ( $P \leq 0.05$ ) versus the chamber control

<sup>a</sup> Study was performed at Inveresk Research International. The detailed protocol and these data are presented by McGregor *et al.* (1991).

<sup>b</sup> Mutant fraction = mutant cells/ $10^6$  clonable cells

<sup>c</sup> Chamber control

<sup>d</sup> Reduced sample size due to contamination and loss of one culture

<sup>e</sup> Rejected due to failure to meet quality control criteria.

<sup>f</sup> Positive control

**TABLE E3**  
**Induction of Sex-Linked Recessive Lethal Mutations in *Drosophila melanogaster***  
**by Vinylidene Chloride<sup>a</sup>**

Route of Exposure	Dose (ppm)	Incidence of Death (%)	Incidence of Sterility (%)	No. Lethals Mating 1	No. Lethals Mating 2	No. Lethals Mating 3	Total <sup>b</sup>
Feeding	25,000	13	8	0/724	0/471	1/372	1/1,567 (0.06%)
	0			0/854	0/694	0/449	0/1,997 (0.00%)
Feeding	20,000	17	4	1/1,356	1/1,215	2/1,146	4/3,717 (0.11%)
	0			1/1,247	0/1,014	1/1,020	2/3,281 (0.06%) P=0.129
Injection	5,000	1	15	0/2,204	1/1653	0/1,179	1/5,036 (0.02%)
	0			1/2,132	1/2023	0/1,104	2/5,259 (0.04%) P=0.705 <sup>c</sup>

<sup>a</sup> Study was performed at the University of Wisconsin-Madison. The detailed protocol and these data are presented by Foureman *et al.* (1994). The mean mutant frequency from 518 negative control experiments is 0.074% (Mason *et al.*, 1992).

<sup>b</sup> Total number of lethal mutations/total number of X chromosomes tested for three mating trials

<sup>c</sup> Significance of total number of lethal mutations/total number of X chromosomes tested by a normal approximation to the binomial test (Margolin *et al.*, 1983).

**TABLE E4**  
**Frequency of Micronuclei in Peripheral Blood Erythrocytes of Mice**  
**Following Treatment with Vinylidene Chloride by Inhalation for 3 Months<sup>a</sup>**

	Dose (ppm)	Number of Mice with Erythrocytes Scored	Micronucleated NCEs/1,000 NCEs <sup>b</sup>	P Value <sup>c</sup>	PCEs <sup>b</sup> (%)
<b>Male</b>					
Air <sup>d</sup>		5	2.40 ± 0.33		2.90 ± 0.34
Vinylidene chloride	6.25	5	2.00 ± 0.32	0.7270	2.84 ± 0.45
	12.5	5	1.40 ± 0.40	0.9478	2.58 ± 0.32
	25	5	3.20 ± 0.70	0.1422	3.08 ± 0.14
	50	5	2.10 ± 0.58	0.6728	2.96 ± 0.22
			P=0.363 <sup>e</sup>		
<b>Female</b>					
Air		5	1.20 ± 0.30		3.10 ± 0.38
Vinylidene chloride	6.25	5	0.90 ± 0.43	0.6917	2.88 ± 0.41
	12.5	5	1.40 ± 0.56	0.3821	2.74 ± 0.31
	25	5	1.10 ± 0.43	0.5634	2.56 ± 0.46
	50	5	1.80 ± 0.44	0.2010	3.14 ± 0.49
	100	5	1.00 ± 0.50	0.6278	2.80 ± 0.31
			P=0.481		

<sup>a</sup> Study was performed at ILS, Inc. The detailed protocol is presented by MacGregor *et al.* (1990). NCE=normochromatic erythrocyte; PCE=polychromatic erythrocyte

<sup>b</sup> Mean ± standard error

<sup>c</sup> Pairwise comparison with the chamber control group; exposed group values are significant at  $P \leq 0.006$  for males and  $P \leq 0.005$  for females.

<sup>d</sup> Chamber control

<sup>e</sup> Significance of micronucleated NCEs/1,000 NCEs tested by the one-tailed trend test; significant at  $P \leq 0.025$



## APPENDIX F CLINICAL PATHOLOGY RESULTS

<b>TABLE F1</b>	<b>Hematology and Clinical Chemistry Data for Rats in the 3-Month Inhalation Study of Vinylidene Chloride .....</b>	<b>F-2</b>
<b>TABLE F2</b>	<b>Hematology Data for Mice in the 3-Month Inhalation Study of Vinylidene Chloride .....</b>	<b>F-8</b>

**TABLE F1**  
**Hematology and Clinical Chemistry Data for Rats in the 3-Month Inhalation Study**  
**of Vinylidene Chloride<sup>a</sup>**

	Chamber Control	6.25 ppm	12.5 ppm	25 ppm	50 ppm	100 ppm
<b>Male</b>						
Hematology						
n						
Day 3	10	10	9	10	10	10
Day 23	10	10	10	10	10	10
Week 14	10	10	10	10	10	10
Hematocrit (manual) (%)						
Day 3	46.5 ± 0.5	46.5 ± 0.4	45.7 ± 0.3	46.1 ± 0.2	47.4 ± 0.5	48.4 ± 0.4*
Day 23	48.5 ± 0.3	48.5 ± 0.3	47.7 ± 0.3	48.2 ± 0.6	48.1 ± 0.3	48.4 ± 0.4
Week 14	49.7 ± 0.3	49.5 ± 0.5	48.7 ± 0.4	49.9 ± 0.4	49.8 ± 0.3	49.5 ± 0.2
Packed cell volume (auto) (%)						
Day 3	45.2 ± 0.5	45.0 ± 0.5	44.5 ± 0.5	44.6 ± 0.3	45.8 ± 0.6	46.9 ± 0.5
Day 23	47.7 ± 0.3	47.3 ± 0.3	46.4 ± 0.4	47.2 ± 0.5	47.5 ± 0.4	47.8 ± 0.4
Week 14	49.1 ± 0.2	48.3 ± 0.5	47.8 ± 0.4	49.0 ± 0.3	49.0 ± 0.3	48.9 ± 0.4
Hemoglobin (g/dL)						
Day 3	13.9 ± 0.2	13.9 ± 0.2	13.8 ± 0.2	14.0 ± 0.2	14.3 ± 0.2	14.8 ± 0.1**
Day 23	15.2 ± 0.1	15.1 ± 0.1	14.8 ± 0.1	15.0 ± 0.2	15.2 ± 0.1	15.2 ± 0.1
Week 14	15.7 ± 0.1	15.6 ± 0.1	15.3 ± 0.1	15.6 ± 0.1	15.7 ± 0.1	15.5 ± 0.1
Erythrocytes (10 <sup>6</sup> /μL)						
Day 3	7.32 ± 0.08	7.27 ± 0.09	7.19 ± 0.07	7.34 ± 0.07	7.48 ± 0.09	7.79 ± 0.09**
Day 23	8.29 ± 0.06	8.16 ± 0.07	7.99 ± 0.07*	8.12 ± 0.10	8.14 ± 0.07	8.19 ± 0.09
Week 14	9.21 ± 0.05	9.11 ± 0.06	9.01 ± 0.08	9.17 ± 0.05	9.25 ± 0.05	9.08 ± 0.07
Reticulocytes (10 <sup>6</sup> /μL)						
Day 3	0.32 ± 0.02	0.40 ± 0.03	0.34 ± 0.02	0.33 ± 0.02	0.33 ± 0.02	0.30 ± 0.02
Day 23	0.25 ± 0.02	0.27 ± 0.02	0.30 ± 0.02 <sup>b</sup>	0.30 ± 0.02 <sup>c</sup>	0.33 ± 0.01**	0.31 ± 0.02 <sup>b**</sup>
Week 14	0.17 ± 0.01	0.20 ± 0.01	0.18 ± 0.01	0.18 ± 0.01	0.19 ± 0.01	0.21 ± 0.01
Nucleated erythrocytes/100 leukocytes						
Day 3	1.1 ± 0.4	0.8 ± 0.2	0.8 ± 0.3	0.6 ± 0.3	0.2 ± 0.1	0.4 ± 0.2
Day 23	0.1 ± 0.1	0.2 ± 0.1	0.0 ± 0.0	0.0 ± 0.0	0.1 ± 0.1	0.2 ± 0.1
Week 14	0.2 ± 0.1	0.0 ± 0.0	0.5 ± 0.2	0.2 ± 0.1	0.1 ± 0.1	0.5 ± 0.2
Mean cell volume (fL)						
Day 3	61.8 ± 0.4	61.9 ± 0.2	61.8 ± 0.3	60.9 ± 0.2	61.2 ± 0.4	60.2 ± 0.4**
Day 23	57.6 ± 0.3	58.0 ± 0.2	58.0 ± 0.2	58.2 ± 0.2	58.4 ± 0.2	58.4 ± 0.3
Week 14	53.3 ± 0.1	53.0 ± 0.2	53.1 ± 0.2	53.4 ± 0.2	53.0 ± 0.2	53.9 ± 0.2
Mean cell hemoglobin (pg)						
Day 3	19.0 ± 0.1	19.2 ± 0.1	19.2 ± 0.1	19.0 ± 0.1	19.2 ± 0.1	18.9 ± 0.1
Day 23	18.4 ± 0.1	18.5 ± 0.1	18.5 ± 0.1	18.5 ± 0.1	18.7 ± 0.1	18.6 ± 0.1
Week 14	17.0 ± 0.1	17.0 ± 0.1	17.1 ± 0.0	17.0 ± 0.1	17.0 ± 0.1	17.1 ± 0.1
Mean cell hemoglobin concentration (g/dL)						
Day 3	30.8 ± 0.1	30.9 ± 0.1	31.1 ± 0.2	31.3 ± 0.2	31.3 ± 0.2*	31.5 ± 0.1**
Day 23	31.9 ± 0.1	31.9 ± 0.1	31.9 ± 0.1	31.9 ± 0.1	32.0 ± 0.1	31.8 ± 0.1
Week 14	32.0 ± 0.1	32.2 ± 0.2	32.1 ± 0.1	31.9 ± 0.1	32.1 ± 0.1	31.8 ± 0.1
Platelets (10 <sup>3</sup> /μL)						
Day 3	855.5 ± 22.3	902.4 ± 19.2	852.7 ± 15.1	851.9 ± 9.8	869.6 ± 17.4	899.3 ± 18.3
Day 23	717.7 ± 24.5	743.1 ± 14.4	732.3 ± 20.0	706.2 ± 14.9	728.2 ± 16.9	757.9 ± 13.2
Week 14	623.1 ± 13.9	644.4 ± 8.8	618.2 ± 11.0	591.4 ± 10.6	617.2 ± 18.6	615.0 ± 9.8
Leukocytes (10 <sup>3</sup> /μL)						
Day 3	8.76 ± 0.47	9.27 ± 0.32	9.60 ± 0.32	9.36 ± 0.24	9.41 ± 0.44	9.11 ± 0.42
Day 23	8.30 ± 0.55	7.67 ± 0.55	8.35 ± 0.42	7.50 ± 0.45	8.58 ± 0.67	8.06 ± 0.59
Week 14	6.19 ± 0.35	6.92 ± 0.43	6.05 ± 0.44	6.02 ± 0.33	6.60 ± 0.45	6.17 ± 0.31
Segmented neutrophils (10 <sup>3</sup> /μL)						
Day 3	0.75 ± 0.03	0.95 ± 0.05	1.29 ± 0.08**	1.12 ± 0.06**	0.96 ± 0.04	0.79 ± 0.04
Day 23	0.94 ± 0.06	0.94 ± 0.03	0.92 ± 0.03	0.87 ± 0.07	0.94 ± 0.05	0.97 ± 0.08
Week 14	1.13 ± 0.06	1.17 ± 0.07	1.12 ± 0.07	1.06 ± 0.03	1.15 ± 0.06	1.05 ± 0.05

**TABLE F1**  
**Hematology and Clinical Chemistry Data for Rats in the 3-Month Inhalation Study**  
**of Vinylidene Chloride**

	Chamber Control	6.25 ppm	12.5 ppm	25 ppm	50 ppm	100 ppm
<b>Male (continued)</b>						
Hematology (continued)						
n						
Day 3	10	10	9	10	10	10
Day 23	10	10	10	10	10	10
Week 14	10	10	10	10	10	10
Bands (10 <sup>3</sup> /μL)						
Day 3	0.00 ± 0.00	0.00 ± 0.00	0.00 ± 0.00	0.00 ± 0.00	0.00 ± 0.00	0.00 ± 0.00
Day 23	0.00 ± 0.00	0.00 ± 0.00	0.00 ± 0.00	0.00 ± 0.00	0.00 ± 0.00	0.00 ± 0.00
Week 14	0.00 ± 0.00	0.00 ± 0.00	0.00 ± 0.00	0.00 ± 0.00	0.00 ± 0.00	0.00 ± 0.00
Lymphocytes (10 <sup>3</sup> /μL)						
Day 3	7.72 ± 0.45	8.08 ± 0.28	8.05 ± 0.30	8.00 ± 0.20	8.18 ± 0.42	7.99 ± 0.41
Day 23	7.11 ± 0.53	6.51 ± 0.51	7.14 ± 0.39	6.38 ± 0.47	7.21 ± 0.58	6.82 ± 0.53
Week 14	4.54 ± 0.34	5.30 ± 0.40	4.34 ± 0.38	4.47 ± 0.34	4.99 ± 0.40	4.69 ± 0.35
Monocytes (10 <sup>3</sup> /μL)						
Day 3	0.18 ± 0.03	0.14 ± 0.03	0.16 ± 0.07	0.11 ± 0.04	0.15 ± 0.03	0.20 ± 0.05
Day 23	0.16 ± 0.09	0.15 ± 0.04	0.20 ± 0.09	0.16 ± 0.07	0.34 ± 0.12	0.18 ± 0.06
Week 14	0.42 ± 0.09	0.32 ± 0.08	0.47 ± 0.07	0.38 ± 0.06	0.34 ± 0.10	0.34 ± 0.07
Basophils (10 <sup>3</sup> /μL)						
Day 3	0.015 ± 0.003	0.012 ± 0.003	0.010 ± 0.002	0.012 ± 0.003	0.012 ± 0.005	0.020 ± 0.005
Day 23	0.008 ± 0.005	0.005 ± 0.002	0.007 ± 0.003	0.009 ± 0.002	0.016 ± 0.005	0.006 ± 0.002
Week 14	0.010 ± 0.002	0.013 ± 0.003	0.014 ± 0.004	0.011 ± 0.002	0.012 ± 0.005	0.008 ± 0.001
Eosinophils (10 <sup>3</sup> /μL)						
Day 3	0.09 ± 0.01	0.09 ± 0.01	0.09 ± 0.01	0.12 ± 0.03	0.11 ± 0.01	0.11 ± 0.02
Day 23	0.08 ± 0.01	0.06 ± 0.01	0.09 ± 0.01	0.08 ± 0.01	0.09 ± 0.01	0.09 ± 0.01
Week 14	0.09 ± 0.01	0.12 ± 0.01	0.10 ± 0.01	0.09 ± 0.01	0.11 ± 0.01	0.09 ± 0.01
Clinical Chemistry						
n	10	10	10	10	10	10
Urea nitrogen (mg/dL)						
Day 3	8.9 ± 0.4	8.5 ± 0.4	9.0 ± 0.6	9.9 ± 0.4	10.7 ± 0.4*	14.9 ± 0.6**
Day 23	10.5 ± 0.5	9.7 ± 0.3	9.9 ± 0.4	11.7 ± 0.5	12.2 ± 0.4*	13.4 ± 0.3**
Week 14	15.6 ± 0.4	14.5 ± 0.2	13.9 ± 0.3**	14.9 ± 0.3	15.6 ± 0.6	13.9 ± 0.2**
Creatinine (mg/dL)						
Day 3	0.23 ± 0.02	0.23 ± 0.02	0.25 ± 0.02	0.25 ± 0.02	0.25 ± 0.02	0.27 ± 0.02
Day 23	0.27 ± 0.02	0.28 ± 0.01	0.27 ± 0.02	0.28 ± 0.02	0.30 ± 0.00	0.30 ± 0.02
Week 14	0.40 ± 0.00	0.41 ± 0.02	0.38 ± 0.01	0.43 ± 0.02	0.44 ± 0.02	0.44 ± 0.02
Glucose (mg/dL)						
Day 3	141 ± 8	141 ± 2	138 ± 5	140 ± 4	127 ± 3	125 ± 3*
Day 23	119 ± 4	129 ± 4	128 ± 3	119 ± 6	120 ± 5	106 ± 3
Week 14	127 ± 2	123 ± 2	126 ± 3	135 ± 11	128 ± 6	121 ± 2
Total protein (g/dL)						
Day 3	6.2 ± 0.1	6.2 ± 0.0	6.2 ± 0.1	6.3 ± 0.1	6.3 ± 0.1	6.5 ± 0.1**
Day 23	6.5 ± 0.0	6.6 ± 0.0	6.6 ± 0.1	6.5 ± 0.0	6.6 ± 0.1	6.8 ± 0.0**
Week 14	7.5 ± 0.1	7.5 ± 0.0	7.4 ± 0.1	7.4 ± 0.1	7.6 ± 0.1	7.6 ± 0.1
Albumin (g/dL)						
Day 3	4.5 ± 0.1	4.5 ± 0.0	4.4 ± 0.0	4.4 ± 0.1	4.5 ± 0.0	4.6 ± 0.1
Day 23	4.6 ± 0.0	4.6 ± 0.0	4.6 ± 0.0	4.6 ± 0.0	4.6 ± 0.0	4.7 ± 0.0*
Week 14	5.0 ± 0.0	4.9 ± 0.0	4.9 ± 0.0*	4.9 ± 0.0	5.0 ± 0.0	5.0 ± 0.0
Globulin (g/dL)						
Day 3	1.7 ± 0.0	1.7 ± 0.0	1.8 ± 0.0	1.8 ± 0.0	1.9 ± 0.0*	1.9 ± 0.0**
Day 23	1.9 ± 0.0	2.0 ± 0.0	2.0 ± 0.0	1.9 ± 0.0	2.0 ± 0.0*	2.1 ± 0.0**
Week 14	2.5 ± 0.0	2.5 ± 0.0	2.5 ± 0.0	2.4 ± 0.0	2.6 ± 0.0	2.6 ± 0.0



**TABLE F1**  
**Hematology and Clinical Chemistry Data for Rats in the 3-Month Inhalation Study**  
**of Vinylidene Chloride**

	Chamber Control	6.25 ppm	12.5 ppm	25 ppm	50 ppm	100 ppm
<b>Male (continued)</b>						
Clinical Chemistry (continued)						
n	10	10	10	10	10	10
A/G ratio (albumin/globulin ratio)						
Day 3	2.6 ± 0.0	2.6 ± 0.0	2.5 ± 0.0	2.5 ± 0.0*	2.4 ± 0.0**	2.4 ± 0.0**
Day 23	2.4 ± 0.0	2.4 ± 0.0	2.3 ± 0.0	2.4 ± 0.0	2.3 ± 0.0	2.3 ± 0.0
Week 14	2.0 ± 0.0	2.0 ± 0.0	2.0 ± 0.0	2.0 ± 0.0	1.9 ± 0.0	1.9 ± 0.0
Alanine aminotransferase (IU/L)						
Day 3	54 ± 1	54 ± 1	53 ± 2	53 ± 1	61 ± 1**	70 ± 4**
Day 23	44 ± 1	45 ± 1	42 ± 1	43 ± 1	45 ± 1	63 ± 4**
Week 14	129 ± 18	113 ± 5	97 ± 6	94 ± 4	96 ± 5	82 ± 2**
Alkaline phosphatase (IU/L)						
Day 3	578 ± 11	580 ± 7	575 ± 9	587 ± 8	622 ± 9**	625 ± 13**
Day 23	385 ± 8	404 ± 9	397 ± 8	382 ± 8	415 ± 9*	434 ± 11**
Week 14	254 ± 4	238 ± 3	233 ± 5*	239 ± 5	241 ± 6	263 ± 5
Creatine kinase (IU/L)						
Day 3	532 ± 64	424 ± 30	426 ± 22 <sup>b</sup>	450 ± 34	629 ± 96	563 ± 35
Day 23	244 ± 16	327 ± 58	330 ± 28*	335 ± 15**	397 ± 42**	378 ± 50**
Week 14	189 ± 22	208 ± 32	237 ± 32	226 ± 25	283 ± 59	261 ± 33
Sorbitol dehydrogenase (IU/L)						
Day 3	13 ± 1 <sup>b</sup>	12 ± 1	13 ± 1	12 ± 1	12 ± 1	16 ± 1
Day 23	14 ± 1	14 ± 1	14 ± 1	13 ± 1	13 ± 1	27 ± 3**
Week 14	26 ± 3	25 ± 1	24 ± 1	23 ± 1	26 ± 1	25 ± 1
Bile acids (μmol/L)						
Day 3	5.8 ± 0.8	4.5 ± 0.5	4.2 ± 0.4	6.7 ± 2.0	6.0 ± 0.8	6.9 ± 1.2
Day 23	4.3 ± 0.5	4.0 ± 0.2	3.7 ± 0.2	4.2 ± 0.4	5.1 ± 1.0	4.2 ± 0.3
Week 14	3.2 ± 0.2	3.0 ± 0.1	2.7 ± 0.1	3.3 ± 0.2	2.7 ± 0.2	2.7 ± 0.1
<b>Female</b>						
Hematology						
n						
Day 3	10	10	10	10	9	10
Day 23	10	10	10	10	10	10
Week 14	10	10	10	10	10	10
Hematocrit (manual) (%)						
Day 3	49.7 ± 0.8	49.4 ± 0.5	48.8 ± 0.4	49.2 ± 0.8	49.3 ± 0.5	50.7 ± 0.4
Day 23	48.9 ± 0.5	48.6 ± 0.3	47.7 ± 0.2	48.7 ± 0.5	48.5 ± 0.2	49.1 ± 0.4
Week 14	48.4 ± 0.4	48.0 ± 0.3	47.3 ± 0.2	47.5 ± 0.2	47.8 ± 0.4	47.6 ± 0.3
Packed cell volume (auto) (%)						
Day 3	48.5 ± 0.8	48.9 ± 0.4	47.8 ± 0.5	48.4 ± 0.8	48.4 ± 0.6	49.5 ± 0.3
Day 23	48.2 ± 0.4	48.3 ± 0.3	47.2 ± 0.3	48.2 ± 0.4	47.7 ± 0.2	48.5 ± 0.5
Week 14	48.0 ± 0.6	47.9 ± 0.3	47.2 ± 0.2	47.3 ± 0.2	47.3 ± 0.6	47.8 ± 0.3
Hemoglobin (g/dL)						
Day 3	15.0 ± 0.2	15.3 ± 0.1	15.1 ± 0.1	15.3 ± 0.2	15.4 ± 0.1	15.7 ± 0.1**
Day 23	15.5 ± 0.1	15.6 ± 0.1	15.3 ± 0.1	15.5 ± 0.1	15.4 ± 0.1	15.7 ± 0.2
Week 14	15.4 ± 0.1	15.4 ± 0.1	15.3 ± 0.1	15.2 ± 0.1	15.2 ± 0.2	15.2 ± 0.1
Erythrocytes (10 <sup>6</sup> /μL)						
Day 3	7.87 ± 0.12	8.03 ± 0.08	7.92 ± 0.08	7.99 ± 0.12	8.08 ± 0.09	8.31 ± 0.07**
Day 23	8.27 ± 0.07	8.26 ± 0.08	8.17 ± 0.08	8.30 ± 0.08	8.16 ± 0.04	8.40 ± 0.10
Week 14	8.46 ± 0.08	8.47 ± 0.06	8.39 ± 0.04	8.41 ± 0.04	8.36 ± 0.10	8.40 ± 0.07

**TABLE F1**  
**Hematology and Clinical Chemistry Data for Rats in the 3-Month Inhalation Study**  
**of Vinylidene Chloride**

	Chamber Control	6.25 ppm	12.5 ppm	25 ppm	50 ppm	100 ppm
<b>Female (continued)</b>						
Hematology (continued)						
n						
Day 3	10	10	10	10	9	10
Day 23	10	10	10	10	10	10
Week 14	10	10	10	10	10	10
Reticulocytes (10 <sup>6</sup> /μL)						
Day 3	0.37 ± 0.04	0.35 ± 0.01 <sup>c</sup>	0.37 ± 0.03	0.36 ± 0.03 <sup>b</sup>	0.36 ± 0.03	0.38 ± 0.02 <sup>b</sup>
Day 23	0.21 ± 0.01	0.24 ± 0.01	0.22 ± 0.01	0.24 ± 0.01	0.25 ± 0.01	0.25 ± 0.01
Week 14	0.17 ± 0.01	0.15 ± 0.01	0.18 ± 0.01	0.16 ± 0.01	0.16 ± 0.01	0.20 ± 0.01
Nucleated erythrocytes/100 leukocytes						
Day 3	0.4 ± 0.2	0.1 ± 0.1	0.2 ± 0.1	0.1 ± 0.1	0.1 ± 0.1	0.1 ± 0.1
Day 23	0.0 ± 0.0	0.1 ± 0.1	0.3 ± 0.2	0.0 ± 0.0	0.0 ± 0.0	0.3 ± 0.2
Week 14	0.4 ± 0.2	0.6 ± 0.2	0.5 ± 0.2	0.7 ± 0.3	0.7 ± 0.3	0.5 ± 0.2
Mean cell volume (fL)						
Day 3	61.6 ± 0.3	60.9 ± 0.4	60.3 ± 0.4	60.7 ± 0.4	60.0 ± 0.5*	59.6 ± 0.4**
Day 23	58.3 ± 0.3	58.5 ± 0.4	57.9 ± 0.3	58.2 ± 0.3	58.5 ± 0.1	57.7 ± 0.2
Week 14	56.7 ± 0.2	56.5 ± 0.2	56.2 ± 0.2	56.2 ± 0.2	56.6 ± 0.2	56.9 ± 0.2
Mean cell hemoglobin (pg)						
Day 3	19.0 ± 0.0	19.0 ± 0.1	19.1 ± 0.1	19.1 ± 0.1	19.1 ± 0.1	19.0 ± 0.1
Day 23	18.8 ± 0.1	18.8 ± 0.1	18.7 ± 0.1	18.7 ± 0.1	18.9 ± 0.1	18.7 ± 0.1
Week 14	18.2 ± 0.1	18.2 ± 0.1	18.3 ± 0.0	18.1 ± 0.1	18.1 ± 0.1	18.1 ± 0.0
Mean cell hemoglobin concentration (g/dL)						
Day 3	30.8 ± 0.1	31.2 ± 0.2	31.7 ± 0.2**	31.5 ± 0.2**	31.9 ± 0.3**	31.8 ± 0.2**
Day 23	32.3 ± 0.2	32.3 ± 0.1	32.4 ± 0.1	32.1 ± 0.1	32.2 ± 0.1	32.3 ± 0.2
Week 14	32.1 ± 0.2	32.1 ± 0.1	32.5 ± 0.1	32.2 ± 0.1	32.0 ± 0.1	31.8 ± 0.1
Platelets (10 <sup>3</sup> /μL)						
Day 3	844.0 ± 22.9	807.7 ± 31.8	831.1 ± 27.3	777.3 ± 14.4	879.0 ± 20.7	799.8 ± 23.6
Day 23	719.0 ± 20.6	709.5 ± 22.2	692.0 ± 19.0	701.0 ± 13.3	706.2 ± 12.5	725.0 ± 11.2
Week 14	630.0 ± 15.5	624.1 ± 13.2	597.4 ± 11.8	626.6 ± 11.9	607.3 ± 9.9	614.9 ± 12.3
Leukocytes (10 <sup>3</sup> /μL)						
Day 3	10.27 ± 0.39	11.19 ± 0.54	12.73 ± 0.31**	13.41 ± 0.46**	13.21 ± 0.49**	12.48 ± 0.34**
Day 23	8.12 ± 0.29	7.16 ± 0.36	8.11 ± 0.61	8.46 ± 0.43	8.17 ± 0.74	8.00 ± 0.59
Week 14	6.69 ± 0.50	5.34 ± 0.25	6.52 ± 0.44	5.90 ± 0.34	6.19 ± 0.52	6.02 ± 0.47
Segmented neutrophils (10 <sup>3</sup> /μL)						
Day 3	0.82 ± 0.06	1.04 ± 0.13	1.85 ± 0.10**	1.20 ± 0.07*	0.94 ± 0.05	0.84 ± 0.04
Day 23	0.85 ± 0.07	0.97 ± 0.11	0.84 ± 0.04	0.79 ± 0.03	0.96 ± 0.14	0.68 ± 0.03
Week 14	1.06 ± 0.09	0.90 ± 0.08	0.95 ± 0.07	0.79 ± 0.05	1.08 ± 0.07	1.09 ± 0.10
Bands (10 <sup>3</sup> /μL)						
Day 3	0.00 ± 0.00	0.00 ± 0.00	0.00 ± 0.00	0.00 ± 0.00	0.00 ± 0.00	0.00 ± 0.00
Day 23	0.00 ± 0.00	0.00 ± 0.00	0.00 ± 0.00	0.00 ± 0.00	0.00 ± 0.00	0.00 ± 0.00
Week 14	0.00 ± 0.00	0.00 ± 0.00	0.00 ± 0.00	0.00 ± 0.00	0.00 ± 0.00	0.00 ± 0.00
Lymphocytes (10 <sup>3</sup> /μL)						
Day 3	9.16 ± 0.39	9.83 ± 0.43	10.62 ± 0.31*	11.76 ± 0.40**	11.80 ± 0.37**	11.34 ± 0.35**
Day 23	7.04 ± 0.25	5.87 ± 0.27	7.03 ± 0.60	7.40 ± 0.45	6.87 ± 0.63	7.04 ± 0.56
Week 14	5.29 ± 0.45	4.21 ± 0.23	5.23 ± 0.48	4.85 ± 0.32	4.77 ± 0.47	4.53 ± 0.37
Monocytes (10 <sup>3</sup> /μL)						
Day 3	0.18 ± 0.05	0.19 ± 0.04	0.13 ± 0.05	0.31 ± 0.10	0.33 ± 0.10	0.17 ± 0.07
Day 23	0.11 ± 0.04	0.22 ± 0.12	0.14 ± 0.07	0.16 ± 0.06	0.23 ± 0.08	0.18 ± 0.06
Week 14	0.25 ± 0.07	0.14 ± 0.05	0.24 ± 0.07	0.16 ± 0.04	0.26 ± 0.06	0.32 ± 0.06

**TABLE F1**  
**Hematology and Clinical Chemistry Data for Rats in the 3-Month Inhalation Study**  
**of Vinylidene Chloride**

	Chamber Control	6.25 ppm	12.5 ppm	25 ppm	50 ppm	100 ppm
<b>Female (continued)</b>						
Hematology (continued)						
n						
Day 3	10	10	10	10	9	10
Day 23	10	10	10	10	10	10
Week 14	10	10	10	10	10	10
Basophils (10 <sup>3</sup> /μL)						
Day 3	0.015 ± 0.002	0.017 ± 0.002	0.012 ± 0.003	0.020 ± 0.004	0.026 ± 0.006	0.021 ± 0.005
Day 23	0.009 ± 0.002	0.006 ± 0.003	0.009 ± 0.004	0.010 ± 0.003	0.007 ± 0.003	0.006 ± 0.002
Week 14	0.005 ± 0.002	0.003 ± 0.002	0.005 ± 0.002	0.007 ± 0.006	0.005 ± 0.002	0.005 ± 0.002
Eosinophils (10 <sup>3</sup> /μL)						
Day 3	0.09 ± 0.01	0.12 ± 0.02	0.12 ± 0.01	0.11 ± 0.01	0.12 ± 0.01	0.11 ± 0.01
Day 23	0.10 ± 0.01	0.10 ± 0.01	0.10 ± 0.01	0.10 ± 0.01	0.10 ± 0.01	0.09 ± 0.02
Week 14	0.09 ± 0.01	0.08 ± 0.01	0.10 ± 0.01	0.09 ± 0.01	0.08 ± 0.01	0.08 ± 0.01
Clinical Chemistry						
n	10	10	10	10	10	10
Urea nitrogen (mg/dL)						
Day 3	10.5 ± 0.5	10.6 ± 0.5	10.4 ± 0.6	10.7 ± 0.5	12.7 ± 0.6*	15.1 ± 0.6**
Day 23	10.9 ± 0.4	12.6 ± 0.7*	12.2 ± 0.5*	12.6 ± 0.5**	13.2 ± 0.5**	14.7 ± 0.6**
Week 14	14.6 ± 0.4	15.1 ± 0.6	15.1 ± 0.5	15.8 ± 0.4	15.9 ± 0.4	15.1 ± 0.4
Creatinine (mg/dL)						
Day 3	0.29 ± 0.01	0.32 ± 0.01	0.30 ± 0.01	0.27 ± 0.02	0.31 ± 0.01	0.30 ± 0.00
Day 23	0.26 ± 0.02	0.28 ± 0.01	0.27 ± 0.02	0.28 ± 0.01	0.29 ± 0.01	0.30 ± 0.00
Week 14	0.39 ± 0.01	0.39 ± 0.01	0.40 ± 0.00	0.43 ± 0.02	0.42 ± 0.02	0.45 ± 0.02**
Glucose (mg/dL)						
Day 3	133 ± 6	152 ± 7	134 ± 6	135 ± 5	128 ± 4	111 ± 3**
Day 23	142 ± 10	107 ± 5**	117 ± 6*	113 ± 5*	112 ± 3*	99 ± 3**
Week 14	124 ± 3	134 ± 8	127 ± 6	132 ± 11	125 ± 4	130 ± 4
Total protein (g/dL)						
Day 3	6.2 ± 0.1	6.0 ± 0.1	6.2 ± 0.1	6.3 ± 0.1	6.3 ± 0.1	6.5 ± 0.1**
Day 23	6.2 ± 0.0	6.4 ± 0.1	6.3 ± 0.0	6.4 ± 0.1	6.5 ± 0.1**	6.6 ± 0.1**
Week 14	7.2 ± 0.1	7.3 ± 0.1	7.5 ± 0.1	7.3 ± 0.1	7.4 ± 0.1	7.4 ± 0.1
Albumin (g/dL)						
Day 3	4.6 ± 0.1	4.4 ± 0.1	4.5 ± 0.0	4.6 ± 0.1	4.6 ± 0.0	4.7 ± 0.0
Day 23	4.6 ± 0.0	4.8 ± 0.0	4.7 ± 0.0	4.8 ± 0.1*	4.9 ± 0.1**	4.9 ± 0.1**
Week 14	5.1 ± 0.1	5.2 ± 0.1	5.3 ± 0.1	5.2 ± 0.0	5.2 ± 0.1	5.1 ± 0.1
Globulin (g/dL)						
Day 3	1.6 ± 0.0	1.6 ± 0.0	1.7 ± 0.0	1.7 ± 0.0*	1.8 ± 0.0*	1.8 ± 0.0**
Day 23	1.6 ± 0.0	1.6 ± 0.0	1.6 ± 0.0	1.6 ± 0.0	1.7 ± 0.1	1.7 ± 0.0
Week 14	2.1 ± 0.0	2.1 ± 0.1	2.2 ± 0.0	2.1 ± 0.0	2.2 ± 0.0	2.3 ± 0.1
A/G ratio (albumin/globulin ratio)						
Day 3	2.8 ± 0.1	2.7 ± 0.0	2.7 ± 0.1	2.6 ± 0.0**	2.6 ± 0.0**	2.6 ± 0.0**
Day 23	2.9 ± 0.0	3.0 ± 0.1	2.9 ± 0.0	3.0 ± 0.0	2.9 ± 0.1	2.8 ± 0.0
Week 14	2.4 ± 0.0	2.5 ± 0.0	2.4 ± 0.0	2.5 ± 0.0	2.4 ± 0.0	2.3 ± 0.0
Alanine aminotransferase (IU/L)						
Day 3	48 ± 1	46 ± 3	43 ± 2	47 ± 1	43 ± 1	63 ± 2
Day 23	38 ± 1	39 ± 1	38 ± 1	37 ± 1	35 ± 1	49 ± 2
Week 14	75 ± 6	65 ± 5	58 ± 5**	51 ± 2**	52 ± 2**	51 ± 2**

**TABLE F1**  
**Hematology and Clinical Chemistry Data for Rats in the 3-Month Inhalation Study**  
**of Vinylidene Chloride**

	Chamber Control	6.25 ppm	12.5 ppm	25 ppm	50 ppm	100 ppm
<b>Female</b> (continued)						
Clinical Chemistry (continued)						
n	10	10	10	10	10	10
Alkaline phosphatase (IU/L)						
Day 3	492 ± 9	467 ± 11	478 ± 5	508 ± 5	511 ± 9	512 ± 10
Day 23	300 ± 4	288 ± 5	293 ± 7	307 ± 7	320 ± 5*	326 ± 6**
Week 14	204 ± 6	192 ± 4	186 ± 7	189 ± 4	200 ± 5	213 ± 4
Creatine kinase (IU/L)						
Day 3	600 ± 77	1,147 ± 334	598 ± 73	509 ± 63	444 ± 42	702 ± 140
Day 23	289 ± 34	291 ± 35	305 ± 15	288 ± 32	267 ± 20	300 ± 36
Week 14	198 ± 13	209 ± 30	212 ± 27	176 ± 27	222 ± 20	254 ± 34
Sorbitol dehydrogenase (IU/L)						
Day 3	11 ± 1	8 ± 1	9 ± 1	12 ± 0	11 ± 1	19 ± 1**
Day 23	12 ± 1	12 ± 1	12 ± 0	12 ± 1	14 ± 0*	20 ± 1**
Week 14	18 ± 1	16 ± 1	15 ± 1	14 ± 0*	15 ± 1	18 ± 1
Bile acids (μmol/L)						
Day 3	5.1 ± 0.6	5.8 ± 0.5	6.9 ± 1.8	4.8 ± 0.3	5.8 ± 0.7	8.2 ± 2.1
Day 23	7.9 ± 1.8	5.7 ± 0.8	7.2 ± 2.2	5.2 ± 0.4	4.2 ± 0.3*	4.6 ± 0.4
Week 14	4.7 ± 0.2	6.2 ± 1.4	4.6 ± 0.2	5.4 ± 1.0	4.3 ± 0.1	4.6 ± 0.7*

\* Significantly different ( $P \leq 0.05$ ) from the chamber control group by Dunn's or Shirley's test

\*\*  $P \leq 0.01$

<sup>a</sup> Data are presented as mean ± standard error. Statistical tests were performed on unrounded data.

<sup>b</sup> n=9

<sup>c</sup> n=8

**TABLE F2**  
**Hematology Data for Mice in the 3-Month Inhalation Study of Vinylidene Chloride<sup>a</sup>**

	Chamber Control	6.25 ppm	12.5 ppm	25 ppm	50 ppm	
<b>Male</b>						
n	10	10	10	10	8	
Hematocrit (manual) (%)	49.9 ± 0.5	48.6 ± 0.3	47.8 ± 0.4**	46.5 ± 0.4**	45.9 ± 0.4**	
Packed cell volume (auto) (%)	50.4 ± 0.4	49.2 ± 0.4	48.1 ± 0.3**	47.2 ± 0.3**	46.9 ± 0.4**	
Hemoglobin (g/dL)	15.5 ± 0.1	15.1 ± 0.1	14.9 ± 0.1**	14.5 ± 0.1**	14.2 ± 0.1**	
Erythrocytes (10 <sup>6</sup> /μL)	10.18 ± 0.09	9.96 ± 0.09	9.74 ± 0.07**	9.54 ± 0.07**	9.40 ± 0.08**	
Reticulocytes (10 <sup>6</sup> /μL)	0.25 ± 0.02	0.24 ± 0.01	0.24 ± 0.02	0.24 ± 0.01	0.24 ± 0.02	
Nucleated erythrocytes/100 leukocytes	0.1 ± 0.1	0.0 ± 0.0	0.0 ± 0.0	0.0 ± 0.0	0.0 ± 0.0	
Howell-Jolly bodies (% erythrocytes)	0.2 ± 0.0	0.2 ± 0.0	0.2 ± 0.0	0.2 ± 0.0	0.1 ± 0.0	
Mean cell volume (fL)	49.5 ± 0.2	49.4 ± 0.2	49.4 ± 0.2	49.5 ± 0.2	49.9 ± 0.2	
Mean cell hemoglobin (pg)	15.3 ± 0.1	15.2 ± 0.1	15.3 ± 0.1	15.2 ± 0.0	15.2 ± 0.0	
Mean cell hemoglobin concentration (g/dL)	30.8 ± 0.2	30.8 ± 0.2	30.9 ± 0.1	30.6 ± 0.1	30.4 ± 0.1	
Platelets (10 <sup>3</sup> /μL)	866.7 ± 15.6	846.8 ± 15.9	898.2 ± 14.8	970.3 ± 10.7**	993.4 ± 11.8**	
Leukocytes (10 <sup>3</sup> /μL)	2.52 ± 0.27	2.45 ± 0.32	2.48 ± 0.28	2.24 ± 0.28	2.56 ± 0.43	
Segmented neutrophils (10 <sup>3</sup> /μL)	0.31 ± 0.03	0.26 ± 0.03	0.31 ± 0.06	0.28 ± 0.03	0.28 ± 0.04	
Bands (10 <sup>3</sup> /μL)	0.00 ± 0.00	0.00 ± 0.00	0.00 ± 0.00	0.00 ± 0.00	0.00 ± 0.00	
Lymphocytes (10 <sup>3</sup> /μL)	2.13 ± 0.24	2.07 ± 0.29	2.06 ± 0.25	1.87 ± 0.25	2.18 ± 0.40	
Monocytes (10 <sup>3</sup> /μL)	0.02 ± 0.01	0.05 ± 0.01	0.06 ± 0.02	0.04 ± 0.01	0.04 ± 0.02	
Basophils (10 <sup>3</sup> /μL)	0.009 ± 0.002	0.012 ± 0.002	0.011 ± 0.002	0.012 ± 0.003	0.014 ± 0.003	
Eosinophils (10 <sup>3</sup> /μL)	0.04 ± 0.01	0.05 ± 0.01	0.03 ± 0.00	0.04 ± 0.01	0.04 ± 0.01	
	Chamber Control	6.25 ppm	12.5 ppm	25 ppm	50 ppm	100 ppm
<b>Female</b>						
n	10	9	10	10	10	6
Hematocrit (manual) (%)	50.2 ± 0.4	49.8 ± 0.4	49.8 ± 0.3	49.3 ± 0.4	48.3 ± 0.5**	50.3 ± 0.4
Packed cell volume (auto) (%)	50.7 ± 0.4	50.2 ± 0.3	50.4 ± 0.4	49.9 ± 0.4	48.7 ± 0.5*	50.5 ± 0.4
Hemoglobin (g/dL)	15.9 ± 0.1	15.7 ± 0.1	15.7 ± 0.1	15.6 ± 0.2	15.3 ± 0.1*	15.7 ± 0.1
Erythrocytes (10 <sup>6</sup> /μL)	10.19 ± 0.09	10.08 ± 0.06	10.02 ± 0.07	9.97 ± 0.11	9.73 ± 0.09**	9.80 ± 0.08**
Reticulocytes (10 <sup>6</sup> /μL)	0.21 ± 0.01	0.20 ± 0.02	0.20 ± 0.01	0.19 ± 0.01	0.20 ± 0.02	0.16 ± 0.02
Nucleated erythrocytes/100 leukocytes	0.0 ± 0.0	0.0 ± 0.0	0.0 ± 0.0	0.0 ± 0.0	0.0 ± 0.0	0.0 ± 0.0
Howell-Jolly bodies (% erythrocytes)	0.2 ± 0.0	0.2 ± 0.0	0.1 ± 0.0	0.2 ± 0.0	0.1 ± 0.0	0.2 ± 0.0
Mean cell volume (fL)	49.8 ± 0.2	49.8 ± 0.1	50.3 ± 0.2	50.1 ± 0.3	50.0 ± 0.1	51.5 ± 0.2**
Mean cell hemoglobin (pg)	15.6 ± 0.1	15.6 ± 0.1	15.7 ± 0.0	15.7 ± 0.1	15.7 ± 0.0	16.0 ± 0.0**
Mean cell hemoglobin concentration (g/dL)	31.3 ± 0.1	31.3 ± 0.1	31.2 ± 0.1	31.3 ± 0.1	31.4 ± 0.1	31.2 ± 0.1
Platelets (10 <sup>3</sup> /μL)	751.2 ± 11.4	789.1 ± 17.1	801.8 ± 13.3*	833.2 ± 13.4**	853.0 ± 14.9**	864.3 ± 28.3**
Leukocytes (10 <sup>3</sup> /μL)	2.90 ± 0.25	2.67 ± 0.11	2.48 ± 0.19	3.22 ± 0.39	3.19 ± 0.28	3.61 ± 0.40
Segmented neutrophils (10 <sup>3</sup> /μL)	0.37 ± 0.03	0.31 ± 0.03	0.26 ± 0.03	0.33 ± 0.06	0.41 ± 0.07	0.30 ± 0.04
Bands (10 <sup>3</sup> /μL)	0.00 ± 0.00	0.00 ± 0.00	0.00 ± 0.00	0.00 ± 0.00	0.00 ± 0.00	0.00 ± 0.00
Lymphocytes (10 <sup>3</sup> /μL)	2.45 ± 0.22	2.26 ± 0.09	2.14 ± 0.16	2.78 ± 0.33	2.67 ± 0.27	3.20 ± 0.38
Monocytes (10 <sup>3</sup> /μL)	0.04 ± 0.01	0.06 ± 0.02	0.05 ± 0.01	0.07 ± 0.01	0.05 ± 0.01	0.06 ± 0.01
Basophils (10 <sup>3</sup> /μL)	0.013 ± 0.002	0.022 ± 0.004	0.012 ± 0.002	0.019 ± 0.004	0.019 ± 0.003	0.020 ± 0.005
Eosinophils (10 <sup>3</sup> /μL)	0.03 ± 0.01	0.03 ± 0.01	0.02 ± 0.01	0.03 ± 0.01	0.04 ± 0.01	0.03 ± 0.01

\* Significantly different (P ≤ 0.05) from the chamber control group by Dunn's or Shirley's test

\*\* P ≤ 0.01

<sup>a</sup> Data are presented as mean ± standard error. Statistical tests were performed on unrounded data.

## **APPENDIX G ORGAN WEIGHTS AND ORGAN-WEIGHT-TO-BODY-WEIGHT RATIOS**

<b>TABLE G1</b>	<b>Organ Weights and Organ-Weight-to-Body-Weight Ratios for Rats in the 2-Week Inhalation Study of Vinylidene Chloride .....</b>	<b>G-2</b>
<b>TABLE G2</b>	<b>Organ Weights and Organ-Weight-to-Body-Weight Ratios for Rats in the 3-Month Inhalation Study of Vinylidene Chloride .....</b>	<b>G-3</b>
<b>TABLE G3</b>	<b>Organ Weights and Organ-Weight-to-Body-Weight Ratios for Mice in the 2-Week Inhalation Study of Vinylidene Chloride .....</b>	<b>G-4</b>
<b>TABLE G4</b>	<b>Organ Weights and Organ-Weight-to-Body-Weight Ratios for Mice at the 3-Month Inhalation Study of Vinylidene Chloride .....</b>	<b>G-5</b>

**TABLE G1**  
**Organ Weights and Organ-Weight-to-Body-Weight Ratios for Rats in the 2-Week Inhalation Study**  
**of Vinylidene Chloride<sup>a</sup>**

	Chamber Control	25 ppm	50 ppm	100 ppm	200 ppm	400 ppm
<b>Male</b>						
n	5	4	5	5	0	0
Necropsy body wt	158 ± 2	150 ± 3	159 ± 5	154 ± 2		
Heart						
Absolute	0.57 ± 0.01	0.55 ± 0.02	0.57 ± 0.02	0.56 ± 0.01		
Relative	3.590 ± 0.042	3.640 ± 0.079	3.559 ± 0.046	3.655 ± 0.043		
R. Kidney						
Absolute	0.61 ± 0.01	0.70 ± 0.01**	0.71 ± 0.02**	0.71 ± 0.02**		
Relative	3.878 ± 0.045	4.641 ± 0.054**	4.460 ± 0.124**	4.625 ± 0.074**		
Liver						
Absolute	7.06 ± 0.18	6.50 ± 0.16	6.84 ± 0.21	6.79 ± 0.13		
Relative	44.561 ± 0.628	43.247 ± 0.147	43.045 ± 0.419	44.042 ± 0.578		
Lung						
Absolute	1.04 ± 0.02	1.14 ± 0.05	1.11 ± 0.07	1.20 ± 0.06		
Relative	6.557 ± 0.110	7.548 ± 0.248	6.991 ± 0.263	7.776 ± 0.372*		
R. Testis						
Absolute	0.904 ± 0.020	0.922 ± 0.029	0.965 ± 0.037	0.918 ± 0.022		
Relative	5.712 ± 0.123	6.128 ± 0.077	6.065 ± 0.128	5.954 ± 0.115		
Thymus						
Absolute	0.401 ± 0.020	0.389 ± 0.021	0.417 ± 0.024	0.374 ± 0.011		
Relative	2.533 ± 0.104	2.584 ± 0.103	2.622 ± 0.119	2.428 ± 0.080		
<b>Female</b>						
n	5	5	5	5	0	0
Necropsy body wt	124 ± 2	125 ± 3	122 ± 1	117 ± 3		
Heart						
Absolute	0.45 ± 0.01	0.46 ± 0.01	0.47 ± 0.00	0.46 ± 0.01		
Relative	3.633 ± 0.044	3.680 ± 0.059	3.874 ± 0.045**	3.924 ± 0.068**		
R. Kidney						
Absolute	0.53 ± 0.01	0.61 ± 0.01**	0.59 ± 0.01*	0.59 ± 0.02**		
Relative	4.299 ± 0.068	4.904 ± 0.083**	4.826 ± 0.079**	5.084 ± 0.079**		
Liver						
Absolute	5.07 ± 0.13	4.96 ± 0.12	4.86 ± 0.08	4.87 ± 0.14		
Relative	40.971 ± 0.433	39.867 ± 0.386	39.860 ± 0.846	41.676 ± 0.349		
Lung						
Absolute	0.88 ± 0.04	0.95 ± 0.05	0.95 ± 0.09	0.87 ± 0.04		
Relative	7.066 ± 0.214	7.643 ± 0.350	7.844 ± 0.747	7.414 ± 0.277		
Thymus						
Absolute	0.330 ± 0.012	0.373 ± 0.014	0.353 ± 0.013	0.328 ± 0.013		
Relative	2.667 ± 0.082	2.988 ± 0.046*	2.900 ± 0.120	2.807 ± 0.052		

\* Significantly different (P≤0.05) from the chamber control group by Williams' or Dunnett's test

\*\* P≤0.01

<sup>a</sup> Organ weights (absolute weights) and body weights are given in grams; organ-weight-to-body-weight ratios (relative weights) are given as mg organ weight/g body weight (mean ± standard error). No data available for 200 ppm and 400 ppm males and females due to 100% mortality.

**TABLE G2**  
**Organ Weights and Organ-Weight-to-Body-Weight Ratios for Rats in the 3-Month Inhalation Study of Vinylidene Chloride<sup>a</sup>**

	Chamber Control	6.25 ppm	12.5 ppm	25 ppm	50 ppm	100 ppm
n	10	10	10	10	10	10
<b>Male</b>						
Necropsy body wt	326 ± 7	332 ± 6	337 ± 5	319 ± 6	340 ± 6	322 ± 5
Heart						
Absolute	0.89 ± 0.02	0.93 ± 0.02	0.88 ± 0.02	0.86 ± 0.02	0.92 ± 0.02	0.89 ± 0.03
Relative	2.713 ± 0.022	2.807 ± 0.068	2.628 ± 0.031	2.700 ± 0.023	2.694 ± 0.033	2.757 ± 0.055
R. Kidney						
Absolute	0.99 ± 0.02	1.07 ± 0.04	1.05 ± 0.03	1.01 ± 0.03	1.08 ± 0.02	1.05 ± 0.02
Relative	3.026 ± 0.028	3.208 ± 0.091*	3.129 ± 0.035*	3.171 ± 0.039	3.167 ± 0.029	3.245 ± 0.038**
Liver						
Absolute	10.63 ± 0.32	10.61 ± 0.26	10.46 ± 0.27	9.77 ± 0.27	10.59 ± 0.32	10.23 ± 0.28
Relative	32.562 ± 0.400	31.951 ± 0.510	31.034 ± 0.404	30.596 ± 0.376**	31.062 ± 0.456	31.697 ± 0.412
Lung						
Absolute	1.66 ± 0.06	1.59 ± 0.06	1.60 ± 0.04	1.59 ± 0.06	1.71 ± 0.09	1.50 ± 0.05
Relative	5.075 ± 0.148	4.781 ± 0.132	4.766 ± 0.115	4.986 ± 0.128	5.003 ± 0.194	4.665 ± 0.129
R. Testis						
Absolute	1.343 ± 0.026	1.353 ± 0.019	1.346 ± 0.022	1.316 ± 0.020	1.346 ± 0.017	1.314 ± 0.021
Relative	4.122 ± 0.056	4.082 ± 0.073	4.004 ± 0.061	4.135 ± 0.083	3.963 ± 0.068	4.085 ± 0.077
Thymus						
Absolute	0.335 ± 0.014	0.358 ± 0.011	0.326 ± 0.012	0.314 ± 0.015	0.344 ± 0.13	0.328 ± 0.017
Relative	1.025 ± 0.032	1.080 ± 0.033	0.969 ± 0.036	0.985 ± 0.047	1.014 ± 0.038	1.018 ± 0.052
<b>Female</b>						
Necropsy body wt	203 ± 3	205 ± 6	206 ± 4	201 ± 4	205 ± 4	195 ± 2
Heart						
Absolute	0.61 ± 0.01	0.60 ± 0.01	0.61 ± 0.01	0.61 ± 0.02	0.63 ± 0.02	0.60 ± 0.01
Relative	2.978 ± 0.055	2.926 ± 0.039	2.980 ± 0.038	3.017 ± 0.048	3.077 ± 0.044	3.046 ± 0.042
R. Kidney						
Absolute	0.64 ± 0.01	0.67 ± 0.02	0.69 ± 0.02*	0.68 ± 0.01*	0.72 ± 0.01**	0.71 ± 0.02**
Relative	3.155 ± 0.041	3.280 ± 0.055	3.356 ± 0.043**	3.393 ± 0.040**	3.512 ± 0.025**	3.645 ± 0.058**
Liver						
Absolute	5.84 ± 0.10	5.72 ± 0.24	5.87 ± 0.18	5.51 ± 0.14	5.97 ± 0.16	5.94 ± 0.16
Relative	28.741 ± 0.345	27.921 ± 0.470	28.538 ± 0.588	27.452 ± 0.505	29.175 ± 0.598	30.393 ± 0.495
Lung						
Absolute	1.08 ± 0.02	1.11 ± 0.03	1.10 ± 0.02	1.09 ± 0.03	1.12 ± 0.05	1.07 ± 0.02
Relative	5.303 ± 0.080	5.415 ± 0.100	5.338 ± 0.128	5.429 ± 0.125	5.451 ± 0.248	5.454 ± 0.070
Thymus						
Absolute	0.279 ± 0.010	0.265 ± 0.013	0.268 ± 0.011	0.255 ± 0.008	0.274 ± 0.009	0.266 ± 0.008
Relative	1.372 ± 0.040	1.303 ± 0.069	1.301 ± 0.048	1.270 ± 0.032	1.342 ± 0.046	1.359 ± 0.037

\* Significantly different (P<0.05) from the chamber control group by Williams' or Dunnett's test

\*\* P<0.01

<sup>a</sup> Organ weights (absolute weights) and body weights are given in grams; organ-weight-to-body-weight ratios (relative weights) are given as mg organ weight/g body weight (mean ± standard error).



**TABLE G3**  
**Organ Weights and Organ-Weight-to-Body-Weight Ratios for Mice in the 2-Week Inhalation Study**  
**of Vinylidene Chloride<sup>a</sup>**

	Chamber Control	25 ppm	50 ppm	100 ppm	200 ppm	400 ppm
<b>Male</b>						
n	5	4	5	5	0	0
Necropsy body wt	26.6 ± 0.9	24.4 ± 0.9	24.9 ± 0.2			
Heart						
Absolute	0.13 ± 0.01	0.12 ± 0.01	0.12 ± 0.00			
Relative	4.952 ± 0.129	4.826 ± 0.059	4.728 ± 0.087			
R. Kidney						
Absolute	0.22 ± 0.02	0.23 ± 0.01	0.22 ± 0.01			
Relative	8.309 ± 0.292	9.495 ± 0.137**	8.851 ± 0.301			
Liver						
Absolute	1.42 ± 0.07	1.48 ± 0.07	1.56 ± 0.03			
Relative	53.190 ± 0.796	60.483 ± 1.044**	62.658 ± 0.713**			
Lung						
Absolute	0.18 ± 0.01	0.19 ± 0.01	0.19 ± 0.01			
Relative	6.663 ± 0.215	7.682 ± 0.279*	7.751 ± 0.237*			
R. Testis						
Absolute	0.100 ± 0.004	0.102 ± 0.003	0.095 ± 0.002			
Relative	3.749 ± 0.068	4.188 ± 0.107*	3.816 ± 0.113			
Thymus						
Absolute	0.049 ± 0.003	0.055 ± 0.005	0.053 ± 0.004			
Relative	1.845 ± 0.046	2.222 ± 0.156	2.113 ± 0.173			
<b>Female</b>						
n	5	5	5	4	0	0
Necropsy body wt	22.2 ± 0.4	21.8 ± 0.5	21.4 ± 0.3	22.2 ± 0.7		
Heart						
Absolute	0.12 ± 0.00	0.12 ± 0.01	0.11 ± 0.00	0.10 ± 0.00*		
Relative	5.321 ± 0.125	5.580 ± 0.138	5.133 ± 0.111	4.633 ± 0.071**		
R. Kidney						
Absolute	0.16 ± 0.01	0.18 ± 0.01*	0.17 ± 0.00	0.16 ± 0.01		
Relative	7.026 ± 0.241	8.340 ± 0.212**	8.029 ± 0.134**	7.224 ± 0.204		
Liver						
Absolute	1.14 ± 0.03	1.23 ± 0.04	1.30 ± 0.01*	1.43 ± 0.07**		
Relative	51.248 ± 0.827	56.253 ± 0.396**	60.528 ± 0.792**	64.395 ± 1.497**		
Lung						
Absolute	0.15 ± 0.01	0.21 ± 0.01**	0.19 ± 0.01*	0.21 ± 0.02**		
Relative	6.932 ± 0.514	9.460 ± 0.297**	9.055 ± 0.315**	9.567 ± 0.456**		
Thymus						
Absolute	0.066 ± 0.003	0.074 ± 0.005	0.069 ± 0.002	0.059 ± 0.006		
Relative	2.976 ± 0.105	3.375 ± 0.160	3.228 ± 0.075	2.649 ± 0.239		

\* Significantly different ( $P \leq 0.05$ ) from the chamber control group by Williams' or Dunnett's test

\*\*  $P \leq 0.01$

<sup>a</sup> Organ weights (absolute weights) and body weights are given in grams; organ-weight-to-body-weight ratios (relative weights) are given as mg organ weight/g body weight (mean ± standard error). No data available for 100 ppm males and 200 ppm and 400 ppm males and females due to 100% mortality.

**TABLE G4**  
**Organ Weights and Organ-Weight-to-Body-Weight Ratios for Mice in the 3-Month Inhalation Study**  
**of Vinylidene Chloride<sup>a</sup>**

	Chamber Control	6.25 ppm	12.5 ppm	25 ppm	50 ppm	
<b>Male</b>						
n	10	10	10	10	8	
Necropsy body wt	39.4 ± 1.2	37.8 ± 0.5	35.5 ± 0.6**	33.5 ± 0.8**	33.0 ± 0.5**	
Heart						
Absolute	0.16 ± 0.01	0.15 ± 0.00	0.15 ± 0.01	0.15 ± 0.00	0.15 ± 0.01	
Relative	4.090 ± 0.083	3.950 ± 0.061	4.171 ± 0.104	4.516 ± 0.084**	4.548 ± 0.121**	
R. Kidney						
Absolute	0.32 ± 0.01	0.28 ± 0.01**	0.26 ± 0.01**	0.25 ± 0.01**	0.25 ± 0.01**	
Relative	8.073 ± 0.180	7.390 ± 0.120*	7.217 ± 0.199**	7.607 ± 0.162	7.421 ± 0.234	
Liver						
Absolute	1.60 ± 0.05	1.52 ± 0.03	1.62 ± 0.04	1.65 ± 0.05	1.72 ± 0.08	
Relative	40.528 ± 0.231	40.138 ± 0.502	45.631 ± 0.986**	49.264 ± 0.948**	51.978 ± 1.596**	
Lung						
Absolute	0.21 ± 0.01	0.20 ± 0.01	0.21 ± 0.01	0.21 ± 0.01	0.21 ± 0.01	
Relative	5.271 ± 0.135	5.248 ± 0.123	5.878 ± 0.162*	6.379 ± 0.194**	6.390 ± 0.262**	
R. Testis						
Absolute	0.113 ± 0.002	0.115 ± 0.002	0.111 ± 0.003	0.116 ± 0.002	0.110 ± 0.003	
Relative	2.887 ± 0.072	3.033 ± 0.041	3.138 ± 0.067*	3.471 ± 0.090**	3.335 ± 0.102**	
Thymus						
Absolute	0.050 ± 0.003	0.053 ± 0.002	0.047 ± 0.002	0.055 ± 0.002	0.052 ± 0.002	
Relative	1.258 ± 0.073	1.395 ± 0.060	1.338 ± 0.045	1.638 ± 0.052**	1.575 ± 0.050**	
	Chamber Control	6.25 ppm	12.5 ppm	25 ppm	50 ppm	100 ppm
<b>Female</b>						
n	10	10	10	10	10	6
Necropsy body wt	35.2 ± 1.2	30.8 ± 0.6**	31.9 ± 0.9**	30.9 ± 0.8**	28.7 ± 0.6**	29.9 ± 0.8**
Heart						
Absolute	0.15 ± 0.00	0.14 ± 0.00	0.15 ± 0.00	0.15 ± 0.00	0.15 ± 0.01	0.16 ± 0.00
Relative	4.176 ± 0.113	4.589 ± 0.127**	4.630 ± 0.087**	4.985 ± 0.061**	5.123 ± 0.147**	5.297 ± 0.096**
R. Kidney						
Absolute	0.21 ± 0.01	0.21 ± 0.00	0.22 ± 0.01	0.23 ± 0.00	0.22 ± 0.00	0.24 ± 0.01**
Relative	6.119 ± 0.175	6.791 ± 0.125**	6.990 ± 0.149**	7.308 ± 0.167**	7.680 ± 0.161**	8.114 ± 0.219**
Liver						
Absolute	1.43 ± 0.03	1.41 ± 0.03	1.55 ± 0.04*	1.77 ± 0.04**	1.63 ± 0.05**	1.87 ± 0.08**
Relative	40.788 ± 0.973	45.680 ± 0.880**	48.769 ± 0.632**	57.129 ± 0.447**	56.632 ± 0.571**	62.493 ± 1.149**
Lung						
Absolute	0.24 ± 0.01	0.22 ± 0.01	0.25 ± 0.01	0.23 ± 0.01	0.25 ± 0.02	0.29 ± 0.01**
Relative	6.755 ± 0.325	7.009 ± 0.165	7.841 ± 0.333*	7.602 ± 0.291*	8.613 ± 0.493**	9.631 ± 0.261**
Thymus						
Absolute	0.058 ± 0.003	0.057 ± 0.003	0.057 ± 0.002	0.067 ± 0.005	0.063 ± 0.002	0.060 ± 0.005
Relative	1.653 ± 0.091	1.835 ± 0.086	1.795 ± 0.080	2.162 ± 0.146**	2.191 ± 0.044**	2.003 ± 0.144**

\* Significantly different (P<0.05) from the chamber control group by Williams' or Dunnett's test

\*\* P<0.01

<sup>a</sup> Organ weights (absolute weights) and body weights are given in grams; organ-weight-to-body-weight ratios (relative weights) are given as mg organ weight/g body weight (mean ± standard error).



## **APPENDIX H**

# **REPRODUCTIVE TISSUE EVALUATIONS AND ESTROUS CYCLE CHARACTERIZATION**

<b>TABLE H1</b>	<b>Summary of Reproductive Tissue Evaluations for Male Rats in the 3-Month Inhalation Study of Vinylidene Chloride .....</b>	<b>H-2</b>
<b>TABLE H2</b>	<b>Estrous Cycle Characterization for Female Rats in the 3-Month Inhalation Study of Vinylidene Chloride .....</b>	<b>H-2</b>
<b>TABLE H3</b>	<b>Summary of Reproductive Tissue Evaluations for Male Mice in the 3-Month Inhalation Study of Vinylidene Chloride .....</b>	<b>H-3</b>
<b>TABLE H4</b>	<b>Estrous Cycle Characterization for Female Mice in the 3-Month Inhalation Study of Vinylidene Chloride .....</b>	<b>H-3</b>

**TABLE H1**  
**Summary of Reproductive Tissue Evaluations for Male Rats in the 3-Month Inhalation Study of Vinylidene Chloride<sup>a</sup>**

	Chamber Control	25 ppm	50 ppm	100 ppm
n	10	10	10	10
Weights (g)				
Necropsy body wt	326 ± 7	319 ± 6	340 ± 6	322 ± 5
L. Cauda epididymis	0.1745 ± 0.0043	0.1724 ± 0.0059	0.1703 ± 0.0049	0.1642 ± 0.0103
L. Epididymis	0.5200 ± 0.0162	0.5138 ± 0.0158	0.4903 ± 0.0092	0.4932 ± 0.0165
L. Testis	1.4096 ± 0.0229	1.3879 ± 0.0235	1.3749 ± 0.0301	1.3718 ± 0.0246
Spermatid measurements				
Spermatid heads (10 <sup>6</sup> /testis)	188.4 ± 8.4	169.3 ± 8.2	177.8 ± 7.6	158.5 ± 5.2*
Spermatid heads (10 <sup>6</sup> /g testis)	150.3 ± 4.9	136.5 ± 6.6	148.4 ± 5.1	128.4 ± 3.9*
Epididymal spermatozoal measurements				
Sperm motility (%)	87.13 ± 1.13	84.90 ± 1.20	84.55 ± 0.90	82.55 ± 1.07**
Sperm (10 <sup>6</sup> /cauda epididymis)	106.4 ± 6.6	107.8 ± 5.8	107.5 ± 6.8	102.8 ± 6.4
Sperm (10 <sup>6</sup> /g cauda epididymis)	610 ± 37	632 ± 41	629 ± 33	655 ± 67

\* Significantly different (P<0.05) from the chamber control group by Dunn's test

\*\* Significantly different (P<0.01) from the chamber control group by Shirley's test

<sup>a</sup> Data are presented as mean ± standard error. Differences from the chamber control group are not significant by Dunnett's test (body and tissue weights) or Dunn's test (sperm per cauda epididymis and per g cauda epididymis).

**TABLE H2**  
**Estrous Cycle Characterization for Female Rats in the 3-Month Inhalation Study of Vinylidene Chloride<sup>a</sup>**

	Chamber Control	25 ppm	50 ppm	100 ppm
Number weighed at necropsy	10	10	10	10
Necropsy body wt (g)	203 ± 3	201 ± 4	205 ± 4	195 ± 2
Proportion of regular cycling females <sup>b</sup>	10/10	10/10	10/10	10/10
Estrous cycle length (days)	4.95 ± 0.05	4.85 ± 0.11	5.00 ± 0.00	5.10 ± 0.10
Estrous stages (% of cycle)				
Diestrus	49.2	45.0	50.8	48.3
Proestrus	17.5	19.2	20.8	17.5
Estrus	20.0	18.3	20.0	20.8
Metestrus	13.3	16.7	8.3	13.3
Uncertain diagnoses	0.0	0.8	0.0	0.0

<sup>a</sup> Necropsy body weights and estrous cycle length data are presented as mean ± standard error. Differences from the chamber control group are not significant by Dunnett's test (body weight) or Dunn's test (estrous cycle length). By multivariate analysis of variance, exposed females do not differ significantly from the chamber control females in the relative length of time spent in the estrous stages. Tests for equality of transition probability matrices among all groups and between the chamber control group and each exposed group indicated exposed females did not have significantly more extended estrus or diestrus than the chamber control group.

<sup>b</sup> Number of females with a regular cycle/number of females cycling

**TABLE H3**  
**Summary of Reproductive Tissue Evaluations for Male Mice in the 3-Month Inhalation Study of Vinylidene Chloride<sup>a</sup>**

	Chamber Control	12.5 ppm	25 ppm	50 ppm
n	10	10	10	8
Weights (g)				
Necropsy body wt	39.4 ± 1.2	35.5 ± 0.6**	33.5 ± 0.8**	33.0 ± 0.5**
L. Cauda epididymis	0.0221 ± 0.0011	0.0217 ± 0.0011	0.0182 ± 0.0010	0.0200 ± 0.0019
L. Epididymis	0.0604 ± 0.0020	0.0646 ± 0.0032	0.0563 ± 0.0029	0.0567 ± 0.0020
L. Testis	0.1096 ± 0.0027	0.1119 ± 0.0020	0.1092 ± 0.0021	0.1090 ± 0.0029
Spermatid measurements				
Spermatid heads (10 <sup>6</sup> /testis)	21.24 ± 1.45	21.63 ± 0.95	21.38 ± 1.08	20.74 ± 0.68
Spermatid heads (10 <sup>6</sup> /g testis)	242.7 ± 13.9	230.5 ± 7.5	231.8 ± 4.2	240.8 ± 9.0
Epididymal spermatozoal measurements				
Sperm motility (%)	82.7 ± 1.4	84.6 ± 0.9	84.8 ± 1.4	79.8 ± 2.0
Sperm (10 <sup>6</sup> /cauda epididymis)	21.4 ± 1.3	17.3 ± 0.5**	15.7 ± 0.4**	14.9 ± 0.6**
Sperm (10 <sup>6</sup> /g cauda epididymis)	751 ± 44	631 ± 35	736 ± 61	609 ± 75

\*\* Significantly different (P≤0.01) from the chamber control group by Williams' test (body weights) or by Shirley's test (sperm per cauda epididymis)

<sup>a</sup> Data are presented as mean ± standard error. Differences from the chamber control group are not significant by Dunnett's test (tissue weights) or Dunn's test (spermatid measurements, sperm motility, and sperm per g cauda epididymis).

**TABLE H4**  
**Estrous Cycle Characterization for Female Mice in the 3-Month Inhalation Study of Vinylidene Chloride<sup>a</sup>**

	Chamber Control	12.5 ppm	25 ppm	50 ppm
Number weighed at necropsy	10	10	10	10
Necropsy body wt (g)	35.2 ± 1.2	31.9 ± 0.9*	30.9 ± 0.8**	28.7 ± 0.6**
Proportion of regular cycling females <sup>b</sup>	9/10	9/9	10/10	9/10
Estrous cycle length (days)	4.09 ± 0.12	3.98 ± 0.14 <sup>c</sup>	3.88 ± 0.05	4.10 ± 0.10
Estrous stages (% of cycle)				
Diestrus	25.8	25.8	25.0	25.0
Proestrus	1.7	0.0	0.8	0.8
Estrus	48.3	48.3	48.3	50.0
Metestrus	24.2	25.0	25.0	24.2
Uncertain diagnoses	0.0	0.8	0.8	0.0

\* Significantly different (P≤0.05) from the chamber control group by Williams' test

\*\* (P≤0.01)

<sup>a</sup> Necropsy body weights and estrous cycle length data are presented as mean ± standard error. Differences from the chamber control group are not significant by Dunn's test (estrous cycle length). By multivariate analysis of variance, exposed females do not differ significantly from the chamber control females in the relative length of time spent in the estrous stages. Tests for equality of transition probability matrices among all groups and between the chamber control group and each exposed group indicated exposed females did not have significantly more extended estrus or diestrus than the chamber control group.

<sup>b</sup> Number of females with a regular cycle/number of females cycling

<sup>c</sup> Estrous cycle was longer than 12 days or unclear in 1 of 10 animals



# APPENDIX I

## CHEMICAL CHARACTERIZATION AND GENERATION OF CHAMBER CONCENTRATIONS

<b>PROCUREMENT AND CHARACTERIZATION OF VINYLIDENE CHLORIDE .....</b>	<b>I-2</b>
<b>VAPOR GENERATION AND EXPOSURE SYSTEM .....</b>	<b>I-2</b>
<b>VAPOR CONCENTRATION MONITORING.....</b>	<b>I-3</b>
<b>CHAMBER ATMOSPHERE CHARACTERIZATION .....</b>	<b>I-3</b>
<b>FIGURE I1 Infrared Absorption Spectrum of Vinylidene Chloride .....</b>	<b>I-5</b>
<b>FIGURE I2 Proton Nuclear Magnetic Resonance Spectrum of Vinylidene Chloride .....</b>	<b>I-6</b>
<b>TABLE I1 Gas Chromatography Systems Used in the Inhalation Studies of Vinylidene Chloride .....</b>	<b>I-7</b>
<b>FIGURE I3 Schematic of the Vapor Generation and Delivery System in the Inhalation Studies of Vinylidene Chloride .....</b>	<b>I-8</b>
<b>TABLE I2 Summary of Chamber Concentrations in the 2-Week Inhalation Studies of Vinylidene Chloride .....</b>	<b>I-9</b>
<b>TABLE I3 Summary of Chamber Concentrations in the 3-Month Inhalation Studies of Vinylidene Chloride .....</b>	<b>I-9</b>
<b>TABLE I4 Summary of Chamber Concentrations in the 2-Year Inhalation Studies of Vinylidene Chloride .....</b>	<b>I-10</b>



# CHEMICAL CHARACTERIZATION AND GENERATION OF CHAMBER CONCENTRATIONS

## PROCUREMENT AND CHARACTERIZATION OF VINYLIDENE CHLORIDE

Vinylidene chloride, manufactured by Dow Chemical Company (Freeport, TX), was obtained in one lot from Sigma-Aldrich and was used in the 2-week, 3-month, and 2-year studies. The material was identified as lot SB20019301. Identity and purity analyses were conducted by the analytical chemistry laboratory at Chemir Pharma Services (Maryland Heights, MO) and the study laboratory at Battelle Toxicology Northwest (Richland, WA). Reports on analyses performed in support of the vinylidene chloride studies are on file at the National Institute of Environmental Health Sciences.

Lot SB20019301, a colorless, low viscosity liquid with a sweet odor, was identified as vinylidene chloride by the analytical chemistry laboratory using Fourier transform infrared (IR) and proton nuclear magnetic resonance (NMR) spectroscopy. All spectra were consistent with the literature spectra (Aldrich, 1993, 1997) and the structure of vinylidene chloride. Representative IR and proton NMR spectra are presented in Figures I1 and I2, respectively.

For lot SB20019301, the analytical chemistry laboratory determined the water content using Karl Fischer titration, conducted elemental analyses to determine the carbon and hydrogen content, and determined residual chloride content after extraction for free chloride using anion exchange chromatography by a system that included a Dionex DX-100 ion chromatograph (Dionex Corporation, Bannockburn, IL). Additional testing was performed on the bulk chemical by the study laboratory that included titration with potassium iodide (KI) to determine the amount of peroxide present; a turbidity assay to determine the polymer content using a Beckman DU-650 spectrophotometer (Beckman Coulter, Inc., Fullerton, CA) with ultraviolet detection at 420 nm; and gas chromatography (GC) with flame ionization detection (FID) by one system to measure the concentration of the stabilizer of monomethyl ether of hydroquinone (MEHQ) and by a second system to determine area percent purity.

For lot SB20019301, Karl Fischer titration indicated a water content of 74 ppm. Elemental analyses for carbon and hydrogen were consistent with theoretical values. KI titration indicated that peroxide was less than 1 ppm by weight as active oxygen compared to vinylidene chloride. Anion exchange chromatography indicated that residual chloride content was less than 2 ppm. A turbidity assay showed that the concentration of polymer was less than 9 ppm. GC/FID by system A (Table II) indicated that the test article was stabilized with approximately 300 ppm MEHQ. GC/FID by system B indicated an area percent purity greater than 99.9%. The overall purity of lot SB20019301 was determined to be greater than 99.9%.

To ensure stability, the bulk chemical was stored under a nitrogen headspace in the original shipping containers (400-L steel mini-Bulk™ containers) at a temperature of approximately 63° F. Periodic reanalyses of the bulk chemical were performed during the 2-week, 3-month, and 2-year studies by the study laboratory using the same turbidity and GC/FID (system B) assays used in the initial bulk chemical purity assays, and no degradation of the bulk chemical was detected.

## VAPOR GENERATION AND EXPOSURE SYSTEM

A diagram of the vapor generation and delivery system used in the studies is shown in Figure I3. Vinylidene chloride was pumped from a disposable 4 liter amber glass generator reservoir into a heated glass flask. Nitrogen entered the flask and assisted in vaporizing the chemical while conveying it from the generator into a short vapor distribution manifold. Concentration in the manifold was determined by the chemical pump and nitrogen flow rates. Pressure in the distribution manifold was kept fixed to ensure constant flows through the manifold and into all chambers as the flow of vapor to each chamber was adjusted.

Individual Teflon® delivery lines carried the vapor from the manifold to three-way exposure valves at the chamber inlets. The exposure valves diverted vapor delivery to the exposure chamber exhaust until the generation system stabilized and exposure could proceed. The flow rate to each chamber was controlled by a metering valve at the

manifold. To initiate exposure, the chamber exposure valves were rotated to allow the vinylidene chloride vapor to flow to each exposure chamber inlet duct where it was diluted with conditioned chamber air to achieve the desired exposure concentration.

The study laboratory designed the inhalation exposure chamber (Harford Systems Division of Lab Products, Inc., Aberdeen, MD) so that uniform vapor concentrations could be maintained throughout the chamber with the catch pans in place. The total active mixing volume of each chamber was 1.7 m<sup>3</sup>. A small particle detector (Model 3022A; TSI, Inc., St. Paul, MN) was used with and without animals in the exposure chambers to ensure that vinylidene chloride vapor, and not aerosol, was produced. No particle counts above the minimum resolvable level (approximately 200 particles/cm<sup>3</sup>) were detected.

## VAPOR CONCENTRATION MONITORING

Summaries of the chamber vapor concentrations are given in Tables I2 through I4. Chamber and room concentrations of vinylidene chloride were monitored by an on-line gas chromatograph (system C, Table I1). Samples were drawn from each exposure chamber approximately three times (2-week and 3-month studies) or twice (2-year studies) per hour during each 6-hour exposure period using Hastelloy<sup>®</sup>-C stream-select and gas-sampling valves (VALCO Instruments Company, Houston, TX) in a separate, heated oven. The sample lines composing each sample loop were made from Teflon<sup>®</sup> tubing and were connected to the exposure chamber relative humidity sampling lines at a location close to the gas chromatograph. A vacuum regulator maintained a constant vacuum in the sample loop to compensate for variations in sample line pressure. An in-line flow meter between the vacuum regulator and the gas chromatograph allowed digital measurement of sample flow.

The on-line gas chromatograph was checked throughout each exposure day for instrument drift against an on-line standard vapor of methylene chloride in nitrogen supplied by a standard generator (Kin-Tek; Precision Calibration Systems, La Marque, TX). The on-line gas chromatograph was recalibrated as required to meet acceptance criteria. Calibration was performed by a comparison of chamber concentration data to data from grab samples collected with activated coconut charcoal gas sampling tubes (ORBO<sup>™</sup>-32; Supelco Inc., Bellefonte, PA), extracted with toluene containing an internal standard of methylene chloride and analyzed using an off-line gas chromatograph equipped with an electron capture detector (system D). Known volumes of chamber atmosphere were sampled at a constant flow rate ensured by a calibrated critical orifice. The off-line gas chromatograph was calibrated with gravimetrically prepared standard solutions of the test chemical containing methylene chloride as an internal standard in toluene.

## CHAMBER ATMOSPHERE CHARACTERIZATION

Buildup and decay rates for chamber vapor concentrations were determined with (all studies) and without (3-month and 2-year studies) animals present in the chambers. At a chamber airflow rate of 15 air changes per hour, the theoretical value for the time to achieve 90% of the target concentration after the beginning of vapor generation ( $T_{90}$ ) and the time for the chamber concentration to decay to 10% of the target concentration after vapor generation was terminated ( $T_{10}$ ) was approximately 9.4 minutes. For rats and mice in the 2-week studies,  $T_{90}$  and  $T_{10}$  values ranged from 9 to 10 minutes with animals present. For rats and mice in the 3-month studies,  $T_{90}$  values ranged from 9 to 11 minutes without animals present and from 10 to 11 minutes with animals;  $T_{10}$  values were 9 to 10 minutes without animals present and 10 minutes with animals. For rats and mice in the 2-year studies,  $T_{90}$  values ranged from 8 to 10 minutes without animals present and from 9 to 12 minutes with animals;  $T_{10}$  values ranged from 9 to 10 minutes without animals present and from 9 to 11 minutes with animals. A  $T_{90}$  value of 12 minutes was selected for the 2-week studies and a  $T_{90}$  value of 10 minutes was selected for the 3-month and 2-year studies.

The uniformity of vinylidene chloride vapor concentration in the inhalation exposure chambers without animals present was evaluated before the 3-month and 2-year studies began; in addition, concentration uniformity with animals present in the chambers was measured once during the 2-week studies, once during the 3-month studies, and approximately quarterly during the 2-year studies. The vapor concentration was measured using the on-line gas chromatograph (system C, Table I1) with the stream-selection valve fixed in one position to allow continuous monitoring from a single input line. During the 2-week studies and prior to the 3-month and 2-year studies, concentrations were measured at 12 chamber positions, one in front and one in back for each of the six possible animal cage unit positions per chamber. During the 3-month and 2-year studies, concentrations were measured at

the regular monitoring port and from sample ports at levels where animals were present. Chamber concentration uniformity was maintained throughout the studies.

The persistence of vinylidene chloride in the chambers after vapor delivery ended was determined by monitoring the vapor concentration in the 400 ppm chambers in the 2-week studies, the 100 ppm chambers in the 3-month studies, and the 100 ppm rat and 25 ppm mouse chambers in the 2-year studies with (all studies) and without (3-month and 2-year studies) animals present in the chambers. In the 2-week studies, the concentration decreased to 1% of the target concentration within 21 minutes with animals present. In the 3-month studies, the concentration decreased to 1% of the target concentration within 21 minutes without animals present and within 23 minutes with animals present. For the 2-year rat studies, the concentration decreased to 1% of the target concentration within 22 minutes with and without animals present; for mice, the concentration decreased to 1% of the target concentration within 18 minutes without animals present and within 21 minutes with animals present.

Samples of the test atmosphere from the distribution lines and the low and high exposure concentration chambers for each species were collected prior to the study without animals present (3-month and 2-year studies) and at the beginning and end of one generation day with animals present during the 2-week, 3-month, and 2-year studies. The atmosphere samples were collected with adsorbent gas sampling tubes containing activated coconut charcoal (ORBO™-32) followed by a tube containing silica gel (ORBO™-52; Supelco, Inc.), and extracted with carbon disulfide. Additional samples were collected from the generator reservoir, and all of the samples were analyzed using GC/FID by system B or a system similar to system B to measure the stability and purity of vinylidene chloride in the generation and delivery system. To assess whether impurities or degradation products co-eluted with vinylidene chloride or the solvent, a second GC/FID analysis of the samples was performed using a polar column capable of resolving compounds with similar boiling points and polarities (system E). Separate atmosphere samples were collected in these studies using toluene bubblers; MEHQ inhibitor was assayed in these distribution line samples using GC/FID by system A, and peroxide was assayed in these distribution line and low (except 2-week studies) and high exposure concentration chamber samples by KI titration. HCL, formaldehyde, and phosgene concentrations were measured in atmosphere samples collected during the last 2 hours of a 6-hour generation day. Fourier transform IR spectroscopy was used to measure the presence of HCL in samples collected prior to the 3-month studies and during the 2-week, 3-month, and 2-year studies; spectra were generated using a MIDAC I-1101 spectroscope (MIDAC Corporation, Irvine, CA) equipped with a 9.5 m pathlength gas cell held at approximately 25° C and were compared to those of prepared HCL standards. Formaldehyde and phosgene were measured in atmosphere samples collected on silica adsorbent sampling tubes coated with 2,4-dinitrophenylhydrazine (LpDNPH H10 or S10; Supelco, Inc.) prior to the 3-month and 2-year studies and during the 2-week, 3-month, and 2-year studies. These samples were analyzed using a liquid chromatography procedure conducted with a Hewlett-Packard liquid chromatograph (Hewlett-Packard, Palo Alto, CA) equipped with a Phenomenex C<sub>18</sub> (250mm × 4.6 mm, 5µm) column (Phenomenex, Torrance, CA). The mobile phase (1.2 mL/minute) consisted of acetonitrile:water:tetrahydrofuran:2-propanol [ A) 30:59:10:1; B) 65:35:0:0; and C) 100:0:0:0]; the analysis utilized a solvent program of a linear gradient from 100% A to 60% A:40% B in 20 minutes, held for 5 minutes, then a linear gradient to 100% B in 10 minutes followed by linear gradient to 100% C in 2 minutes, held for 10 minutes, and then a linear gradient to 100% A in 0.1 minutes. Absorbance was recorded at 355 nm. Samples were collected from the generator reservoir 3 to 14 days after the reservoir was placed in use in studies conducted without animals present prior to the 3-month and 2-year studies and at the same timepoints during the 2-week, 3-month, and 2-year studies. These samples were analyzed for area percent purity, polymer formation, peroxide content, and MEHQ concentration using the same methodologies employed for the initial bulk chemical characterization assays.

No evidence of degradation of vinylidene chloride was noted in any part of the exposure system in any of the samples collected prior to the 3-month and 2-year studies or during the 2-week, 3-month, and 2-year studies. No impurity peaks with areas greater than 0.1% of the total peak area were detected in atmosphere or generator reservoir samples and no additional impurities were found in any of the atmosphere or reservoir samples using the polar column. HCL concentrations in the atmosphere samples were consistently determined to be less than the detection limit. Formaldehyde and phosgene concentrations were less than 0.1% by weight compared to vinylidene chloride in all distribution line and chamber atmosphere samples. Acceptable, low concentrations of peroxide as active oxygen relative to vinylidene chloride were found in all atmosphere samples. All distribution line samples contained concentrations within the acceptable range for the inhibitor MEHQ relative to vinylidene chloride. No evidence of degradation, peroxide formation, or polymer formation was noted in any of the samples taken from the generator reservoir after multiple days of use.

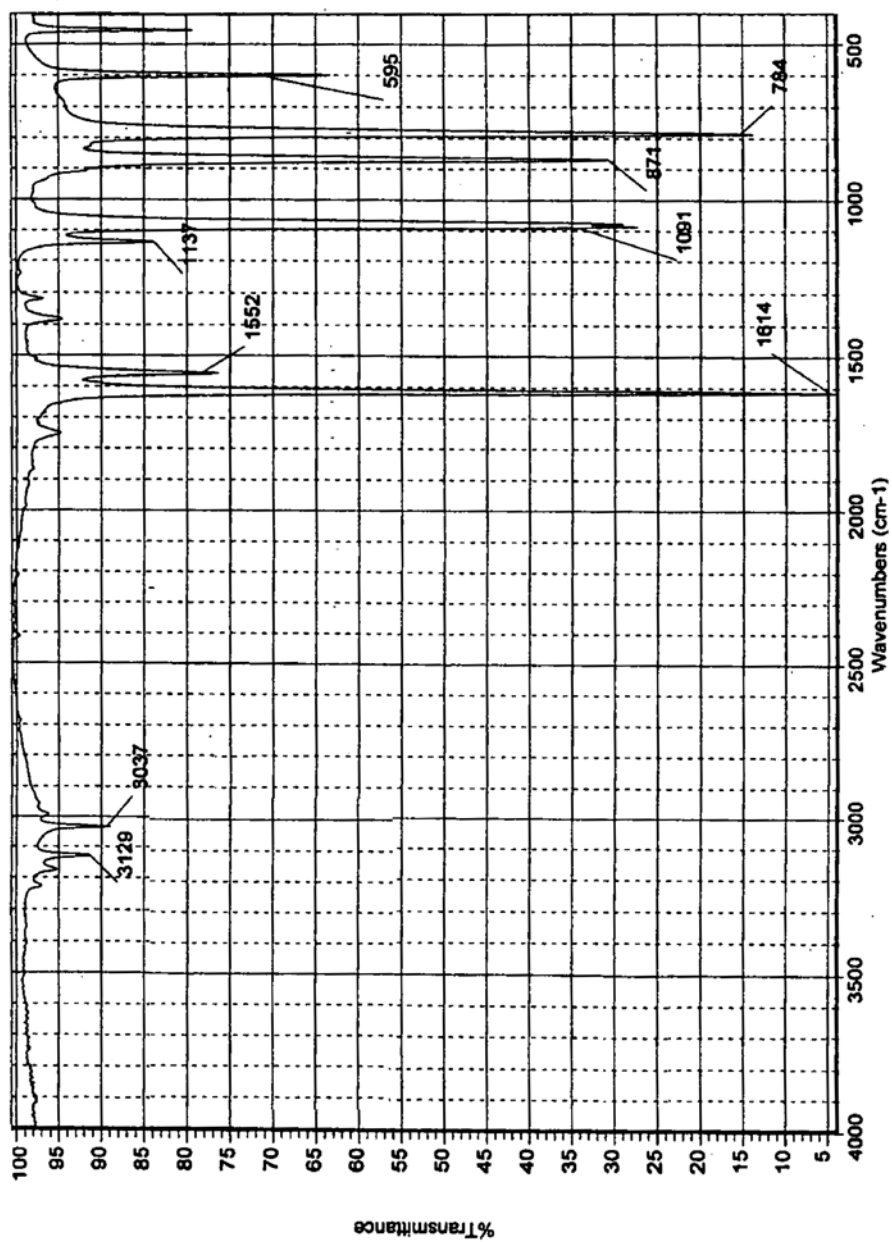
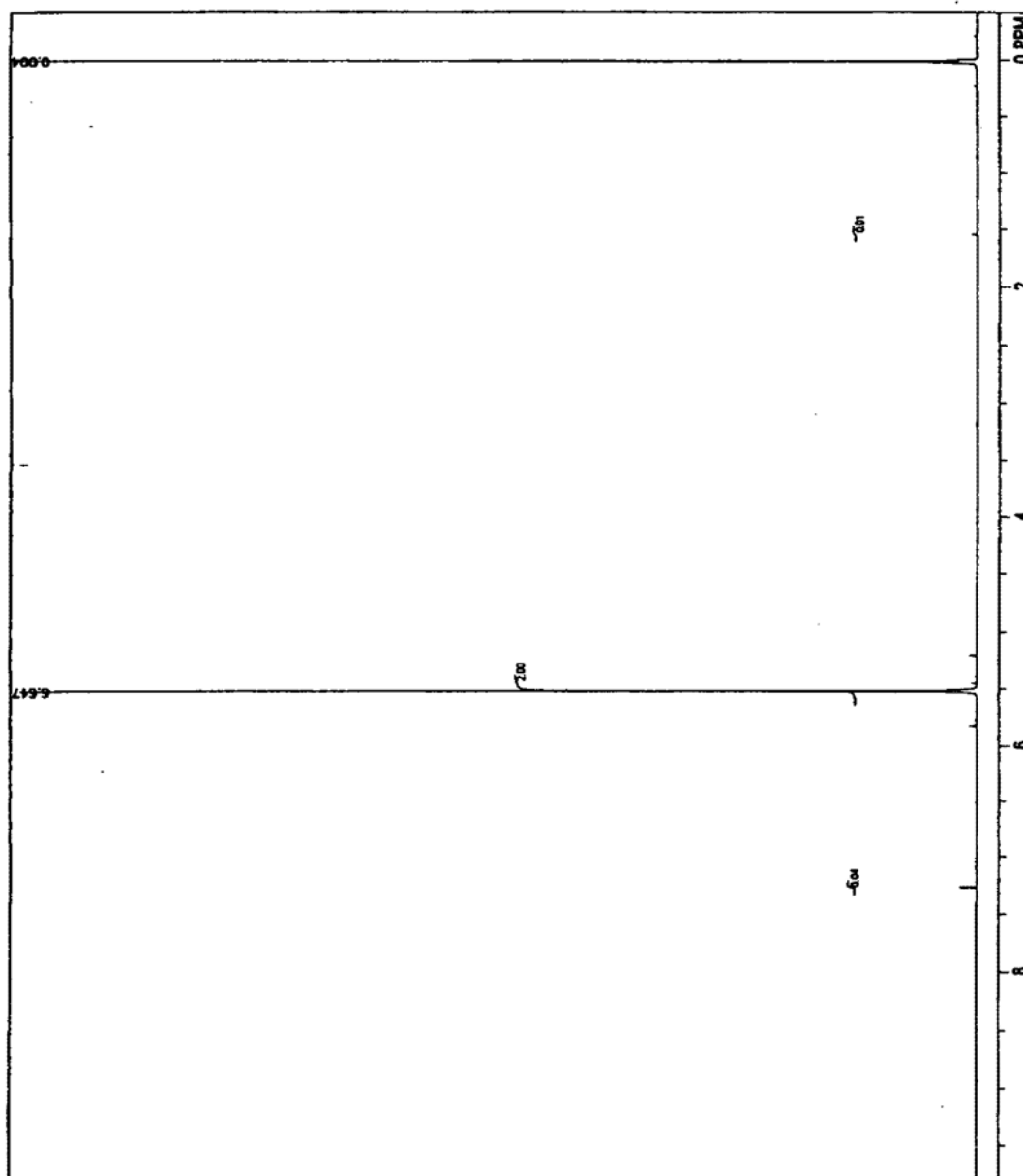


FIGURE II  
Infrared Absorption Spectrum of Vinylidene Chloride

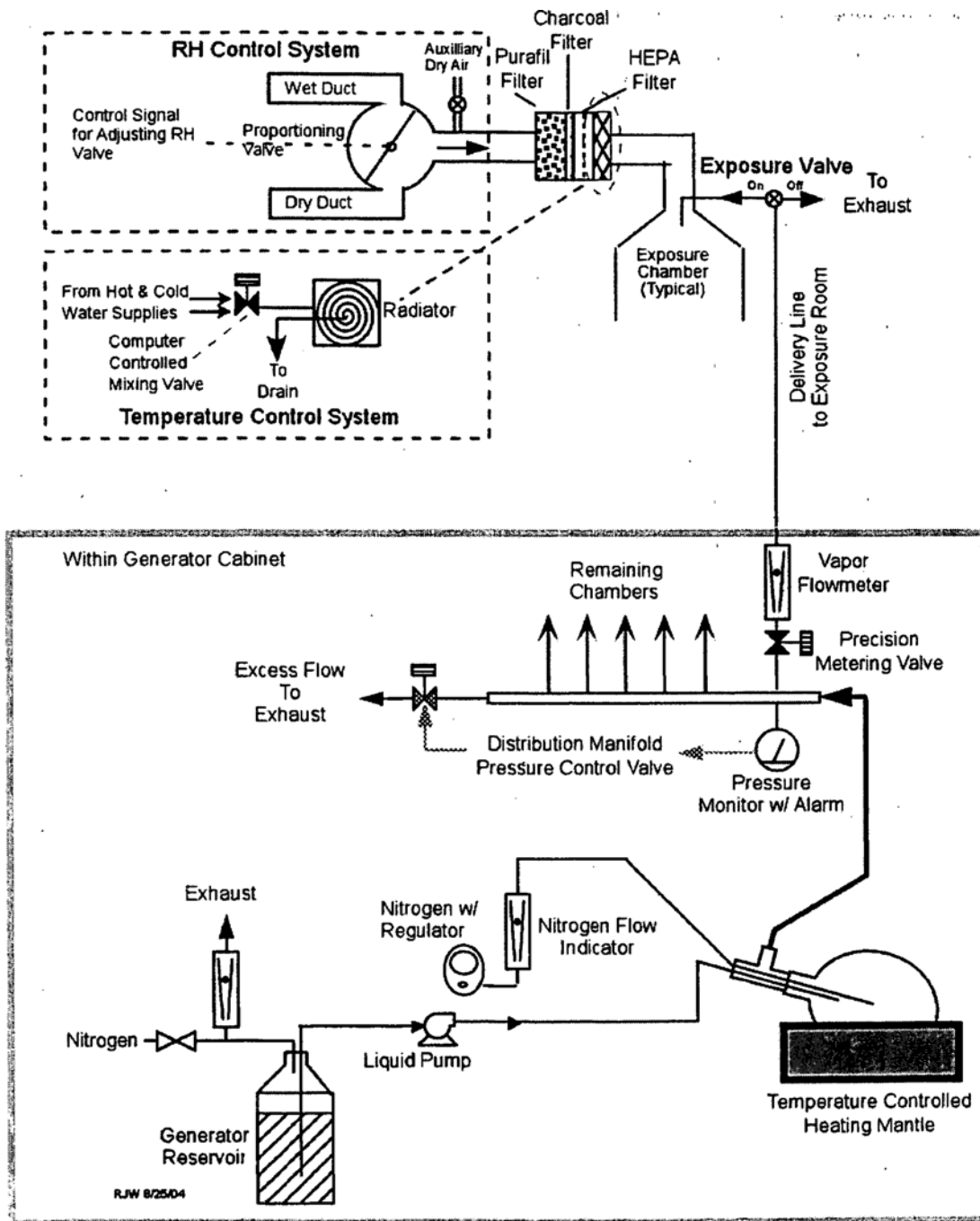


**FIGURE I2**  
**Proton Nuclear Magnetic Resonance Spectrum of Vinylidene Chloride**

**TABLE II**  
**Gas Chromatography Systems Used in the Inhalation Studies of Vinylidene Chloride<sup>a</sup>**

Detection System	Column	Carrier Gas	Oven Temperature Program
<b>System A</b> Flame ionization	DB-5, 30 m × 0.53 mm, 1.5 µm film (J&W Scientific, Folsom, CA)	Helium at 12 psi head pressure	90° C for 1 minute, then 12° C/minute to 200° C
<b>System B</b> Flame ionization	DB-624, 30 m × 0.53 mm, 3.0 µm film (J&W Scientific)	Helium at 2.5 psi head pressure	35° C for 3 minutes, then 4° C/minute to 110° C, then 8° C/minute to 260° C
<b>System C</b> Flame ionization	Rtx <sup>®</sup> -624, 30 m × 0.53 mm, 5.0 µm film (Restek, Bellefonte, PA)	Nitrogen at ~25 mL/minute	Isothermal at 60° C
<b>System D</b> Electron capture	Rtx <sup>®</sup> -624, 30 m × 0.53 mm, 5.0 µm film (Restek)	Nitrogen at ~3.5 mL/minute	45° C for 1 minute, then 3° C/minute to 70° C, then 15° C/minute to 160° C
<b>System E</b> Flame ionization	DB WAX, 30 m × 0.53 mm, 1.0 µm film (J&W Scientific)	Helium at 12 psi head pressure	90° C for 1 minute, then 12° C/minute to 200° C

<sup>a</sup> The gas chromatographs were manufactured by Hewlett-Packard (Palo Alto, CA)



**FIGURE I3**  
Schematic of the Vapor Generation and Delivery System in the Inhalation Studies of Vinylidene Chloride

**TABLE I2**  
**Summary of Chamber Concentrations in the 2-Week Inhalation Studies of Vinylidene Chloride**

	Total Concentration (ppm)	Total Number of Readings	Average Concentration <sup>a</sup> (ppm)
<b>Rat Chambers</b>			
	25	200	25.1 ± 0.5
	50	201	50.1 ± 1.3
	100	202	99.7 ± 4.3
	200	16	200 ± 1
	400	64	398 ± 34
<b>Mouse Chambers</b>			
	25	218	25.1 ± 0.5
	50	219	50.1 ± 1.3
	100	220	99.7 ± 4.1
	200	16	200 ± 1
	400	19	396 ± 2

<sup>a</sup> Mean ± standard deviation

**TABLE I3**  
**Summary of Chamber Concentrations in the 3-Month Inhalation Studies of Vinylidene Chloride**

	Total Concentration (ppm)	Total Number of Readings	Average Concentration <sup>a</sup> (ppm)
<b>Rat Chambers</b>			
	6.25	1,193	6.28 ± 0.12
	12.5	1,183	12.6 ± 0.2
	25	1,185	25.1 ± 0.5
	50	1,210	50.4 ± 1.0
	100	1,224	100.0 ± 2.2
<b>Mouse Chambers</b>			
	6.25	1,232	6.28 ± 0.12
	12.5	1,220	12.6 ± 0.2
	25	1,223	25.1 ± 0.5
	50	1,249	50.4 ± 1.0
	100	1,263	100.0 ± 2.2

<sup>a</sup> Mean ± standard deviation



**TABLE I4**  
**Summary of Chamber Concentrations in the 2-Year Inhalation Studies of Vinylidene Chloride**

	Total Concentration (ppm)	Total Number of Readings	Average Concentration <sup>a</sup> (ppm)
<b>Rat Chambers</b>			
	25	7,938	25.0 ± 0.6
	50	7,963	50.1 ± 1.1
	100	7,968	100.0 ± 2.3
<b>Mouse Chambers</b>			
	6.25	8,315	6.22 ± 0.16
	12.5	8,022	12.5 ± 0.3
	25	7,917	25.0 ± 0.4

<sup>a</sup> Mean ± standard deviation

**APPENDIX J**  
**INGREDIENTS, NUTRIENT COMPOSITION,**  
**AND CONTAMINANT LEVELS**  
**IN NTP-2000 RAT AND MOUSE RATION**

<b>TABLE J1</b>	<b>Ingredients of NTP-2000 Rat and Mouse Ration .....</b>	<b>J-2</b>
<b>TABLE J2</b>	<b>Vitamins and Minerals in NTP-2000 Rat and Mouse Ration.....</b>	<b>J-2</b>
<b>TABLE J3</b>	<b>Nutrient Composition of NTP-2000 Rat and Mouse Ration.....</b>	<b>J-3</b>
<b>TABLE J4</b>	<b>Contaminant Levels in NTP-2000 Rat and Mouse Ration .....</b>	<b>J-4</b>

**TABLE J1**  
**Ingredients of NTP-2000 Rat and Mouse Ration**

Ingredients	Percent by Weight
Ground hard winter wheat	22.26
Ground #2 yellow shelled corn	22.18
Wheat middlings	15.0
Oat hulls	8.5
Alfalfa meal (dehydrated, 17% protein)	7.5
Purified cellulose	5.5
Soybean meal (49% protein)	5.0
Fish meal (60% protein)	4.0
Corn oil (without preservatives)	3.0
Soy oil (without preservatives)	3.0
Dried brewer's yeast	1.0
Calcium carbonate (USP)	0.9
Vitamin premix <sup>a</sup>	0.5
Mineral premix <sup>b</sup>	0.5
Calcium phosphate, dibasic (USP)	0.4
Sodium chloride	0.3
Choline chloride (70% choline)	0.26
Methionine	0.2

<sup>a</sup> Wheat middlings as carrier

<sup>b</sup> Calcium carbonate as carrier

**TABLE J2**  
**Vitamins and Minerals in NTP-2000 Rat and Mouse Ration<sup>a</sup>**

	Amount	Source
<b>Vitamins</b>		
A	4,000 IU	Stabilized vitamin A palmitate or acetate
D	1,000 IU	D-activated animal sterol
K	1.0 mg	Menadione sodium bisulfite complex
$\alpha$ -Tocopheryl acetate	100 IU	
Niacin	23 mg	
Folic acid	1.1 mg	
<i>d</i> -Pantothenic acid	10 mg	<i>d</i> -Calcium pantothenate
Riboflavin	3.3 mg	
Thiamine	4 mg	Thiamine mononitrate
B <sub>12</sub>	52 $\mu$ g	
Pyridoxine	6.3 mg	Pyridoxine hydrochloride
Biotin	0.2 mg	<i>d</i> -Biotin
<b>Minerals</b>		
Magnesium	514 mg	Magnesium oxide
Iron	35 mg	Iron sulfate
Zinc	12 mg	Zinc oxide
Manganese	10 mg	Manganese oxide
Copper	2.0 mg	Copper sulfate
Iodine	0.2 mg	Calcium iodate
Chromium	0.2 mg	Chromium acetate

<sup>a</sup> Per kg of finished product

**TABLE J3**  
**Nutrient Composition of NTP-2000 Rat and Mouse Ration**

Nutrient	Mean ± Standard Deviation	Range	Number of Samples
Protein (% by weight)	14.7 ± 0.65	13.5 – 16.3	24
Crude fat (% by weight)	8.3 ± 0.33	7.8 – 9.3	24
Crude fiber (% by weight)	9.1 ± 0.55	8.1 – 10.0	24
Ash (% by weight)	4.9 ± 0.23	4.4 – 5.4	24
<b>Amino Acids (% of total diet)</b>			
Arginine	0.783 ± 0.070	0.670 – 0.970	22
Cystine	0.220 ± 0.024	0.150 – 0.250	22
Glycine	0.701 ± 0.041	0.620 – 0.800	22
Histidine	0.352 ± 0.077	0.270 – 0.680	22
Isoleucine	0.546 ± 0.044	0.430 – 0.660	22
Leucine	1.095 ± 0.067	0.960 – 1.240	22
Lysine	0.711 ± 0.114	0.310 – 0.860	22
Methionine	0.409 ± 0.046	0.260 – 0.490	22
Phenylalanine	0.628 ± 0.040	0.540 – 0.720	22
Threonine	0.505 ± 0.043	0.430 – 0.610	22
Tryptophan	0.150 ± 0.028	0.110 – 0.200	22
Tyrosine	0.401 ± 0.061	0.280 – 0.540	22
Valine	0.665 ± 0.043	0.550 – 0.730	22
<b>Essential Fatty Acids (% of total diet)</b>			
Linoleic	3.95 ± 0.259	3.49 – 4.55	22
Linolenic	0.30 ± 0.032	0.21 – 0.35	22
<b>Vitamins</b>			
Vitamin A (IU/kg)	3,755 ± 64	2,340 – 5,080	24
Vitamin D (IU/kg)	1,000 <sup>a</sup>		
α-Tocopherol (ppm)	80.6 ± 22.03	27.0 – 124.0	22
Thiamine (ppm) <sup>b</sup>	7.5 ± 1.08	5.5 – 10.0	24
Riboflavin (ppm)	7.6 ± 2.89	4.20 – 17.50	22
Niacin (ppm)	78.9 ± 9.08	66.4 – 98.2	22
Pantothenic acid (ppm)	26.9 ± 12.63	17.4 – 81.0	22
Pyridoxine (ppm) <sup>b</sup>	9.54 ± 1.99	6.44 – 13.7	22
Folic acid (ppm)	1.62 ± 0.48	1.15 – 3.27	22
Biotin (ppm)	0.32 ± 0.10	0.20 – 0.704	22
Vitamin B <sub>12</sub> (ppb)	53.6 ± 39.6	18.3 – 174.0	22
Choline (ppm) <sup>b</sup>	2,846 ± 485	1,820 – 3,790	22
<b>Minerals</b>			
Calcium (%)	0.953 ± 0.055	0.865 – 1.080	24
Phosphorus (%)	0.549 ± 0.028	0.499 – 0.607	24
Potassium (%)	0.666 ± 0.030	0.626 – 0.733	22
Chloride (%)	0.386 ± 0.039	0.300 – 0.474	22
Sodium (%)	0.189 ± 0.016	0.160 – 0.222	22
Magnesium (%)	0.216 ± 0.062	0.185 – 0.490	22
Sulfur (%)	0.170 ± 0.029	0.116 – 0.209	14
Iron (ppm)	186 ± 39.2	135 – 311	22
Manganese (ppm)	51.4 ± 10.28	21.0 – 73.1	22
Zinc (ppm)	53.4 ± 8.46	43.3 – 78.5	22
Copper (ppm)	7.01 ± 2.562	3.21 – 16.3	22
Iodine (ppm)	0.503 ± 0.206	0.158 – 0.972	22
Chromium (ppm)	0.694 ± 0.276	0.330 – 1.380	22
Cobalt (ppm)	0.256 ± 0.164	0.098 – 0.864	22

<sup>a</sup> From formulation

<sup>b</sup> As hydrochloride (thiamine and pyridoxine) or chloride (choline)

**TABLE J4**  
**Contaminant Levels in NTP-2000 Rat and Mouse Ration<sup>a</sup>**

	Mean ± Standard Deviation <sup>b</sup>	Range	Number of Samples
<b>Contaminants</b>			
Arsenic (ppm)	0.25 ± 0.066	0.16 – 0.40	24
Cadmium (ppm)	0.05 ± 0.008	0.04 – 0.07	24
Lead (ppm)	0.09 ± 0.011	0.07 – 0.15	24
Mercury (ppm)	<0.02		24
Selenium (ppm)	0.35 ± 0.195	0.18 – 0.97	24
Aflatoxins (ppb)	<5.00		24
Nitrate nitrogen (ppm) <sup>c</sup>	13.88 ± 7.43	4.8 – 36.8	24
Nitrite nitrogen (ppm) <sup>c</sup>	1.86 ± 1.64	0.30 – 4.99	24
BHA (ppm) <sup>d</sup>	1.17 ± 0.82	1.0 – 5.0	24
BHT (ppm) <sup>d</sup>	1.17 ± 0.82	1.0 – 5.0	24
Aerobic plate count (CFU/g)	10 ± 0.0	10 – 10	24
Coliform (MPN/g)	3.0 ± 0.0	3.0 – 3.0	24
<i>Escherichia coli</i> (MPN/g)	<10		24
<i>Salmonella</i> (MPN/g)	Negative		24
Total nitrosoamines (ppb) <sup>e</sup>	4.7 ± 1.90	2.0 – 9.9	24
<i>N</i> -Nitrosodimethylamine (ppb) <sup>e</sup>	2.5 ± 1.25	1.0 – 6.3	24
<i>N</i> -Nitrosopyrrolidine (ppb) <sup>e</sup>	2.2 ± 1.23	1.0 – 6.1	24
<b>Pesticides (ppm)</b>			
α-BHC	<0.01		24
β-BHC	<0.02		24
γ-BHC	<0.01		24
δ-BHC	<0.01		24
Heptachlor	<0.01		24
Aldrin	<0.01		24
Heptachlor epoxide	<0.01		24
DDE	<0.01		24
DDD	<0.01		24
DDT	<0.01		24
HCB	<0.01		24
Mirex	<0.01		24
Methoxychlor	<0.05		24
Dieldrin	<0.01		24
Endrin	<0.01		24
Telodrin	<0.01		24
Chlordane	<0.05		24
Toxaphene	<0.10		24
Estimated PCBs	<0.20		24
Ronnel	<0.01		24
Ethion	<0.02		24
Trithion	<0.05		24
Diazinon	<0.10		24
Methyl chlorpyrifos	0.075 ± 0.048	0.010 – 0.186	24
Methyl parathion	<0.02		24
Ethyl parathion	<0.02		24
Malathion	0.221 ± 0.249	0.020 – 0.997	24
Endosulfan I	<0.01		24
Endosulfan II	<0.01		24
Endosulfan sulfate	<0.03		24

<sup>a</sup> All samples were irradiated. CFU=colony-forming units; MPN=most probable number; BHC=hexachlorocyclohexane or benzene hexachloride

<sup>b</sup> For values less than the limit of detection, the detection limit is given as the mean.

<sup>c</sup> Sources of contamination: alfalfa, grains, and fish meal

<sup>d</sup> Sources of contamination: soy oil and fish meal

<sup>e</sup> All values were corrected for percent recovery.

# APPENDIX K

## SENTINEL ANIMAL PROGRAM

<b>METHODS</b> .....	<b>K-2</b>
<b>RESULTS</b> .....	<b>K-4</b>

# SENTINEL ANIMAL PROGRAM

## METHODS

Rodents used in the National Toxicology Program are produced in optimally clean facilities to eliminate potential pathogens that may affect study results. The Sentinel Animal Program is part of the periodic monitoring of animal health that occurs during the toxicologic evaluation of test compounds. Under this program, the disease state of the rodents is monitored via sera or feces from extra (sentinel) or dosed animals in the study rooms. The sentinel animals and the study animals are subject to identical environmental conditions. Furthermore, the sentinel animals come from the same production source and weanling groups as the animals used for the studies of test compounds.

Blood samples were collected, allowed to clot, and the serum was separated. Additionally, fecal samples were collected and tested for *Helicobacter* species. All samples were processed appropriately and tested in-house or sent to BioReliance Corporation (Rockville, MD) for determination of the presence of pathogens. The laboratory methods and agents for which testing was performed are tabulated below; the times at which samples were collected during the studies are also listed.

Blood was collected from five animals per sex at each time point except four female mice at 12 months and four male rats at 18 months. Fecal samples were collected from five male and five female mice.

### Method and Test

### Time of Collection

## RATS

### 2-Week Study

In-house Antibody Testing

<i>Mycoplasma pulmonis</i>	Study termination
PVM (pneumonia virus of mice)	Study termination
RCV/SDA (rat coronavirus/sialodacryoadenitis virus)	Study termination
RPV (rat parvovirus)	Study termination
Sendai	Study termination

### 3-Month Study

In-house Antibody Testing

<i>M. pulmonis</i>	2 weeks
PVM	2 weeks
RCV/SDA	2 weeks
RPV	2 weeks
Sendai	2 weeks

ELISA

<i>Mycoplasma arthritidis</i>	Study termination
<i>M. pulmonis</i>	Study termination
PVM	Study termination
RCV/SDA	Study termination
Sendai	Study termination

Immunofluorescence Assay

Parvovirus	Study termination
------------	-------------------

**Method and Test****Time of Collection****RATS** (continued)**2-Year Study**

## In-house Antibody Testing

<i>M. pulmonis</i>	2 weeks
PVM	2 weeks
RCV/SDA	2 weeks
RPV	2 weeks
Sendai	2 weeks

## ELISA

<i>M. arthritidis</i>	Study termination
<i>M. pulmonis</i>	Study termination
PVM	6, 12, and 18 months, study termination
RCV/SDA	6, 12, and 18 months, study termination
Sendai	6, 12, and 18 months, study termination

## Immunofluorescence Assay

Parvovirus	6, 12, and 18 months, study termination
------------	---

**MICE****2-Week Study**

## In-house Antibody Testing

GDVII (Theiler's murine encephalomyelitis virus)	Study termination
MHV (mouse hepatitis virus)	Study termination
MPV (mouse parvovirus)	Study termination
<i>M. pulmonis</i>	Study termination
PVM	Study termination
Sendai	Study termination

**3-Month Study**

## In-house Antibody Testing

GDVII	2 weeks
MHV	2 weeks
MPV	2 weeks
<i>M. pulmonis</i>	2 weeks
PVM	2 weeks
Sendai	2 weeks

## ELISA

Ectromelia virus	Study termination
EDIM (epizootic diarrhea of infant mice)	Study termination
GDVII	Study termination
LCM (lymphocytic choriomeningitis virus)	Study termination
MAd-FL (mouse adenovirus)	Study termination
MHV	Study termination
MMV VP2 (mouse minute virus)	Study termination
MPV VP2 (mouse parvovirus)	Study termination
<i>M. arthritidis</i>	Study termination
<i>M. pulmonis</i>	Study termination
PVM	Study termination



**Method and Test****Time of Collection****MICE** (continued)**3-Month Study**

## ELISA (continued)

Reovirus

Study termination

Sendai

Study termination

## Immunofluorescence Assay

MCMV (mouse cytomegalovirus)

Study termination

**2-Year Study**

## In-house Antibody Testing

GDVII

2 weeks

MHV

2 weeks

MPV

2 weeks

*M. pulmonis*

2 weeks

PVM

2 weeks

Sendai

2 weeks

## ELISA

Ectromelia virus

6, 12, and 18 months, study termination

EDIM

6, 12, and 18 months, study termination

GDVII

6, 12, and 18 months, study termination

LCM

6, 12, and 18 months, study termination

MAAd-1

6, 12, and 18 months, study termination

MHV

6, 12, and 18 months, study termination

MMV VP2

6, 12, and 18 months, study termination

MPV VP2

6, 12, and 18 months, study termination

*M. arthritidis*

Study termination

*M. pulmonis*

Study termination

PVM

6, 12, and 18 months, study termination

Reovirus

6, 12, and 18 months, study termination

Sendai

6, 12, and 18 months, study termination

## Immunofluorescence Assay

EDIM

12 and 18 months

GDVII

18 months

MCMV

18 months

MMV

12 and 18 months

MPV

18 months

PVM

18 months

Reovirus

12 months

## Polymerase Chain Reaction

*Helicobacter* species

18 months

**RESULTS**

All test results were negative.

# APPENDIX L

## GLOBAL GENE PROFILING OF MESOTHELIOMA IN VINYLIDENE CHLORIDE-EXPOSED F344/N RATS

Pamela E. Blackshear<sup>1,5</sup>, Arun R. Pandiri<sup>1,6</sup>, Sachin Bhusari<sup>1</sup>, Lily Hong, Thai-Vu T. Ton<sup>1</sup>,  
Natasha P. Clayton<sup>1</sup>, Michael Wyde<sup>2</sup>, Keith R. Shockley<sup>3</sup>, Shyamal D. Peddada<sup>3</sup>, Kevin E. Gerrish<sup>4</sup>,  
Robert C. Sills<sup>1</sup>, and Mark J. Hoenerhoff<sup>1</sup>

<sup>1</sup>Cellular and Molecular Pathology Branch and <sup>2</sup>Experimental Toxicology Group,  
Division of the National Toxicology Program,

<sup>3</sup>Biostatistics Branch and <sup>4</sup>Laboratory of Toxicology and Pharmacology,  
National Institute of Environmental Health Sciences,  
Research Triangle Park, NC;

<sup>5</sup>ILS, Inc., Research Triangle Park, NC;

<sup>6</sup>Experimental Pathology Laboratories, Inc., Research Triangle Park, NC

<b>INTRODUCTION</b> .....		L-2
<b>MATERIALS AND METHODS</b> .....		L-2
<b>RESULTS</b> .....		L-3
<b>DISCUSSION</b> .....		L-4
<b>REFERENCES</b> .....		L-5
<b>TABLE L1</b>	<b>Spontaneous and Vinylidene Chloride-Exposed Malignant Mesotheliomas from Male F344/N Rats Used for Genomic Profiling</b> .....	L-7
<b>FIGURE L1</b>	<b>Principal Component Analysis Comparing Global Gene Profiles of Fred-PE Mesothelial Cells (red), Spontaneous Mesotheliomas from Control Rats (blue), and Mesotheliomas from Vinylidene Chloride-Exposed Rats (green)</b> .....	L-8
<b>FIGURE L2</b>	<b>Comparison Analysis of Spontaneous and Vinylidene Chloride-Exposed Mesothelioma Microarray Datasets</b> .....	L-9
<b>TABLE L2</b>	<b>Selected Significantly Expressed Pathways in Mesotheliomas from Vinylidene Chloride-Exposed and Control F344/N Rats (P &lt; 0.001) Compared to Fred-PE Cells</b> .....	L-10
<b>TABLE L3</b>	<b>Selected Differentially Expressed Genes Associated with Inflammation and Immune Response in Vinylidene Chloride-Exposed Compared to Spontaneous Mesotheliomas from F344/N Rats (P &lt; 0.001)</b> .....	L-12
<b>TABLE L4</b>	<b>Quantitative PCR (qPCR) Validation of Gene Expression Changes on Microarray of Spontaneous and Vinylidene Chloride-Exposed Mesotheliomas in F344/N Rats</b> .....	L-14

# GLOBAL GENE PROFILING OF MESOTHELIOMA IN VINYLIDENE CHLORIDE-EXPOSED F344/N RATS

## INTRODUCTION

The 2-year National Toxicology Program (NTP) bioassay indicated that male F344/N rats exposed to vinylidene chloride had statistically significant increases in the incidences of malignant mesotheliomas arising from the tunica vaginalis of the testes. The goal of this study was to investigate global gene expression alterations in mesotheliomas from vinylidene chloride-exposed animals in order to elucidate their chemical-specific gene profiles compared to spontaneous mesotheliomas. We compared global gene expression profiles of mesotheliomas from vinylidene chloride-exposed male F344/N rats, spontaneous mesotheliomas in control male F344/N rats from three other NTP studies (codeine, riddelliine, cobalt metal; NTP, 1996, 2003, 2013), and the immortalized, nontransformed, F344/N rat peritoneal mesothelial cell line (Fred-PE) as a control.

## MATERIALS AND METHODS

### Sample Collection

For collection of frozen tissues for molecular biology analysis in NTP studies, sections of background and treatment-related tumors or suspect tumors and corresponding tumors from untreated control male and female rats and mice are collected and frozen for animals sacrificed moribund and those sacrificed at study termination. When a tumor is at least 0.5 cm in diameter, one-half of that tumor is collected for fixation in 10% neutral buffered formalin (NBF), and the other corresponding half is flash frozen in liquid nitrogen. Sections of frozen tissue are then utilized for isolation of nucleic acids for quantitative PCR (qPCR) or microarray analysis (RNA), mutation analysis or methylation profiling (DNA), or western blotting or other protein measurements or analyses (protein). In this study, mesothelioma samples were collected from vinylidene chloride-exposed male F344/N rats and frozen sections were used for isolation of RNA for global gene expression profiling analysis and qPCR. Spontaneous mesotheliomas from control male F344/N or F344/NTac rats from other NTP studies (codeine, riddelliine, cobalt metal; NTP, 1996, 2003, 2013) were available in the NTP frozen tissue repository for analysis (Table L1). A nontransformed, immortalized mesothelioma cell line was used as a nontumor mesothelial control, as described in previous studies (Crosby *et al.*, 2000; Kim *et al.*, 2006). Fred-PE cells were originally isolated by Dr. DeAngelo (Environmental Protection Agency) and were prepared from the peritoneal cavities of normal F344 male rats. The identity of these cells was previously confirmed by dual immunostaining with pan-cytokeratin and vimentin. RNA from Fred-PE control mesothelioma cells was obtained as a generous gift from Dr. Yongbaek Kim, North Carolina State University. Mesothelioma samples for analysis were chosen based on the criteria of size and tumor viability. Tumor size and viability were chosen as criteria for tumor selection in order to maximize the amount and quality of RNA obtained for microarray analysis. Tumor viability was assessed by histopathology of adjacent NBF-fixed, paraffin-embedded samples matched with the frozen samples, in order to choose samples with minimal to no autolysis, necrosis, or hemorrhage.

### Extraction and Quantification of RNA

Extraction of RNA was performed using the Invitrogen PureLink<sup>®</sup> Mini Kit (Invitrogen catalog no. 12183018A; Invitrogen Corporation, Carlsbad, CA). Frozen tissue samples were lysed and homogenized in TRIzol<sup>®</sup> reagent (Invitrogen Corporation) using a rotor-stator homogenizer. Isolation of RNA was performed according to Mini Kit protocol. On-column DNase treatment was performed using the PureLink<sup>®</sup> DNase kit (Invitrogen Corporation) to purify RNA samples. RNA quantification and RNA integrity number were measured on a bioanalyzer (Agilent Technologies, Santa Clara, CA). Samples were aliquoted and stored at -80° C until analyzed.

### RNA Labeling, Microarray Hybridization, and Data Processing

Gene expression analysis was conducted by the National Institute of Environmental Health Sciences, Microarray Core Laboratory using Affymetrix Rat Genome 230 2.0 GeneChip<sup>®</sup> arrays (Affymetrix, Santa Clara, CA). 100 ng of total RNA were amplified according to the Affymetrix 3' IVT Express kit protocol. Amplified biotin-labeled RNA (12.5 µg) was fragmented, then 10 µg of sample was hybridized to each array according to the Affymetrix Eukaryotic Target Hybridization protocol, using the provided control input RNA. Array slides were double stained

with streptavidin and phycoerythrin and washed for antibody amplification according to the GeneChip<sup>®</sup> Hybridization, Wash, and Stain Kit user manual. Arrays were scanned in an Affymetrix Scanner 3000, and data was obtained using the GeneChip<sup>®</sup> Command Console Software (AGCC; Version 1.1) using the MAS5 algorithm to generate .CHP files.

Probe intensity data from all arrays were entered into the R software environment <<http://www.R-project.org>> directly from .cel files using the R/affy package (Gautier *et al.*, 2004). Image reconstruction, intensity histograms, and boxplots were used to evaluate data quality. During quality control procedures, image reconstruction indicated that one vinylidene chloride sample had a large smudge (animal 604), so this sample was removed from the analysis. The remaining 19 samples (six Fred-PE cell lines, five spontaneous mesotheliomas, eight vinylidene chloride-exposed mesotheliomas) were normalized using the robust multiarray average (RMA) method to form one expression measure for each gene on each array (Irizarry *et al.*, 2003). The RMA method adjusts the background of perfect match (PM) probes, applies a quantile normalization of the corrected PM values, and calculates final expression measures using the Tukey median polish algorithm. Pairwise comparisons were made for each probeset in each experimental group (Fred-PE cells, spontaneous mesothelioma, vinylidene chloride-exposed mesothelioma) using a bootstrap t test while controlling for the mixed directional false discovery rate (mdFDR) at 0.05 (5%). The mdFDR procedure controls the overall false discovery rate across multiple comparisons and takes into account directional errors corresponding to upregulated or downregulated genes (Guo *et al.*, 2010). Statistical calculations were performed in the ORIOGEN software package using 10,000 bootstrap samples (Peddada *et al.*, 2005).

A core analysis comparing the three experimental groups (Fred-PE mesothelial cells, spontaneous mesotheliomas, and vinylidene chloride-exposed mesotheliomas) was performed to identify differentially expressed genes in vinylidene chloride-exposed and spontaneous mesotheliomas compared to Fred-PE mesothelial cells. A comparison analysis of the significantly differentially expressed genes between spontaneous mesotheliomas and vinylidene chloride-exposed mesotheliomas was then performed to identify relevant biologic functions, canonical pathways, and transcription factor activation. Through testing for the association of gene products with a curated database of biological networks [Ingenuity Pathways Analysis<sup>™</sup> (IPA) version 9.0; Ingenuity Systems, Inc., Redwood City, CA] <<http://www.ingenuity.com/>>, overrepresented gene categories were identified. Significantly differentially expressed genes ( $P < 0.001$ ) in the IPA core analysis were then grouped by pathways to account for upstream and downstream effectors as well as overlapping pathways. Upstream activation was based on an IPA Z-score of greater than 2.0 with no bias. All .cel files are available in the Chemical Effects in Biological Systems database <<http://www.niehs.nih.gov/research/resources/databases/cebs/index.cfm>>.

## RESULTS

Global gene expression analysis enabled the identification of distinct genomic signatures that differentiated between mesotheliomas in vinylidene chloride-exposed animals and spontaneous mesotheliomas in control animals. Using a principal component analysis, there was distinct clustering of samples within each experimental group, while there was clear separation of samples between each experimental group, based on significantly differentially expressed genes (Figure L1). Using Fred-PE mesothelial cells as a baseline for gene expression, a comparison analysis between spontaneous mesotheliomas and mesotheliomas in vinylidene chloride-exposed animals showed that of the 21,901 probesets on the array, the two tumor groups shared 10,372 probesets, while 3,764 probesets were unique to vinylidene chloride-exposed mesotheliomas, and 3,612 probesets were unique to spontaneous mesotheliomas. Of the 10,372 shared probesets, 9,568 were mapped to known genes in the IPA database, and 7,454 were considered analysis ready according to IPA based on a threshold of  $P < 0.001$  and filtering for duplicates. IPA core analysis was used to correlate the 7,454 probesets with relevant biological functions. Biological functions representative of the top up- and downregulated genes in both tumor groups included cellular development, cell and tissue morphology, organismal injury, embryonic development, organ and tissue development, inflammatory response, cellular growth and proliferation, DNA replication, recombination, and repair and cell cycle regulation, with many of the probesets showing overlapping biological functions in multiple categories (Figure L2).

Results of comparison analyses showed that mesotheliomas from control and vinylidene chloride-exposed animals share similarities in expression of many genes associated with tumorigenesis. Mesotheliomas from control and vinylidene chloride-exposed animals shared overrepresentation of genes associated with the biological functions of inflammatory response, cell/organismal injury, embryonic development, tissue and organ development, DNA

replication, recombination, and repair, and cell cycle regulation. The probesets associated with these biologic functions often showed overlap with multiple categories of biologic functions associated with the above processes. There was similar expression of several oncogenes, growth factors, cell cycle regulators, embryonic genes, cell survival genes, and solute carrier molecules between spontaneous and vinylidene chloride-exposed mesotheliomas (Table L2).

Mesotheliomas from vinylidene chloride-exposed animals are differentiated from spontaneous tumors based on gene expression indicative of a proinflammatory and immune dysfunction response. In both spontaneous and vinylidene chloride-exposed mesotheliomas, there was significant overlap of pathways involving genes associated with cell growth and tissue remodeling (*Tgfb2*, *Tgfb1*, *Vegfc*, *Fgfr2*, *Igf1*, *Igf1p*), cell cycle regulators (*Cdkn1a*, *Cdkn1b*), oncogenes and proto-oncogenes (*Maib*, *Fos*, *Junb*, *Lyn*), Ras-Mapk pathway mediators (*Rasd1*, *Rnd*, *Prkcb*, *Mapk12*), tumor suppressor genes (*Tp53*, *Lats2*), adhesion molecules (*Epcam*, *Cdh22*, *Ctnnb1*, *Igfb2*), apoptosis genes (*Gadd45b*, *Bcl2a1*), developmental genes (*Plac8*, *Wnt4*, *Plau*, *Gata5*), transporters and solute carriers (*Slc7*, *Slc28*, *Abc*), mesothelial cell markers (*Krt18/19*, *Des*) and genes associated with oxidative stress (*Duox*, *Gpx2*), compared to Fred-PE cells ( $P < 0.001$ ) (Table L2). However, in mesotheliomas from vinylidene chloride-exposed animals, there was significant differential expression of pathways associated with inflammatory and immune response genes such as chemokines (*Ccl5/6/11/27*, *Cxcl9/11*), cytokines and cytokine receptors (*Il1b*, *Il10/18/24/34*, *Il6r*, *Il7r*, *Il1rn*, *Tnfrsf11b*, *Cd40*), Jak/Stat mediators (*Stat1/2*, *Jak2*), Complement factors (*Cfh*, *Clqa/b*, *Serp1g1*), Pattern recognition receptors (*Tlr2/7/8*, *Mrc1*), Interferon pathway mediators (*Ifngr1*, *Irf9*, *Irf5*, *Ifitm1*), activated macrophage products (*Chi3l1*, *Sparcl1*, *C1qb*, *C1qa*, *S100a8*, *S100a9*), cell surface receptors (*S1pr1*, *Fcer*, *Fcgr*, *Stab1*, *Cd163*, *Cd68*, *Cd53*, *Cd36*, *Clec*), and a variety of inflammatory mediators (*Aif1*, *Ptgds1/2*, *Lyz2*, *Mcpt10*, *Tdo2*, *Ubd*, *Ddx60*, *Cybb*, *Pla2g2a*, *Lyve1*) compared to spontaneous mesotheliomas ( $P < 0.001$ ) (Table L3). There was a more prominent overrepresentation of genes associated with a proinflammatory response in mesotheliomas from vinylidene chloride-exposed animals, including higher upregulation of proinflammatory chemokines (*Ccl5*, *Ccl6*, *Cxcl9*) and decreased expression of anti-inflammatory cytokines (*Il10*, *Il18*, *Il24*). Pathways containing genes associated with increased tissue damage (*Tlr2*, *Dpt*, *Mrc1*, *Pla2g2a*) were differentially expressed in vinylidene chloride-exposed mesotheliomas, and genes in Damage-Associated Molecular Pattern (DAMP) molecule pathways (*S100a8*, *S100a9*, *Mrc1* and *Lyve1*), were overrepresented in vinylidene chloride-exposed mesotheliomas compared to spontaneous mesotheliomas (Table L3). Select genes from these pathways were validated by qPCR (Table L4).

## DISCUSSION

Comparison of global gene expression profiling of mesotheliomas arising in male F344/N rats exposed to vinylidene chloride, spontaneous mesotheliomas in F344/N rats, and cultured rat mesothelial cells (Fred-PE cells) was performed in order to characterize the molecular features of these tumors and elucidate their chemical-specific gene expression profiles. Global gene expression profiling enabled the separation of these tumors based on their transcriptomic profiles, despite an indistinguishable morphologic difference between spontaneous and vinylidene chloride-exposed mesotheliomas. Similarities between spontaneous mesotheliomas and those from vinylidene chloride-exposed animals primarily involved genes and pathways associated with the tumorigenic response and tissue remodeling. For example, in terms of growth factors, there was consistent representation of the *Tgf-beta* and *Igf* pathways in mesotheliomas from vinylidene chloride-exposed and control rats; these pathways are important in tissue remodeling of many organs during disease and tumorigenesis, including mesothelioma (Garlepp, 1995) (Table L2). However, differences in common pathways between tumors from control and vinylidene chloride-exposed animals were often noted; for example, dermatopontin (*Dpt*), which is known to interact with *Tgfb* to enhance its biologic activity (Okomoto, 1999), was markedly upregulated in mesotheliomas from vinylidene chloride-exposed animals compared to controls (Table L4). Based on differentially expressed pathways, vinylidene chloride-exposed mesotheliomas were distinguished from spontaneous mesotheliomas by overrepresentation of genes associated with a proinflammatory response and immune dysregulation, including alterations in the expression of proinflammatory chemokines and cytokines, cytokine receptors, complement components, Jak/Stat mediators, DAMP molecules, pattern recognition receptors, and other inflammatory mediators associated with tissue damage. While the exact effects of vinylidene chloride on mesothelial cells are not known, the increased incidence of mesotheliomas in the study resulting from vinylidene chloride exposure suggests that long-term exposure to vinylidene chloride directly or indirectly affects mesothelial cell function. It has been shown that exposure to vinylidene chloride results in saturation of the glutathione pathway and the generation of reactive vinylidene chloride metabolites (1,1-diethylene oxide, chloroacetyl chloride), which have potential to cause tissue damage

(Hathway, 1977). Inflammation is also a well-known contributor to mesotheliomagenesis (Hanahan and Weinberg, 2000, 2011; Colotta *et al.*, 2009), consistent with the overrepresentation of genes associated with immune dysregulation, inflammation, and tissue damage observed in this study associated with vinylidene chloride-exposed mesotheliomas. Direct damage to mesothelial cells from inflammation or reactive metabolites can lead to cell proliferation and/or innate immune response activation. Anti-inflammatory cytokines and chemokines were underrepresented in vinylidene chloride-exposed mesotheliomas compared to spontaneous tumors, while pattern recognition receptors and DAMP molecules were upregulated, consistent with immune dysregulation and a proinflammatory response. Responses such as these have been associated with mesothelial cell proliferation (Mutsaers *et al.*, 1997). DAMP molecule pathways contain molecules that initiate and perpetuate inflammatory responses in noninfectious diseases, including recognition of components released during cell injury. Pattern recognition receptors are expressed by innate immune cells and function to identify molecules associated with microbial pathogens, cellular stress, or DAMP molecule pathways. The overrepresentation of these complex pathways supports the observation of a proinflammatory environment associated with mesotheliomas in vinylidene chloride-exposed animals.

Key differences in differential gene expression observed between spontaneous mesotheliomas and mesotheliomas occurring in vinylidene chloride-exposed animals differentiates these tumors from each other based on their global transcriptomic profiles, despite indistinguishable morphology. Furthermore, these data provide important mechanistic information regarding genomic alterations associated with chemical exposure. These genomic studies provide a better understanding of mechanisms of mesotheliomagenesis due to vinylidene chloride exposure in the F344/N rat.

## REFERENCES

- Colotta, F., Allavena, P., Sica, A., Garlanda, C., and Mantovani, A. (2009). Cancer-related inflammation, the seventh hallmark of cancer: Links to genetic instability. *Carcinogenesis* **30**, 1073-1081.
- Crosby, L.M., Hyder, K.S., DeAngelo, A.B., Kepler, T.B., Gaskill, B., Benavides, G.R., Yoon, L., and Morgan, K. T. (2000). Morphologic analysis correlates with gene expression changes in cultured F344 rat mesothelial cells. *Toxicol. Appl. Pharmacol.* **169**, 205-221.
- Garlepp, M.J., and Leong, C.C. (1995). Biologic and immunologic aspects of malignant mesothelioma. *Eur. Respir. J.* **4**, 643-650.
- Gautier, L., Cope, L., Bolstad, B.M., and Irizarry, R.A. (2004). Affy-analysis of Affymetrix GeneChip data at the probe level. *Bioinformatics* **20**, 307-315.
- Guo, W., Sarkar, S.K., and Peddada, S.D. (2010). Controlling false discoveries in multidimensional directional decisions, with applications to gene expression data on ordered categories. *Biometrics* **66**, 485-492.
- Hanahan, D., and Weinberg, R.A. (2000). The hallmarks of cancer. *Cell* **100**, 57-70.
- Hanahan, D., and Weinberg, R.A. (2011). Hallmarks of cancer: The next generation. *Cell* **144**, 646-674.
- Hathway, D.E. (1977). Comparative mammalian metabolism of vinyl chloride and vinylidene chloride in relation to oncogenic potential. *Environ. Health Perspect.* **21**, 55-59.
- Irizarry, R.A., Bolstad, B.M., Collin, F., Cope, L.M., Hobbs, B., and Speed, T.P. (2003). Summaries of Affymetrix GeneChip probe level data. *Nucleic Acids Res.* **31**, e15.
- Kim, Y., Ton, T.V., DeAngelo, A.B., Morgan, K., Devereux, T.R., Anna, C., Collins, J.B., Paules, R.S., Crosby, L.M., and Sills, R.C. (2006). Major carcinogenic pathways identified by gene expression analysis of peritoneal mesotheliomas following chemical treatment in F344 rats. *Toxicol. Appl. Pharmacol.* **214**, 144-151.

Mutsaers, S.E., McAnulty, R.J., Laurent, G.J., Versnel, M.A., Whitaker, D., and Papadimitriou, J.M. (1997). Cytokine regulation of mesothelial cell proliferation in vitro and in vivo. *Eur. J. Cell Biol.* **72**, 24-29.

National Toxicology Program (NTP) (1996). Toxicology and Carcinogenesis Studies of Codeine (CAS No. 76-57-3) in F344/N Rats and B6C3F<sub>1</sub> Mice (Feed Studies). Technical Report Series No. 455. NIH Publication No. 96-3360. U.S. Department of Health and Human Services, Public Health Service, National Institutes of Health, Research Triangle Park, NC.

National Toxicology Program (NTP) (2003). Toxicology and Carcinogenesis Studies of Riddelliine (CAS No. 23246-96-0) in F344/N Rats and B6C3F<sub>1</sub> Mice (Gavage Studies). Technical Report Series No. 508. NIH Publication No. 03-4442. U.S. Department of Health and Human Services, Public Health Service, National Institutes of Health, Research Triangle Park, NC.

National Toxicology Program (NTP) (2013). Toxicology Studies of Cobalt Metal (CAS No. 7440-48-4) in F344/N Rats and B6C3F<sub>1</sub> Mice and Toxicology and Carcinogenesis Studies of Cobalt Metal in F344/NTac Rats and B6C3F<sub>1</sub>/N Mice (Inhalation Studies). Technical Report Series No. 581. NIH Publication No. 14-5923. National Institutes of Health, Research Triangle Park, NC., Public Health Service, U.S. Department of Health and Human Services (in preparation).

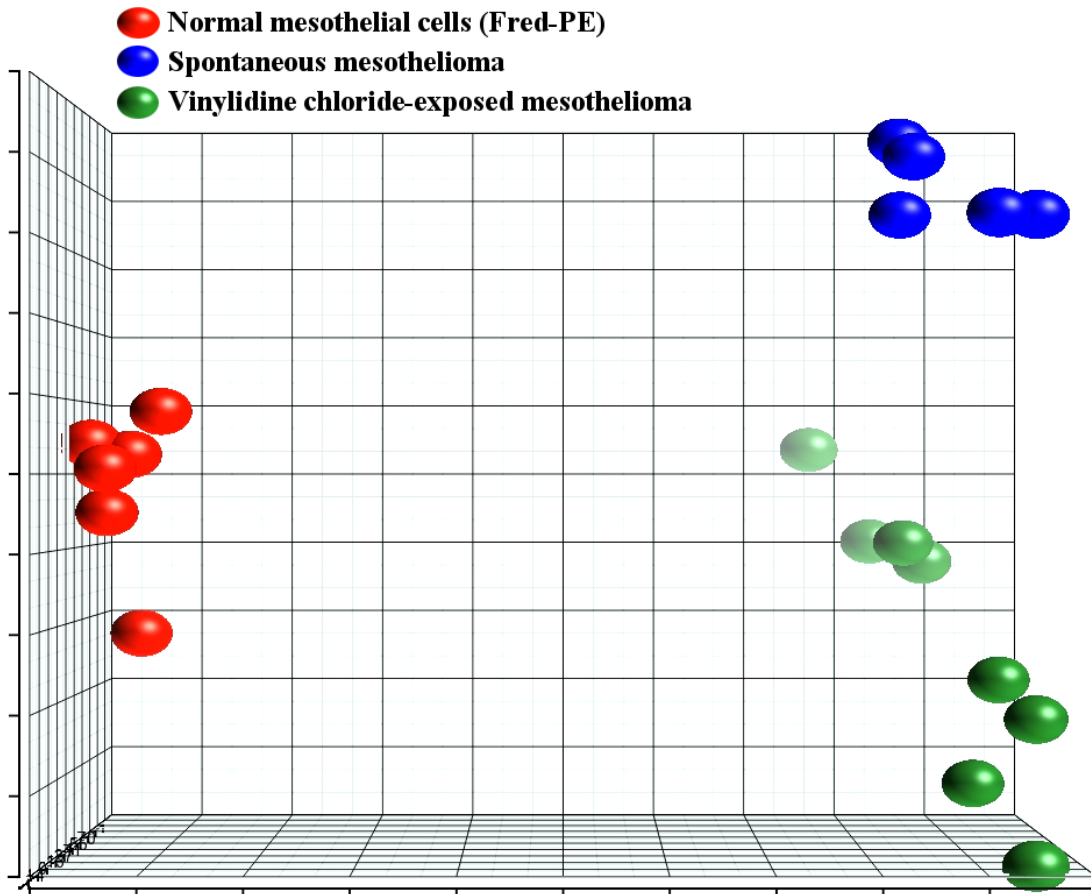
Okamoto, O., Fujiwara, S., Abe, M., and Sato, Y. (1999). Dermatopontin interacts with transforming growth factor beta and enhances its biologic activity. *Biochem. J.* **337**, 537-541.

Peddada, S., Harris, S., Zajd, J., and Harvey, E. (2005). ORIOGEN: Order restricted inference for ordered gene expression data. *Bioinformatics* **21**, 3933-3934.

**TABLE L1**  
**Spontaneous and Vinylidene Chloride-Exposed Malignant Mesotheliomas from Male F344/N Rats**  
**Used for Genomic Profiling**

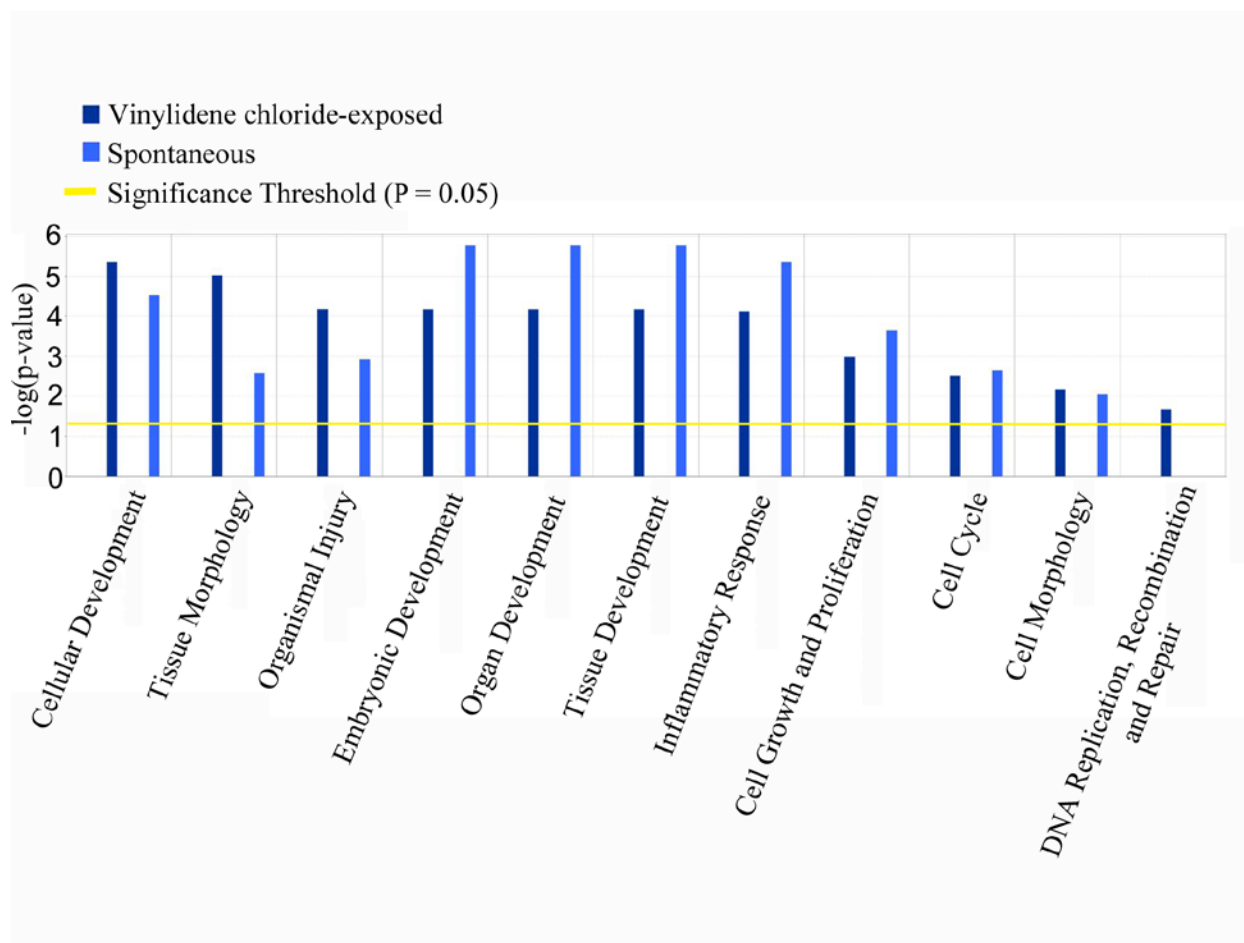
<b>Dose</b>	<b>Study</b>	<b>Animal Number</b>	<b>Frozen ID</b>	<b>Weight (g)</b>	<b>Location</b>
Control	Riddelliine	5	SO2130	0.5200	Peritoneum
Control	Codeine	19	MB194	1.0000	Peritoneum
Control	Cobalt metal	34	BW 4719	1.1050	Peritoneum
Control	Cobalt metal	34	BW 4721	0.5179	Peritoneum
Control	Cobalt metal	34	BW 4723	0.5406	Testes, capsule
50 ppm	Vinylidene chloride	401	BW 2457	0.7086	Peritoneum
50 ppm	Vinylidene chloride	401	BW 2447	0.3128	Mesentery
50 ppm	Vinylidene chloride	402	BW 2304	1.1392	Mesentery
100 ppm	Vinylidene chloride	601	BW 2287	1.2258	Testes, capsule
100 ppm	Vinylidene chloride	613	BW 2353	0.3700	Testes, capsule
100 ppm	Vinylidene chloride	632	BW 2259	0.9484	Testes, capsule
100 ppm	Vinylidene chloride	640	BW 2281	0.9158	Testes, capsule
100 ppm	Vinylidene chloride	646	BW 2276	0.9109	Testes, capsule





**FIGURE L1**  
**Principal Component Analysis Comparing Global Gene Profiles of Fred-PE Mesothelial Cells (red), Spontaneous Mesotheliomas from Control Rats (blue), and Mesotheliomas from Vinylidene Chloride-Exposed Rats (green)**

Principal Component Analysis shows significant intergroup similarities in global gene expression and clear separation of experimental groups in space, indicating significant differences between groups in terms of their global gene expression. Principal component analysis is a multivariate data analysis procedure that linearly transforms the original data set ( $N$  genes  $\times$   $P$  samples) so that each principal component ( $1 \times P$ ) becomes a variable that is a combination of the original variables and is orthogonal to all other principal components. The total variance explained by the principal component analysis is 69.6%. Each axis explains a certain percentage of the variance in the data; the x-axis explains the most variance (52.8%), the y-axis explains the second most variance (11.4%), and the z-axis explains the third most variance (5.4%) between the 19 samples.

**FIGURE L2**

**Comparison Analysis of Spontaneous and Vinylidene Chloride-Exposed Mesothelioma Microarray Datasets**

Illustration of overrepresented biological functions including cellular development, cell and tissue morphology, organismal injury, embryonic development, organ and tissue development, inflammatory response, cellular growth and proliferation, DNA replication, recombination, and repair, and cell cycle regulation

**TABLE L2**  
**Selected Significantly Expressed Pathways in Mesotheliomas from Vinylidene Chloride-Exposed and Control F344/N Rats (P < 0.001) Compared to Fred-PE Cells<sup>a</sup>**

Gene Name	Gene Symbol	Spontaneous	Vinylidene Chloride-Exposed
<b>Growth Factors</b>			
transforming growth factor, beta 2	<i>Tgfb2</i>	-18.77	-18.94
transforming growth factor, beta receptor 1	<i>Tgfb1</i>	2.07	1.80
transforming growth factor, beta-induced, 68kDa	<i>Tgfb1</i>	39.53	48.79
vascular endothelial growth factor C	<i>Vegfc</i>	-7.26	-8.00
fibroblast growth factor receptor 2	<i>Fgfr2</i>	-1.79	-1.53
insulin-like growth factor 1 (somatomedin C)	<i>Igf1</i>	17.04	37.54
insulin-like growth factor 2 binding protein 1	<i>Igf2bp1</i>	-2.80	-2.70
insulin-like growth factor binding protein 6	<i>Igfbp6</i>	9.96	8.42
insulin-like growth factor binding protein 3	<i>Igfbp3</i>	32.46	29.23
<b>Cell Cycle</b>			
cyclin-dependent kinase inhibitor 1A (p21, Cip1)	<i>Cdkn1a</i>	-4.60	-6.67
cyclin-dependent kinase inhibitor 1B (p27, Kip1)	<i>Cdkn1b</i>	-5.68	-4.95
<b>Oncogenes/Protooncogenes</b>			
v-maf musculoaponeurotic fibrosarcoma oncogene homolog B (avian)	<i>Mafb</i>	23.48	26.02
FBJ murine osteosarcoma viral oncogene homolog	<i>Fos</i>	-9.09	-7.02
jun B protooncogene	<i>Junb</i>	-4.51	-6.29
v-yes-1 Yamaguchi sarcoma viral related oncogene homolog	<i>LYN (v-yes)</i>	5.02	5.44
<b>RAS-Mapk Pathway</b>			
RAS, dexamethasone-induced 1	<i>Rasd1</i>	38.52	14.18
Rho family GTPase 1	<i>Rnd1</i>	-13.26	-8.60
Rho family GTPase 3	<i>Rnd3</i>	-11.37	-28.00
protein kinase C, beta	<i>Prkcb</i>	68.52	53.86
mitogen-activated protein kinase 12	<i>Mapk12</i>	5.53	8.21
mitogen-activated protein kinase-activated protein kinase 3	<i>Mapkapk3</i>	15.13	11.95
<b>Tumor Suppressor Genes</b>			
tumor protein p53	<i>Tp53</i>	-2.20	-2.80
large tumor suppressor homologue 2	<i>Lats2</i>	-1.82	-1.87
<b>Adhesion Molecule, Integrins, Catenins</b>			
epithelial cell adhesion molecule	<i>Epcam</i>	21.48	12.63
cadherin 22, type 2	<i>Cdh22</i>	128.56	22.82
catenin (cadherin-associated protein), beta 1, 88kDa	<i>Ctnnb1</i>	-1.41	-2.09
integrin, beta 2 (complement component 3 receptor 3 and 4 subunit)	<i>Igb2</i>	23.11	33.51
<b>Growth Arrest, Apoptosis</b>			
growth arrest and DNA-damage-inducible, beta	<i>Gadd45b</i>	-10.34	-8.88
BCL2-related protein A1	<i>Bcl2A1</i>	14.42	13.86
Fas apoptotic inhibitory molecule 3	<i>Faim3</i>	9.43	17.41
<b>Embryonic/Cell Development (Cell Migration, Differentiation)</b>			
placenta-specific 8	<i>Plac8</i>	44.99	214.04
wingless-type MMTV integration site family, member 4	<i>Wnt4</i>	10.91	6.00
plasminogen activator, urokinase	<i>Plau</i>	18.08	21.11
GATA binding protein 5	<i>Gata5</i>	14.53	7.91

**TABLE L2**  
**Selected Significantly Expressed Pathways in Mesotheliomas from Vinylidene Chloride-Exposed and Control F344/N Rats (P < 0.001) Compared to Fred-PE Cells<sup>a</sup>**

Gene Name	Gene Symbol	Spontaneous	Vinylidene Chloride-Exposed
<b>Adhesion Molecules and Matrix Remodeling Genes</b>			
epithelial cell adhesion molecule	<i>Epcam</i>	21.48	12.63
collagen, type VI, alpha 2	<i>Col6a2</i>	65.56	26.35
collagen, type VI, alpha 1	<i>Col6a1</i>	57.66	35.84
integrin, beta 2 (complement component 3 receptor 3 and 4 subunit)	<i>Itgb2</i>	23.11	33.51
<b>Transporters and Solute Carriers</b>			
solute carrier family 7, member 9	<i>Slc7A9</i>	12.44	9.67
solute carrier family 7, member 7	<i>Slc7A7</i>	14.24	11.70
solute carrier family 28, member 2	<i>Slc28A2</i>	14.32	26.94
ATP-binding cassette, sub-family A (ABC1), member 4	<i>Abca4</i>	33.55	26.82
<b>Mesothelial Cell Markers</b>			
cytokeratin 18	<i>Krt18</i>	145.17	75.19
cytokeratin 19	<i>Krt19</i>	440.67	299.57
thrombomodulin	<i>Thbd</i>	27.52	49.60
desmin	<i>Des</i>	22.17	26.26
<b>Reactive Oxygen Species (ROS)</b>			
dual oxidase 2	<i>Duox2</i>	87.37	44.62
glutathione peroxidase 2 (gastrointestinal)	<i>Gpx2</i>	88.16	68.67

<sup>a</sup> Numeric values expressed are fold changes in gene expression compared to Fred-PE mesothelial cells.

**TABLE L3**  
**Selected Differentially Expressed Genes Associated with Inflammation and Immune Response**  
**in Vinylidene Chloride-Exposed Compared to Spontaneous Mesotheliomas from F344/N Rats (P < 0.001)<sup>a</sup>**

Gene Name	Gene Symbol	Spontaneous	Vinylidene Chloride-Exposed
<b>Chemokines</b>			
chemokine (C-C motif) ligand 11	<i>Ccl11</i>	742.48	457.60
chemokine (C-C motif) ligand 5	<i>Ccl5</i>	18.96	35.64
chemokine (C-C motif) ligand 6	<i>Ccl6</i>	84.54	143.55
chemokine (C-X-C motif) ligand 9	<i>Cxcl9</i>	6.60	24.00
chemokine (C-X-C motif) ligand 11	<i>Cxcl11</i>	6.51	19.09
chemokine (C-C motif) ligand 27	<i>Ccl27</i>	14.62	7.34
<b>Cytokines &amp; Cytokine Receptors</b>			
interleukin 1, beta	<i>Il1b</i>	3.03	2.04
interleukin 18 (interferon-gamma-inducing factor)	<i>Il18</i>	43.53	28.92
interleukin 34	<i>Il34</i>	8.98	5.49
interleukin 6 receptor	<i>Il6r</i>	7.41	6.04
interleukin 7 receptor	<i>Il7r</i>	9.49	9.62
tumor necrosis factor receptor superfamily, member 11b	<i>Tnfrsf11b</i>	42.39	65.71
interleukin 24	<i>Il24</i>	25.54	10.60
interleukin 10	<i>Il10</i>	17.89	11.52
interleukin 1 receptor antagonist	<i>Il1rn</i>	9.97	5.52
CD40 molecule, TNF receptor superfamily member 5	<i>Cd40</i>	9.13	3.01
<b>Jak-Stat Pathway</b>			
signal transducer and activator of transcription 1, 91kDa	<i>Stat1</i>	6.70	6.27
signal transducer and activator of transcription 2, 113kDa	<i>Stat2</i>	3.13	2.25
Janus kinase 2	<i>Jak2</i>	6.37	6.70
<b>Histocompatibility Markers</b>			
CD74 molecule, major histocompatibility complex, class II invariant chain	<i>Cd74</i>	440.54	397.95
<b>Complement</b>			
complement factor H	<i>Cfh</i>	285.38	223.67
complement component 1, q subcomponent, B chain	<i>C1qb</i>	110.85	102.88
complement component 1, q subcomponent, A chain	<i>C1qa</i>	134.53	133.41
serpin peptidase inhibitor, clade G (C1 inhibitor), member 1	<i>Serping1</i>	265.08	289.04
<b>Pattern Recognition Receptors</b>			
toll-like receptor 2	<i>Tlr2</i>	8.27	10.05
toll-like receptor 8	<i>Tlr8</i>	25.66	31.70
toll-like receptor 7	<i>Tlr7</i>	10.69	14.00
mannose receptor, C type 1	<i>Mrc1</i>	78.61	113.03
<b>Interferon Pathway</b>			
interferon gamma receptor 1	<i>Ifngr1</i>	2.28	2.69
interferon regulatory factor 9	<i>Irf9</i>	3.99	2.90
interferon regulatory factor 5	<i>Irf5</i>	2.21	2.08
interferon induced transmembrane protein 1	<i>Ifitm1</i>	20.20	27.50

**TABLE L3**  
**Selected Differentially Expressed Genes Associated with Inflammation and Immune Response**  
**in Vinylidene Chloride-Exposed Compared to Spontaneous Mesotheliomas from F344/N Rats (P < 0.001)**

Gene Name	Gene Symbol	Spontaneous	Vinylidene Chloride-Exposed
<b>Inflammatory Mediators/Enzymes/Miscellaneous</b>			
allograft inflammatory factor 1	<i>AIF1</i>	171.59	115.82
prostaglandin D2 synthase 21kDa	<i>Ptgds</i>	269.98	144.59
prostaglandin-endoperoxide synthase 1 (prostaglandin G/H synthase and cyclooxygenase)	<i>Ptgs1</i>	25.60	23.71
prostaglandin-endoperoxide synthase 2 (prostaglandin G/H synthase and cyclooxygenase)	<i>Ptgs2</i>	-91.03	-58.07
lysozyme 2	<i>lyz2</i>	217.92	209.00
mast cell protease 10	<i>Mcpt10</i>	226.30	68.94
tryptophan 2,3-dioxygenase	<i>Tdo2</i>	218.85	60.50
ubiquitin D	<i>Ubd</i>	173.19	273.96
DEAD (Asp-Glu-Ala-Asp) box polypeptide 60	<i>Ddx60</i>	162.57	163.09
cytochrome b-245, beta polypeptide	<i>Cybb</i>	21.33	30.64
phospholipase A2, group IIA	<i>Pla2g2a</i>	86.13	110.36
lymphatic vessel endothelial hyaluronan receptor 1 ( <i>Lyve1</i> )	<i>Lyve1</i>	86.95	247.67
<b>Activated Macrophage Products</b>			
chitinase 3-like 1	<i>Chi3l1</i>	164.40	29.85
SPARC-like 1 (hevin)	<i>Sparcl1</i>	70.97	147.78
complement component 1, q subcomponent, B chain	<i>C1qb</i>	110.85	102.88
complement component 1, q subcomponent, A chain	<i>C1qa</i>	134.53	133.41
S100 calcium binding protein A8	<i>S100a8</i>	2.72	18.47
S100 calcium binding protein A9	<i>S100a9</i>	4.03	19.22
<b>Cell Surface Markers/Receptors</b>			
sphingosine-1-phosphate receptor 1	<i>Slpr1</i>	25.58	48.53
Fc fragment of IgG, low affinity IIb, receptor (CD32)	<i>Fcgr2b</i>	195.35	260.51
Fc fragment of IgE, high affinity I, receptor for; alpha polypeptide	<i>Fcer1a</i>	37.75	35.45
Fc fragment of IgE, high affinity I, receptor for; gamma polypeptide	<i>Fcer1g</i>	104.62	93.90
Fc fragment of IgG, low affinity IIIa, receptor (CD16a)	<i>Fcgr3a</i>	54.85	24.69
Stabilin 1	<i>Stab1</i>	55.00	36.21
Fc fragment of IgG, high affinity Ia, receptor (CD64)	<i>Fcgr1a</i>	29.34	29.28
Fc fragment of IgG, low affinity IIa, receptor (CD32)	<i>Fcgr2a</i>	40.81	70.44
CD 163 molecule	<i>Cd163</i>	46.67	132.34
CD 68 molecule	<i>Cd68</i>	29.39	34.57
CD 53 molecule	<i>Cd53</i>	137.22	139.78
C-type lectin domain family 4, member a3	<i>Clec4a3</i>	92.10	73.27
C-type lectin domain family 10, member A	<i>Clec10a</i>	48.13	54.25
C-type lectin domain family 4, member A	<i>Clec4a</i>	35.29	32.59
C-type lectin domain family 7, member A	<i>Clec7a</i>	29.12	22.76
CD36 molecule (thrombospondin receptor)	<i>Cd36</i>	139.68	236.34

<sup>a</sup> Numeric values expressed are fold changes in gene expression compared to Fred-PE mesothelial cells.

**TABLE L4**  
**Quantitative PCR (qPCR) Validation of Gene Expression Changes on Microarray**  
**of Spontaneous and Vinylidene Chloride-Exposed Mesotheliomas in F344/N Rats<sup>a</sup>**

Gene Name	Gene Symbol	Spontaneous		Vinylidene Chloride-Exposed	
		Microarray	qPCR	Microarray	qPCR
Cytokeratin 18	<i>Krt18</i>	162.94	1,079.19	75.19	473.86
Epithelial adhesion molecule	<i>Epcam</i>	21.48	481.96	12.63	860.43
Cyclin dependent kinase 1a (p21)	<i>Cdkn1a</i>	-4.6	-2.88	-6.67	-3.97
Fatty acid binding protein 4	<i>Fabp4</i>	72.71	2,705.77	251.32	12,796.5
Placenta-specific 8	<i>Plac8</i>	44.99	16,744.15	214.04	25,150.22
Synuclein, gamma	<i>Sncg</i>	9.53	745.92	25.59	3,094.01
Dermatopontin	<i>Dpt</i>	14.73	2,397.67	57.77	13,203.71
Tumor protein p53	<i>Tp53</i>	-2.2	-1.11	-2.8	-1.67

<sup>a</sup> Values are fold change in gene expression compared to Fred-PE cells.