



NTP

National Toxicology Program

U.S. Department of Health and Human Services

NTP TECHNICAL REPORT ON
THE TOXICOLOGY AND
CARCINOGENESIS STUDIES OF
NAPHTHALENE
(CAS No. 91-20-3)
IN F344/N RATS
(INHALATION STUDIES)

NTP TR 500

DECEMBER 2000

NTP TECHNICAL REPORT
ON THE
TOXICOLOGY AND CARCINOGENESIS
STUDIES OF NAPHTHALENE
(CAS NO. 91-20-3)
IN F344/N RATS
(INHALATION STUDIES)

NATIONAL TOXICOLOGY PROGRAM
P.O. Box 12233
Research Triangle Park, NC 27709

December 2000

NTP TR 500

NIH Publication No. 01-4434

U.S. DEPARTMENT OF HEALTH AND HUMAN SERVICES
Public Health Service
National Institutes of Health

FOREWORD

The National Toxicology Program (NTP) is made up of four charter agencies of the U.S. Department of Health and Human Services (DHHS): the National Cancer Institute (NCI), National Institutes of Health; the National Institute of Environmental Health Sciences (NIEHS), National Institutes of Health; the National Center for Toxicological Research (NCTR), Food and Drug Administration; and the National Institute for Occupational Safety and Health (NIOSH), Centers for Disease Control and Prevention. In July 1981, the Carcinogenesis Bioassay Testing Program, NCI, was transferred to the NIEHS. The NTP coordinates the relevant programs, staff, and resources from these Public Health Service agencies relating to basic and applied research and to biological assay development and validation.

The NTP develops, evaluates, and disseminates scientific information about potentially toxic and hazardous chemicals. This knowledge is used for protecting the health of the American people and for the primary prevention of disease.

The studies described in this Technical Report were performed under the direction of the NIEHS and were conducted in compliance with NTP laboratory health and safety requirements and must meet or exceed all applicable federal, state, and local health and safety regulations. Animal care and use were in accordance with the Public Health Service Policy on Humane Care and Use of Animals. The prechronic and chronic studies were conducted in compliance with Food and Drug Administration (FDA) Good Laboratory Practice Regulations, and all aspects of the chronic studies were subjected to retrospective quality assurance audits before being presented for public review.

These studies are designed and conducted to characterize and evaluate the toxicologic potential, including carcinogenic activity, of selected chemicals in laboratory animals (usually two species, rats and mice). Chemicals selected for NTP toxicology and carcinogenesis studies are chosen primarily on the bases of human exposure, level of production, and chemical structure. The interpretive conclusions presented in this Technical Report are based only on the results of these NTP studies. Extrapolation of these results to other species and quantitative risk analyses for humans require wider analyses beyond the purview of these studies. Selection *per se* is not an indicator of a chemical's carcinogenic potential.

Details about ongoing and completed NTP studies are available at the NTP's World Wide Web site: <http://ntp-server.niehs.nih.gov>. Abstracts of all NTP Technical Reports and full versions of the most recent reports and other publications are available from the NIEHS' Environmental Health Information Service (EHIS) <http://ehis.niehs.nih.gov> (800-315-3010 or 919-541-3841). In addition, printed copies of these reports are available from EHIS as supplies last. A listing of all the NTP reports printed since 1982 appears on the inside back cover.

NTP TECHNICAL REPORT
ON THE
TOXICOLOGY AND CARCINOGENESIS
STUDIES OF NAPHTHALENE
(CAS NO. 91-20-3)
IN F344/N RATS
(INHALATION STUDIES)

NATIONAL TOXICOLOGY PROGRAM
P.O. Box 12233
Research Triangle Park, NC 27709

December 2000

NTP TR 500

NIH Publication No. 01-4434

U.S. DEPARTMENT OF HEALTH AND HUMAN SERVICES
Public Health Service
National Institutes of Health

CONTRIBUTORS

National Toxicology Program

Evaluated and interpreted results and reported findings

K.M. Abdo, Ph.D., Study Scientist
 D.W. Bristol, Ph.D.
 J.R. Bucher, Ph.D.
 R.E. Chapin, Ph.D.
 J.R. Hailey, D.V.M.
 J.K. Haseman, Ph.D.
 R.A. Herbert, D.V.M., Ph.D.
 R.R. Maronpot, D.V.M.
 R.L. Melnick, Ph.D.
 D.P. Orzech, M.S.
 G.N. Rao, D.V.M., Ph.D.
 J.H. Roycroft, Ph.D.
 C.S. Smith, Ph.D.
 G.S. Travlos, D.V.M.
 B.A.T. Willems, Ph.D.
 K.L. Witt, M.S., Integrated Laboratory Systems, Inc.

Battelle Toxicology Northwest

Conducted studies and evaluated pathology findings

B.J. Chou, D.V.M., Ph.D., Principal Investigator
 S.L. Grumbein, D.V.M., Ph.D.
 R.J. Weigle, Ph.D.
 R.B. Westerberg, Ph.D.

Experimental Pathology Laboratories, Inc.

Provided pathology quality assurance

J.F. Hardisty, D.V.M., Principal Investigator
 C.C. Shackelford, D.V.M., M.S., Ph.D.

Dynamac Corporation

Prepared quality assurance audits

S. Brecher, Ph.D., Principal Investigator

NTP Pathology Working Group

*Evaluated slides and prepared pathology report on rats
 (7 October 1999)*

P.K. Hildebrandt, D.V.M., Chairperson
 PATHCO, Inc.
 S.L. Grumbein, D.V.M., Ph.D.
 Battelle Toxicology Northwest
 B.F. Hamilton, D.V.M., Ph.D.
 Glaxo Wellcome, Inc.
 R.A. Herbert, D.V.M., Ph.D.
 National Toxicology Program
 J. Mahler, D.V.M.
 National Toxicology Program
 A. Nyska, D.V.M.
 National Toxicology Program
 C.C. Shackelford, D.V.M., M.S., Ph.D.
 Experimental Pathology Laboratories, Inc.
 R.C. Sills, D.V.M., Ph.D.
 National Toxicology Program
 H. Wall, D.V.M., Ph.D.
 Glaxo Wellcome, Inc.

Analytical Sciences, Inc.

Provided statistical analyses

R.W. Morris, M.S., Principal Investigator
 L.J. Betz, M.S.
 K.P. McGowan, M.B.A.
 J.T. Scott, M.S.

Biotechnical Services, Inc.

Prepared Technical Report

S.R. Gunnels, M.A., Principal Investigator
 L.M. Harper, B.S.
 D.C. Serbus, Ph.D.
 W.D. Sharp, B.A., B.S.
 R.A. Willis, B.A., B.S.

CONTENTS

ABSTRACT	5
EXPLANATION OF LEVELS OF EVIDENCE OF CARCINOGENIC ACTIVITY	8
TECHNICAL REPORTS REVIEW SUBCOMMITTEE	9
SUMMARY OF TECHNICAL REPORTS REVIEW SUBCOMMITTEE COMMENTS	10
INTRODUCTION	13
MATERIALS AND METHODS	23
RESULTS	31
DISCUSSION AND CONCLUSIONS	41
REFERENCES	45
APPENDIX A Summary of Lesions in Male Rats in the 2-Year Inhalation Study of Naphthalene	55
APPENDIX B Summary of Lesions in Female Rats in the 2-Year Inhalation Study of Naphthalene	95
APPENDIX C Genetic Toxicology	125
APPENDIX D Toxicokinetic Results and Model	135
APPENDIX E Chemical Characterization and Generation of Chamber Concentrations	155
APPENDIX F Ingredients, Nutrient Composition, and Contaminant Levels in NTP-2000 Rat and Mouse Ration	165
APPENDIX G Sentinel Animal Program	169

ABSTRACT

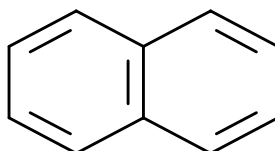

NAPHTHALENE

CAS No. 91-20-3

Chemical Formula: C₁₀H₈ Molecular Weight: 128.18

Synonyms: Mothballs; moth flakes; naphthalin; naphthaline; naphthene; tar camphor; white tar

Trade names: Albocarbon, Dezodorator, Mighty 150, Mighty RD1

Naphthalene is used as an intermediate in the synthesis of phthalic and anthranilic acids, naphthols, naphthylamines, sulfonic acid, synthetic resins, celluloid, and hydronaphthalenes; it is also used in the preparation of anthraquinone, indigo, salicylic acid, and 1-naphthyl-N-methylcarbamate insecticide. It is an ingredient in some moth repellants and toilet bowl deodorants; it is also used in veterinary medicine in antiseptics for irrigating animal wounds and as an external medication to control lice on livestock and poultry. Naphthalene was selected for study by the National Toxicology Program because previous inhalation studies with naphthalene in mice were positive and existing studies in rats were either considered inadequate or were conducted via routes other than inhalation. Male and female F344/N rats were exposed to naphthalene (greater than 99% pure) by inhalation for 2 years. Genetic toxicology studies were conducted in *Salmonella typhimurium* and cultured Chinese hamster ovary cells.

2-YEAR STUDY

Groups of 49 male and 49 female rats were exposed to naphthalene by inhalation at concentrations of 0, 10, 30, or 60 ppm for 6 hours plus T₉₀ (12 minutes) per day, 5 days per week for 105 weeks. Additional groups of nine male and nine female rats were exposed to 10,

30, or 60 ppm for up to 18 months for evaluation of toxicokinetic parameters.

Survival, Body Weights, and Gross Observations

The survival of all exposed groups of male and female rats was similar to that of the chamber controls. Mean body weights of all exposed groups of males were less than those of the chamber control group throughout most of the study. Masses were observed in the nose of male and female rats. These masses frequently partially occluded the nasal passages or obliterated the normal architecture of the nasal turbinates.

Pathology Findings

The incidences of neuroblastoma of the olfactory epithelium, a rare neoplasm, occurred with positive trends in males and females. Because this neoplasm did not occur in chamber control rats or in male rats exposed to 10 ppm and because this neoplasm has not been seen in the historical chamber control rats in NTP 2-year inhalation studies, the increased incidences of neuroblastoma were considered to be related to naphthalene exposure. In males, the incidences of adenoma of the respiratory epithelium of the nose, another rare neoplasm, occurred with a positive trend and were significantly increased in all exposed groups; none occurred in the chamber controls. In females,

these neoplasms occurred in the 30 and 60 ppm groups but not in the chamber control or 10 ppm groups. Because these neoplasms did not occur in the chamber controls and have not been observed in the historical chamber control rats in NTP 2-year inhalation studies, the incidences of nasal adenoma were considered to be related to naphthalene exposure.

Increased incidences of nonneoplastic lesions of the nose associated with exposure to naphthalene included atypical hyperplasia, atrophy, chronic inflammation, and hyaline degeneration of the olfactory epithelium; hyperplasia, squamous metaplasia, hyaline degeneration, and goblet cell hyperplasia of the respiratory epithelium; and glandular hyperplasia and squamous metaplasia.

Toxicokinetic Results Model

A physiologically based toxicokinetic model was developed to characterize the disposition of inhaled naphthalene in rats. Because of its low vapor pressure and high blood-to-air partition coefficient, essentially all of the naphthalene that is absorbed into the general circulation is metabolized. At the exposure concentrations used in the 2-year study, approximately 20% to 30% of the inhaled dose was metabolized by male and female rats. Naphthalene that was not absorbed during exposure was assumed to be exhaled. The respective estimated daily doses metabolized by rats exposed to

10, 30, or 60 ppm for 6 hours (i.e., the internalized doses) are 3.6, 10.7, and 20.1 mg naphthalene/kg body weight for males and 3.9, 11.4, and 20.6 mg/kg for females.

GENETIC TOXICOLOGY

Naphthalene was not mutagenic in any of four strains of *Salmonella typhimurium* with or without induced liver S9 enzymes. However, in cytogenetic tests with cultured Chinese hamster ovary cells, naphthalene induced significant increases in sister chromatid exchanges with and without metabolic activation (S9) and in chromosomal aberrations with S9. Naphthalene did not induce chromosomal aberrations in the absence of S9 activation.

CONCLUSIONS

Under the conditions of this 2-year inhalation study, there was *clear evidence of carcinogenic activity** of naphthalene in male and female F344/N rats based on increased incidences of respiratory epithelial adenoma and olfactory epithelial neuroblastoma of the nose.

In male and female rats, exposure to naphthalene caused significant increases in the incidences of non-neoplastic lesions of the nose.

* Explanation of Levels of Evidence of Carcinogenic Activity is on page 8. A summary of the Technical Reports Review Subcommittee comments and the public discussion on this Technical Report appears on page 10.

Summary of the 2-Year Carcinogenesis and Genetic Toxicology Studies of Naphthalene

	Male F344/N Rats	Female F344/N Rats
Concentrations in air	Chamber control, 10, 30, or 60 ppm	Chamber control, 10, 30, or 60 ppm
Body weights	Exposed groups less than the chamber control group	Exposed groups similar to the chamber control group
Survival rates	24/49, 22/49, 23/48, 21/49	28/49, 21/49, 28/49, 24/49
Nonneoplastic effects	<u>Nose:</u> olfactory epithelium, hyperplasia, atypical (0/49, 48/49, 45/48, 46/48); olfactory epithelium, atrophy (3/49, 49/49, 48/48, 47/48); olfactory epithelium, inflammation, chronic (0/49, 49/49, 48/48, 48/48); olfactory epithelium, degeneration, hyaline (3/49, 46/49, 40/48, 38/48); respiratory epithelium, hyperplasia (3/49, 21/49, 29/48, 29/48); respiratory epithelium, metaplasia, squamous (0/49, 15/49, 23/48, 18/48); respiratory epithelium, degeneration, hyaline (0/49, 20/49, 19/48, 19/48); respiratory epithelium, hyperplasia, goblet cell (0/49, 25/49, 29/48, 26/48); glands, hyperplasia (1/49, 49/49, 48/48, 48/48); glands, metaplasia, squamous (0/49, 3/49, 14/48, 26/48)	<u>Nose:</u> olfactory epithelium, hyperplasia, atypical (0/49, 48/49, 48/49, 43/49); olfactory epithelium, atrophy (0/49, 49/49, 49/49, 47/49); olfactory epithelium, inflammation, chronic (0/49, 47/49, 47/49, 45/49); olfactory epithelium, degeneration, hyaline (13/49, 46/49, 49/49, 45/49); respiratory epithelium, hyperplasia (0/49, 18/49, 22/49, 23/49); respiratory epithelium, metaplasia, squamous (0/49, 21/49, 17/49, 15/49); respiratory epithelium, degeneration, hyaline (8/49, 33/49, 34/49, 28/49); respiratory epithelium, hyperplasia, goblet cell (0/49, 16/49, 29/49, 20/49); glands, hyperplasia (0/49, 48/49, 48/49, 42/49); glands, metaplasia, squamous (0/49, 2/49, 20/49, 20/49)
Neoplastic effects	<u>Nose:</u> respiratory epithelium, adenoma (0/49, 6/49, 8/48, 15/48); olfactory epithelium, neuroblastoma (0/49, 0/49, 4/48, 3/48)	<u>Nose:</u> respiratory epithelium, adenoma (0/49, 0/49, 4/49, 2/49); olfactory epithelium, neuroblastoma (0/49, 2/49, 3/49, 12/49)
Level of evidence of carcinogenic activity	Clear evidence	Clear evidence
Genetic toxicology		
<i>Salmonella typhimurium</i> gene mutations:	Negative in strains TA98, TA100, TA1535, and TA1537 with and without S9	
Sister chromatid exchanges		
Cultured Chinese hamster ovary cells <i>in vitro</i> :	Positive with and without S9	
Chromosomal aberrations		
Cultured Chinese hamster ovary cells <i>in vitro</i> :	Positive with S9, negative without S9	

EXPLANATION OF LEVELS OF EVIDENCE OF CARCINOGENIC ACTIVITY

The National Toxicology Program describes the results of individual experiments on a chemical agent and notes the strength of the evidence for conclusions regarding each study. Negative results, in which the study animals do not have a greater incidence of neoplasia than control animals, do not necessarily mean that a chemical is not a carcinogen, inasmuch as the experiments are conducted under a limited set of conditions. Positive results demonstrate that a chemical is carcinogenic for laboratory animals under the conditions of the study and indicate that exposure to the chemical has the potential for hazard to humans. Other organizations, such as the International Agency for Research on Cancer, assign a strength of evidence for conclusions based on an examination of all available evidence, including animal studies such as those conducted by the NTP, epidemiologic studies, and estimates of exposure. Thus, the actual determination of risk to humans from chemicals found to be carcinogenic in laboratory animals requires a wider analysis that extends beyond the purview of these studies.

Five categories of evidence of carcinogenic activity are used in the Technical Report series to summarize the strength of the evidence observed in each experiment: two categories for positive results (**clear evidence** and **some evidence**); one category for uncertain findings (**equivocal evidence**); one category for no observable effects (**no evidence**); and one category for experiments that cannot be evaluated because of major flaws (**inadequate study**). These categories of interpretative conclusions were first adopted in June 1983 and then revised in March 1986 for use in the Technical Report series to incorporate more specifically the concept of actual weight of evidence of carcinogenic activity. For each separate experiment (male rats, female rats, male mice, female mice), one of the following five categories is selected to describe the findings. These categories refer to the strength of the experimental evidence and not to potency or mechanism.

- **Clear evidence** of carcinogenic activity is demonstrated by studies that are interpreted as showing a dose-related (i) increase of malignant neoplasms, (ii) increase of a combination of malignant and benign neoplasms, or (iii) marked increase of benign neoplasms if there is an indication from this or other studies of the ability of such tumors to progress to malignancy.
- **Some evidence** of carcinogenic activity is demonstrated by studies that are interpreted as showing a chemical-related increased incidence of neoplasms (malignant, benign, or combined) in which the strength of the response is less than that required for clear evidence.
- **Equivocal evidence** of carcinogenic activity is demonstrated by studies that are interpreted as showing a marginal increase of neoplasms that may be chemical related.
- **No evidence** of carcinogenic activity is demonstrated by studies that are interpreted as showing no chemical-related increases in malignant or benign neoplasms.
- **Inadequate study** of carcinogenic activity is demonstrated by studies that, because of major qualitative or quantitative limitations, cannot be interpreted as valid for showing either the presence or absence of carcinogenic activity.

When a conclusion statement for a particular experiment is selected, consideration must be given to key factors that would extend the actual boundary of an individual category of evidence. Such consideration should allow for incorporation of scientific experience and current understanding of long-term carcinogenesis studies in laboratory animals, especially for those evaluations that may be on the borderline between two adjacent levels. These considerations should include:

- adequacy of the experimental design and conduct;
- occurrence of common versus uncommon neoplasia;
- progression (or lack thereof) from benign to malignant neoplasia as well as from preneoplastic to neoplastic lesions;
- some benign neoplasms have the capacity to regress but others (of the same morphologic type) progress. At present, it is impossible to identify the difference. Therefore, where progression is known to be a possibility, the most prudent course is to assume that benign neoplasms of those types have the potential to become malignant;
- combining benign and malignant tumor incidence known or thought to represent stages of progression in the same organ or tissue;
- latency in tumor induction;
- multiplicity in site-specific neoplasia;
- metastases;
- supporting information from proliferative lesions (hyperplasia) in the same site of neoplasia or in other experiments (same lesion in another sex or species);
- presence or absence of dose relationships;
- statistical significance of the observed tumor increase;
- concurrent control tumor incidence as well as the historical control rate and variability for a specific neoplasm;
- survival-adjusted analyses and false positive or false negative concerns;
- structure-activity correlations; and
- in some cases, genetic toxicology.

**NATIONAL TOXICOLOGY PROGRAM BOARD OF SCIENTIFIC COUNSELORS
TECHNICAL REPORTS REVIEW SUBCOMMITTEE**

The members of the Technical Reports Review Subcommittee who evaluated the draft NTP Technical Report on naphthalene on 18 May 2000 are listed below. Subcommittee members serve as independent scientists, not as representatives of any institution, company, or governmental agency. In this capacity, subcommittee members have five major responsibilities in reviewing the NTP studies:

- to ascertain that all relevant literature data have been adequately cited and interpreted,
- to determine if the design and conditions of the NTP studies were appropriate,
- to ensure that the Technical Report presents the experimental results and conclusions fully and clearly,
- to judge the significance of the experimental results by scientific criteria, and
- to assess the evaluation of the evidence of carcinogenic activity and other observed toxic responses.

A. John Bailer, Ph.D., Chairperson
Department of Mathematics and Statistics
Miami University
Oxford, OH

James S. Bus, Ph.D.
Health and Environmental Sciences
Dow Chemical Company
Midland, MI

Linda A. Chatman, D.V.M.
Pfizer, Inc.
Groton, CT

John M. Cullen, Ph.D., V.M.D., Principal Reviewer
Department of Microbiology, Parasitology, and Pathology
College of Veterinary Medicine
North Carolina State University
Raleigh, NC

Harold Davis, Ph.D.*
Director of Toxicology
Amgen, Inc.
Thousand Oaks, CA

Norman R. Drinkwater, Ph.D.
McArdle Laboratory for Cancer Research
University of Wisconsin-Madison
Madison, WI

Susan M. Fischer, Ph.D.*
M.D. Anderson Cancer Center
The University of Texas
Smithville, TX

Stephen S. Hecht, Ph.D., Principal Reviewer
University of Minnesota Cancer Centers
Minneapolis, MN

Michele Medinsky, Ph.D., Principal Reviewer
Durham, NC

Jose Russo, M.D.*
Fox Chase Cancer Center
Philadelphia, PA

* Did not attend

SUMMARY OF TECHNICAL REPORTS REVIEW SUBCOMMITTEE COMMENTS

On 18 May 2000, the draft Technical Report on the toxicology and carcinogenesis studies of naphthalene received public review by the National Toxicology Program's Board of Scientific Counselors' Technical Reports Review Subcommittee. The review meeting was held at the National Institute of Environmental Health Sciences, Research Triangle Park, NC.

Dr. K.M. Abdo, NIEHS, introduced the toxicology and carcinogenesis studies of naphthalene by discussing the uses of the chemical and rationale for the study, describing the experimental design, reporting on survival and body weight effects, and commenting on chemical-related neoplasms and nonneoplastic lesions in male and female rats. Dr. Abdo reviewed the 1992 NTP report of a 2-year inhalation study in B6C3F₁ mice which found that naphthalene was carcinogenic in female mice resulting in an increased incidence of alveolar/bronchiolar adenomas. He noted that the Centers for Disease Control and Prevention analyzed urine samples from nearly 1,000 adults for the metabolites of naphthalene, 1-naphthol, and 2-naphthol, and found metabolites in over 80% of the samples, suggesting widespread human exposure. The proposed conclusions for the present 2-year study were *clear evidence of carcinogenic activity* in male and female F344/N rats.

Dr. R.L. Melnick, NIEHS, presented information on toxicokinetic modeling efforts aimed at estimating amounts of naphthalene inhaled by rats and mice at exposure concentrations used in the 2-year studies, amounts metabolized during the 6-hour exposure and 18-hour postexposure periods, steady-state concentrations of naphthalene in the lung and liver during exposure, and rates of metabolism in the lung and liver at steady state. Also, after multiple exposures to naphthalene, rats were examined at 2 weeks or 3, 6, 12, or 18 months to compare kinetic parameters over time with the single exposure. Dr. Melnick reported the results: (1) due to its low vapor pressure and high blood-to-air partition coefficient, most of the absorbed naphthalene (internalized dose) is eliminated via metabolism; (2) the steady state naphthalene concentration in the mouse lung at 30 ppm is slightly greater than in the rat lung at 30 ppm but less than in 60 ppm rats; (3) the rate of naphthalene metabolism is higher in mouse lung than rat lung; and (4) data are insufficient

to adequately estimate tissue concentrations of naphthalene oxide, the putative carcinogenic intermediate.

Dr. Cullen, a principal reviewer, agreed with the proposed conclusions. He said that because nasal adenomas are uncommon neoplasms, the discussion needs to address the likelihood of nasal adenomas to progress. Further, given the significant background on nasal inflammation and limited evidence of genetic toxicity, the role of inflammation in genesis of these lesions needs to be considered. Dr. R.A. Herbert, NIEHS, said the discussion on nasal adenomas would be expanded. Dr. J.R. Hailey, NIEHS, reported that he and Dr. J.K. Haseman, NIEHS, had looked at the 10 NTP studies showing nasal carcinogenesis and at the two studies showing the most severe degree of inflammation, and noted that these studies also reported the fewest numbers of neoplasms. Dr. Cullen noted that neuroblastomas are uncommon in humans as well as rats, and said that discussion of biological relevance to human health risk is warranted.

Dr. Medinsky, the second principal reviewer, agreed with the proposed conclusions. Her major criticism was that the pharmacokinetic model for naphthalene disposition in rats didn't include a nasal compartment, although the only carcinogenic effect seen was in the nose. She noted data suggesting that the isozyme that metabolizes naphthalene is present in the nose, and that naphthalene's high partition coefficient suggests nasal deposition. Dr. Melnick responded that NTP would like to include a nasal compartment and one way might be to combine the toxicokinetic model with a fluid dynamic model. The difficulty lies in not having data on naphthalene deposition in nasal mucosa to validate model estimates. Information is limited on fluid dynamic flow in the mouse nasal compartment, which would be needed for species comparison.

Dr. Hecht, the third principal reviewer, agreed with the proposed conclusions.

Dr. G. McCarver, Medical College of Wisconsin, asked if there was information on human levels of naphthalene or metabolites and how these would compare with levels in the toxicokinetic studies. Dr. G.W. Lucier, NIEHS, surmised that human levels of naphthalene or metabolites would be two orders of

magnitude lower for average individuals, not necessarily occupationally exposed.

Mr. R. Landis, Landis and Associates, representing the Naphthalene Panel of the Chemical Manufacturers Association, commented that an apparent decrease in thyroid gland neoplasms, the lack of an overall increase in the incidences of neoplasms, and the saturation of

lung metabolism with exposure should be addressed in the Results section.

Dr. Cullen moved that the Technical Report on naphthalene be accepted with the revisions discussed and with the conclusions as written. Dr. Drinkwater seconded the motion, which was accepted with six yes votes.

INTRODUCTION

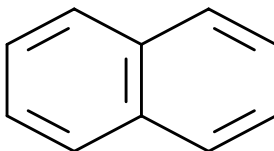

NAPHTHALENE

CAS No. 91-20-3

Chemical Formula: C₁₀H₈ Molecular Weight: 128.18

Synonyms: Mothballs; moth flakes; naphthalin; naphthaline; naphthene; tar camphor; white tar

Trade names: Albocarbon, Dezodorator, Mighty 150, Mighty RD1

CHEMICAL AND PHYSICAL PROPERTIES

Naphthalene is a white, crystalline solid with an aromatic odor. It has a boiling point of 218° C at 760 mm Hg, a melting point of 80.2° C, and a specific gravity of 1.162 at 20° C. It sublimates appreciably at temperatures above the freezing point (*Merck Index*, 1989). Naphthalene vapor has a partial pressure of 0.01 mm Hg and a density of 4.42 (*Kirk-Othmer*, 1979, 1981; *Sax's*, 1984). Naphthalene is soluble in alcohol (1 g/13 mL), benzene or toluene (1 g/3.5 mL), olive oil or turpentine (1 g/8 mL), and chloroform or carbon tetrachloride (1 g/2 mL) (*Merck Index*, 1989; Lide, 1992). It has an octanol/water partition coefficient of 3.30 (Hansch *et al.*, 1995).

PRODUCTION, USE, AND HUMAN EXPOSURE

Naphthalene is prepared from coal tar by fractional distillation to produce a crystalline fraction. This fraction is then purified by hot pressing and washing with sulfuric acid, sodium hydroxide, and water, followed by sublimation or a second fractional distillation (*Merck Index*, 1996). United States manufacturers produced 1.09×10^5 metric tons of naphthalene in 1996. United States consumption of naphthalene was 1.08×10^5 metric tons in 1996 and was projected to

increase to 1.15×10^5 metric tons in 2001 (*Chemical Economics Handbook*, 2000).

Naphthalene is used as an intermediate in the synthesis of phthalic and anthranilic acids, naphthols, naphthylamines, sulfonic acid, synthetic resins, celluloid, and hydronaphthalenes (*Merck Index*, 1996). It is also used in the preparation of anthraquinone, indigo, salicylic acid, and 1-naphthyl-N-methylcarbamate insecticide (*Kirk-Othmer*, 1978, 1979, 1981). It is an ingredient in some moth repellants and toilet bowl deodorants (Gosselin *et al.*, 1984). Naphthalene is used in antiseptics for irrigating animal wounds and as an external medication to control lice on livestock and poultry (Rossoff, 1974).

Naphthalene is a natural constituent of coal tar and crude oil, which are the major contributors to its presence in the environment. They contain up to 11% and 1.3% of the chemical, respectively (BUA, 1989; *Merck Index*, 1996). Forest fires also contribute to the presence of naphthalene in the environment, as the chemical is a natural combustion product of wood. Naphthalene has been identified in cigarette smoke (USEPA, 1980). Naphthalene may enter the soil and water as a result of spills from factories in which it is used as an intermediate or during the production and transport of products containing naphthalene. The

primary source of human exposure is from the atmosphere, especially in areas of heavy traffic, where fumes from burning gasoline or fuel oil exist, or near petroleum refineries and coal coking operations.

The concentrations of the naphthalene metabolites 1- and 2-naphthol were measured in the urine of human participants in a study conducted by the Centers for Disease Control and Prevention. 1-Naphthol was detected in 86% of 983 urine samples and 2-naphthol in 81% of 977 samples; the average concentrations were 17 µg/L and 7.8 µg/L, respectively. Although 1-naphthol is produced by the cleavage of carbaryl as well as from the oxidation of naphthalene, these results were considered to reflect naphthalene rather than carbaryl exposure due to the similarity of the results between the two metabolites (L. Needham, personal communication).

REGULATORY STATUS

The U.S. Environmental Protection Agency established a reference dose for naphthalene of 0.004 mg/kg per day and a drinking water equivalent concentration of 0.1 mg/L (USEPA, 1990). Several occupational standards were set for naphthalene. The Occupational Safety and Health Administration (OSHA) 8-hour, time-weighted average for exposure to airborne naphthalene is 10 ppm (NIOSH, 1997). Both the National Institute of Occupational Safety and Health (NIOSH, 1997) and the American Conference of Governmental Industrial Hygienists (ACGIH, 1999) recommend threshold limit values of 10 ppm for the 8-hour, time-weighted average and 15 ppm for the 15-minute, short-term exposure limit.

ABSORPTION, DISTRIBUTION, METABOLISM, AND EXCRETION

Experimental Animals

Naphthalene is readily absorbed when inhaled or administered orally or dermally. Naphthalene was not detected in the feces of rats (strain not specified) given 535 or 770 mg in feed or 100 mg by stomach tube, suggesting that naphthalene was readily absorbed (Chang, 1943). Naphthalene was readily absorbed by tissues of laying pullets, swine, and dairy cattle; the respective doses were 0.443, 2.46, or 30.69 mg, administered as a single oral dose, or 0.036, 0.112, or

5.115 mg administered daily for 31 days. The adipose tissue, kidney, liver, and lung of pullets had the highest naphthalene concentrations after a single dose, and the kidney had the highest concentration after 31 days of dosing. In swine, adipose tissue had the highest naphthalene concentration after a single dose, and the lung had the highest concentration after 31 days of dosing. In cattle, the liver had the highest concentrations after both treatments (Eisele, 1985).

Evidence for rapid absorption of naphthalene from the intestines was provided by Bock *et al.* (1979). Thirty minutes after instillation of 100 nmol of ¹⁴C-naphthalene into a closed rat intestinal loop, 84% was recovered unmetabolized in the portal blood, and only 1% was found in the luminal contents.

Absorption, metabolism, and excretion of dermally administered naphthalene were demonstrated in Sprague-Dawley rats (Turkall *et al.*, 1994). Each rat received 43 µg ¹⁴C-naphthalene through a small opening in a shallow glass cap tightly fixed with Lang's jet acrylic and powder to a shaved area of the skin (13 cm²) on the right costoabdominal region. The opening was sealed immediately. Forty-eight hours after dosing, 70% of the label was excreted in the urine, 14% in the expired air, and 4% in the feces. Radiolabel (0.01% to 0.02%) was found in the ileum and duodenum; this was considered by the authors to be evidence for biliary excretion of the chemical and its metabolites. Naphthalene metabolites identified in the urine were 2,7- and 1,2-dihydroxynaphthalene, 1,2-naphthoquinone, and 1- and 2-naphthol. Less than 0.5% of the parent compound was excreted in the urine. The plasma half-life was 2.1 hours for the absorption phase and 12 hours for the elimination phase.

As in the case of dermal absorption, naphthalene given intraperitoneally is absorbed, metabolized, and excreted primarily in the urine. Within 48 hours of an intraperitoneal injection of 100 mg/kg ¹⁴C-naphthalene in female Sprague-Dawley rats, 23% to 41% of the label was excreted in the urine and 5% to 10% in the bile. Of the label excreted in the urine, 5% to 20% was unconjugated, and 80% to 95% was sulfate, glucuronide, and mercapturic acid conjugates (Chen and Dorrough, 1979).

The first step in naphthalene metabolism is the formation of naphthalene 1,2-oxide by oxygen and the

NADPH-dependent microsomal monooxygenase system, followed by the formation of hydroxylated intermediates. These intermediates are then excreted in the urine as glutathione, cysteine, glucuronic acid, and sulfate conjugates (Horning *et al.*, 1980). Approximately 30 naphthalene metabolites were identified in the urine of mammals after oral gavage or intraperitoneal injection (Corner and Young, 1954; Horning *et al.*, 1980). Some of these metabolites are listed in Table 1. The table shows considerable interspecies similarities in the spectra of metabolites formed from naphthalene with some notable exceptions. 1,2-Dihydroxynaphthalene was formed only in guinea pigs, and no glucuronides were detected. Glutathione conjugation of naphthalene metabolites plays an important role in naphthalene's elimination in rodents but not in primates, including humans. Single gavage doses of 30, 75, or 200 mg naphthalene/kg body weight administered to male Wistar rats resulted in a dose-related increase in thioether excretion in the urine. By contrast, this increase was not seen in male or female chimpanzees treated similarly (Summer *et al.*, 1979).

Based on the spectrum of naphthalene metabolites found in mammals, a metabolic pathway for the chemical was suggested by Bock *et al.* (1976) and later modified to the one depicted in Figure 1 (BUA, 1989). An epoxide intermediate (naphthalene 1,2-oxide) was postulated as the initial metabolite, with subsequent

conversion to the trans-1,2-diol and other products (Sims and Grover, 1974). Support for this mechanism was first provided by Jerina *et al.* (1970), who demonstrated the formation of 1,2-naphthalene oxide from naphthalene in a microsomal system. Naphthalene was shown to be bioactivated by cytochrome P450 to electrophilic intermediates, which were subsequently metabolized to naphthoquinones and possibly to free radical intermediates (Buckpitt and Warren, 1983; Doherty *et al.*, 1985). Microsomal preparations from liver, lungs, kidneys, and skin were able to transform naphthalene metabolites. Human hepatic microsomal preparations metabolized naphthalene to 1-naphthol and naphthalene 1,2-dihydrodiol (Tingle *et al.*, 1993). Similar preparations from lung tissue metabolized naphthalene to 1,2-naphthalenediol and three different glutathione conjugates (Buckpitt and Richieri, 1984; Buckpitt and Bahnson, 1986), which were later identified as trans-1-(S)-hydroxy-2-(S)-glutathionyl-1,2-dihydronaphthalene; trans-1-(R)-hydroxy-2-(R)-glutathionyl-1,2-dihydronaphthalene, and trans-1-(R)-glutathionyl-2-(R)-hydroxy-1,2-dihydronaphthalene (Buonarati *et al.*, 1990). Pulmonary, hepatic, and renal microsomal preparations from rats, mice, or hamsters converted naphthalene to these conjugates in the presence of glutathione and glutathione transferases (Buckpitt *et al.*, 1987). In a recent *in vitro* study with mouse lung Clara cells treated with naphthalene, Zheng *et al.* (1997) identified 1,2-naphthoquinone to be a major adduct covalently bound to cellular protein.

TABLE 1
Metabolites of Naphthalene Identified in the Urine of Various Species^a

	Rat	Mouse	Rabbit	Guinea Pig
1-Naphthol	+	+	+	+
1-Naphthyl sulphate	+	+	+	+
1-Naphthyl glucuronide	+	+	+	-
2-Naphthol	+	+	+	+
1,2-Dihydroxynaphthalene	-	-	-	+
1,2-Dihydro-1,2-dihydroxynaphthalene	+	+	+	+
1,2-Dihydro-2-hydroxy-1-naphthyl glucuronide	+	-	+	-
1-Naphthyl mercapturic acid	+	+	+	+

^a + = metabolite present; - = metabolite not present; from BUA (1989)

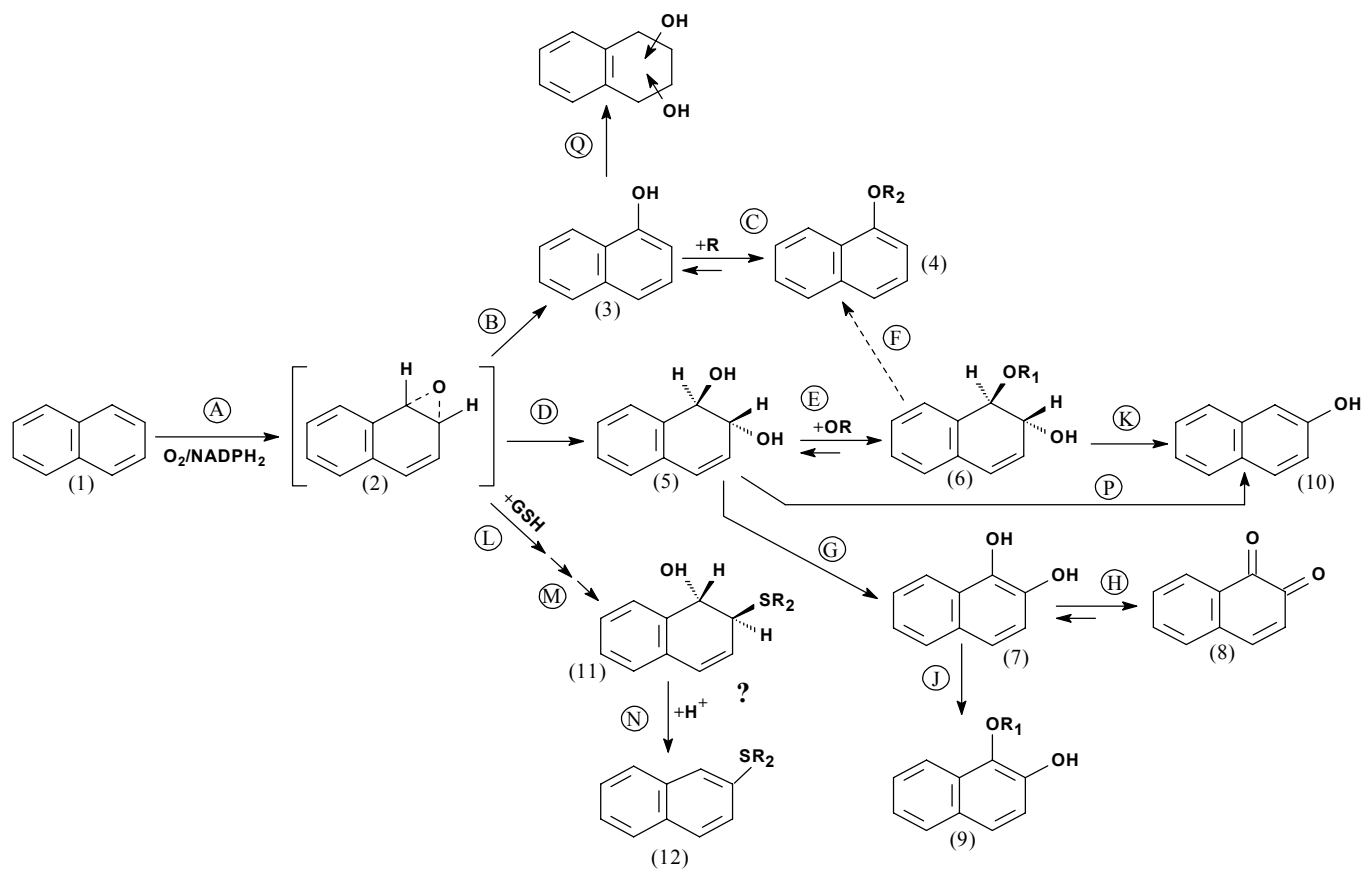

- (1) Naphthalene
 (2) Naphthalene-1,2-oxide
 (3) Naphthol
 (4) Naphthyl glucuronide or sulphate
 (5) Trans-1,2-dihydro-2-hydroxy-naphthalene
 (6) Trans-1,2-dihydro-2-hydroxy-naphthyl-1-glucuronide
 (7) 1,2-Dihydroxynaphthalene
 (8) 1,2-Naphthoquinone
 (9) 2-Hydroxynaphthyl-1-sulphate or -glucuronide
 (10) 2-Naphthol
 (11) N-Acetyl-S-(1,2-dihydro-1-hydroxy-2-naphthyl)-L-cysteine
 (12) N-Acetyl-S-(1-naphthyl)-L-cysteine (1-naphthyl mercapturic acid)

GSH = Glutathione

R₁ = Sulphate or glucuronate group

R₂ = N-acetyl-L-cysteine residue

A,Q = O₂- and NADPH₂-dependent mono-oxygenase
 (e.g., cyt-P450-NADP-cytochrome-c-reductase system,
 microsomal)

B = Spontaneous isomerization

C,E,J = Conjugation reaction with sulphate
 (sulphotransferase, cystolic) or with glucuronic acid
 (UDP-glucuronyl-transferase, microsomal)

D = Epoxide hydrolase, synonym: epoxide hydrase
 (microsomal)

F,N,P = Chemical dehydration
 G = Dihydrodiol-dehydrogenase (cystosolic);
 3,5-cyclohexadiene-1,2-diol-NADP-oxidoreductase

H = Chemical dehydration

K = Chemical hydrolysis + dehydration

L = Enzymatic reaction with glutathione

M = γ -Glutamyl transferase, peptidase, N-acetylase

FIGURE 1
Essential Metabolic Pathways of Naphthalene and the Resulting Products
in Mammals (based on BUA, 1989)

Humans

Absorption of naphthalene is evidenced by the occurrence of toxic symptoms in infants accidentally exposed to vapors from clothes containing naphthalene (Valaes *et al.*, 1963). Transplacental transport of naphthalene and/or its metabolites is evidenced by the occurrence of hemolytic anemia in newborns whose mothers ingested naphthalene during the last 3 months of pregnancy (Zinkham and Childs, 1958; Anziulewicz *et al.*, 1959).

TOXICITY

Experimental Animals

The reported LD₅₀ values for rats and mice, respectively, are 1,110 to 9,430 mg/kg and 350 to 710 mg/kg (oral), 2,500 and 969 mg/kg (dermal), and 1,000 and 350 mg/kg (intraperitoneal) (BUA, 1989). These values suggest that mice are more sensitive than rats to the acute effects of naphthalene. The reported LC₅₀ value for rats exposed to naphthalene vapors for 8 hours was 500 mg/m³ (BUA, 1989). The major sites affected by naphthalene toxicity are the hematologic and pulmonary systems and the eye.

Hematologic Effects: Although human subjects accidentally exposed to naphthalene by ingestion developed hemolytic anemia, animals appear to be less sensitive to the hemolytic effects of the chemical. Toxic effects observed in CD-1 mice administered 267 mg/kg naphthalene in corn oil by gavage once a day for 14 days included reduced body weight gain, reduced absolute thymus weight (males), reduced spleen and lung weights (females), elevation of blood bilirubin concentration, and 5% to 10% mortality. There was a slight alteration in hematologic parameters, but there was no hemolytic anemia, cataracts, or lung damage (Shopp *et al.*, 1984).

Dogs that received daily oral doses of naphthalene (263 or 1,525 mg/kg body weight per day for 7 days) mixed in feed developed hemolytic anemia (Zuelzer and Apt, 1949). The cumulative results of the mouse and dog studies suggest that mice are less sensitive than dogs to the hemolytic effects of naphthalene.

Ocular Effects: Lens opacity was reported in black-hooded and brown Norway rats given 700 or 5,000 mg naphthalene/kg per day for 79 to 102 days (Rathbun *et al.*, 1990; Tao *et al.*, 1991). Cataracts involving the whole eye lens occurred in pigmented and albino

rabbits within 2 weeks of daily oral administration with 1 g/kg naphthalene, with the greater incidence in the albino strain (Potts, 1996). van Heyningen (1979) reviewed cataract formation in albino rats and albino rabbits resulting from naphthalene administration and concluded that, although the toxic agent in both species is the liver metabolite 1,2-dihydroxynaphthalene, phenol oxidase was the primary metabolic enzyme in rats and catechol oxidase was the primary enzyme in rabbits. This is consistent with the observation that the pigmented strain of rats was more susceptible to cataract formation than the albino strain because phenol oxidase is found only in the pigmented strain. Albino and pigmented rabbits responded similarly to naphthalene for lens opacity (Koch and Doldi, 1975). The strain difference observed in rats also appears to occur in mice. Shichi *et al.* (1980) have reported correlations between the Ah^b allele and cataract formation in nine inbred mouse strains (four responsive at the Ah locus and five nonresponsive), with cataracts developing only in the responsive strains. Animals were exposed concomitantly to daily administration of 60 mg/kg β -naphthoflavones and to 120 mg/kg naphthalene in a 60-day study to determine the induction of total body cytochrome P450 (CYP1A and CYP2A).

A study conducted with biochemical probes on male C57BL/6J mice suggests that naphthalene cataractogenesis requires P450 (CYP1A and CYP2A) bioactivation to a reactive metabolite (possibly a naphthoquinone), a free radical derivative, or a combination of both (Wells *et al.*, 1989). In these studies, a pretreatment of mice with SKF-525A or α -phenyl-N-butyl nitron in addition to treatment with vitamin E or caffeic acid inhibited naphthalene cataractogenicity.

L-Cysteine prodrugs (thiozolidine-4-carboxylic acid; N-acetyl-L-cysteine; N,S-bis-acetyl-L-cysteine; glutathione ethyl ether; 2-mercaptoethanol/L-cysteine) were also effective in preventing naphthalene-induced cataracts in mouse lenses, apparently by maintaining hepatic glutathione concentrations (Rathbun *et al.*, 1996a,b). In a feed study in black-hooded rats, Rathbun *et al.* (1990) found that the glutathione concentration and glutathione peroxidase and glutathione reductase activities were significantly reduced in the eye lens of rats fed diets containing 5,000 mg naphthalene per kg body weight daily for 30 days. No changes were observed in the activity of glutathione

synthetase or γ -glutamylcysteine synthetase. It was concluded that naphthalene-induced cataracts may be due to impairment of the defense system against oxidative damage.

Pulmonary Effects: The respiratory tract has been identified as a site of naphthalene toxicity in rats and mice. A single intraperitoneal injection of 0.05 or 2 mmol/kg induced necrosis of the bronchial/bronchiolar epithelium in C57BL/6J mice (Mahvi *et al.*, 1977). This lesion was reversible, and regeneration occurred after 7 days. Necrosis of the bronchial epithelial (Clara) cells occurred in the lungs of C57BL/6J mice given a single intraperitoneal injection of 125 or 250 mg/kg naphthalene (Tong *et al.*, 1981, 1982).

Rats are more tolerant to naphthalene toxicity than mice. An intraperitoneal injection of 400 or 600 mg/kg in Swiss T.O. mice damaged the Clara cells in the lung and proximal tubule epithelial cells of the kidney. In contrast, an intraperitoneal injection of 1,600 mg/kg in Wistar-derived rats did not produce any damage in the lung or the kidney (O'Brien *et al.*, 1985). The difference in susceptibility was attributed to variation in the metabolism rate of the two species. It was found that the covalent binding and metabolism of naphthalene were 10% greater in microsomes prepared from mouse lung than those prepared from rats. Using microdissected airways, Buckpitt *et al.* (1995) found that the rate of naphthalene metabolism was higher in mouse airways than in the airways of rats or hamsters. Additionally, the metabolism of naphthalene in the distal airways was higher than in the trachea of the mouse, rat, or hamster.

Plopper *et al.* (1992) studied the histopathologic changes of the respiratory tract 24 hours after parental administration of a single oral dose of naphthalene in corn oil to Swiss Webster mice (0 to 400 mg/kg), Sprague-Dawley rats (0 to 1,600 mg/kg), and Syrian hamsters (0 to 800 mg/kg). They found that naphthalene injury (swelling, vacuolization, exfoliation, and/or necrosis) to the tracheobronchial epithelium in the mice was specific to Clara cells. It occurred with a dose-related trend in the terminal bronchioles and involved proximal airways. Clara cells in the rat were refractory to injury, and proximal airways were more susceptible than distal airways in the hamster. Naphthalene was cytotoxic to the olfactory epithelium in rats and mice, with the effect seen at a much higher

dose in mice (200 mg/kg versus 400 mg/kg). Recent studies with adult and neonatal Swiss Webster mice showed that Clara cells in the neonates are more susceptible to injury by bioactivated naphthalene exposure than those of the adult mice (Fanucchi *et al.*, 1997).

In vivo studies with airway explants from sensitive species (mice) and nonsensitive species (rats and hamsters) showed that the cells from mice contain a unique P450 (CYP2F, a family of microsomal enzymes uniquely expressed in the lung and olfactory mucosal cells; Lakritz *et al.*, 1996; Shultz *et al.*, 1999) enzyme capable of stereospecific metabolism of naphthalene to 1-(R)-2-(S)-naphthalene oxide; 1-(R)-2-(S)-naphthalene epoxide was not detected in rats or hamsters. Cells from rats and hamsters metabolized naphthalene to these two metabolites, with the latter metabolite predominant (Chang *et al.*, 1991). The rate of naphthalene metabolism by microsomal preparations from rat, hamster, or monkey livers was considerably lower (12%, 37%, and 1%, respectively) than that obtained from similar preparations of mouse liver. The mouse lung microsomal preparation favored the formation of the 1-(R)-2-(S)- over the 1-(S)-2-(R)-epoxide. In the nonsensitive species (rats and hamsters), the opposite was true (Buckpitt *et al.*, 1992).

Pulmonary toxicity of a single intraperitoneal injection of naphthalene (1.6 mmol), 2-methylnaphthalene (2.8 mmol), 2-isopropylnaphthalene (17.6 mmol), and 2,6-diisopropylnaphthalene (14.2 mmol) was studied in ddY mice. The first two compounds caused pulmonary toxicity, significant depletion of reduced glutathione, and increased binding to lung tissue relative to isopropylnaphthalenes. These results suggest that lung toxicity of naphthalene and its alkyl substituent is inversely related to the alkyl chain length. Additionally, the results suggest that the toxicity of naphthalene is dependent on its ability to deplete glutathione and to bind to lung tissue (Honda *et al.*, 1990).

Other Effects: Naphthalene administered orally in corn oil (120 mg/kg per day for 120 consecutive days) resulted in oxidative stress (increased lipid peroxidation) and DNA breakage in liver and brain tissue of Sprague-Dawley rats (Bagchi *et al.*, 1998). Vuchetich *et al.* (1996) showed that treatment of female Sprague-Dawley rats with vitamin E succinate 3 days before and 4 days after administration of a single oral

dose of 1,100 mg naphthalene protected these rats from oxidative stress and reduced DNA breakage in hepatic tissue.

A single intraperitoneal injection of naphthalene (1 g/kg) caused ammonia accumulation in the brain of rats. The accumulation of ammonia correlated positively with the lethality of the compound (Bolonova, 1967). Brain ammonia reacts with glutamic acid along with glutamine dehydrogenase as a catalyst to form glutamine (de Bruin, 1976). Naphthalene inhibited aryl hydrocarbon hydroxylase activity in liver homogenates and microsomal preparations obtained from rats given 40 mg/kg intraperitoneal injections for 3 days (Alexandrov and Frayssinet, 1973). A single intraperitoneal dose of 250 mg/kg naphthalene to C57BL/6J mice depressed the enzyme activity of microsomal monooxygenase in the lung by 30% to 70%; enzyme activity was not affected in the liver (Tong *et al.*, 1982).

Humans

Naphthalene inhalation in humans causes headache, confusion, eye irritation, nausea, and profuse perspiration with vomiting, optic neuritis, hematuria, and edema. Naphthalene ingestion has resulted in abdominal pain, nausea, vomiting, diarrhea, darkening of the urine, irritation of the bladder, jaundice, anemia, and hypothermia (Gerarde, 1960). Toxicity and death have been reported in newborn infants exposed to naphthalene vapors from clothes containing it (Valaes *et al.*, 1963).

Cataract formation has been reported in humans exposed to naphthalene. A pharmacist ingesting 5 g naphthalene developed bilateral cataracts as well as optic nerve atrophy and blindness (Lezenius, 1902). Two workers occupationally exposed to powdered naphthalene developed cataracts, retinal hemorrhage, and chorioretinitis (Van der Hoeve, 1906). Cataracts were diagnosed in 8 of 29 chemical plant workers exposed to naphthalene for 5 years (Ghetti and Mariani, 1956).

Naphthalene poisoning has produced hemolytic anemia in children (Zuelzer and Apt, 1949; Dawson *et al.*, 1958; Zinkham and Childs, 1958; Santhanakrishnan *et al.*, 1973) and adults (Taylor and Russell, 1932; Konar *et al.*, 1939). Individuals with decreased

glucose-6-phosphate dehydrogenase activity are particularly susceptible to this effect (Haddad and Winchester, 1983; Melzer-Lange and Walsh-Kelly, 1989). This enzyme is essential for the regeneration of erythrocyte NADPH, a cofactor required for the regeneration of reduced glutathione. The latter is used by the antioxidant enzyme erythrocyte glutathione peroxidase (a selenium containing enzyme essential for protecting cell membrane integrity). Notable features of the hemolytic anemia included Heinz-body formation, hemoglobinuria, and decreases in hemoglobin, hematocrit, erythrocyte counts, and stimulation of hematopoiesis. The hemolytic anemia was followed by renal failure (MacGregor, 1954; Gidron and Leurer, 1956). A case of aplastic anemia was reported in a woman exposed to dichlorobenzene and naphthalene vapors, but the association is uncertain due to the lack of other substantiating reports (Harden and Baetjer, 1978).

CARCINOGENICITY

Experimental Animals

In a 2-year inhalation study in B6C3F₁ mice, naphthalene was a respiratory toxicant and carcinogen (Abdo *et al.*, 1992; NTP, 1992). In this study, male and female mice were exposed to naphthalene vapors (0, 10, or 30 ppm) 6 hours per day, 5 days per week. Naphthalene was carcinogenic to female mice, resulting in an increased incidence of alveolar/bronchiolar adenoma in the 30 ppm group. Additionally, naphthalene caused exposure-related increases in the incidences of chronic inflammation, metaplasia of the olfactory epithelium, and hyperplasia of the respiratory epithelium of the nose as well as exposure-related increases in the incidences of chronic inflammation of the lung in male and female mice.

Daily 6-hour exposures to atmospheres of 30 ppm naphthalene for 6 months did not elicit a significant increase in the incidence of lung adenoma in A/J mice, but histopathologic evaluation of lungs from the animals revealed an increased incidence of multiple alveolar adenoma relative to the concurrent chamber controls. However, the number of tumors per tumor-bearing lung in the concurrent controls was significantly less than those observed in the unexposed controls for this strain of mice (Adkins *et al.*, 1986). The results of this study suggest that the evidence for carcinogenicity in this strain of mice is equivocal.

Negative results were reported in early naphthalene dermal studies, but experimental details were unavailable (Kennaway, 1930). A rat dermal study with 1,4-naphthoquinone, a naphthalene metabolite, resulted in skin papilloma incidences of 15% to 20%, with some papillomas leading to malignant epitheliomas (Takizawa, 1940). Tumors occurred in 9 of 25 black mice receiving naphthalene in benzene and in 3 of 21 black mice receiving benzene control in a lifetime (5 days/week) dermal study (Knake, 1956). In the exposed mice, four had lymphatic leukemia, three had lung adenomas, one had lymphosarcoma, and one had nonspecified tumor; in the benzene controls, one had lymphosarcoma, one had lung adenoma, and one had nonspecified tumor. Boyland *et al.* (1964) examined the effects of implanting naphthalene in the urinary bladder of mice and found a 4% incidence of carcinoma after 30 weeks, which was similar to the effect of implanting inert substances such as glass.

A group of 40 rats administered seven subcutaneous biweekly doses of 500 mg/kg naphthalene in benzene and then observed for 18 months had a 15% tumor incidence (five animals with lymphosarcoma and one with fibroadenoma), while 5% and 2% tumor incidences occurred in vehicle and unexposed controls (Knake, 1956). No carcinogenic activity or toxic effects were evident, either in rats given a total of 10 g naphthalene orally over a 700-day period or in rats given 820 mg subcutaneously or intraperitoneally over a 40-week period (Schmahl, 1955). No controls were used in this study, but a concurrent study with anthracene administered subcutaneously did detect tumors.

Humans

In East Germany (now part of the Federal Republic of Germany), four cases of laryngeal carcinoma, a case of gastric carcinoma, a case of colon carcinoma, and a case of lupus erythromatosus were reported among 7 of 15 employees involved in the manufacture of naphthalene (Wolf, 1976). Seven tumor-free workers suffered various degrees of rhinopharyngolaryngitis, an inflammation possibly conducive to prodromal carcinogenesis. Laryngeal cancer developed in 4 of 15 naphthalene distillation plant workers (Wolf, 1978). The incidence of laryngeal cancer in these distillation workers was approximately 4,000 times greater than the general incidence of laryngeal cancer in East Germany. Kup (1978) studied 15 patients: 12 with laryngeal carcinomas, two with epipharyngeal cancer, and one

with nasal carcinoma. He observed that four of the pharyngeal cancer patients were exposed to naphthalene but suggested that most of the cancer was not work related as most of the workers were smokers as well. No other studies investigating carcinogenesis and exposure to naphthalene in humans were found.

GENETIC TOXICITY

There is little evidence for mutagenic potential of naphthalene in the most widely used genotoxicity assays. Naphthalene was not mutagenic in *Salmonella typhimurium* gene mutation studies, with or without S9 metabolic activation enzymes (Connor *et al.*, 1985; Nohmi *et al.*, 1985; Sakai *et al.*, 1985; Mortelmans *et al.*, 1986; Narbonne *et al.*, 1987; Bos *et al.*, 1988), nor was it active in the SOS chromotest for induction of DNA damage in *Escherichia coli* PQ37 (Mersch-Sundermann *et al.*, 1992). In addition, it failed to induce sister chromatid exchanges in human lymphocytes *in vitro* in the presence of human liver microsomal activation enzymes (Tingle *et al.*, 1993; Wilson *et al.*, 1995). Naphthalene was not mutagenic to metabolically competent human lymphoblastoid MCL-5 cells at either the heterozygous *tk* locus or the hemizygous *hprt* locus (Sasaki *et al.*, 1997). However, a small but significant increase in the number of micronuclei was observed in these cells after exposure to 30 µg/mL naphthalene (Sasaki *et al.*, 1997). These micronuclei were Crest stain negative, indicating that they contained acentromeric fragments rather than whole chromosomes. Naphthalene produced a small dose-related increase in micronucleated erythrocytes of salamanders exposed in water for 12 days during the larval stage to naphthalene concentrations of 0.24 and 0.50 ppm (Djomo *et al.*, 1995).

In a *Drosophila melanogaster* somatic mutation and recombination test, naphthalene, when fed to larvae for 48 hours at concentrations of 1 to 10 mM, induced significant increases in wing spots in a standard cross and in a high bioactivation cross that used strains with increased cytochrome P450 activity (Delgado-Rodriguez *et al.*, 1995). The wing-spot pattern observed following exposure to naphthalene indicated that mutations were induced in both strains of *D. melanogaster*, but the response in the metabolically enhanced strain was stronger; chromosomal recombinations occurred in these flies in addition to mutations.

Two nitro derivatives of naphthalene, 1-nitronaphthalene and 1,5-dinitronaphthalene, also induced somatic mutations in this assay, but the responses were weaker than those observed with naphthalene.

The metabolites of naphthalene, 1,2-dihydro-1,2-dihydroxy naphthalene, 1-naphthol, and 2-naphthol, were nonmutagenic in *S. typhimurium* (Narbonne *et al.*, 1987; Florin *et al.*, 1980; Probst *et al.*, 1981), but 2-naphthol was shown to induce growth inhibition in DNA repair-deficient strains of *E. coli* (Suter and Jaeger, 1982) and *Bacillus subtilis* (Tanooka, 1977; Kawachi *et al.*, 1980; Suter and Jaeger, 1982), presumably through induction of DNA damage. Unscheduled DNA synthesis was not observed in cultured rat hepatocytes treated with 2-naphthol (Probst *et al.*, 1981).

STUDY RATIONALE

NIOSH, OSHA, and USEPA made the original nomination to test naphthalene for carcinogenicity based on the potential for chronic exposure to humans through the use of mothballs in the home and the lack of adequate carcinogenicity studies in the literature to reach a regulatory decision. Potential chronic exposure can occur occupationally and through cigarette smoke (3 µg naphthalene/cigarette; Schmeltz *et al.*, 1978).

Based on this nomination and because of the lack of carcinogenic activity of naphthalene in the oral rat study reported by Schmahl (1955), the NTP decided to study the carcinogenic potential of naphthalene in mice only. This study was completed and peer reviewed in 1991 (NTP, 1992). Because of the positive carcinogenic response (an increased incidence of lung adenoma in exposed female mice), members of the peer review panel recommended and the NTP concurred that an inhalation study in rats should be conducted. The recommendation was made because previous studies with naphthalene in rats have been conducted using routes other than inhalation (the major route for human exposure) and because the Schmahl (1955) study would be considered inadequate due to the small number of animals used (28 rats were dosed once daily, six times per week, until each was administered a total of 10 g over a 700-day period, or about 41 mg/kg per day).

A 2-year carcinogenicity study was conducted by exposing groups of 50 male and 50 female F344/N rats to atmospheres containing 0, 10, 30, or 60 ppm naphthalene vapor. The highest exposure concentration selected is the maximum that can be used without condensation of naphthalene in the chambers. The lowest exposure concentration represents the threshold limit value-time-weighted average established by the ACGIH (1999).

MATERIALS AND METHODS

PROCUREMENT AND CHARACTERIZATION OF NAPHTHALENE

Naphthalene was obtained from Aldrich Chemical Co. (Milwaukee, WI) in one lot for use in the 2-year study. Identity, purity, and/or stability analyses were conducted by the analytical chemistry laboratory, Research Triangle Institute (Research Triangle Park, NC) and by the study laboratory, Battelle Toxicology Northwest (Richland, WA) (Appendix E). Reports on analyses performed in support of the naphthalene study are on file at the National Institute of Environmental Health Sciences.

The chemical, a white crystalline solid, was identified as naphthalene by infrared and proton nuclear magnetic resonance spectroscopy and by gas chromatography/mass spectroscopy. The purity was determined by elemental analyses, gas chromatography/mass spectroscopy, and gas chromatography with flame ionization detection (FID). Elemental analyses for carbon and hydrogen were in agreement with theoretical values for naphthalene; 0.12% sulfur was also detected. Gas chromatography/mass spectroscopy indicated no impurities. Gas chromatography/FID indicated one major peak and one impurity with an area of approximately 0.6%; the impurity was tentatively identified as thionaphthene. The overall purity was determined to be greater than 99%.

Stability of the bulk chemical was monitored by the study laboratory using gas chromatography with FID. To ensure stability, the bulk chemical was stored under a nitrogen headspace at room temperature in metal drums lined with plastic. No degradation of the bulk chemical was detected.

VAPOR GENERATION AND EXPOSURE SYSTEM

The generator consisted of a 2-L glass reaction flask surrounded by a heated mantle. Heated nitrogen metered into the flask carried the vaporized naphthalene out of the generator. The mantle and nitrogen temperatures were adjusted to maintain the temperature of the vapor above the bulk naphthalene between 66° and 71° C while the bulk chemical was monitored to ensure that its temperature was maintained below the melting point.

A heated Teflon® line transported the vapor to the exposure room. The vapor was diluted with heated, HEPA- and charcoal-filtered air before entering a distribution manifold. Flow into the chamber was controlled by a chamber exposure valve. When the valve was in the exposure position, an AirVac pump (Air-Vac Engineering Co., Inc., Milford, CT) withdrew the appropriate amount of naphthalene vapor from the distribution manifold. The naphthalene vapor was injected into the chamber as it was mixed and diluted with conditioned chamber air to obtain the target concentration.

The study laboratory designed the inhalation exposure chamber (Harford Systems Division of Lab Products, Inc., Aberdeen, MD) so that uniform vapor concentrations could be maintained throughout the chamber with the catch pans in place. The total active mixing volume of each chamber was 1.7 m³. Before the study began, a small particle detector (Type CN, Gardner Associates, Schenectady, NY) was used with and without animals in the exposure chambers to ensure that naphthalene vapor, and not aerosol, was produced. A Type CN small particle detector was also used to determine the

maximum attainable concentration without aerosolization. Naphthalene aerosol was detected at a vapor concentration of approximately 85 ppm; therefore, a maximum concentration of 60 ppm was selected. During the 2-year study, no particle counts above the minimum resolvable level (approximately 200 particles/cm³) were detected.

VAPOR CONCENTRATION MONITORING

The naphthalene concentrations in the exposure chambers were monitored by an online gas chromatograph; the average chamber concentrations were maintained within 1% of the target concentrations. Samples were drawn from each exposure chamber approximately every 24 minutes using a 12-port stream select valve. The online gas chromatograph was checked throughout the day for instrument drift against an online standard of naphthalene. The online gas chromatograph was calibrated monthly by a comparison of chamber concentration data to data from grab samples, which were collected with charcoal sampling tubes and analyzed by an offline gas chromatograph. The offline gas chromatograph was calibrated with gravimetrically prepared standards of naphthalene containing 1-phenylhexane as an internal standard in toluene.

CHAMBER ATMOSPHERE CHARACTERIZATION

Buildup and decay rates for chamber vapor concentrations were determined with and without animals present in the chambers. At a chamber airflow rate of 15 air changes per hour, the theoretical value for the time to achieve 90% of the target concentration after the beginning of vapor generation (T_{90}) and the time for the chamber concentration to decay to 10% of the target concentration after vapor generation was terminated (T_{10}) was approximately 12.5 minutes. Based on experimental data, a T_{90} value of 12 minutes was selected for the study.

Evaluations of chamber uniformity and persistence and monitoring for naphthalene degradation impurities were conducted periodically throughout the study by gas chromatography. Chamber uniformity was maintained; no degradation was detected.

2-YEAR STUDIES

Study Design

The exposure concentrations for the naphthalene study were selected based on the results of a 2-year study in mice in which animals were exposed to 0, 10, or 30 ppm (NTP, 1992). Additionally, the highest exposure concentration (60 ppm) was selected to allow for variations in the maximum achievable concentration without aerosolization, determined by the study laboratory to be approximately 80 ppm, due to changes in temperature or operating conditions within the exposure system. The lowest concentration of 10 ppm is the threshold limit value for naphthalene (ACGIH, 1999).

Groups of 49 male and 49 female rats were exposed to naphthalene at concentrations of 0, 10, 30, or 60 ppm for 6 hours plus T_{90} (12 minutes) per day, 5 days per week for 105 weeks. Additional groups of male and female rats were exposed similarly to 10, 30, or 60 ppm for up to 18 months for evaluation of toxicokinetic parameters; no additional evaluations of these animals were performed.

Source and Specification of Animals

Male and female F344/N rats were obtained from Taconic Laboratory Animals and Services (Germantown, NY). The animals were quarantined for 14 days before the beginning of the study. Five male and five female rats were randomly selected for parasite evaluation and gross observation of disease. The animals were approximately 6 weeks old at the beginning of the study. The health of the animals was monitored during the study according to the protocols of the NTP Sentinel Animal Program (Appendix G).

Animal Maintenance

The animals were housed individually. Feed was available *ad libitum*, except during the exposure period; water was available *ad libitum*. Cages and chambers were changed weekly. Further details of animal maintenance are given in Table 2. Information on feed composition and contaminants is provided in Appendix F.

Clinical Examinations

All animals were observed twice daily. Body weights were recorded on study day 1, every 4 weeks beginning at week 4, and every 2 weeks beginning at week 92. Clinical findings were recorded every 4 weeks beginning at week 4 and every 2 weeks beginning at week 92.

Toxicokinetics

Groups of nine male and nine female rats were exposed to 10, 30, or 60 ppm naphthalene 6 hours per day plus T₉₀ for 5 days per week, excluding holidays and weekends, for up to 18 months. Blood samples were drawn from the retroorbital sinus at 2 weeks and 3, 6, 12, and 18 months. The samples were collected from three males and three females per group at six time points after exposure. Samples were collected twice (2 hours apart) from each rat via alternating sinuses. The samples of whole blood were immediately frozen in plastic screw-cap vials and shipped on dry ice to CEDRA Corporation (Austin, TX) for analyses of naphthalene concentrations. The samples were analyzed with a validated high-performance liquid chromatography method with ultraviolet light detection.

Pathology

Complete necropsies and microscopic examinations were performed on all core study animals. At necropsy, all organs and tissues were examined for grossly visible lesions, and all major tissues were fixed and preserved in 10% neutral buffered formalin, processed and trimmed, embedded in paraffin, sectioned to a thickness of 4 to 6 µm, and stained with hematoxylin and eosin for microscopic examination. For all paired organs (e.g., adrenal gland, kidney, ovary), samples from each organ were examined. Tissues examined microscopically are listed in Table 2.

Microscopic evaluations were completed by the study laboratory pathologist, and the pathology data were entered into the Toxicology Data Management System. The slides, paraffin blocks, and residual wet tissues were sent to the NTP Archives for inventory, slide/block match, and wet tissue audit. The slides, individual animal data records, and pathology tables were

evaluated by an independent quality assessment laboratory. The individual animal records and tables were compared for accuracy, the slide and tissue counts were verified, and the histotechnique was evaluated. For the 2-year study, a quality assessment pathologist evaluated slides from all tumors and all potential target organs, which included the nose and lung of male and female rats. In addition, the liver and preputial gland of male rats and the kidney, pancreas, and uterus of female rats were evaluated for specific lesions.

The quality assessment report and the reviewed slides were submitted to the NTP Pathology Working Group (PWG) chairperson, who reviewed the selected tissues and addressed any inconsistencies in the diagnoses made by the laboratory and quality assessment pathologists. Representative histopathology slides containing examples of lesions related to chemical administration, examples of disagreements in diagnoses between the laboratory and quality assessment pathologists, or lesions of general interest were presented by the chairperson to the PWG for review. The PWG consisted of the quality assessment pathologist and other pathologists experienced in rodent toxicologic pathology. This group examined the tissues without any knowledge of exposure groups or previously rendered diagnoses. When the PWG consensus differed from the opinion of the laboratory pathologist, the diagnosis was changed. Final diagnoses for reviewed lesions represent a consensus between the laboratory pathologist, reviewing pathologist(s), and the PWG. Details of these review procedures have been described, in part, by Maronpot and Boorman (1982) and Boorman *et al.* (1985). For subsequent analyses of the pathology data, the decision of whether to evaluate the diagnosed lesions for each tissue type separately or combined was generally based on the guidelines of McConnell *et al.* (1986).

TABLE 2
Experimental Design and Materials and Methods in the 2-Year Inhalation Study of Naphthalene

Study Laboratory

Battelle Toxicology Northwest (Richland, WA)

Strain and Species

F344/N rats

Animal Source

Taconic Laboratory Animals and Services (Germantown, NY)

Time Held Before Studies

14 days

Average Age When Studies Began

6 weeks

Date of First Exposure

28 March 1996

Duration of Exposure

6 hours plus T₉₀ (12 minutes) per day, 5 days per week, for 105 weeks

Date of Last Exposure

27 March 1998

Necropsy Dates

30 March-2 April 1998

Average Age at Necropsy

110-111 (males) or 111 (females) weeks

Size of Study Groups

Core study: 49 males and 49 females

Toxicokinetic study: 9 males and 9 females

Method of Distribution

Animals were distributed randomly into groups of approximately equal initial mean body weights.

Animals per Cage

1

Method of Animal Identification

Tail tattoo

Diet

NTP-2000 irradiated pelleted diet (Zeigler Brothers, Inc., Gardners, PA), available *ad libitum* except during exposure periods, changed weekly

Water

Softened tap water (Richland municipal supply) via automatic watering system (Edstrom Industries, Waterford WI), available *ad libitum*

Cages

Stainless steel, wire-bottom (Hazelton Systems, Inc., Aberdeen, MD), changed weekly

Chamber Air Supply Filters

Single HEPA (Northland Filter Systems International, Mechanicville, NY) charcoal (RSE, Inc., New Baltimore, MI); Purafil (Environmental Systems, Lynnwood, WA)

TABLE 2
Experimental Design and Materials and Methods in the 2-Year Inhalation Study of Naphthalene

Chambers

Stainless steel (Harford System, Division of Lab Products, Inc., Aberdeen, MD), changed weekly

Chamber Environment

Temperature: 75° ± 3° F

Relative humidity: 55% ± 15%

Room fluorescent light: 12 hours/day

Chamber air changes: 15 ± 2/hour

Exposure Concentrations

0, 10, 30, and 60 ppm

Type and Frequency of Observation

Observed twice daily; animals were weighed at the beginning of the studies, every 4 weeks beginning at week 4, and every 2 weeks beginning at week 92. Clinical findings were recorded every 4 weeks beginning at week 4 and every 2 weeks beginning at week 92.

Method of Sacrifice

Carbon dioxide asphyxiation

Necropsy

Necropsy was performed on all core study animals.

Histopathology

Complete histopathology was performed on all core study animals. In addition to gross lesions and tissue masses, the following tissues were examined: adrenal gland, bone with marrow, brain, clitoral gland, esophagus, eyes, heart, large intestine (cecum, colon, rectum), small intestine (duodenum, jejunum, ileum), kidney, larynx, liver, lung with mainstem bronchi, lymph nodes (mandibular, mesenteric, bronchial, mediastinal), mammary gland (females), nose, ovary, pancreas, parathyroid gland, pituitary gland, preputial gland, prostate gland, salivary gland, skin, spleen, stomach (forestomach and glandular), testis (with epididymis and seminal vesicle) thymus, thyroid gland, trachea, urinary bladder, and uterus.

Toxicokinetic Study

Blood was collected from the retroorbital sinus of toxicokinetic study rats at 2 weeks and at 3, 6, 12, and 18 months. Blood was collected 0, 30, 60, 120, 300, and 480 minutes after exposure from rats in the 10 ppm group; 0, 30, 90, 300, 480, and 720 minutes after exposure from rats in the 30 ppm group; and 0, 30, 90, 360, 720, and 960 minutes after exposure from rats in the 60 ppm group. Up to three males and three females were evaluated at each time point.

STATISTICAL METHODS**Survival Analyses**

The probability of survival was estimated by the product-limit procedure of Kaplan and Meier (1958) and is presented in the form of graphs. A missexed animal was censored from the survival analyses; animals dying from natural causes were not censored. Statistical analyses for possible dose-related effects on survival used Cox's (1972) method for testing two groups for equality and Tarone's (1975) life table test to identify dose-related trends. All reported P values for the survival analyses are two sided.

Calculation of Incidence

The incidences of neoplasms or nonneoplastic lesions are presented in Tables A1, A5, B1, and B5 as the

numbers of animals bearing such lesions at a specific anatomic site and the numbers of animals with that site examined microscopically. For calculation of statistical significance, the incidences of most neoplasms (Tables A3 and B3) and all nonneoplastic lesions are given as the numbers of animals affected at each site examined microscopically. However, when macroscopic examination was required to detect neoplasms in certain tissues (e.g., harderian gland, intestine, mammary gland, and skin) before microscopic evaluation, or when neoplasms had multiple potential sites of occurrence (e.g., leukemia or lymphoma), the denominators consist of the number of animals on which a necropsy was performed. Tables A3 and B3 also give the survival-adjusted neoplasm rate for each group and each site-specific neoplasm. This survival-adjusted rate (based on the Poly-3 method described below) accounts

for differential mortality by assigning a reduced risk of neoplasm, proportional to the third power of the fraction of time on study, to animals that do not reach terminal sacrifice.

Analysis of Neoplasm and Nonneoplastic Lesion Incidences

The Poly-k test (Bailer and Portier, 1988; Portier and Bailer, 1989; Piegorsch and Bailer, 1997) was used to assess neoplasm and nonneoplastic lesion prevalence. This test is a survival-adjusted quantal-response procedure that modifies the Cochran-Armitage linear trend test to take survival differences into account. More specifically, this method modifies the denominator in the quantal estimate of lesion incidence to approximate more closely the total number of animal years at risk. For analysis of a given site, each animal is assigned a risk weight. This value is one if the animal had a lesion at that site or if it survived until terminal sacrifice; if the animal died prior to terminal sacrifice and did not have a lesion at that site, its risk weight is the fraction of the entire study time that it survived, raised to the kth power.

This method yields a lesion prevalence rate that depends only upon the choice of a shape parameter for a Weibull hazard function describing cumulative lesion incidence over time (Bailer and Portier, 1988). Unless otherwise specified, a value of $k=3$ was used in the analysis of site-specific lesions. This value was recommended by Bailer and Portier (1988) following an evaluation of neoplasm onset time distributions for a variety of site-specific neoplasms in control F344 rats and B6C3F₁ mice (Portier *et al.*, 1986). Bailer and Portier (1988) showed that the Poly-3 test gave valid results if the true value of k was anywhere in the range from 1 to 5. A further advantage of the Poly-3 method is that it does not require lesion lethality assumptions. Variation introduced by the use of risk weights, which reflect differential mortality, was accommodated by adjusting the variance of the Poly-3 statistic as recommended by Bieler and Williams (1993).

Tests of significance included pairwise comparisons of each exposed group with controls and a test for an overall exposure-related trend. Continuity-corrected Poly-3 tests were used in the analysis of lesion incidence, and reported P values are one sided. The significance of lower incidences or decreasing trends in

lesions are represented as 1-P with the letter N added (e.g., $P=0.99$ is presented as $P=0.01N$).

Analysis of Continuous Variables

Two approaches were employed to assess the significance of pairwise comparisons between exposed and control groups in the analysis of continuous variables. Body weight data, which historically have approximately normal distributions, were analyzed with the parametric multiple comparison procedures of Dunnett (1955) and Williams (1971, 1972). Jonckheere's test (Jonckheere, 1954) was used to assess the significance of the dose-related trends and to determine whether a trend-sensitive test (Williams' test) was more appropriate for pairwise comparisons than a test that does not assume a monotonic dose-related trend (Dunnett's test). Prior to statistical analysis, extreme values identified by the outlier test of Dixon and Massey (1951) were examined by NTP personnel, and implausible values were eliminated from the analysis. Average severity values were analyzed for significance with the Mann-Whitney U test (Hollander and Wolfe, 1973).

Historical Control Data

The concurrent control group represents the most valid comparison to the treated groups and is the only control group analyzed statistically in NTP bioassays. However, historical control data are often helpful in interpreting potential treatment-related effects, particularly for uncommon or rare neoplasm types. For meaningful comparisons, the conditions for studies in the historical database must be generally similar. Until recently, the NTP historical control database consisted of animals fed NIH-07 diet. In 1995, the NTP changed the diet fed to animals used in toxicity and carcinogenesis studies conducted by the NTP. This new diet (NTP-2000) contains less protein and more fiber and fat than the NIH-07 diet previously used (Rao, 1996, 1997). This dietary change was instituted primarily to increase longevity and decrease the incidence and/or severity of some spontaneous neoplastic and nonneoplastic lesions in the rats and mice used in NTP studies. This study of naphthalene is one of the first in which the animals on study were fed the NTP-2000 diet. Because the incidence of some neoplastic and nonneoplastic lesions are affected by the dietary change, use of the existing historical control database (NIH-07) diet is not appropriate for all neoplasm types.

Currently, the number of studies in which the NTP-2000 diet was used is limited. This diet was used in the four studies (indium phosphide, sodium nitrite, *p-p'*-dichlorodiphenyl sulfone, and naphthalene) reported at the May 18, 2000, peer review and in two others (methacrylonitrile and *p*-nitrotoluene) not yet reported. Therefore, a database of incidences of neoplastic lesions was created for this group of six studies. Four routes of administration were used in these six studies: *p*-nitrotoluene and *p-p'*-dichlorodiphenyl sulfone were administered by dosed feed; sodium nitrite was administered in the drinking water; methacrylonitrile was administered by gavage using deionized water; and naphthalene and indium phosphide were administered via whole body inhalation. Based on the extensive NTP historical database using the NIH-07 diet, incidences of the vast majority of spontaneous neoplasms are not significantly different between control groups irrespective of the route of administration. There is no reason to expect this to be different with the NTP-2000 diet. Clearly, control animals from dosed feed and dosed water studies are treated no differently and no differences in incidence of neoplasms are expected. There are some exceptions, and if comparisons are necessary for these neoplasm types, only studies with similar routes of administration will be used.

The set of six studies using the NTP-2000 diet will be the primary historical control group used for comparison. However, where appropriate, the larger historical database (NIH-07 diet) may be used to augment the smaller NTP-2000 database.

QUALITY ASSURANCE METHODS

The 2-year study was conducted in compliance with Food and Drug Administration Good Laboratory Practice Regulations (21 CFR, Part 58). In addition, as records from the 2-year study were submitted to the NTP Archives, this study was audited retrospectively by an independent quality assurance contractor. Separate audits covered completeness and accuracy of the pathology data, pathology specimens, final pathology tables, and a draft of this NTP Technical Report. Audit procedures and findings are presented in the reports and are on file at NIEHS. The audit findings were

reviewed and assessed by NTP staff, and all comments were resolved or otherwise addressed during the preparation of this Technical Report.

GENETIC TOXICOLOGY

The genetic toxicity of naphthalene was assessed by testing the ability of the chemical to induce mutations in various strains of *Salmonella typhimurium* and sister chromatid exchanges and chromosomal aberrations in cultured Chinese hamster ovary cells. The protocols for these studies and the results are given in Appendix C.

The genetic toxicity studies of naphthalene are part of a larger effort by the NTP to develop a comprehensive database that would permit a critical anticipation of a chemical's carcinogenicity in experimental animals based on numerous considerations, including the molecular structure of the chemical and its observed effects in short-term *in vitro* and *in vivo* genetic toxicity tests (structure-activity relationships). These short-term genetic toxicity tests were originally developed to clarify mechanisms of chemical-induced DNA damage growing out of the earlier electrophilicity/mutagenicity relationship proposed by Miller and Miller (1977) and the somatic mutation theory of cancer (Straus, 1981; Crawford, 1985). Therefore, the information obtained from these tests applies only to mutagenic carcinogens.

For mutagenic carcinogens, the combination of DNA reactivity and *Salmonella* mutagenicity is highly correlated with the induction of carcinogenicity in multiple species and genders of rodents and at multiple tissue sites (Ashby and Tennant, 1991). Data from NTP studies show that a positive response in *Salmonella* is the most predictive *in vitro* test for rodent carcinogenicity (89% of the *Salmonella* mutagens are rodent carcinogens) and that there is no complementarity among the *in vitro* genetic toxicity tests (Tennant *et al.*, 1987; Zeiger *et al.*, 1990). That is, no battery of tests that included the *Salmonella* test improved the predictivity of the *Salmonella* test alone. Although other *in vitro* genetic toxicity tests correlate less well with rodent carcinogenicity compared with the *Salmonella* test, these other tests can provide useful information on the types of DNA and chromosomal effects induced by the chemical under investigation.

RESULTS

2-YEAR STUDY

Survival

Estimates of 2-year survival probabilities for male and female rats are shown in Table 3 and in the Kaplan-Meier survival curves (Figure 2). Survival of all exposed groups of male and female rats was similar to that of the chamber controls.

Body Weights and Clinical Findings

Mean body weights of male and female rats are given in Figure 3 and Tables 4 and 5. Mean body weights of all exposed groups of male rats were less than those of the chamber control group throughout most of the study. Mean body weights of exposed groups of females were generally similar to those of the chamber controls. There were no clinical findings related to naphthalene exposure.

TABLE 3
Survival of Rats in the 2-Year Inhalation Study of Naphthalene

	Chamber Control	10 ppm	30 ppm	60 ppm
Male				
Animals initially in study	49	49	49	49
Missexed ^a	0	0	1	0
Moribund	21	22	19	25
Natural deaths	4	5	6	3
Animals surviving to study termination	24	22	23	21
Percent probability of survival at end of study ^b	49	45	48	43
Mean survival (days) ^c	681	669	674	649
Survival analysis ^d	P=0.433	P=0.702	P=0.880	P=0.414
Female				
Animals initially in study	49	49	49	49
Moribund	18	22	16	21
Natural deaths	3	6	5	4
Animals surviving to study termination	28	21	28	24
Percent probability of survival at end of study	57	43	57	49
Mean survival (days)	700	669	681	656
Survival analysis	P=0.572	P=0.127	P=0.892	P=0.277

^a Censored from survival analyses

^b Kaplan-Meier determinations

^c Mean of all deaths (uncensored, censored, and terminal sacrifice)

^d The result of the life table trend test (Tarone, 1975) is in the chamber control column, and the results of the life table pairwise comparisons (Cox, 1972) with the chamber controls are in the exposed group columns.

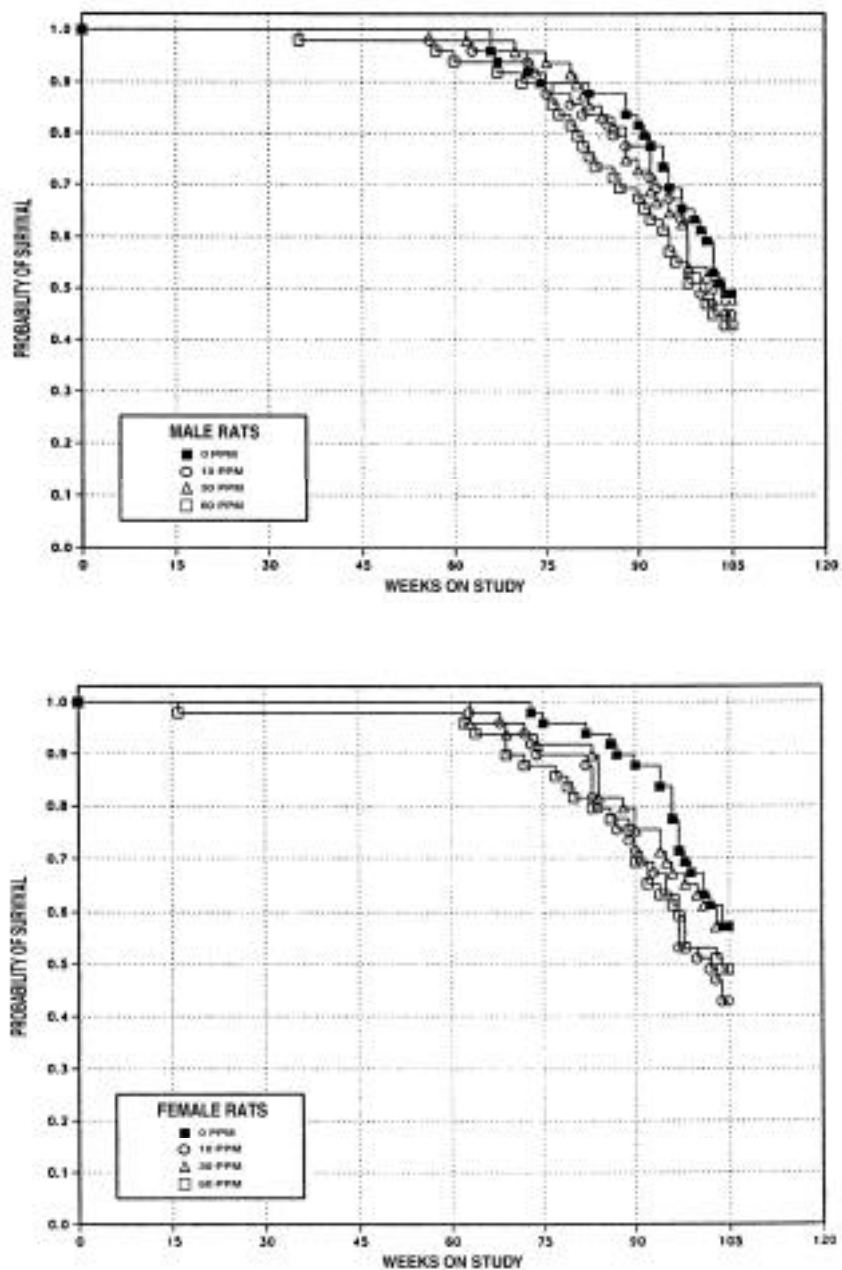

Figure 2
Kaplan-Meier Survival Curves for Male and Female Rats
Exposed to Naphthalene by Inhalation for 2 Years

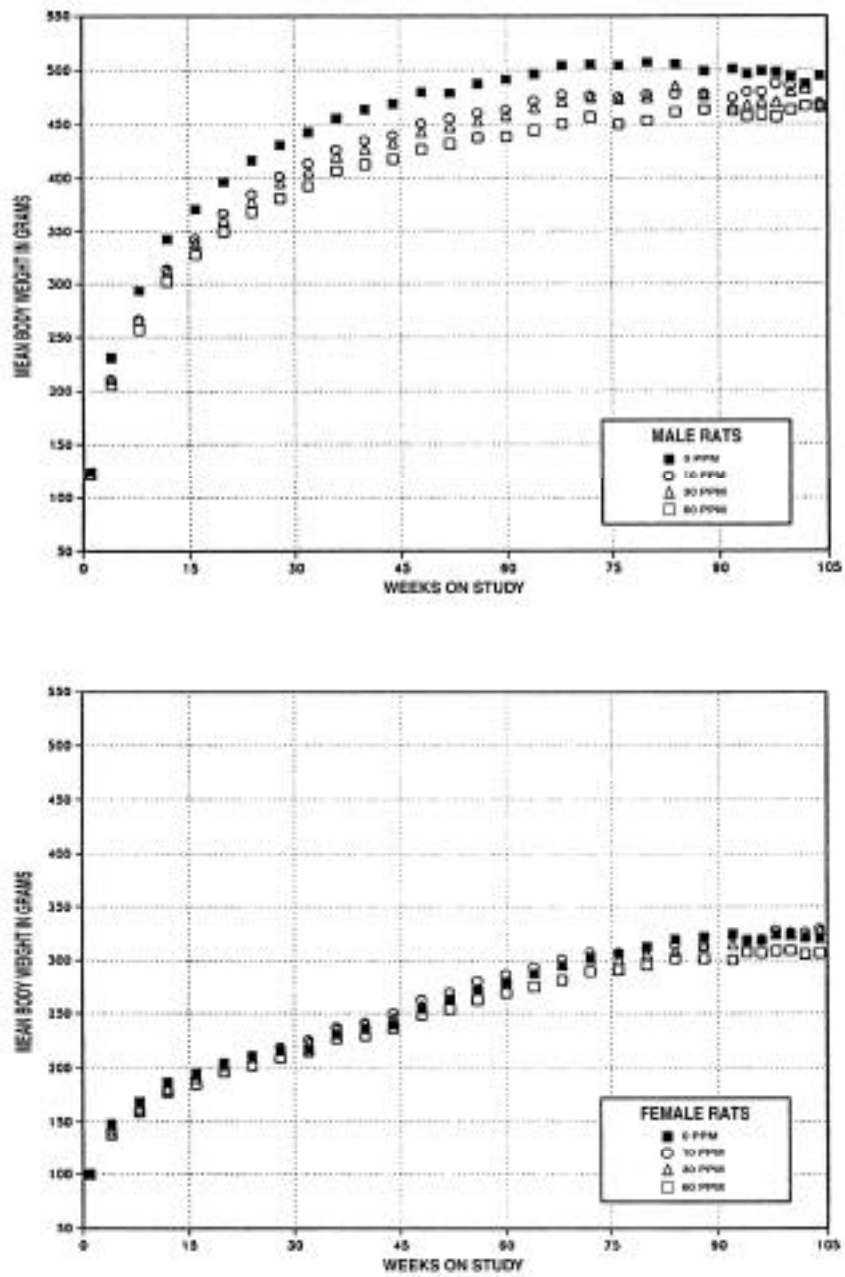

Figure 2
Growth Curves for Male and Female Rats Exposed to Naphthalene
by Inhalation for 2 Years

TABLE 4
Mean Body Weights and Survival of Male Rats in the 2-Year Inhalation Study of Naphthalene

Weeks on Study	Chamber Control		10 ppm			30 ppm			60 ppm		
	Av. Wt. (g)	No. of Survivors	Av. Wt. (g)	Wt. (% of controls)	No. of Survivors	Av. Wt. (g)	Wt. (% of controls)	No. of Survivors	Av. Wt. (g)	Wt. (% of controls)	No. of Survivors
1	125	49	122	98	49	123	98	48	122	98	49
4	231	49	211	91	49	211	91	48	206	89	49
8	293	49	267	91	49	267	91	48	257	88	49
12	343	49	314	92	49	312	91	48	302	88	49
16	371	49	343	92	49	339	91	48	328	88	49
20	396	49	367	93	49	361	91	48	350	88	49
24	416	49	385	92	49	378	91	48	368	88	49
28	431	49	401	93	49	396	92	48	381	89	49
32	443	49	414	93	49	406	92	48	393	89	49
36	455	49	426	94	49	420	92	48	407	89	48
40	464	49	435	94	49	427	92	48	412	89	48
44	469	49	439	94	49	433	92	48	418	89	48
48	480	49	451	94	49	443	93	48	427	89	48
52	479	49	455	95	49	448	94	48	432	90	48
56	488	49	461	94	48	453	93	48	438	90	48
60	492	49	463	94	48	458	93	48	438	89	47
64	496	49	471	95	47	465	94	47	444	90	46
68	505	46	477	95	47	472	93	47	450	89	45
72	506	45	477	94	46	475	94	46	457	90	44
76	505	44	475	94	43	474	94	45	450	89	42
80	507	44	478	94	42	475	94	44	453	89	40
84	505	43	478	95	41	485	96	40	462	91	36
88	499	43	479	96	39	477	96	37	463	93	34
92	501	38	475	95	38	467	93	35	462	92	31
94	496	38	480	97	34	468	94	32	457	92	31
96	499	34	480	96	33	471	94	31	459	92	28
98	498	32	488	98	26	470	94	28	457	92	27
100	494	30	485	98	25	480	97	26	463	94	25
102	488	27	483	99	24	483	99	24	467	96	22
104	495	24	469	95	22	468	95	24	466	94	21
Mean for weeks											
1-13	248		229	92		228	92		222	90	
14-52	440		412	94		405	92		392	89	
53-104	498		476	96		471	95		455	91	

TABLE 5
Mean Body Weights and Survival of Female Rats in the 2-Year Inhalation Study of Naphthalene

Weeks on Study	Chamber Control		10 ppm			30 ppm			60 ppm		
	Av. Wt. (g)	No. of Survivors	Av. Wt. (g)	Wt. (% of controls)	No. of Survivors	Av. Wt. (g)	Wt. (% of controls)	No. of Survivors	Av. Wt. (g)	Wt. (% of controls)	No. of Survivors
1	100	49	101	101	49	100	100	49	100	100	49
4	148	49	141	95	49	139	93	49	138	93	49
8	169	49	162	96	49	160	95	49	159	94	49
12	187	49	180	96	49	180	96	49	177	95	49
16	195	49	191	98	49	190	98	49	185	95	49
20	204	49	203	99	49	202	99	49	196	96	48
24	211	49	211	100	49	210	99	49	202	96	48
28	216	49	219	102	49	218	101	49	210	97	48
32	217	49	226	104	49	224	103	49	215	99	48
36	231	49	237	103	49	237	102	49	227	98	48
40	236	49	242	103	49	241	102	49	230	98	48
44	240	49	250	104	49	246	103	49	237	99	48
48	254	49	262	103	49	257	101	49	249	98	48
52	262	49	270	103	49	264	101	49	254	97	48
56	272	49	280	103	49	273	101	49	263	97	48
60	279	49	287	103	49	281	101	49	269	97	48
64	287	49	294	102	48	288	100	47	276	96	46
68	295	49	301	102	47	296	100	47	282	96	46
72	303	49	307	101	47	302	100	46	289	96	44
76	306	47	307	100	44	301	98	45	291	95	43
80	313	47	310	99	44	306	98	45	296	95	40
84	320	46	314	98	40	309	97	43	302	94	39
88	322	44	314	98	37	314	98	40	302	94	38
92	325	43	322	99	34	315	97	37	300	92	33
94	319	43	318	100	33	317	99	35	308	97	31
96	319	41	318	100	31	320	100	34	307	96	30
98	325	34	329	101	26	324	100	33	309	95	27
100	325	33	327	101	26	324	100	32	309	95	26
102	321	31	326	102	25	324	101	30	306	95	26
104	320	29	330	103	21	329	103	28	307	96	24
Mean for weeks											
1-13	151		146	97		145	96		144	95	
14-52	227		231	102		229	101		221	97	
53-104	309		312	101		308	100		295	95	

Gross Observations

Malignant nasal neoplasms were observed in several male and female rats. These masses frequently partially occluded the nasal passages or obliterated the normal architecture of the nasal turbinates and, in some affected animals, invaded the brain.

Pathology and Statistical Analyses

This section describes the statistically significant or biologically noteworthy changes in the incidences of neoplasms and nonneoplastic lesions of the nose and lung. Summaries of the incidences of neoplasms and nonneoplastic lesions, individual animal tumor diagnoses, statistical analyses of primary neoplasms that occurred with an incidence of at least 5% in at least one animal group, and historical incidences for the neoplasms mentioned in this section are presented in Appendix A for male rats and Appendix B for female rats.

Nose: Increased incidences of a variety of neoplasms and nonneoplastic lesions occurred in the nose of exposed male and female rats. These lesions were observed in all three levels of the nasal cavity that are routinely examined in NTP toxicity and carcinogenicity studies: level I, excised immediately posterior to the upper incisor teeth; level II, excised through the level of the incisive papilla anterior to the first palatal ridge; and level III, excised through the middle of the second molar teeth. Levels I and II contain the naso- and maxilloturbinates that along with the nasal passages (meatuses) and septum are lined by ciliated respiratory-type epithelium. Level III encompasses the olfactory region of the nose with ethmoid turbinates and meatuses lined entirely by specialized olfactory neuroepithelium. Neuroblastomas of the olfactory epithelium occurred in males exposed to 30 or 60 ppm and in all exposed groups of females (Tables 6, A3, and B3). The incidences of neuroblastoma occurred with positive trends in males and females, and the incidence in females exposed to 60 ppm was significantly greater than that in the chamber controls. Neuroblastomas have not been observed in male or female chamber control rats in the database for animals fed NIH-07 feed in 2-year inhalation studies or in the more recent, smaller database for control rats fed NTP-2000 feed (Tables 6, A4, and B4).

Neuroblastomas were variably sized, unilateral or bilateral invasive masses that arose in Level III of the

nasal cavity and extended into Levels II and I. Larger masses occluded the nasal passages and often obliterated the nasal architecture invading nerves, nasal bones, and the cribriform plate (Plate 1). Other masses extended along the mucosa and replaced the epithelium of the turbinates and nasal septum (Plate 2). The morphology of the neuroblastomas varied. Component neoplastic cells were round, polygonal, or spindle-shaped and arranged in variably sized, irregular islands, cords, and rosettes separated by fibrovascular stroma (Plate 3). In other masses, component cells were arranged in a glandular pattern. Some cells had scant eosinophilic to amphophilic cytoplasm with pale oval to polygonal vesicular nuclei and prominent central nucleoli; others had abundant cytoplasm and elongate, intensely basophilic nuclei. Small nests of neoplastic cells were present in the lamina propria of the turbinates and nasal septum, and in olfactory nerve bundles. A few neoplasms had focal irregular areas of squamous metaplasia, sometimes extensive with formation of keratin pearls. Variably sized focal areas of coagulative necrosis were also observed in most neuroblastomas. Mitotic figures were abundant. Neoplasms that invaded the cribriform plate extended into the olfactory lobes of the brain (Plate 4). One male each in the 30 and 60 ppm groups had metastases in the lungs (Table A1).

The incidences of adenoma of the respiratory epithelium occurred with a positive trend in male rats and were significantly increased in all exposed groups; the incidences in female rats exposed to 30 or 60 ppm were also increased, but not significantly (Tables 6, A3, and B3). Nasal adenomas have not been observed in male or female chamber control rats in the database for animals fed NIH-07 feed in 2-year inhalation studies or in the more recent, smaller database for control rats fed NTP-2000 feed (Tables 6, A4, and B4). Adenomas arose from the respiratory and transitional epithelia of Levels I and II of the nasal cavity along the medial or lateral aspects or tips of the nasoturbinates or the lateral wall. They were irregular exophytic, polypoid, pedunculated or broad-based sessile masses that varied in size and sometimes partially occluded the nasal passages (Plates 5 and 6). Component neoplastic cells were well-differentiated, simple to cuboidal to columnar and arranged primarily as variably sized glands surrounded by scant fibrovascular stroma with few focal solid areas of cells (Plate 7). In some masses, the epithelium appeared to be pseudostratified. The glands were

TABLE 6
Incidences of Neoplasms and Nonneoplastic Lesions of the Nose in Rats in the 2-Year Inhalation Study of Naphthalene

	Chamber Control	10 ppm	30 ppm	60 ppm
Male				
Number Examined Microscopically	49	49	48	48
Olfactory Epithelium, Hyperplasia, Atypical ^a	0	48** (2.1) ^b	45** (2.5)	46** (3.0)
Olfactory Epithelium, Atrophy	3 (1.3)	49** (2.1)	48** (2.8)	47** (3.5)
Olfactory Epithelium, Inflammation, Chronic	0	49** (2.0)	48** (2.2)	48** (3.0)
Olfactory Epithelium, Degeneration, Hyaline	3 (1.3)	46** (1.7)	40** (1.7)	38** (1.5)
Respiratory Epithelium, Hyperplasia	3 (1.0)	21** (2.2)	29** (2.0)	29** (2.2)
Respiratory Epithelium, Metaplasia, Squamous	0	15** (2.1)	23** (2.0)	18** (1.8)
Respiratory Epithelium, Degeneration, Hyaline	0	20** (1.2)	19** (1.4)	19** (1.2)
Goblet Cell, Respiratory Epithelium, Hyperplasia	0	25** (1.3)	29** (1.2)	26** (1.2)
Glands, Hyperplasia	1 (1.0)	49** (2.2)	48** (2.9)	48** (3.5)
Glands, Metaplasia, Squamous	0	3 (3.0)	14** (2.1)	26** (2.5)
Respiratory Epithelium, Adenoma ^c				
Overall rate ^d	0/49 (0%)	6/49 (12%)	8/48 (17%)	15/48 (31%)
Adjusted rate ^e	0.0%	15.3%	20.6%	38.1%
Terminal rate ^f	0/24 (0%)	5/22 (23%)	7/23 (30%)	7/21 (33%)
First incidence (days)	— ^h	684	685	552
Poly-3 test ^g	P<0.001	P=0.013	P=0.003	P<0.001
Olfactory Epithelium, Neuroblastoma ^c				
Overall rate	0/49 (0%)	0/49 (0%)	4/48 (8%)	3/48 (6%)
Adjusted rate	0.0%	0.0%	10.1%	7.7%
Terminal rate	0/24 (0%)	0/22 (0%)	2/23 (9%)	0/21 (0%)
First incidence (days)	—	— ⁱ	433	399
Poly-3 test	P=0.027	—	P=0.056	P=0.109
Female				
Number Examined Microscopically	49	49	49	49
Olfactory Epithelium, Hyperplasia, Atypical	0	48** (2.0)	48** (2.4)	43** (2.9)
Olfactory Epithelium, Atrophy	0	49** (1.9)	49** (2.7)	47** (3.2)
Olfactory Epithelium, Inflammation, Chronic	0	47** (1.9)	47** (2.6)	45** (3.4)
Olfactory Epithelium, Degeneration, Hyaline	13 (1.1)	46** (1.8)	49** (2.1)	45** (2.1)
Respiratory Epithelium, Hyperplasia	0	18** (1.6)	22** (1.9)	23** (1.7)
Respiratory Epithelium, Metaplasia, Squamous	0	21** (1.6)	17** (1.5)	15** (1.8)
Respiratory Epithelium, Degeneration, Hyaline	8 (1.0)	33** (1.2)	34** (1.4)	28** (1.2)
Goblet Cell, Respiratory Epithelium, Hyperplasia	0	16** (1.0)	29** (1.2)	20** (1.0)
Glands, Hyperplasia	0	48** (1.9)	48** (3.1)	42** (3.3)
Glands, Metaplasia, Squamous	0	2 (2.0)	20** (2.5)	20** (2.8)

TABLE 6
Incidences of Neoplasms and Nonneoplastic Lesions of the Nose in Rats in the 2-Year Inhalation Study of Naphthalene

	Chamber Control	10 ppm	30 ppm	60 ppm
Female (continued)				
Respiratory Epithelium, Adenoma ^c				
Overall rate	0/49 (0%)	0/49 (0%)	4/49 (8%)	2/49 (4%)
Adjusted rate	0.0%	0.0%	9.8%	5.2%
Terminal rate	0/28 (0%)	0/21 (0%)	3/28 (11%)	1/24 (4%)
First incidence (days)	—	—	721	555
Poly-3 test	P=0.066	—	P=0.053	P=0.212
Olfactory Epithelium, Neuroblastoma ^c				
Overall rate	0/49 (0%)	2/49 (4%)	3/49 (6%)	12/49 (24%)
Adjusted rate	0.0%	5.1%	7.2%	28.2%
Terminal rate	0/28 (0%)	0/21 (0%)	1/28 (4%)	3/24 (13%)
First incidence (days)	—	679	480	429
Poly-3 test	P<0.001	P=0.214	P=0.112	P<0.001

** Significantly different ($P \leq 0.01$) from the chamber control group by the Poly-3 test

^a Number of animals with lesion

^b Average severity grade of lesions in affected animals: 1=minimal, 2=mild, 3=moderate, 4=marked

^c Historical incidence for 2-year studies with control groups given NTP-2000 feed: 0/299

^d Number of animals with neoplasm per number of animals with organ examined microscopically

^e Poly-3 estimated neoplasm incidence after adjustment for intercurrent mortality

^f Observed incidence at terminal kill

^g Beneath the chamber control incidence are the P values associated with the trend test. Beneath the exposed group incidence are the P values corresponding to pairwise comparisons between the chamber controls and that exposed group. The Poly-3 test accounts for differential mortality in animals that do not reach terminal sacrifice.

^h Not applicable; no neoplasms in animal group

ⁱ Value of statistic cannot be computed.

were often variably distended by luminal accumulations of proteinaceous secretory material and cellular debris. A few adenomas were composed of less well differentiated cells that were squamoid in morphology; these cells were large, round to polygonal, with scant to moderate amounts of eosinophilic cytoplasm and large round to oval nuclei that contained one or two prominent nucleoli.

In addition to the nasal neoplasms, the incidences of a variety of nonneoplastic lesions in exposed males and females were significantly greater than those in the chamber controls (Tables 6, A5, and B5). These lesions included atypical (basal cell) hyperplasia, atrophy, chronic inflammation, and hyaline degeneration of the olfactory epithelium; hyperplasia, squamous metaplasia, hyaline degeneration, and goblet cell hyperplasia

of the respiratory epithelium; and glandular hyperplasia and squamous metaplasia. In general, the severities of olfactory epithelial and glandular lesions increased with increasing exposure concentration.

Atypical hyperplasia of the olfactory epithelium occurred primarily along the nasal septum of the ethmoid region. Atypical hyperplasia consisted of disorganization of olfactory epithelium with proliferation of nests of sensory cells within or beneath the epithelium and multifocal nodular proliferations of basal cells, which extended into the submucosa (Plate 8). Atrophy of olfactory epithelium was characterized by a decrease in the height of the epithelium lining the dorsal meatuses of Level II and the ethmoid turbinates of Level III due to variable loss of epithelial cells (Plate 9). Mild atrophy consisted of only loss of

sustentacular cells. Moderate atrophy consisted of loss of mostly sustentacular cells; however, there was also loss of olfactory neurons. In the most severe cases, there was complete loss of sustentacular cells and neurons, leaving only basal epithelial cells. Frequently, ciliated columnar cells replaced normal olfactory epithelium. Although included in the spectrum of changes diagnosed as olfactory epithelial atrophy, the latter alteration is often classified as respiratory epithelial metaplasia. Chronic inflammation of the olfactory region consisted of infiltrates of primarily mononuclear inflammatory cells within the lamina propria invariably accompanied by fibrosis (Plate 10). In affected sites, there was often synechia between adjacent turbinates.

Respiratory epithelial hyperplasia involved the lateral wall and medial surface of the naso- and maxilloturbinates, and was mostly focal to segmental but sometimes involved most of the turbinate extending onto the lateral wall in Levels I and II of the nasal cavity. The affected epithelia appeared thickened by increased numbers of disorganized, often pseudostratified, epithelial cells (Plate 11); component epithelial cells were non-ciliated flattened, or ciliated cuboidal to columnar ciliated. Frequently, the hyperplastic ciliated epithelium was folded in rugose fashion sometimes extending into the submucosa forming pseudoglands, or was continuous with the epithelium of submucosal glands. Respiratory epithelial squamous metaplasia involved the lateral surfaces of the nasoturbinates and the lateral wall in Level I of the nasal cavity. Metaplasia consisted of replacement of the normally ciliated respiratory epithelium by one to six layers of polygonal cells with flattening of the more superficial cells (Plate 12). Keratinization was seldom noted.

Glandular hyperplasia primarily affected the Bowman's glands of the nasal septum, in the dorsal meatus, and ethmoid turbinates in Level III of the nasal cavity. Hyperplasia consisted of proliferation of glands that were frequently enlarged or distended with cell debris and proteinaceous material (Plate 13). Frequently, affected glands were lined by hyperplastic ciliated epithelium that was continuous with that of the mucosa. The hyperplastic cells were often distended by intracytoplasmic protein or protein globules. Squamous metaplasia of glands often accompanied hyperplasia. It was characterized by replacement of the normal epithelial lining by several layers of nonkeratinized squamous cells that often obliterated the glandular lumen.

Goblet cell hyperplasia was generally of minimal severity and primarily involved the respiratory epithelium of the nasal septum in Level I of the nasal cavity. Goblet cells were increased in number, were swollen with mucus, and often formed in small gland-like clusters within the mucosal epithelium (Plate 14). Hyaline degeneration was a focal or multifocal, minimal to mild change that affected both the respiratory and olfactory epithelia. Affected epithelial cells were swollen by intracytoplasmic homogenous, brightly eosinophilic globules (Plate 15). These globules are commonly observed in aging animals, and the severity may increase with age. In chronic inhalation studies, the incidence and severity of this change are often exacerbated in an exposure-dependent manner. Goblet cell hyperplasia and hyaline degeneration are considered nonspecific protective or adaptive responses to chronic inhalation of irritants.

Lung: The incidences of alveolar epithelial hyperplasia in all exposed groups of female rats were greater than that in the chamber controls (chamber control, 4/49; 10 ppm, 11/49; 30 ppm, 11/49; 60 ppm, 9/49; Table B5); the increased incidences in the 10 and 30 ppm groups were significant. However, in male rats, the incidences of hyperplasia were significantly decreased in the 10 and 30 ppm groups (23/49, 12/49, 9/48, 16/49; Table A5). The incidences of minimal chronic inflammation of the lungs were significantly increased in male rats exposed to 10 or 60 ppm (2/49, 13/49, 6/48, 15/49; Table A5). The incidences of lung neoplasms were not affected in exposed males (2/49, 3/49, 1/48, 0/49; Table A3) or females (1/49, 0/49, 0/49, 0/49; Table B1). Chronic inflammation consisted of small focal interstitial and intra-alveolar collections of varying numbers of macrophages, neutrophils, and lymphocytes along with minimal interstitial fibrosis. Mixed with the inflammatory cells were multinucleated giant cells, cell debris, and cholesterol clefts. This change occurred subpleurally and/or at the tips of lung lobes. Such minimal inflammatory foci are often found in chamber control rats, as they were in this study. Although the incidences of chronic inflammation were increased in groups exposed to naphthalene, it was not clear whether this change was exposure related.

Thyroid Gland: The incidences of C-cell adenoma or carcinoma (combined) decreased with increasing exposure concentration in female rats (7/47, 6/46, 4/48, 1/48; Table B3). A similar, but not statistically

significant, decrease was seen in males (chamber control, 10/46; 10 ppm, 8/47; 30 ppm, 5/45; 60 ppm, 5/47; Table A3). These slight differences were not considered biologically significant.

Toxicokinetic Results and Model

A physiologically based pharmacokinetic model representing the uptake, distribution, and metabolism of naphthalene in rats and mice was developed to describe the processes involved in naphthalene toxicokinetics (Appendix D). The model (Figure D1), which is diffusion limited (Kohn, 1997), contains compartments for arterial and venous blood, alveolar space, and tissue and capillary spaces for the lung, liver, kidney, fat and other organs. The compartment for other organs represents both slowly and rapidly perfused tissues (e.g., skin, muscle, bone, heart, and brain). Inhalation of naphthalene from the exposure chamber atmosphere takes place through the alveolar space into the lung. Uptake is modeled as being dependent on the ventilation rate of the animal, permeability of the tissue, and blood flow through the lung. The primary sites for naphthalene metabolism were assumed to be the lung and the liver. One metabolic pathway was modeled in the lung, while in the liver, two pathways were taken into account, one represented by Michaelis-Menten kinetics and the other by Hill kinetics. All the physiological parameters (ventilation rate, cardiac output, tissue volumes, capillary volumes, and blood flow rates to the tissues) used in this model were based on values obtained from the literature and scaled to the body weights of core study rats. Partition coefficients for the different tissues were calculated from the log of the octanol:water partition coefficient. Metabolic rates and permeability constants were estimated by optimizing the model to the available naphthalene blood time-course data. Goodness of fit was evaluated using a maximum-likelihood ratio test.

According to the model, naphthalene is rapidly taken up into the blood as a result of a high blood:air partition coefficient. Metabolism capacity in the lungs seems to

be the same between male and female rats and between male and female mice, and the saturation level is equal for male and female rats. However, saturation of metabolism occurs at lower naphthalene blood concentrations in the female mouse than in the male mouse. The liver metabolic pathway represented by the Michaelis-Menten equation shows equal metabolic capacity and saturation level in male and female rats. However, both the metabolic capacity and saturation level are lower in female mice than in male mice. The second liver metabolic pathway, characterized by a Hill equation with a Hill exponent of 2, again shows equal metabolic capacity and saturation level for male and female rats. In mice, the Hill interpretation found that the metabolic capacity is the same for males and females, but the saturation level is lower for females.

Based on the available blood time-course data for naphthalene alone, no conclusions could be reached on which metabolites may be responsible for naphthalene toxicity.

GENETIC TOXICOLOGY

Naphthalene (0.3 to 100 $\mu\text{g}/\text{plate}$) was not mutagenic in *Salmonella typhimurium* strains TA98, TA100, TA1535, or TA1537, with or without induced rat or hamster liver S9 activation enzymes (Table C1; Mortelmans *et al.*, 1986). In contrast to these negative results for gene mutation induction in bacteria, naphthalene was positive for induction of chromosomal effects in mammalian cells *in vitro*. In cultured Chinese hamster ovary cells, naphthalene induced dose-related increases in sister chromatid exchanges, with and without rat liver S9 activation enzymes (Table C2). In addition, chromosomal aberrations were induced by naphthalene in cultured Chinese hamster ovary cells (Table C3). A strong dose-related increase in the percentage of aberrant cells was observed over a concentration range of 30 to 67.5 $\mu\text{g}/\text{mL}$ naphthalene in the presence of S9, but no significant increases in chromosomal aberrations were seen without S9.



Plate 1

Neuroblastoma (arrows), Level III nasal cavity from a female rat exposed to 30 ppm Naphthalene by inhalation for 2 years. The neoplasm bilaterally obliterates the nasal architecture. H&E; 10X.



Plate 2

Neuroblastoma, Level III nasal cavity from a female rat exposed to 60 ppm naphthalene by inhalation for 2 years. The neoplasm extends along and thickens mucosa of the ethmoid turbinate (arrows). Note normal olfactory epithelium (arrowheads) lining the opposite side of the turbinate. H&E; 10X.

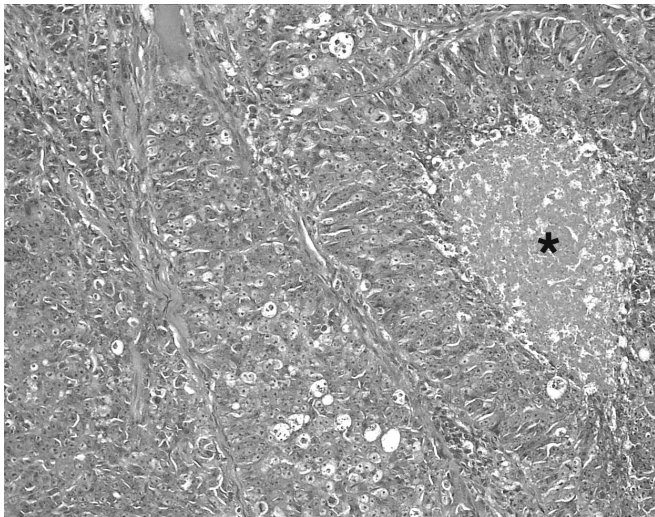

Plate 3

Higher magnification of Plate 1. The neoplastic cells are arranged in irregular lobules of variable size. Mitotic cells are abundant. Note focal area of necrosis (asterisk) within a lobule. H&E; 40X.

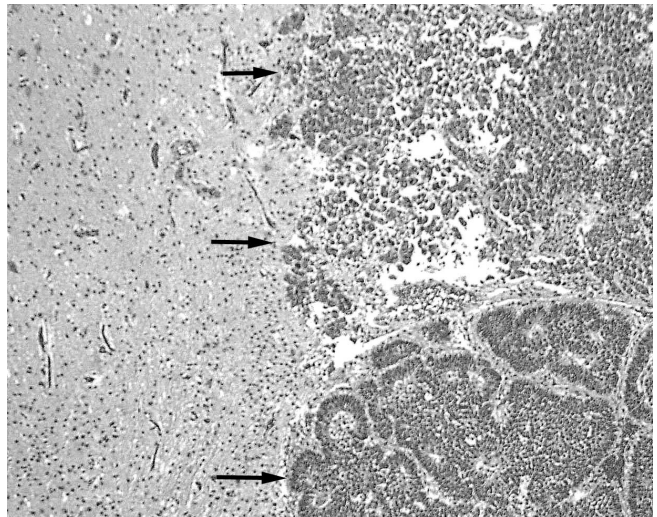

Plate 4

Neuroblastoma (arrows) invading the olfactory lobe of the brain from a female rat exposed to 60 ppm Naphthalene for 2 years. Neuropil of the olfactory lobe is at right. H&E; 10X.

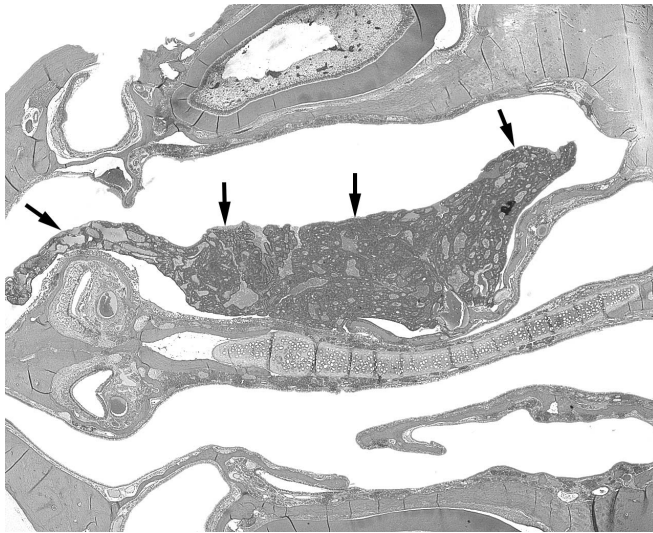

Plate 5

Large respiratory epithelial adenoma (arrows) within the nasal passages, Level I nasal cavity from a male rat exposed to 10 ppm Naphthalene by inhalation for 2 years. H&E; 10X.

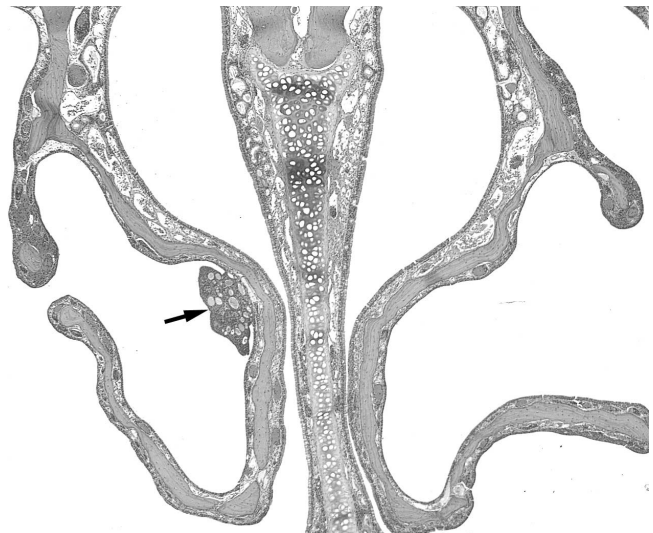

Plate 6

Small respiratory epithelial adenoma (arrow) within the nasal passages, Level I nasal cavity from a male rat exposed to 10 ppm Naphthalene by inhalation for 2 years. H&E; 20X.

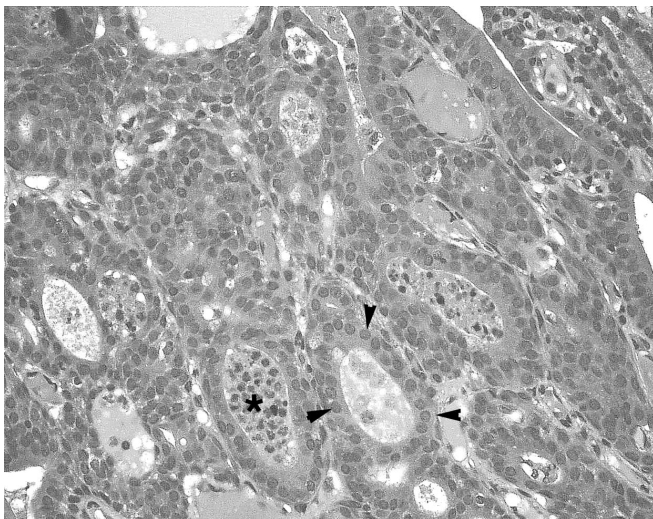

Plate 7

Higher magnification of Plate 5. Component cells are arranged in glands lined by cuboidal epithelial cells (arrowheads). Note cellular debris (asterisk) in the lumen of one gland. H&E; 40X

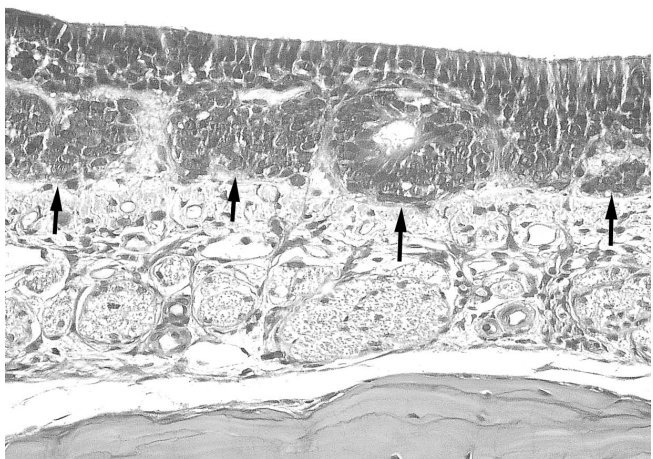

Plate 8

Atypical (basal cell) hyperplasia (arrows) of the olfactory epithelium, Level III nasal cavity from a female rat exposed to 60 ppm Naphthalene by inhalation for 2 years. The hyperplastic basal cells form small nodules that extend into the submucosa. H&E; 40X.

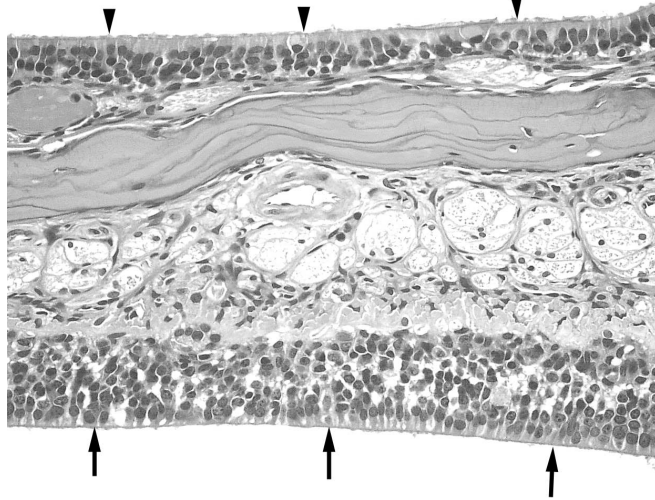

Plate 9

Atrophy (arrowheads) of the olfactory epithelium lining an ethmoid turbinate, Level III nasal cavity from a female rat exposed to 30 ppm Naphthalene for 2 years. The height of the epithelium is reduced due to loss of epithelial cells. Note normal olfactory epithelium (arrows) on the opposite side of the turbinate. H&E; 40X.

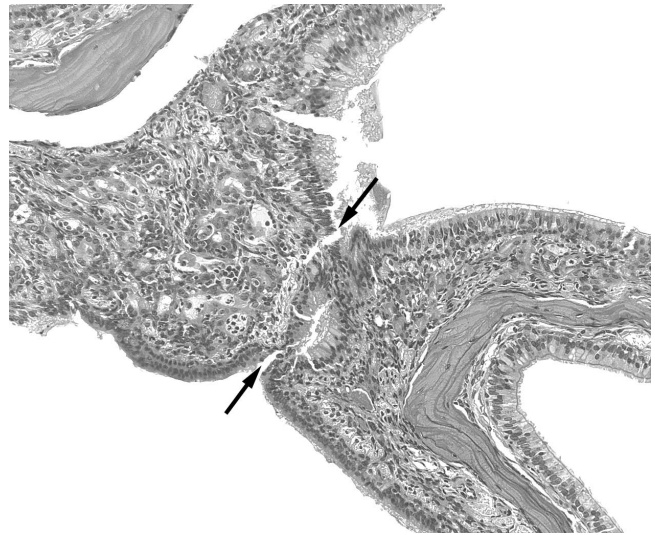

Plate 10

Chronic inflammation in the olfactory epithelium with synechia (arrows) of adjacent ethmoid turbinates, Level III nasal cavity from a female rat exposed to 60 ppm Naphthalene for 2 years. H&E; 20X.

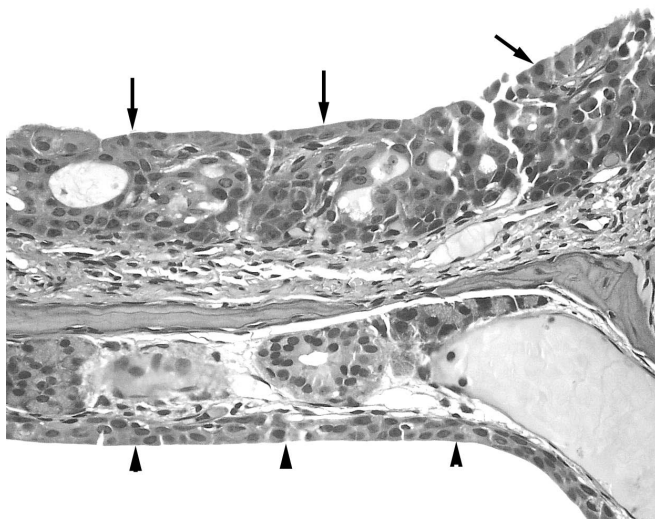

Plate 11

Maxilloturbinate with respiratory epithelial hyperplasia (arrows), Level II nasal cavity from a male rat exposed to 30 ppm Naphthalene for 2 years. The affected epithelium is thickened by several disorganized layers of hyperplastic epithelial cells. Note normal respiratory epithelium (arrowheads) on the opposite side of the turbinate. H&E; 40X.

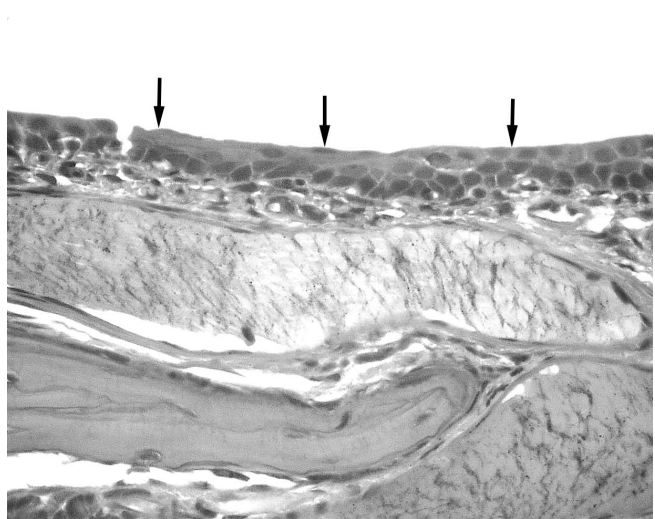

Plate 12

Squamous metaplasia (arrows) of the respiratory epithelium, Level II nasal cavity from a female rat exposed to 30 ppm Naphthalene. H&E; 40X.

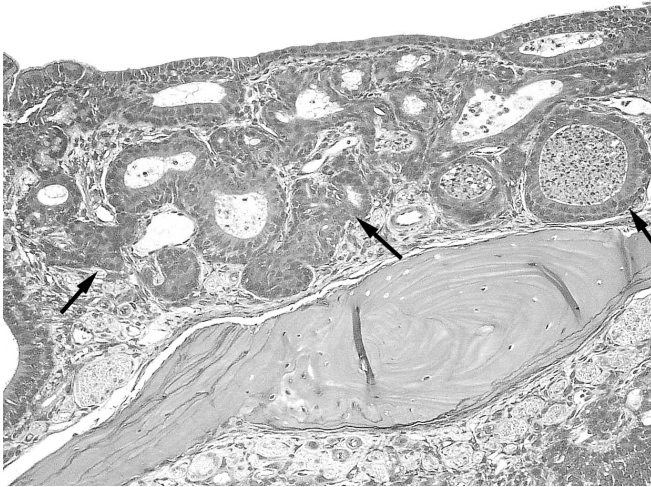

Plate 13

Focal Bowman's gland hyperplasia and squamous metaplasia (arrows), Level III nasal cavity from a female rat exposed to 30 ppm Naphthalene for 2 years. The majority of the glands are lined by non-keratinized squamous epithelium. Many glands are dilated and contain cellular debris and proteinaceous secretion. H&E; 20X

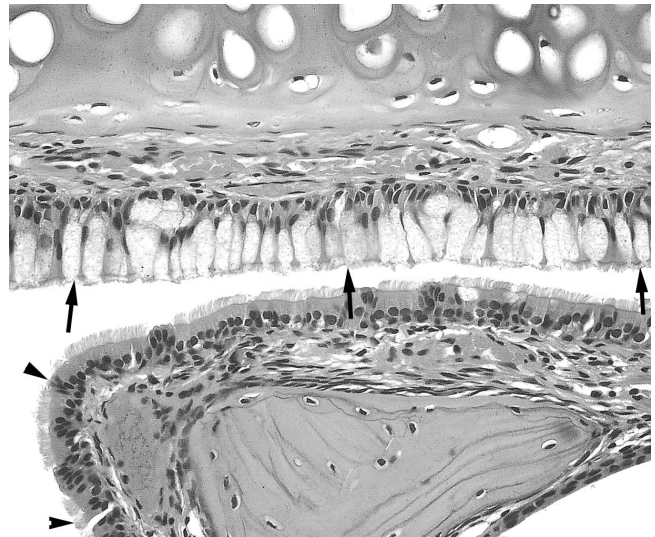

Plate 14

Goblet cell hyperplasia in the respiratory epithelium lining the nasal septum, Level II nasal cavity from a male rat exposed to 10 ppm Naphthalene for 2 years. The epithelium is lined by increased numbers of goblet cells that are swollen with mucus. Note normal respiratory epithelium (arrowheads) lining the maxilloturbinate. H&E; 40 x.

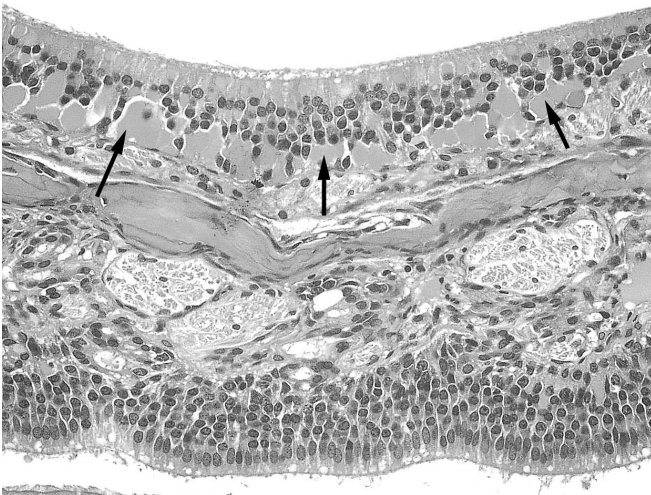

Plate 15

Ethmoid turbinate with hyaline degeneration in the olfactory epithelium, Level III nasal cavity from a male rat exposed to 10 ppm Naphthalene for 2 years. Epithelial cells are distended by hyaline droplets. H&E; 40X.

DISCUSSION AND CONCLUSIONS

Naphthalene, a white crystalline powder, is widely used as moth repellent and chemical intermediate in the synthesis of phthalic acid, naphthylamines, and synthetic resins. The National Institute of Occupational Safety and Health, the Occupational Safety and Health Administration, and the United States Environmental Protection Agency made the original nomination to test naphthalene for carcinogenicity. The nomination was based on the potential for chronic human exposure occupationally or through the use of mothballs in the home and the lack of adequate carcinogenicity studies to determine whether the use of naphthalene should be regulated. Because of the reported lack of carcinogenic activity of naphthalene in an oral rat study by Schmahl (1955), the NTP decided to initially study the carcinogenic potential of naphthalene only in mice. This study was completed and peer reviewed in 1991 (NTP, 1992). Because of the positive carcinogenic response (increased incidences of lung neoplasms in exposed female mice), the peer review panel recommended and the NTP concurred that an inhalation study be conducted in rats. The recommendation was made because previous studies with naphthalene in rats have been conducted via routes other than inhalation (the major route for human exposure) and because the Schmahl (1955) study was considered inadequate due to the small number of animals used (28 rats were dosed once daily, six times per week, until each was administered a total of 10 g over a 700-day period, or about 41 mg/kg per day).

No subchronic study was conducted because rats are considered to be less sensitive to naphthalene toxicity than mice, and mice in the NTP study were exposed to 10 or 30 ppm. The highest exposure concentration used in the current rat study (60 ppm) is the maximum that can be generated without naphthalene condensation. The lowest exposure concentration used equals the threshold limit value for the 8-hour, time-weighted average established by the American Conference of Governmental Industrial Hygienists (ACGIH, 1999). Based on the toxicokinetic model outlined in Appendix D, the daily doses delivered to male and female rats exposed to 0, 10, 30, or 60 ppm in the

current study were estimated to be 0, 3.6 to 3.9, 10.7 to 11.4, and 20.1 to 20.6 mg/kg.

Although naphthalene is a known ocular irritant and a cataractogen (Rathbun *et al.*, 1990; Tao *et al.*, 1991), gross or microscopic evaluation of the eye did not reveal any exposure-related ocular abnormalities in rats in the current study. The absence of a cataractogenic effect in rats in the present study, as compared to rats in the studies conducted by Rathbun *et al.* (1990) and Tao *et al.* (1991), may be explained by the differences in exposure concentrations, route of exposure (oral versus inhalation), and/or the strain of rat used.

The nose was the site of toxicity and carcinogenicity in male and female rats. Neuroblastomas of the olfactory epithelium and adenomas of the respiratory epithelium occurred in exposed male and female rats. Because neither neuroblastomas nor adenomas occurred in the nose of concurrent chamber controls, nor have they been observed in the NTP historical control databases, these neoplasms were considered to be related to naphthalene exposure.

Along with the respiratory and olfactory neoplasms observed in the present study, the incidences of several accompanying nonneoplastic lesions were significantly increased in all exposed groups. These lesions included epithelial and goblet cell hyperplasia, squamous metaplasia, and hyaline degeneration of the respiratory epithelium; atrophy, atypical (basal cell) hyperplasia, inflammation, and hyaline degeneration of the olfactory epithelium; and hyperplasia and squamous metaplasia of the Bowman's glands in the olfactory region of the nose. With the exception of atypical hyperplasia of the olfactory epithelium, some or all of the nonneoplastic lesions observed in this study are commonly observed in NTP inhalation studies with chemicals of an irritant nature and appear to be adaptive responses. In some of these studies, the incidences of these lesions increased with increasing exposure concentration (NTP, 1997, 1998a,b, 1999). In a review of several previous NTP inhalation studies, no incidences of olfactory epithelial atypical (basal cell)

hyperplasia similar to those observed in this study were found. In the present study, the cells involved in this lesion and focal areas of intraepithelial hyperplasia/dysplasia appeared to be morphologically similar to and form a continuum with the neuroblastomas. In the respiratory epithelium, there was no clear association between the morphologies of the nonneoplastic proliferative changes and the development of respiratory epithelial adenomas.

Neuroblastomas of the nasal olfactory epithelium are rare neoplasms in rodents (Pino *et al.*, 1999) and humans (McElroy *et al.*, 1998). Experimentally, however, they have been induced by oral, inhalation, or peritoneal exposure to several structurally unrelated chemicals (Pino *et al.*, 1999). In some of these studies, the induction of nasal neoplasms occurred in conjunction with olfactory epithelial nonneoplastic lesions (squamous and respiratory metaplasia, basal cell hyperplasia, glandular hyperplasia). However, the association between these lesions and the development of neuroblastomas is not clear because in other studies, similar lesions occurred without the development of neuroblastomas (Miller *et al.*, 1985).

Some compounds that require metabolic activation by the cytochrome P450 enzyme system have been shown to cause olfactory epithelial injury, chronic hyperplastic/regenerative lesions, and olfactory neoplasms following oral or inhalation exposure. The type IV phosphodiesterase inhibitor RP 73401 induced nasal neuroblastomas and a spectrum of nonneoplastic lesions in the olfactory epithelium that appeared to be similar to those observed in this study (Pino *et al.*, 1999). No lesions occurred in the respiratory or transitional epithelia of the nasal cavity. The toxicity of RP 73401 was related to metabolic activation in the sustentacular cells of the olfactory epithelium. These cells have especially high concentrations of many metabolizing enzymes, particularly those of the cytochrome P450 (CYP2F) system, and are important sites of xenobiotic metabolism (Harkema and Morgan, 1996; Thornton-Manning and Dahl, 1997). The secretory cells of the respiratory epithelium also contain xenobiotic-metabolizing enzymes, including cytochrome P450 enzymes (Harkema and Morgan, 1996). The metabolism of naphthalene appears to be dependent on the cytochrome P450 enzyme system. The observed nasal toxicity observed in this study may be

related, in part, to the metabolism of naphthalene in the respiratory and olfactory epithelia.

The carcinogenic effect of naphthalene observed in the nose of F344/N rats in the current study contrasts with the lack of carcinogenic effect of naphthalene observed in an earlier study with rats (strain unspecified) (Schmahl, 1955). The lack of concordance in results is likely due to differences in routes of administration (inhalation versus oral), strain of rat used, and, perhaps, the dose to the target tissue. Although some naphthalene would be expected to be eliminated in exhaled breath following oral administration as in the Schmahl (1955) study, the relatively low volatility and the high capacity for metabolism (Appendix D) may have limited the amount of parent compound that came in contact with the nasal tissue of animals in that study.

In a 2-year NTP inhalation study of naphthalene in B6C3F₁ mice, naphthalene was carcinogenic in females exposed to 30 ppm, causing an increased incidence of alveolar/bronchiolar adenoma (NTP, 1992). Two female mice exposed to 10 ppm had adenomas of the nasal respiratory epithelium; these adenomas were not considered to be related to exposure because none were found in females exposed to 30 ppm. In rats, increased incidences of chronic inflammation (males) and alveolar epithelial hyperplasia (females) were the only effects observed in the lung that may have been related to exposure. In mice, increased incidences of minimal to mild focal inflammation and metaplasia of the olfactory epithelium and hyperplasia of the respiratory epithelium occurred in the nose; however, neoplasms of olfactory epithelial origin were not observed.

The difference in sites of neoplasms in rats and mice may be related in part to the difference in anatomy of nasal passages in these two species, which may in turn lead to differences in doses delivered at this site. Swenberg *et al.* (1985) showed that the amount of formaldehyde inhaled by rats per unit time is twice that inhaled by mice when the dosage is normalized to the surface area of the nasal passages. Other potential factors that may account for the species differences in sites of neoplasms are rates of production and clearance of the carcinogenic metabolite of naphthalene by the nasal epithelia and lungs. Activation and deactivation of naphthalene as well as the accumulation of the carcinogenic metabolite could be greater in the nasal

epithelia of rats than in mice; conversely, activation and deactivation of naphthalene and accumulation of the carcinogenic metabolite could be greater in the lungs of mice than in rats.

A physiologically based toxicokinetic model was developed to characterize the disposition of inhaled naphthalene in rats and mice (Appendix D). This model was used to estimate the following parameters: a) the amount of naphthalene inhaled by rats and mice (NTP, 1992) at the exposure concentrations used in the 2-year studies of this chemical, b) the amount of the inhaled dose that was metabolized during the 6-hour (rat) or 6-hour (mouse) exposure and during the 18 hours following exposure, c) the steady-state concentrations of naphthalene in the lung and liver of rats and mice during exposure, and d) the rate of naphthalene metabolism in the lung and liver of rats and mice at these steady-state concentrations. Approximately 22% to 31% of inhaled naphthalene is metabolized by rats and 65% to 73% of inhaled naphthalene is metabolized by mice. These values for the percentage of the inhaled parent compound that is metabolized are greater than those reported for volatile chemicals (Richardson *et al.*, 1999) and probably reflect the low vapor pressure of naphthalene and its very high estimated blood-to-air partition coefficient. Thus, once naphthalene is absorbed into the general circulation, very little parent compound is eliminated by exhalation. Because essentially all of the naphthalene that is absorbed is metabolized, the values for total naphthalene metabolized (presented in mg/kg body weight in Tables D5 and D6) represent the internalized dose of naphthalene in rats and mice resulting from the 6-hour exposures. The species difference in the absorption of inhaled naphthalene probably reflects the greater metabolic capacity of mice compared to rats. Increased metabolism will tend to increase the gradient in concentration of naphthalene in the alveolar space compared to the lung blood and thus enhance further absorption of the compound. Total naphthalene metabolized (i.e., the internalized dose) was nearly equivalent for mice exposed to 10 ppm and rats exposed to 60 ppm. This difference is due to the higher ventilation rates and greater metabolism of naphthalene in mice compared to rats.

These data also show that the steady-state concentration of naphthalene in the lung of rats is not very different from that of mice exposed to equivalent concentrations.

For example, after 6 hours of exposure to 30 ppm, the concentration of parent compound was 1.8 $\mu\text{g/mL}$ in rats and 2.6 to 2.8 $\mu\text{g/mL}$ in mice. Rats exposed to 60 ppm naphthalene had higher concentrations of naphthalene in the lung (5.3 $\mu\text{g/mL}$) than did mice exposed to 30 ppm. Rates of metabolism and the cumulative metabolism of naphthalene in the lung were markedly greater in mice than in rats. Rates of naphthalene metabolism did not increase proportionally with increasing exposure concentration, indicating metabolic saturation in this organ. Metabolic saturation was more evident in the rat lung than in the mouse lung. Naphthalene metabolism was also greater in the mouse liver than in the rat liver; however, the species difference in liver metabolism was not as marked as that in the lung. Metabolic saturation was only apparent in the liver of rats exposed to 60 ppm. For both species, 65% to 75% of the metabolic clearance occurred during the 6-hour exposure periods; only in 60 ppm rats was metabolic clearance at about 50% of the total inhaled dose. This is probably due to metabolic saturation resulting in greater storage of parent compound in the fat at this exposure concentration.

The results from the toxicokinetic model of naphthalene indicate that tissue dosimetry of parent compound does not alone explain why this chemical was carcinogenic to the mouse lung but not to the rat lung. For example, female rats exposed to 60 ppm naphthalene had a higher steady-state concentration of naphthalene in the lung than did female mice exposed to 30 ppm. The higher rates of naphthalene metabolism in the mouse lung compared to the rat lung may have been a contributing factor to this species difference in response. However, because the model does not include information on rates of detoxification of potential carcinogenic intermediates of naphthalene metabolism, it is not possible to compare lung concentrations of naphthalene metabolites to the exposure concentrations administered to rats and mice. If detoxification processes are faster in mice than in rats, then rates of metabolic activation alone could not serve as a reliable predictor of lung cancer risk. Naphthalene oxide is the primary metabolite formed by cytochrome P450-mediated oxidation of naphthalene. Mice appear to be more susceptible to lung neoplasm induction by epoxide and epoxide-forming chemicals than are rats (Melnick and Huff, 1993). Most notable in this respect is the finding that inhalation exposure to ethylene oxide induced lung neoplasms in mice (NTP,

1987) but not in rats (Lynch *et al.*, 1984; Snellings *et al.*, 1984). Thus, if naphthalene oxide is the sole agent responsible for lung neoplasm induction in mice exposed to naphthalene, then the species difference in response at this site may be due to a combination of higher rates of naphthalene oxide production in the mouse lung and, possibly, a greater susceptibility of the mouse lung to epoxide-induced carcinogenesis.

The mutagenic activity of naphthalene, as determined from the literature and from the results of NTP studies, is demonstrated primarily in assays that measure induction of chromosomal effects rather than gene mutations. The chemical did not induce mutations in *Salmonella* or cultured human MCL-5 cells, and the positive results in micronucleus assays (Djomo *et al.*, 1995; Sasaki *et al.*, 1997), chromosomal aberration tests (Appendix C), and recombination tests (Delgado-Rodriguez *et al.*, 1995) are consistent with a clastogenic mechanism of action. The results of the *Drosophila melanogaster* wing spot test (Delgado-Rodriguez *et al.*, 1995) and the NTP *in vitro* chromosomal aberrations test indicate that, at least for some endpoints, naphthalene mutagenicity requires or is enhanced by cytochrome P450 enzymes. The relation-

ship between the *in vitro* mutagenicity test results with naphthalene in certain short-term assays and the carcinogenic response that occurred in the current rat study is unclear, however, because the metabolic activation enzymes in the mutagenicity test systems would not be expected to include the CYP2F2 enzyme that is selectively expressed in lung and olfactory mucosal cells (Wang *et al.*, 1998) and that has been demonstrated recently to play a key role in the bioactivation of naphthalene in the nose (Wang *et al.*, 1998; Shultz *et al.*, 1999). Biotransformation of naphthalene to yield reactive intermediates is likely to be accomplished through additional pathways.

CONCLUSIONS

Under the conditions of this 2-year inhalation study, there was *clear evidence of carcinogenic activity** of naphthalene in male and female F344/N rats based on increased incidences of respiratory epithelial adenoma and olfactory epithelial neuroblastoma of the nose.

In male and female rats, exposure to naphthalene caused significant increases in the incidences of non-neoplastic lesions of the nose.

* Explanation of Levels of Evidence of Carcinogenic Activity is on page 8. A summary of the Technical Reports Review Subcommittee comments and the public discussion on this Technical Report appears on page 10.

REFERENCES

- Abdo, K.M., Eustis, S.L., McDonald, M., Jokinen, M.P., Adkins, B., Jr., and Haseman, J.K. (1992). Naphthalene: A respiratory tract toxicant and carcinogen for mice. *Inhalat. Toxicol.* **4**, 393-409.
- Adkins, B., Jr., Van Stee, E.W., Simmons, J.E., and Eustis, S.L. (1986). Oncogenic response of strain A/J mice to inhaled chemicals. *J. Toxicol. Environ. Health* **17**, 311-322.
- The Aldrich Library of FT-IR Spectra* (1985). 1st ed. (C.J. Pouchert, Ed.), Vol. 1, p. 956A. Aldrich Chemical Company, Inc., St. Louis, MO.
- Alexandrov, K., and Frayssinet, C. (1973). Brief communication: In vivo effect of some naphthalene-related compounds on aryl hydrocarbon (benzo[*a*]pyrene) hydroxylase. *J. Natl. Cancer Inst.* **51**, 1067-1069.
- American Conference of Governmental Industrial Hygienists (ACGIH) (1999). *1999 Threshold Limit Values for Chemical Substances and Physical Agents and Biological Exposure Indices*. Cincinnati, OH.
- Anziulewicz, J.A., Dick, H.J., and Chiarulli, E.E. (1959). Transplacental naphthalene poisoning. *Am. J. Obstet. Gynecol.* **78**, 519-521.
- Ashby, J., and Tennant, R.W. (1991). Definitive relationships among chemical structure, carcinogenicity and mutagenicity for 301 chemicals tested by the U.S. NTP. *Mutat. Res.* **257**, 229-306.
- Bagchi, D., Bagchi, M., Balmoori, J., Vuchetich, P.J., and Stohs, S.J. (1998). Induction of oxidative stress and DNA damage by chronic administration of naphthalene to rats. *Res. Commun. Mol. Pathol. Pharmacol.* **101**, 249-257.
- Bailer, A.J., and Portier, C.J. (1988). Effects of treatment-induced mortality and tumor-induced mortality on tests for carcinogenicity in small samples. *Biometrics* **44**, 417-431.
- Beratergremium für Umweltrelevante Altstoffe (BUA) (1989). Naphthalene (GDCh-Advisory Committee on Existing Chemicals of Environmental Relevance, Eds.). BUA Report 39. VCH Verlagsges., Weinheim, Germany.
- Bieler, G.S., and Williams, R.L. (1993). Ratio of estimates, the delta method, and quantal response tests for increased carcinogenicity. *Biometrics* **49**, 793-801.
- Bock, K.W., van Ackeren, G., Lorch, F., and Birke, F.W. (1976). Metabolism of naphthalene to naphthalene dihydrodiol glucuronide in isolated hepatocytes and in liver microsomes. *Biochem. Pharmacol.* **25**, 2351-2356.
- Bock, K.W., von Clausbruch, U.C., and Winne, D. (1979). Absorption and metabolism of naphthalene and benzo(*a*)pyrene in the rat jejunum *in situ*. *Med. Biol.* **57**, 262-264.
- Bolonova, L.N. (1967). Effect of naphthalene and its methyl derivatives on the content of ammonia in the brain of rats. *Farmakol. Toksikol.* **30**, 484-486.
- Boorman, G.A., Montgomery, C.A., Jr., Eustis, S.L., Wolfe, M.J., McConnell, E.E., and Hardisty, J.F. (1985). Quality assurance in pathology for rodent carcinogenicity studies. In *Handbook of Carcinogen Testing* (H.A. Milman and E.K. Weisburger, Eds.), pp. 345-357. Noyes Publications, Park Ridge, NJ.
- Bos, R.P., Theuws, J.L.G., Jongeneelen, F.J., and Henderson, P.T. (1988). Mutagenicity of bi-, tri- and tetra-cyclic aromatic hydrocarbons in the "taped-plate assay" and in the conventional Salmonella mutagenicity assay. *Mutat. Res.* **204**, 203-206.
- Boyland, E., Busby, E.R., Dukes, C.E., Grover, P.L., and Manson, D. (1964). Further experiments on implantation of materials into the urinary bladder of mice. *Br. J. Cancer* **18**, 575-581.

- Buckpitt, A.R., and Bahnson, L.S. (1986). Naphthalene metabolism by human lung microsomal enzymes. *Toxicology* **41**, 333-341.
- Buckpitt, A.R., and Richieri, P. (1984). Comparative biochemistry and metabolism: Part 2. Naphthalene lung toxicity. AFAMRL-TR-84-058. Systems Command, Aerospace Medical Division, Air Force Aerospace Medical Research Laboratory, Wright-Patterson Air Force Base, OH.
- Buckpitt, A.R., and Warren, D.L. (1983). Evidence for hepatic formation, export and covalent binding of reactive naphthalene metabolites in extrahepatic tissues *in vivo*. *J. Pharmacol. Exp. Ther.* **225**, 8-16.
- Buckpitt, A.R., Castagnoli, N., Jr., Nelson, S.D., Jones, A.D., and Bahnson, L.S. (1987). Stereoselectivity of naphthalene epoxidation by mouse, rat, and hamster pulmonary, hepatic, and renal microsomal enzymes. *Drug Metab. Dispos.* **15**, 491-498.
- Buckpitt, A., Buonarati, M., Avey, L.B., Chang, A.M., Morin, D., and Plopper, C.G. (1992). Relationship of cytochrome P450 activity and Clara cell cytotoxicity. II. Comparison of stereoselectivity of naphthalene epoxidation in lung and nasal mucosa of mouse, hamster, rat and rhesus monkey. *J. Pharmacol. Exp. Ther.* **261**, 364-372.
- Buckpitt, A., Chang, A.M., Weir, A., Van Winkle, L., Duan, X., Philpot, R., and Plopper, C. (1995). Relationship of cytochrome P450 activity to Clara cell cytotoxicity. IV. Metabolism of naphthalene and naphthalene oxide in microdissected airways from mice, rats, and hamsters. *Mol. Pharmacol.* **47**, 74-81.
- Buonarati, M., Jones, A.D., and Buckpitt, A. (1990). *In vivo* metabolism of isomeric naphthalene oxide glutathione conjugates. *Drug. Metab. Dispos.* **18**, 183-189.
- Chang, A., Plopper, C., Weir, A., Sassme, H., and Buckpitt, A. (1991). Correlation of species selective pulmonary toxicity to naphthalene (NA) with immunohistochemical localization of cytochrome P450MN and the stereoselective epoxidation of NA in airway explant incubations. *Toxicologist* **11**, 59 (Abstr.).
- Chang, L.H. (1943). Fecal excretion of polycyclic hydrocarbons following their administration to the rat. *J. Biol. Chem.* **151**, 93-99.
- Chemical Economics Handbook* [database online] (2000). SRI International, Menlo Park, CA.
- Chen, K.C., and Dorough, H.W. (1979). Glutathione and mercapturic acid conjugations in the metabolism of naphthalene and 1-naphthyl N-methylcarbamate (carbaryl). *Drug Chem. Toxicol.* **2**, 331-354.
- Code of Federal Regulations (CFR) **21**, Part 58.
- Connor, T.H., Theiss, J.C., Hanna, H.A., Monteith, D.K., and Matney, T.S. (1985). Genotoxicity of organic chemicals frequently found in the air of mobile homes. *Toxicol. Lett.* **25**, 33-40.
- Corner, E.D.S., and Young, L. (1954). The metabolism of naphthalene in animals of different species. *Biochem. J.* **58**, 647-655.
- Cox, D.R. (1972). Regression models and life-tables. *J. R. Stat. Soc.* **B34**, 187-220.
- Crawford, B.D. (1985). Perspectives on the somatic mutation model of carcinogenesis. In *Advances in Modern Environmental Toxicology. Mechanisms and Toxicity of Chemical Carcinogens and Mutagens* (M.A. Mehlman, W.G. Flamm, and R.J. Lorentzen, Eds.), pp. 13-59. Princeton Scientific Publishing Co., Inc., Princeton, NJ.
- Dawson, J.P., Thayer, W.W., and Desforges, J.F. (1958). Acute hemolytic anemia in the newborn infant due to naphthalene poisoning: Report of two cases, with investigations into the mechanism of the disease. *Blood* **13**, 1113-1125.
- de Bruin, A. (1976). *Biochemical Toxicology of Environmental Agents*, p. 1544. Elsevier/North-Holland Biomedical Press, New York.
- Delgado-Rodriguez, A., Ortíz-Marttelo, R., Graf, U., Villalobos-Pietrini, R., and Gómez-Arroyo, S. (1995). Genotoxic activity of environmentally important polycyclic aromatic hydrocarbons and their nitro derivatives in the wing spot test of *Drosophila melanogaster*. *Mutat. Res.* **341**, 235-247.

- Dixon, W.J., and Massey, F.J., Jr. (1951). *Introduction to Statistical Analysis*, 1st ed., pp. 145-147. McGraw-Hill Book Company, Inc., New York.
- Djomo, J.E., Ferrier, V., Gauthier, L., Zoll-Moreux, C., and Marty, J. (1995). Amphibian micronucleus test *in vivo*: Evaluation of the genotoxicity of some major polycyclic aromatic hydrocarbons found in a crude oil. *Mutagenesis* **10**, 223-226.
- Doherty, M.A., Makowski, R., Gibson, G.G., and Cohen, G.M. (1985). Cytochrome P-450 dependent metabolic activation of 1-naphthol to naphthoquinones and covalent binding species. *Biochem. Pharmacol.* **34**, 2261-2267.
- Dunnett, C.W. (1955). A multiple comparison procedure for comparing several treatments with a control. *J. Am. Stat. Assoc.* **50**, 1096-1121.
- Eisele, G.R. (1985). Naphthalene distribution in tissues of laying pullets, swine, and dairy cattle. *Bull. Environ. Contam. Toxicol.* **34**, 549-556.
- Fanucchi, M.V., Buckpitt, A.R., Murphy, M.E., and Plopper, C.G. (1997). Naphthalene cytotoxicity of differentiating Clara cells in neonatal mice. *Toxicol. Appl. Pharmacol.* **144**, 96-104.
- Florin, I., Rutberg, L., Curvall, M., and Enzell, C.R. (1980). Screening of tobacco smoke constituents for mutagenicity using the Ames' test. *Toxicology* **15**, 219-232.
- Galloway, S.M., Armstrong, M.J., Reuben, C., Colman, S., Brown, B., Cannon, C., Bloom, A.D., Nakamura, F., Ahmed, M., Duk, S., Rimpo, J., Margolin, B.H., Resnick, M.A., Anderson, B., and Zeiger, E. (1987). Chromosome aberrations and sister chromatid exchanges in Chinese hamster ovary cells: Evaluations of 108 chemicals. *Environ. Mol. Mutagen.* **10** (Suppl. 10), 1-175.
- Gerarde, H.W. (1960). *Toxicology and Biochemistry of Aromatic Hydrocarbons*, pp. 225-232. Elsevier, Amsterdam.
- Ghetti, G., and Mariani, L. (1956). Eye changes due to naphthalene. *Med. Lav.* **47**, 524.
- Gidron, E., and Leurer, J. (1956). Naphthalene poisoning. *Lancet* **1**, 228-230.
- Gosselin, R.E., Smith, R.P., and Hodge, H.C. (1984). *Clinical Toxicology of Commercial Products*, 5th ed., p. III-307. Williams and Wilkins, Baltimore.
- Haddad, L.M., and Winchester, J.F. (1983). *Clinical Management of Poisoning and Drug Overdose*, p. 888. Saunders, Philadelphia.
- Hansch, C., Leo, A., and Hoekman, D. (1995). *QSAR-Hydrophobic, Electronic, and Steric Constants*. American Chemical Society, Washington, DC.
- Harden, R.A., and Baetjer, A.M. (1978). Aplastic anemia following exposure to paradichlorobenzene and naphthalene. *J. Occup. Med.* **20**, 820-822.
- Harkema, J.R., and Morgan, K.T. (1996). Proliferative and metaplastic lesions in nonolfactory nasal epithelia induced by inhaled chemicals. In *Respiratory System* (T.C. Jones, D.L. Dungrowth, and U. Mohr, Eds.) 2nd ed., pp. 18-28. Springer-Verlag, Berlin.
- Hollander, M., and Wolfe, D.A. (1973). *Nonparametric Statistical Methods*, pp. 120-123. John Wiley and Sons, New York.
- Honda, T., Kiyozumi, M., and Kojima, S. (1990). Alkyl-naphthalene. XI. Pulmonary toxicity of naphthalene, 2-methylnaphthalene, and isopropyl-naphthalenes in mice. *Chem. Pharm. Bull. (Tokyo)* **38**, 3130-3135.
- Horning, M.G., Stillwell, W.G., Griffin, G.W., and Tsang, W.S. (1980). Epoxide intermediates in the metabolism of naphthalene by the rat. *Drug Metab. Dispos.* **8**, 404-414.
- Jerina, D.M., Daly, J.W., Witkop, B., Zaltzman-Nirenberg, P., and Udenfriend, S. (1970). 1,2-Naphthalene oxide as an intermediate in the microsomal hydroxylation of naphthalene. *Biochemistry* **9**, 147-156.
- Jonckheere, A.R. (1954). A distribution-free *k*-sample test against ordered alternatives. *Biometrika* **41**, 133-145.

- Kaplan, E.L., and Meier, P. (1958). Nonparametric estimation from incomplete observations. *J. Am. Stat. Assoc.* **53**, 457-481.
- Kawachi, T., Yahagi, T., Kada, T., Tazima, Y., Ishidate, M., Sasaki, M., and Sugiyama, T. (1980). Cooperative programme on short-term assays for carcinogenicity in Japan. *IARC Sci. Publ.* **27**, 323-330.
- Kennaway, E.L. (1930). Further experiments on cancer-producing substances. *Biochem. J.* **24**, 497-504.
- Kirk-Othmer Encyclopedia of Chemical Technology* (1978). 3rd ed. (M. Grayson, Ed.), Vol. 2, p. 704. John Wiley and Sons, New York.
- Kirk-Othmer Encyclopedia of Chemical Technology* (1979). 3rd ed. (M. Grayson and D. Eckroth, Eds.), Vol. 8, p. 367. John Wiley and Sons, New York.
- Kirk-Othmer Encyclopedia of Chemical Technology* (1981). 3rd ed. (M. Grayson and D. Eckroth, Eds.), Vol. 13, p. 466, and Vol. 15, p. 460. John Wiley and Sons, New York.
- Knake, E. (1956). Über schwache geschwulsterzeugende Wirkung von Naphthalin und Benzol. *Virchows Arch. Pathol. Anat. Physiol.* **329**, 141-176.
- Koch, H.R., and Doldi, K. (1975). Naphthalene cataracts in rats of differently pigmented strains. *Exp. Eye Res.* **20**, 180 (Abstr.).
- Konar, N.R., Roy, H.K., and De, M.N. (1939). Naphthalene poisoning. *Indian Med. Gaz.* **74**, 723-725.
- Kup, W. (1978). Work-related origin of cancer in the nose, mouth, throat, larynx. *Akad. Wiss.* **2**, 20-25.
- Lakritz, J., Chang, A., Weir, A., Nishio, S., Hyde, D., Philpot, R., Buckpitt, A., and Plopper, C. (1996). Cellular and metabolic basis of Clara cell tolerance to multiple doses of cytochrome P450-activated cytotoxicants. I: Bronchiolar epithelial reorganization and expression of cytochrome P450 monooxygenases in mice exposed to multiple doses of naphthalene. *J. Pharmacol. Exp. Ther.* **278**, 1408-1418.
- Lezenius, A. (1902). Ein Fall von Naphthalincataract am Menschen. *Klin. Monatsbl. Augenheilkd.* **40**, 129-140.
- Lide, D.R., Ed. (1992). *CRC Handbook of Chemistry and Physics*, 73rd ed., p. 3-327. CRC Press, Boca Raton, FL.
- Lynch, D.W., Lewis, T.R., Moorman, W.J., Burg, J.R., Groth, D.H., Khan, A., Ackerman, L.J., and Cockrell, B.Y. (1984). Carcinogenic and toxicologic effects of inhaled ethylene oxide and propylene oxide in F344 rats. *Toxicol. Appl. Pharmacol.* **76**, 69-84.
- McConnell, E.E., Solleveld, H.A., Swenberg, J.A., and Boorman, G.A. (1986). Guidelines for combining neoplasms for evaluation of rodent carcinogenesis studies. *JNCI* **76**, 283-289.
- McElroy, E.A., Jr., Buckner, J.C., and Lewis, J.E. (1998). Chemotherapy for advanced esthesioneuroblastoma: The Mayo Clinic experience. *Neurosurgery* **42**, 1023-1028.
- MacGregor, R.R. (1954). Naphthalene poisoning from the ingestion of moth balls. *Can. Med. Assoc. J.* **70**, 313-314.
- Mahvi, D., Bank, H., and Harley, R. (1977). Morphology of a naphthalene-induced bronchiolar lesion. *Am. J. Pathol.* **86**, 558-572.
- Maronpot, R.R., and Boorman, G.A. (1982). Interpretation of rodent hepatocellular proliferative alterations and hepatocellular tumors in chemical safety assessment. *Toxicol. Pathol.* **10**, 71-80.
- Melnick, R.L., and Huff, J.E. (1993). 1,3-Butadiene induces cancer in experimental animals at all concentrations from 6.25 to 8000 parts per million. *IARC Sci. Publ.* **127**, 309-322.
- Melzer-Lange, M., and Walsh-Kelly, C. (1989). Naphthalene-induced hemolysis in a black female toddler deficient in glucose-6-phosphate dehydrogenase. *Pediatr. Emerg. Care* **5**, 24-26.
- The Merck Index* (1989). 11th ed. (S. Budavari, Ed.), p. 1008. Merck and Company, Inc., Rahway, NJ.

The Merck Index (1996). 12th ed. (S. Budavari, Ed.), p. 1094. Merck and Company, Inc., Whitehouse Station, NJ.

Mersch-Sundermann, V., Mochayedi, S., and Kevekordes, S. (1992). Genotoxicity of polycyclic aromatic hydrocarbons in *Escherichia coli* PQ37. *Mutat. Res.* **278**, 1-9.

Miller, J.A., and Miller, E.C. (1977). Ultimate chemical carcinogens as reactive mutagenic electrophiles. In *Origins of Human Cancer* (H.H. Hiatt, J.D. Watson, and J.A. Winsten, Eds.), pp. 605-627. Cold Spring Harbor Laboratory, Cold Spring Harbor, NY.

Miller, R.R., Young, J.T., Kociba, R.J., Keyes, D.G., Bonder, K.M., Calhoun, L.L., and Ayres, J.A. (1985). Chronic toxicity and oncogenicity bioassay of inhaled ethyl acrylate in Fischer 344 rats and B6C3F1 mice. *Drug Chem. Toxicol.* **8**, 1-42.

Mortelmans, K., Haworth, S., Lawlor, T., Speck, W., Tainer, B., and Zeiger, E. (1986). *Salmonella* mutagenicity tests: II. Results from the testing of 270 chemicals. *Environ. Mutagen.* **8** (Suppl. 7), 1-119.

Narbonne, J.F., Cassand, P., Alzieu, P., Grolier, P., Mrlina, G., and Calmon, J.P. (1987). Structure-activity relationships of the *N*-methylcarbamate series in *Salmonella typhimurium*. *Mutat. Res.* **191**, 21-27.

National Institute for Occupational Safety and Health (NIOSH) (1997). *NIOSH Pocket Guide to Chemical Hazards*. U.S. Department of Health and Human Services, Public Health Service, Centers for Disease Control, Washington, DC.

National Toxicology Program (NTP) (1987). Toxicology and Carcinogenesis Studies of Ethylene Oxide (CAS No. 75-21-8) in B6C3F₁ Mice (Inhalation Studies). Technical Report Series No. 326. NIH Publication No. 88-2582. U.S. Department of Health and Human Services, Public Health Service, National Institutes of Health, Research Triangle Park, NC.

National Toxicology Program (NTP) (1992). Toxicology and Carcinogenesis Studies of Naphthalene (CAS No. 91-20-3) in B6C3F₁ Mice (Inhalation Studies). Technical Report Series No. 410. NIH Publication No. 92-3141. U.S. Department of Health and Human Services, Public Health Service, National Institutes of Health, Research Triangle Park, NC.

National Toxicology Program (NTP) (1997). Toxicology and Carcinogenesis Studies of Nitromethane (CAS No. 75-52-5) in F344/N Rats and B6C3F₁ Mice (Inhalation Studies). Technical Report Series No. 461. NIH Publication No. 97-3377. U.S. Department of Health and Human Services, Public Health Service, National Institutes of Health, Research Triangle Park, NC.

National Toxicology Program (NTP) (1998a). Toxicology and Carcinogenesis Studies of Chloroprene (CAS No. 126-99-8) in F344/N Rats and B6C3F₁ Mice (Inhalation Studies). Technical Report Series No. 467. NIH Publication No. 98-3957. U.S. Department of Health and Human Services, Public Health Service, National Institutes of Health, Research Triangle Park, NC.

National Toxicology Program (NTP) (1998b). Toxicology and Carcinogenesis Studies of Cobalt Sulfate Heptahydrate (CAS No. 10026-24-1) in F344/N Rats and B6C3F₁ Mice (Inhalation Studies). Technical Report Series No. 471. NIH Publication No. 98-3961. U.S. Department of Health and Human Services, Public Health Service, National Institutes of Health, Research Triangle Park, NC.

National Toxicology Program (NTP) (1999). Toxicology and Carcinogenesis Studies of Glutaraldehyde (CAS No. 111-30-8) in F344/N Rats and B6C3F₁ Mice (Inhalation Studies). Technical Report Series No. 490. NIH Publication No. 99-3980. U.S. Department of Health and Human Services, Public Health Service, National Institutes of Health, Research Triangle Park, NC.

- Nohmi, T., Miyata, R., Yoshikawa, K., and Ishidate, M., Jr. (1985). Mutagenicity tests on organic chemical contaminants in city water and related compounds. I. Bacterial mutagenicity tests [in Japanese, English summary]. *Bull. Natl. Inst. Hyg. Sci.* **103**, 60-64.
- O'Brien, K.A.F., Smith, L.L., and Cohen, G.M. (1985). Differences in naphthalene-induced toxicity in the mouse and rat. *Chem. Biol. Interact.* **55**, 109-122.
- Piegorsch, W.W., and Bailer, A.J. (1997). *Statistics for Environmental Biology and Toxicology*, Section 6.3.2. Chapman and Hall, London.
- Pino, M.V., Valerio, M.G., Miller, G.K., Larson, J.L., Rosolia, D.L., Jayyosi, Z., Crouch, C.N., Trojanowski, J.Q., and Geiger, L.E. (1999). Toxicologic and carcinogenic effects of the Type IV phosphodiesterase inhibitor RP 73401 on the nasal olfactory tissue in rats. *Toxicol. Pathol.* **27**, 383-394.
- Plopper, C.G., Suverkropp, C., Morin, D., Nishio, S., and Buckpitt, A. (1992). Relationship of cytochrome P-450 activity to Clara cell cytotoxicity. I. Histopathologic comparison of the respiratory tract of mice, rats and hamsters after parenteral administration of naphthalene. *J. Pharmacol. Exp. Ther.* **261**, 353-363.
- Portier, C.J., and Bailer, A.J. (1989). Testing for increased carcinogenicity using a survival-adjusted quantal response test. *Fundam. Appl. Toxicol.* **12**, 731-737.
- Portier, C.J., Hedges, J.C., and Hoel, D.G. (1986). Age-specific models of mortality and tumor onset for historical control animals in the National Toxicology Program's carcinogenicity experiments. *Cancer Res.* **46**, 4372-4378.
- Potts, A.M. (1996). Toxic responses of the eye. In *Casarett and Doull's Toxicology: The Basic Science of Poisons* (C.D. Klaassen, Ed.), 5th ed., pp. 583-616. McGraw-Hill, New York.
- Probst, G.S., McMahon, R.E., Hill, L.E., Thompson, C.Z., Epp, J.K., and Neal, S.B. (1981). Chemically-induced unscheduled DNA synthesis in primary rat hepatocyte cultures: A comparison with bacterial mutagenicity using 218 compounds. *Environ. Mutagen.* **3**, 11-32.
- Rao, G.N. (1996). New diet (NTP-2000) for rats in the National Toxicology Program toxicity and carcinogenicity studies. *Fundam. Appl. Toxicol.* **32**, 102-108.
- Rao, G.N. (1997). New nonpurified diet (NTP-2000) for rodents in the National Toxicology Program's toxicology and carcinogenesis studies. *J. Nutr.* **127**, 842S-846S.
- Rathbun, W.B., Holleschau, A.M., Murray, D.L., Buchanan, A., Sawaguchi, S., and Tao, R.V. (1990). Glutathione synthesis and glutathione redox pathways in naphthalene cataract of the rat. *Curr. Eye Res.* **9**, 45-53.
- Rathbun, W.B., Nagasawa, H.T., and Killen, C.E. (1996a). Prevention of naphthalene-induced cataract and hepatic glutathione loss by the L-cysteine prodrugs, MTCA and PTCA. *Exp. Eye Res.* **62**, 433-441.
- Rathbun, W.B., Holleschau, A.M., Cohen, J.F., and Nagasawa, H.T. (1996b). Prevention of acetaminophen- and naphthalene-induced cataract and glutathione loss by CySSME. *Invest. Ophthalmol. Vis. Sci.* **37**, 923-929.
- Richardson, K.A., Peters, M.M., Wong, B.A., Megens, R.H., van Elburg, P.A., Booth, E.D., Boogaard, P.J., Bond, J.A., Medinsky, M.A., Watson, W.P., and van Sittert, N.J. (1999). Quantitative and qualitative differences in the metabolism of ¹⁴C-1,3-butadiene in rats and mice: Relevance to cancer susceptibility. *Toxicol. Sci.* **49**, 186-201.
- Rossoff, I.S. (1974). *Handbook of Veterinary Drugs*, p. 377. Springer Publishing, New York.
- Sadtler Standard Spectra*. IR No. 169K; NMR No. 62M. Sadtler Research Laboratories, Philadelphia.

- Sakai, M., Yoshida, D., and Mizusaki, S. (1985). Mutagenicity of polycyclic aromatic hydrocarbons and quinones on *Salmonella typhimurium* TA97. *Mutat. Res.* **156**, 61-67.
- Santhanakrishnan, B.R., Ranganathan, G., and Raju, V.B. (1973). Naphthalene induced haemolytic anaemia with haemoglobinuria. *Indian J. Pediatr.* **40**, 195-197.
- Sasaki, J.C., Arey, J., Eastmond, D.A., Parks, K.K., and Grosovsky, A.J. (1997). Genotoxicity induced in human lymphoblasts by atmospheric reaction products of naphthalene and phenanthrene. *Mutat. Res.* **393**, 23-35.
- Sax, N.I. (1984). *Dangerous Properties of Industrial Materials*, 6th ed., p. 1971. Van Nostrand Reinhold Company, New York.
- Schmahl, D. (1955). Prüfung von Naphthalin und Anthracen auf cancerogene Wirkung an Ratten. *Zeit. Krebsforsch.* **60**, 697-710.
- Schmeltz, I., Tosk, J., Hilfrich, J., Horita, N., Hoffman, D., and Wynder, E.L. (1978). Bioassays of naphthalene and alkylnaphthalenes for co-carcinogenic activity: Relation to tobacco carcinogenesis. In *Carcinogenesis—A Comprehensive Survey* (P.W. Jones and R.I. Freudenthal, Eds.), Vol. 3, pp. 47-60. Raven, New York.
- Shichi, H., Tanaka, M., Jensen, N.M., and Nebert, D.W. (1980). Genetic differences in cataract and other ocular abnormalities induced by paracetamol and naphthalene. *Pharmacology* **20**, 229-241.
- Shopp, G.M., White, K.L., Jr., Holsapple, M.P., Barnes, D.W., Duke, S.S., Anderson, A.C., Condie, L.W., Jr., Hayes, J.R., and Borzelleca, J.F. (1984). Naphthalene toxicity in CD-1 mice: General toxicology and immunotoxicology. *Fundam. Appl. Toxicol.* **4**, 406-419.
- Shultz, M.A., Choudary, P.V., and Buckpitt, A.R. (1999). Role of murine cytochrome P-450 2F2 in metabolic activation of naphthalene and metabolism of other xenobiotics. *J. Pharmacol. Exp. Ther.* **290**, 281-288.
- Sims, P., and Grover, P.L. (1974). Epoxides in polycyclic aromatic hydrocarbon metabolism and carcinogenesis. *Adv. Cancer Res.* **20**, 165-274.
- Snellings, W.M., Weil, C.S., and Maronpot, R.R. (1984). A two-year inhalation study of the carcinogenic potential of ethylene oxide in Fischer 344 rats. *Toxicol. Appl. Pharmacol.* **75**, 105-117.
- Straus, D.S. (1981). Somatic mutation, cellular differentiation, and cancer causation. *JNCI* **67**, 233-241.
- Summer, K.H., Rozman, K., Coulston, F., and Greim, H. (1979). Urinary excretion of mercapturic acids in chimpanzees and rats. *Toxicol. Appl. Pharmacol.* **50**, 207-212.
- Suter, W., and Jaeger, I. (1982). Comparative evaluation of different pairs of DNA repair-deficient and DNA repair-proficient bacterial tester strains for rapid detection of chemical mutagens and carcinogens. *Mutat. Res.* **97**, 1-18.
- Swenberg, J.A., Heck, Hd'A, Morgan, K.T., and Star, T.B. (1985). A scientific approach to formaldehyde risk assessment. In *Risk Quantitation and Regulatory Policy: 19th Banbury Report* (D.G. Hoel, R.A. Merrill, and F.P. Perera, Eds.), pp. 255-267. Cold Spring Harbor, NY.
- Takizawa, N. (1940). Carcinogenic action of quinones. *Proc. Imp. Acad. (Tokyo)* **16**, 309.
- Tanooka, H. (1977). Development and applications of *Bacillus subtilis* test systems for mutagens involving DNA-repair deficiency and suppressible auxotrophic mutations. *Mutat. Res.* **42**, 19-31.
- Tao, R.V., Holleschau, A.M., and Rathbun, W.B. (1991). Naphthalene-induced cataract in the rat. II. Contrasting effects of two aldose reductase inhibitors on glutathione and glutathione redox enzymes. *Ophthalmic Res.* **23**, 272-283.
- Tarone, R.E. (1975). Tests for trend in life table analysis. *Biometrika* **62**, 679-682.
- Taylor, C.J.S.O., and Russell, H. (1932). Blackwater fever and naphthalene poisoning. *West Afr. Med. J.* **5**, 48-49.

- Tennant, R.W., Margolin, B.H., Shelby, M.D., Zeiger, E., Haseman, J.K., Spalding, J., Caspary, W., Resnick, M., Stasiewicz, S., Anderson, B., and Minor, R. (1987). Prediction of chemical carcinogenicity in rodents from *in vitro* genetic toxicity assays. *Science* **236**, 933-941.
- Thornton-Manning, J.R., and Dahl, A.R. (1997). Metabolic capacity of nasal tissue interspecies comparisons of xenobiotic-metabolizing enzymes. *Mutat. Res.* **380**, 43-59.
- Tingle, M.D., Pirmohamed, M., Templeton, E., Wilson, A.S., Madden, S., Kitteringham, N.R., and Park, B.K. (1993). An investigation of the formation of cytotoxic, genotoxic, protein-reactive and stable metabolites from naphthalene by human liver microsomes. *Biochem. Pharmacol.* **46**, 1529-1538.
- Tong, S.S., Hirokata, Y., Trush, M.A., Mimnaugh, E.G., Ginsburg, E., Lowe, M.C., and Gram, T.E. (1981). Clara cell damage and inhibition of pulmonary mixed-function oxidase activity by naphthalene. *Biochem. Biophys. Res. Commun.* **100**, 944-950.
- Tong, S.S., Lowe, M.C., Trush, M.A., Mimnaugh, E.G., Ginsburg, E., Hirokata, Y., and Gram, T.E. (1982). Bronchiolar epithelial damage and impairment of pulmonary microsomal monooxygenase activity in mice by naphthalene. *Exp. Mol. Pathol.* **37**, 358-369.
- Turkall, R.M., Skowronski, G.A., Kadry, A.M., and Abdel-Rahman, M.S. (1994). A comparative study of the kinetics and bioavailability of pure and soil-adsorbed naphthalene in dermally exposed male rats. *Arch. Environ. Contam. Toxicol.* **26**, 504-509.
- U.S. Environmental Protection Agency (USEPA) (1980). Ambient Water Quality Criteria for Naphthalene. USEPA 440/5-80-059. NTIS PB81-117707. Office of Health and Environmental Assessment, Environmental Criteria and Assessment Office, Cincinnati, OH.
- U.S. Environmental Protection Agency (USEPA) (1990). Drinking Water Health Advisories for 15 Volatile Organic Chemicals. NTIS PB90-259821. Office of Drinking Water, Washington, DC.
- Valaes, T., Doxiadis, S.A., and Fessas, P. (1963). Acute hemolysis due to naphthalene inhalation. *J. Pediatr.* **63**, 904-915.
- Van der Hoeve, J. (1906). Choreoretinitis beim Menschen durch die Einwirkung von Naphthalin. *Arch. Augenheilk.* **56**, 259.
- van Heyningen, R. (1979). Naphthalene cataract in rats and rabbits: A resume. *Exp. Eye Res.* **28**, 435-439.
- Vuchetich, P.J., Bagchi, D., Bagchi, M., Hassoun, E.A., Tang, L., and Stohs, S.J. (1996). Naphthalene-induced oxidative stress in rats and the protective effects of vitamin E succinate. *Free Radic. Biol. Med.* **21**, 577-590.
- Wang, H., Lanza, D.L., and Yost, G.S. (1998). Cloning and expression of CYP2F3, a cytochrome P450 that bioactivates the selective pneumotoxins 3-methylindole and naphthalene. *Arch. Biochem. Biophys.* **349**, 329-340.
- Wells, P.G., Wilson, B., and Lubek, B.M. (1989). *In vivo* murine studies on the biochemical mechanism of naphthalene cataractogenesis. *Toxicol. Appl. Pharmacol.* **99**, 466-473.
- Wiley Mass Spectral Database. Spectrum No. 6075. Hewlett-Packard, Palo Alto, CA.
- Williams, D.A. (1971). A test for differences between treatment means when several dose levels are compared with a zero dose control. *Biometrics* **27**, 103-117.
- Williams, D.A. (1972). The comparison of several dose levels with a zero dose control. *Biometrics* **28**, 519-531.
- Wilson, A.S., Tingle, M.D., Kelly, M.D., and Park, B.K. (1995). Evaluation of the generation of genotoxic and cytotoxic metabolites of benzo[a]pyrene, aflatoxin B₁, naphthalene and tamoxifen using human liver microsomes and human lymphocytes. *Hum. Exp. Toxicol.* **14**, 507-515.

- Wolf, O. (1976). Cancer among chemical workers of a naphthalene cleaning plant. *Dtsch. Gesundheitsw.* **31**, 996-999.
- Wolf, O. (1978). Carcinoma of the larynx in naphthalene cleaners. *Z. Gesamte Hyg.* **24**, 737-739.
- Zeiger, E., Haseman, J.K., Shelby, M.D., Margolin, B.H., and Tennant, R.W. (1990). Evaluation of four in vitro genetic toxicity tests for predicting rodent carcinogenicity: Confirmation of earlier results with 41 additional chemicals. *Environ. Mol. Mutagen.* **16** (Suppl. 18), 1-14.
- Zheng, J., Cho, M., Jones, A.D., and Hammock, B.D. (1997). Evidence of quinone metabolites of naphthalene covalently bound to sulfur nucleophiles of proteins of murine Clara cells after exposure to naphthalene. *Chem. Res. Toxicol.* **10**, 1008-1014.
- Zinkham, W.H., and Childs, B. (1958). A defect of glutathione metabolism in erythrocytes from patients with naphthalene-induced hemolytic anemia. *Pediatrics* **22**, 461-471.
- Zuelzer, W.W., and Apt, L. (1949). Acute hemolytic anemia due to naphthalene poisoning. *J. Am. Med. Assoc.* **141**, 185-190.

APPENDIX A
SUMMARY OF LESIONS IN MALE RATS
IN THE 2-YEAR INHALATION STUDY
OF NAPHTHALENE

TABLE A1	Summary of the Incidence of Neoplasms in Male Rats in the 2-Year Inhalation Study of Naphthalene	56
TABLE A2	Individual Animal Tumor Pathology of Male Rats in the 2-Year Inhalation Study of Naphthalene	60
TABLE A3	Statistical Analysis of Primary Neoplasms in Male Rats in the 2-Year Inhalation Study of Naphthalene	84
TABLE A4	Historical Incidence of Nasal Adenoma or Neuroblastoma in Control Male F344/N Rats	89
TABLE A5	Summary of the Incidence of Nonneoplastic Lesions in Male Rats in the 2-Year Inhalation Study of Naphthalene	90

TABLE A1
Summary of the Incidence of Neoplasms in Male Rats in the 2-Year Inhalation Study of Naphthalene^a

	Chamber Control	10 ppm	30 ppm	60 ppm
Disposition Summary				
Animals initially in study	49	49	49	49
Early deaths				
Moribund	21	22	19	25
Natural deaths	4	5	6	3
Survivors				
Terminal sacrifice	24	22	23	21
Missexed			1	
Animals examined microscopically	49	49	48	49
Alimentary System				
Intestine large, colon	(48)	(49)	(48)	(48)
Polyp adenomatous			1 (2%)	
Intestine large, cecum	(46)	(49)	(47)	(48)
Intestine small, jejunum	(45)	(47)	(43)	(47)
Carcinoma				1 (2%)
Leiomyosarcoma				1 (2%)
Intestine small, ileum	(45)	(47)	(45)	(47)
Liver	(49)	(49)	(48)	(49)
Hepatocellular carcinoma	1 (2%)			1 (2%)
Hepatocellular adenoma	1 (2%)			3 (6%)
Mesentery	(13)	(6)	(9)	(8)
Hemangiosarcoma				1 (13%)
Sarcoma	1 (8%)			
Pancreas	(49)	(49)	(48)	(49)
Adenoma	1 (2%)			2 (4%)
Carcinoma				1 (2%)
Mixed tumor benign			1 (2%)	
Salivary glands	(49)	(49)	(47)	(49)
Stomach, forestomach	(49)	(49)	(48)	(49)
Stomach, glandular	(49)	(49)	(48)	(49)
Tongue		(1)	(1)	
Squamous cell carcinoma		1 (100%)		
Cardiovascular System				
Heart	(49)	(49)	(48)	(49)
Schwannoma benign		1 (2%)	2 (4%)	
Schwannoma malignant, metastatic, skin			1 (2%)	

TABLE A1
Summary of the Incidence of Neoplasms in Male Rats in the 2-Year Inhalation Study of Naphthalene

	Chamber Control	10 ppm	30 ppm	60 ppm
Endocrine System				
Adrenal cortex	(49)	(49)	(48)	(49)
Adenoma	2 (4%)		1 (2%)	2 (4%)
Adrenal medulla	(49)	(49)	(47)	(49)
Pheochromocytoma malignant	1 (2%)	3 (6%)	1 (2%)	1 (2%)
Pheochromocytoma benign	4 (8%)	6 (12%)	6 (13%)	8 (16%)
Bilateral, pheochromocytoma benign		1 (2%)		
Islets, pancreatic	(49)	(49)	(48)	(49)
Adenoma	2 (4%)	5 (10%)	3 (6%)	2 (4%)
Carcinoma	4 (8%)	4 (8%)	4 (8%)	4 (8%)
Pituitary gland	(49)	(49)	(47)	(49)
Pars distalis, adenoma	31 (63%)	31 (63%)	35 (74%)	29 (59%)
Thyroid gland	(46)	(47)	(45)	(47)
Bilateral, C-cell, adenoma		1 (2%)		
C-cell, adenoma	9 (20%)	5 (11%)	4 (9%)	4 (9%)
C-cell, carcinoma	1 (2%)	2 (4%)	1 (2%)	1 (2%)
Follicular cell, adenoma			1 (2%)	
Follicular cell, carcinoma		1 (2%)		
General Body System				
Tissue NOS		(1)		
Pheochromocytoma malignant, metastatic, adrenal medulla		1 (100%)		
Genital System				
Epididymis	(49)	(49)	(48)	(49)
Preputial gland	(48)	(49)	(47)	(49)
Adenoma	3 (6%)		1 (2%)	1 (2%)
Carcinoma	3 (6%)	1 (2%)	1 (2%)	1 (2%)
Prostate	(49)	(49)	(48)	(49)
Seminal vesicle	(47)	(49)	(47)	(47)
Carcinoma			1 (2%)	
Testes	(49)	(49)	(48)	(49)
Bilateral, interstitial cell, adenoma	24 (49%)	22 (45%)	19 (40%)	20 (41%)
Interstitial cell, adenoma	14 (29%)	10 (20%)	17 (35%)	11 (22%)
Hematopoietic System				
Bone marrow	(49)	(49)	(48)	(49)
Lymph node	(3)	(3)	(8)	(4)
Lymph node, bronchial	(29)	(36)	(38)	(35)
Lymph node, mandibular	(40)	(45)	(46)	(44)
Lymph node, mesenteric	(47)	(49)	(48)	(49)
Lymph node, mediastinal	(24)	(28)	(44)	(41)
Spleen	(49)	(49)	(48)	(49)
Hemangiosarcoma		1 (2%)		1 (2%)
Thymus	(47)	(46)	(43)	(46)
Schwannoma malignant, metastatic, skin			1 (2%)	

TABLE A1
Summary of the Incidence of Neoplasms in Male Rats in the 2-Year Inhalation Study of Naphthalene

	Chamber Control	10 ppm	30 ppm	60 ppm
Integumentary System				
Mammary gland	(21)	(20)	(30)	(28)
Carcinoma	1 (5%)	1 (5%)	1 (3%)	
Fibroadenoma				3 (11%)
Skin	(48)	(48)	(48)	(48)
Basal cell adenoma		1 (2%)	2 (4%)	
Keratoacanthoma	4 (8%)	3 (6%)	2 (4%)	2 (4%)
Squamous cell carcinoma		1 (2%)		
Sebaceous gland, adenoma	1 (2%)	1 (2%)		1 (2%)
Sebaceous gland, carcinoma			1 (2%)	
Subcutaneous tissue, fibroma	5 (10%)	2 (4%)	2 (4%)	2 (4%)
Subcutaneous tissue, fibrosarcoma	2 (4%)	1 (2%)		2 (4%)
Subcutaneous tissue, fibrosarcoma, multiple		1 (2%)		
Subcutaneous tissue, lipoma	1 (2%)	1 (2%)	3 (6%)	
Subcutaneous tissue, neural crest tumor				1 (2%)
Subcutaneous tissue, sarcoma		1 (2%)	2 (4%)	
Subcutaneous tissue, schwannoma malignant			1 (2%)	
Musculoskeletal System				
Bone	(49)	(49)	(48)	(49)
Osteosarcoma	1 (2%)	1 (2%)		
Nervous System				
Brain	(49)	(49)	(48)	(49)
Neuroblastoma, metastatic, nose				2 (4%)
Spinal cord		(1)		
Respiratory System				
Larynx	(49)	(49)	(48)	(49)
Schwannoma malignant, metastatic, skin			1 (2%)	
Lung	(49)	(49)	(48)	(49)
Alveolar/bronchiolar adenoma	2 (4%)		1 (2%)	
Alveolar/bronchiolar carcinoma		3 (6%)		
Carcinoma, metastatic, preputial gland	1 (2%)			
Carcinoma, metastatic, thyroid gland	1 (2%)			
Carcinoma, metastatic, Zymbal's gland			1 (2%)	1 (2%)
Neuroblastoma, metastatic, nose			1 (2%)	1 (2%)
Osteosarcoma, metastatic, bone	1 (2%)	1 (2%)		
Pheochromocytoma malignant, metastatic, adrenal medulla	1 (2%)	1 (2%)	1 (2%)	
Schwannoma malignant, metastatic, skin			1 (2%)	
Nose	(49)	(49)	(48)	(48)
Olfactory epithelium, neuroblastoma			4 (8%)	3 (6%)
Respiratory epithelium, adenoma		6 (12%)	8 (17%)	15 (31%)
Special Senses System				
Eye	(48)	(48)	(48)	(48)
Zymbal's gland			(1)	(1)
Carcinoma			1 (100%)	
Bilateral, carcinoma				1 (100%)

TABLE A1
Summary of the Incidence of Neoplasms in Male Rats in the 2-Year Inhalation Study of Naphthalene

	Chamber Control	10 ppm	30 ppm	60 ppm
Urinary System				
Kidney	(49)	(49)	(48)	(49)
Schwannoma malignant, metastatic, skin			1 (2%)	
Renal tubule, carcinoma				1 (2%)
Transitional epithelium, carcinoma	1 (2%)			
Urinary bladder	(48)	(49)	(48)	(49)
Transitional epithelium, papilloma	1 (2%)			2 (4%)
Systemic Lesions				
Multiple organs ^b	(49)	(49)	(48)	(49)
Leukemia mononuclear	26 (53%)	21 (43%)	24 (50%)	17 (35%)
Mesothelioma benign	2 (4%)		1 (2%)	1 (2%)
Neoplasm Summary				
Total animals with primary neoplasms ^c	48	49	48	49
Total primary neoplasms	149	139	152	148
Total animals with benign neoplasms	46	47	47	47
Total benign neoplasms	107	96	110	108
Total animals with malignant neoplasms	34	32	34	32
Total malignant neoplasms	42	43	42	39
Total animals with metastatic neoplasms	4	3	4	2
Total metastatic neoplasms	4	3	8	2
Total animals with uncertain neoplasms— benign or malignant				1
Total uncertain neoplasms				1

^a Number of animals examined microscopically at the site and the number of animals with neoplasm

^b Number of animals with any tissue examined microscopically

^c Primary neoplasms: all neoplasms except metastatic neoplasms

TABLE A2
Individual Animal Tumor Pathology of Male Rats in the 2-Year Inhalation Study of Naphthalene: Chamber Control

Number of Days on Study	4	4	4	5	5	5	6	6	6	6	6	6	6	6	6	6	6	6	6	7	7	7	7	7	7	
Carcass ID Number	0	0	0	0	0	0	0	0	0	0	0	0	0	0	0	0	0	0	0	0	0	0	0	0	0	
	6	6	6	0	1	7	1	1	2	3	3	5	5	6	6	7	7	9	9	0	0	0	1	2	2	
	0	0	9	2	6	2	5	5	4	4	9	7	8	0	0	7	8	2	5	3	8	9	3	1	6	
Alimentary System																										
Esophagus	+	+	+	+	+	+	+	+	+	+	+	+	+	+	+	+	+	+	+	+	+	+	+	+	+	
Intestine large, colon	+	+	+	+	+	+	+	+	+	+	+	+	+	A	+	+	+	+	+	+	+	+	+	+	+	
Intestine large, rectum	+	+	+	+	+	+	+	+	+	+	+	+	+	+	+	+	+	+	+	+	+	+	+	+	+	
Intestine large, cecum	+	+	+	+	+	+	+	+	+	+	+	+	+	A	+	A	+	+	+	+	+	+	+	+	A	
Intestine small, duodenum	+	+	+	+	+	+	+	+	+	+	+	+	+	+	+	+	+	+	+	+	+	+	+	+	+	
Intestine small, jejunum	+	+	+	+	+	A	+	+	+	+	+	+	+	A	+	A	+	+	+	+	+	+	+	+	A	
Intestine small, ileum	+	+	+	+	+	A	+	+	+	+	+	+	+	A	+	A	+	+	+	+	+	+	+	+	A	
Liver	+	+	+	+	+	+	+	+	+	+	+	+	+	+	+	+	+	+	+	+	+	+	+	+	+	
Hepatocellular carcinoma																										
Hepatocellular adenoma										X																
Mesentery					+	+																				
Sarcoma																										
Pancreas	+	+	+	+	+	+	+	+	+	+	+	+	+	+	+	+	+	+	+	+	+	+	+	+	+	
Adenoma																										
Salivary glands	+	+	+	+	+	+	+	+	+	+	+	+	+	+	+	+	+	+	+	+	+	+	+	+	+	
Stomach, forestomach	+	+	+	+	+	+	+	+	+	+	+	+	+	+	+	+	+	+	+	+	+	+	+	+	+	
Stomach, glandular	+	+	+	+	+	+	+	+	+	+	+	+	+	+	+	+	+	+	+	+	+	+	+	+	+	
Tooth	+																									
Cardiovascular System																										
Heart	+	+	+	+	+	+	+	+	+	+	+	+	+	+	+	+	+	+	+	+	+	+	+	+	+	
Endocrine System																										
Adrenal cortex	+	+	+	+	+	+	+	+	+	+	+	+	+	+	+	+	+	+	+	+	+	+	+	+	+	
Adenoma														X										X		
Adrenal medulla	+	+	+	+	+	+	+	+	+	+	+	+	+	+	+	+	+	+	+	+	+	+	+	+	+	
Pheochromocytoma malignant																										
Pheochromocytoma benign														X									X			
Islets, pancreatic	+	+	+	+	+	+	+	+	+	+	+	+	+	+	+	+	+	+	+	+	+	+	+	+	+	
Adenoma																										
Carcinoma																										
Parathyroid gland	+	+	+	+	+	+	M	M	+	+	+	+	+	+	+	+	+	+	+	+	+	+	+	+	+	
Pituitary gland	+	+	+	+	+	+	+	+	+	+	+	+	+	+	+	+	+	+	+	+	+	+	+	+	+	
Pars distalis, adenoma							X	X	X	X	X	X	X	X	X	X	X	X	X	X	X	X	X	X	X	
Thyroid gland	+	+	+	+	+	+	+	M	+	+	+	+	+	+	+	A	+	+	+	+	+	+	+	+	A	
C-cell, adenoma																										
C-cell, carcinoma														X												
General Body System																										
None																										

+: Tissue examined microscopically
A: Autolysis precludes examination

M: Missing tissue
I: Insufficient tissue

X: Lesion present
Blank: Not examined

TABLE A2
Individual Animal Tumor Pathology of Male Rats in the 2-Year Inhalation Study of Naphthalene: 10 ppm

Number of Days on Study	3	4	5	5	5	5	5	5	5	6	6	6	6	6	6	6	6	6	6	6	6	6	6	6	7		
	9	3	0	0	2	2	5	6	9	0	1	4	4	4	4	6	7	7	8	8	8	8	8	9	0		
	0	5	2	5	0	5	1	7	3	0	5	3	3	3	8	5	7	8	0	1	1	4	4	5	0		
Carcass ID Number	2	2	2	2	2	2	2	2	2	2	2	2	2	2	2	2	2	2	2	2	2	2	2	2	2		
	2	4	1	3	4	1	0	4	1	2	2	0	1	2	3	2	3	4	2	1	1	0	0	4	3		
	1	2	0	9	8	8	5	3	7	8	4	6	6	9	6	2	2	6	6	1	5	2	8	4	1		
Alimentary System																											
Esophagus	+	+	+	+	+	+	+	+	+	+	+	+	+	+	+	+	+	+	+	+	+	+	+	+	+	+	
Intestine large, colon	+	+	+	+	+	+	+	+	+	+	+	+	+	+	+	+	+	+	+	+	+	+	+	+	+	+	
Intestine large, rectum	+	+	+	+	+	+	+	+	+	+	+	+	+	+	+	+	+	+	+	+	+	+	+	+	+	+	
Intestine large, cecum	+	+	+	+	+	+	+	+	+	+	+	+	+	+	+	+	+	+	+	+	+	+	+	+	+	+	
Intestine small, duodenum	+	+	A	+	+	+	+	+	+	+	+	+	+	+	+	+	+	+	+	+	+	+	+	+	+	+	
Intestine small, jejunum	+	+	A	+	+	+	A	+	+	+	+	+	+	+	+	+	+	+	+	+	+	+	+	+	+	+	
Intestine small, ileum	+	+	A	A	+	+	+	+	+	+	+	+	+	+	+	+	+	+	+	+	+	+	+	+	+	+	
Liver	+	+	+	+	+	+	+	+	+	+	+	+	+	+	+	+	+	+	+	+	+	+	+	+	+	+	
Mesentery																	+	+									
Pancreas	+	+	+	+	+	+	+	+	+	+	+	+	+	+	+	+	+	+	+	+	+	+	+	+	+	+	
Salivary glands	+	+	+	+	+	+	+	+	+	+	+	+	+	+	+	+	+	+	+	+	+	+	+	+	+	+	
Stomach, forestomach	+	+	+	+	+	+	+	+	+	+	+	+	+	+	+	+	+	+	+	+	+	+	+	+	+	+	
Stomach, glandular	+	+	+	+	+	+	+	+	+	+	+	+	+	+	+	+	+	+	+	+	+	+	+	+	+	+	
Tongue																											
Squamous cell carcinoma																											
Tooth						+									+												
Cardiovascular System																											
Heart	+	+	+	+	+	+	+	+	+	+	+	+	+	+	+	+	+	+	+	+	+	+	+	+	+	+	
Schwannoma benign																											
Endocrine System																											
Adrenal cortex	+	+	+	+	+	+	+	+	+	+	+	+	+	+	+	+	+	+	+	+	+	+	+	+	+	+	
Adrenal medulla	+	+	+	+	+	+	+	+	+	+	+	+	+	+	+	+	+	+	+	+	+	+	+	+	+	+	
Pheochromocytoma malignant																											
Pheochromocytoma benign																											
Bilateral, pheochromocytoma benign																										X	
Islets, pancreatic	+	+	+	+	+	+	+	+	+	+	+	+	+	+	+	+	+	+	+	+	+	+	+	+	+	+	
Adenoma																										X	
Carcinoma																											
Parathyroid gland	+	+	+	+	M	M	+	+	+	+	+	+	+	+	M	+	+	+	+	+	+	+	+	+	+	+	
Pituitary gland	+	+	+	+	+	+	+	+	+	+	+	+	+	+	+	+	+	+	+	+	+	+	+	+	+	+	
Pars distalis, adenoma	X	X		X	X		X	X		X	X			X	X	X					X	X	X				
Thyroid gland	+	+	A	+	+	+	A	+	+	+	+	+	+	+	+	+	+	+	+	+	+	+	+	+	+	+	
Bilateral, C-cell, adenoma																											
C-cell, adenoma							X				X																
C-cell, carcinoma															X												
Follicular cell, carcinoma																										X	
General Body System																											
Tissue NOS																											
Pheochromocytoma malignant, metastatic, adrenal medulla																											
Genital System																											
Epididymis	+	+	+	+	+	+	+	+	+	+	+	+	+	+	+	+	+	+	+	+	+	+	+	+	+	+	
Preputial gland	+	+	+	+	+	+	+	+	+	+	+	+	+	+	+	+	+	+	+	+	+	+	+	+	+	+	
Carcinoma																										X	
Prostate	+	+	+	+	+	+	+	+	+	+	+	+	+	+	+	+	+	+	+	+	+	+	+	+	+	+	
Seminal vesicle	+	+	+	+	+	+	+	+	+	+	+	+	+	+	+	+	+	+	+	+	+	+	+	+	+	+	
Testes	+	+	+	+	+	+	+	+	+	+	+	+	+	+	+	+	+	+	+	+	+	+	+	+	+	+	
Bilateral, interstitial cell, adenoma										X			X	X	X		X	X	X						X		
Interstitial cell, adenoma						X		X							X									X		X	

TABLE A2
Individual Animal Tumor Pathology of Male Rats in the 2-Year Inhalation Study of Naphthalene: 10 ppm

Number of Days on Study	3	4	5	5	5	5	5	5	5	6	6	6	6	6	6	6	6	6	6	6	6	6	6	6	6	6	7
	9	3	0	0	2	2	5	6	9	0	1	4	4	4	4	6	7	7	8	8	8	8	8	8	9	0	
	0	5	2	5	0	5	1	7	3	0	5	3	3	3	8	5	7	8	0	1	1	4	4	5	0		
Carcass ID Number	2	2	2	2	2	2	2	2	2	2	2	2	2	2	2	2	2	2	2	2	2	2	2	2	2	2	
	2	4	1	3	4	1	0	4	1	2	2	0	1	2	3	2	3	4	2	1	1	0	0	4	3		
	1	2	0	9	8	8	5	3	7	8	4	6	6	9	6	2	2	6	6	1	5	2	8	4	1		
Systemic Lesions																											
Multiple organs	+	+	+	+	+	+	+	+	+	+	+	+	+	+	+	+	+	+	+	+	+	+	+	+	+	+	
Leukemia mononuclear			X			X		X			X	X		X	X		X	X	X	X			X		X		

TABLE A3
Statistical Analysis of Primary Neoplasms in Male Rats in the 2-Year Inhalation Study of Naphthalene

	Chamber Control	10 ppm	30 ppm	60 ppm
Adrenal Medulla: Benign Pheochromocytoma				
Overall rate ^a	4/49 (8%)	7/49 (14%)	6/47 (13%)	8/49 (16%)
Adjusted rate ^b	9.7%	17.9%	15.7%	21.1%
Terminal rate ^c	1/24 (4%)	6/22 (27%)	4/23 (17%)	4/21 (19%)
First incidence (days)	639	695	681	562
Poly-3 test ^d	P=0.151	P=0.226	P=0.320	P=0.133
Adrenal Medulla: Malignant Pheochromocytoma				
Overall rate	1/49 (2%)	3/49 (6%)	1/47 (2%)	1/49 (2%)
Adjusted rate	2.4%	7.7%	2.6%	2.7%
Terminal rate	0/24 (0%)	3/22 (14%)	1/23 (4%)	1/21 (5%)
First incidence (days)	692	733 (T)	733 (T)	733 (T)
Poly-3 test	P=0.431N	P=0.287	P=0.745	P=0.736
Adrenal Medulla: Benign or Malignant Pheochromocytoma				
Overall rate	5/49 (10%)	10/49 (20%)	7/47 (15%)	8/49 (16%)
Adjusted rate	12.0%	25.6%	18.3%	21.1%
Terminal rate	1/24 (4%)	9/22 (41%)	5/23 (22%)	4/21 (19%)
First incidence (days)	639	695	681	562
Poly-3 test	P=0.331	P=0.098	P=0.321	P=0.215
Liver: Hepatocellular Adenoma				
Overall rate	1/49 (2%)	0/49 (0%)	0/48 (0%)	3/49 (6%)
Adjusted rate	2.4%	0.0%	0.0%	8.2%
Terminal rate	0/24 (0%)	0/22 (0%)	0/23 (0%)	3/21 (14%)
First incidence (days)	624	— ^e	—	733 (T)
Poly-3 test	P=0.070	P=0.511N	P=0.512N	P=0.264
Liver: Hepatocellular Adenoma or Carcinoma				
Overall rate	2/49 (4%)	0/49 (0%)	0/48 (0%)	4/49 (8%)
Adjusted rate	4.9%	0.0%	0.0%	10.8%
Terminal rate	1/24 (4%)	0/22 (0%)	0/23 (0%)	3/21 (14%)
First incidence (days)	624	—	—	632
Poly-3 test	P=0.080	P=0.249N	P=0.250N	P=0.289
Lung: Alveolar/bronchiolar Carcinoma				
Overall rate	0/49 (0%)	3/49 (6%)	0/48 (0%)	0/49 (0%)
Adjusted rate	0.0%	7.6%	0.0%	0.0%
Terminal rate	0/24 (0%)	2/22 (9%)	0/23 (0%)	0/21 (0%)
First incidence (days)	—	593	— ^f	—
Poly-3 test	P=0.242N	P=0.112	—	—
Lung: Alveolar/bronchiolar Adenoma or Carcinoma				
Overall rate	2/49 (4%)	3/49 (6%)	1/48 (2%)	0/49 (0%)
Adjusted rate	4.9%	7.6%	2.6%	0.0%
Terminal rate	2/24 (8%)	2/22 (9%)	1/23 (4%)	0/21 (0%)
First incidence (days)	733 (T)	593	733 (T)	—
Poly-3 test	P=0.102N	P=0.485	P=0.518N	P=0.261N
Mammary Gland: Fibroadenoma				
Overall rate	0/49 (0%)	0/49 (0%)	0/48 (0%)	3/49 (6%)
Adjusted rate	0.0%	0.0%	0.0%	8.2%
Terminal rate	0/24 (0%)	0/22 (0%)	0/23 (0%)	3/21 (14%)
First incidence (days)	—	—	—	733 (T)
Poly-3 test	P=0.009	—	—	P=0.100

TABLE A3
Statistical Analysis of Primary Neoplasms in Male Rats in the 2-Year Inhalation Study of Naphthalene

	Chamber Control	10 ppm	30 ppm	60 ppm
Mammary Gland: Fibroadenoma or Carcinoma				
Overall rate	1/49 (2%)	1/49 (2%)	1/48 (2%)	3/49 (6%)
Adjusted rate	2.5%	2.6%	2.6%	8.2%
Terminal rate	1/24 (4%)	1/22 (5%)	1/23 (4%)	3/21 (14%)
First incidence (days)	733 (T)	733 (T)	733 (T)	733 (T)
Poly-3 test	P=0.141	P=0.751	P=0.750	P=0.267
Nose: Adenoma				
Overall rate	0/49 (0%)	6/49 (12%)	8/48 (17%)	15/48 (31%)
Adjusted rate	0.0%	15.3%	20.6%	38.1%
Terminal rate	0/24 (0%)	5/22 (23%)	7/23 (30%)	7/21 (33%)
First incidence (days)	—	684	685	552
Poly-3 test	P<0.001	P=0.013	P=0.003	P<0.001
Nose: Neuroblastoma				
Overall rate	0/49 (0%)	0/49 (0%)	4/48 (8%)	3/48 (6%)
Adjusted rate	0.0%	0.0%	10.1%	7.7%
Terminal rate	0/24 (0%)	0/22 (0%)	2/23 (9%)	0/21 (0%)
First incidence (days)	—	—	433	399
Poly-3 test	P=0.027	—	P=0.056	P=0.109
Pancreas: Adenoma or Carcinoma				
Overall rate	1/49 (2%)	0/49 (0%)	0/48 (0%)	3/49 (6%)
Adjusted rate	2.5%	0.0%	0.0%	8.1%
Terminal rate	1/24 (4%)	0/22 (0%)	0/23 (0%)	2/21 (10%)
First incidence (days)	733 (T)	—	—	660
Poly-3 test	P=0.070	P=0.509N	P=0.510N	P=0.270
Pancreatic Islets: Adenoma				
Overall rate	2/49 (4%)	5/49 (10%)	3/48 (6%)	2/49 (4%)
Adjusted rate	4.9%	12.8%	7.6%	5.5%
Terminal rate	1/24 (4%)	4/22 (18%)	1/23 (4%)	2/21 (10%)
First incidence (days)	624	680	560	733 (T)
Poly-3 test	P=0.432N	P=0.195	P=0.484	P=0.653
Pancreatic Islets: Carcinoma				
Overall rate	4/49 (8%)	4/49 (8%)	4/48 (8%)	4/49 (8%)
Adjusted rate	9.7%	10.3%	10.2%	10.9%
Terminal rate	2/24 (8%)	4/22 (18%)	2/23 (9%)	3/21 (14%)
First incidence (days)	677	733 (T)	650	707
Poly-3 test	P=0.504	P=0.615	P=0.618	P=0.582
Pancreatic Islets: Adenoma or Carcinoma				
Overall rate	6/49 (12%)	9/49 (18%)	7/48 (15%)	6/49 (12%)
Adjusted rate	14.5%	23.0%	17.4%	16.3%
Terminal rate	3/24 (13%)	8/22 (36%)	3/23 (13%)	5/21 (24%)
First incidence (days)	624	680	560	707
Poly-3 test	P=0.504N	P=0.242	P=0.475	P=0.535
Pituitary Gland (Pars Distalis): Adenoma				
Overall rate	31/49 (63%)	31/49 (63%)	35/47 (74%)	29/49 (59%)
Adjusted rate	68.3%	68.5%	79.0%	67.0%
Terminal rate	15/24 (63%)	17/22 (77%)	17/23 (74%)	12/21 (57%)
First incidence (days)	516	390	489	469
Poly-3 test	P=0.517	P=0.583	P=0.173	P=0.543N

TABLE A3
Statistical Analysis of Primary Neoplasms in Male Rats in the 2-Year Inhalation Study of Naphthalene

	Chamber Control	10 ppm	30 ppm	60 ppm
Preputial Gland: Adenoma				
Overall rate	3/48 (6%)	0/49 (0%)	1/47 (2%)	1/49 (2%)
Adjusted rate	7.6%	0.0%	2.6%	2.7%
Terminal rate	3/23 (13%)	0/22 (0%)	0/23 (0%)	1/21 (5%)
First incidence (days)	733 (T)	—	728	733 (T)
Poly-3 test	P=0.350N	P=0.121N	P=0.319N	P=0.334N
Preputial Gland: Carcinoma				
Overall rate	3/48 (6%)	1/49 (2%)	1/47 (2%)	1/49 (2%)
Adjusted rate	7.4%	2.6%	2.6%	2.7%
Terminal rate	1/23 (4%)	0/22 (0%)	0/23 (0%)	0/21 (0%)
First incidence (days)	615	695	574	496
Poly-3 test	P=0.271N	P=0.316N	P=0.321N	P=0.333N
Preputial Gland: Adenoma or Carcinoma				
Overall rate	6/48 (13%)	1/49 (2%)	2/47 (4%)	2/49 (4%)
Adjusted rate	14.9%	2.6%	5.2%	5.4%
Terminal rate	4/23 (17%)	0/22 (0%)	0/23 (0%)	1/21 (5%)
First incidence (days)	615	695	574	496
Poly-3 test	P=0.176N	P=0.059N	P=0.145N	P=0.157N
Skin: Keratoacanthoma				
Overall rate	4/49 (8%)	3/49 (6%)	2/48 (4%)	2/49 (4%)
Adjusted rate	9.8%	7.6%	5.1%	5.4%
Terminal rate	2/24 (8%)	2/22 (9%)	1/23 (4%)	0/21 (0%)
First incidence (days)	692	567	681	659
Poly-3 test	P=0.280N	P=0.520N	P=0.360N	P=0.384N
Skin: Keratoacanthoma or Squamous Cell Carcinoma				
Overall rate	4/49 (8%)	4/49 (8%)	2/48 (4%)	2/49 (4%)
Adjusted rate	9.8%	10.1%	5.1%	5.4%
Terminal rate	2/24 (8%)	2/22 (9%)	1/23 (4%)	0/21 (0%)
First incidence (days)	692	567	681	659
Poly-3 test	P=0.230N	P=0.627	P=0.360N	P=0.384N
Skin: Keratoacanthoma, Basal Cell Adenoma, or Squamous Cell Carcinoma				
Overall rate	4/49 (8%)	5/49 (10%)	4/48 (8%)	2/49 (4%)
Adjusted rate	9.8%	12.5%	10.2%	5.4%
Terminal rate	2/24 (8%)	2/22 (9%)	2/23 (9%)	0/21 (0%)
First incidence (days)	692	567	681	659
Poly-3 test	P=0.251N	P=0.483	P=0.618	P=0.384N
Skin (Subcutaneous Tissue): Lipoma				
Overall rate	1/49 (2%)	1/49 (2%)	3/48 (6%)	0/49 (0%)
Adjusted rate	2.5%	2.6%	7.7%	0.0%
Terminal rate	0/24 (0%)	1/22 (5%)	2/23 (9%)	0/21 (0%)
First incidence (days)	709	733 (T)	710	—
Poly-3 test	P=0.469N	P=0.751	P=0.286	P=0.521N
Skin (Subcutaneous Tissue): Fibroma				
Overall rate	5/49 (10%)	2/49 (4%)	2/48 (4%)	2/49 (4%)
Adjusted rate	12.1%	5.1%	5.2%	5.5%
Terminal rate	4/24 (17%)	2/22 (9%)	2/23 (9%)	2/21 (10%)
First incidence (days)	460	733 (T)	733 (T)	733 (T)
Poly-3 test	P=0.232N	P=0.240N	P=0.243N	P=0.268N

TABLE A3
Statistical Analysis of Primary Neoplasms in Male Rats in the 2-Year Inhalation Study of Naphthalene

	Chamber Control	10 ppm	30 ppm	60 ppm
Skin (Subcutaneous Tissue): Fibrosarcoma or Sarcoma				
Overall rate	2/49 (4%)	3/49 (6%)	2/48 (4%)	2/49 (4%)
Adjusted rate	4.9%	7.6%	5.2%	5.3%
Terminal rate	1/24 (4%)	1/22 (5%)	2/23 (9%)	0/21 (0%)
First incidence (days)	678	684	733 (T)	575
Poly-3 test	P=0.534N	P=0.481	P=0.674	P=0.664
Skin (Subcutaneous Tissue): Fibroma, Fibrosarcoma, or Sarcoma				
Overall rate	7/49 (14%)	5/49 (10%)	4/48 (8%)	4/49 (8%)
Adjusted rate	16.8%	12.7%	10.3%	10.6%
Terminal rate	5/24 (21%)	3/22 (14%)	4/23 (17%)	2/21 (10%)
First incidence (days)	460	684	733 (T)	575
Poly-3 test	P=0.258N	P=0.421N	P=0.302N	P=0.320N
Testes: Adenoma				
Overall rate	38/49 (78%)	32/49 (65%)	36/48 (75%)	31/49 (63%)
Adjusted rate	85.5%	74.3%	83.5%	75.9%
Terminal rate	24/24 (100%)	17/22 (77%)	20/23 (87%)	18/21 (86%)
First incidence (days)	460	520	560	399
Poly-3 test	P=0.284N	P=0.120N	P=0.516N	P=0.162N
Thyroid Gland (C-cell): Adenoma				
Overall rate	9/46 (20%)	6/47 (13%)	4/45 (9%)	4/47 (9%)
Adjusted rate	22.8%	15.3%	10.6%	11.0%
Terminal rate	7/24 (29%)	4/22 (18%)	0/22 (0%)	2/20 (10%)
First incidence (days)	460	551	615	632
Poly-3 test	P=0.106N	P=0.289N	P=0.129N	P=0.146N
Thyroid Gland (C-cell): Adenoma or Carcinoma				
Overall rate	10/46 (22%)	8/47 (17%)	5/45 (11%)	5/47 (11%)
Adjusted rate	25.3%	20.3%	13.3%	13.8%
Terminal rate	8/24 (33%)	5/22 (23%)	1/22 (5%)	3/20 (15%)
First incidence (days)	460	551	615	632
Poly-3 test	P=0.107N	P=0.394N	P=0.145N	P=0.165N
All Organs: Mononuclear Cell Leukemia				
Overall rate	26/49 (53%)	21/49 (43%)	24/48 (50%)	17/49 (35%)
Adjusted rate	58.0%	48.3%	54.3%	43.5%
Terminal rate	12/24 (50%)	6/22 (27%)	7/23 (30%)	7/21 (33%)
First incidence (days)	469	502	560	527
Poly-3 test	P=0.169N	P=0.240N	P=0.447N	P=0.127N
All Organs: Benign Neoplasms				
Overall rate	46/49 (94%)	47/49 (96%)	47/48 (98%)	47/49 (96%)
Adjusted rate	98.2%	98.6%	99.6%	99.1%
Terminal rate	24/24 (100%)	22/22 (100%)	23/23 (100%)	21/21 (100%)
First incidence (days)	460	390	489	399
Poly-3 test	P=0.482	P=0.886	P=0.758	P=0.821
All Organs: Malignant Neoplasms				
Overall rate	34/49 (69%)	32/49 (65%)	34/48 (71%)	32/49 (65%)
Adjusted rate	74.2%	72.0%	74.1%	70.4%
Terminal rate	16/24 (67%)	13/22 (59%)	13/23 (57%)	11/21 (52%)
First incidence (days)	469	502	433	245
Poly-3 test	P=0.407N	P=0.499N	P=0.590N	P=0.428N

TABLE A3
Statistical Analysis of Primary Neoplasms in Male Rats in the 2-Year Inhalation Study of Naphthalene

	Chamber Control	10 ppm	30 ppm	60 ppm
All Organs: Benign or Malignant Neoplasms				
Overall rate	48/49 (98%)	49/49 (100%)	48/48 (100%)	49/49 (100%)
Adjusted rate	99.5%	100.0%	100.0%	100.0%
Terminal rate	24/24 (100%)	22/22 (100%)	23/23 (100%)	21/21 (100%)
First incidence (days)	460	390	433	245
Poly-3 test	P=0.941	P=0.999	P=0.999	P=0.999

(T)Terminal sacrifice

^a Number of neoplasm-bearing animals/number of animals examined. Denominator is number of animals examined microscopically for adrenal gland, liver, lung, nose, pancreas, pancreatic islets, pituitary gland, preputial gland, testis, and thyroid gland; for other tissues, denominator is number of animals necropsied.

^b Poly-3 estimated neoplasm incidence after adjustment for intercurrent mortality

^c Observed incidence at terminal kill

^d Beneath the chamber control incidence are the P values associated with the trend test. Beneath the exposed group incidence are the P values corresponding to pairwise comparisons between the chamber controls and that exposed group. The Poly-3 test accounts for differential mortality in animals that do not reach terminal sacrifice. A negative trend or a lower incidence in an exposure group is indicated by N.

^e Not applicable; no neoplasms in animal group

^f Value of statistic cannot be computed.

TABLE A4
Historical Incidence of Nasal Adenoma or Neuroblastoma in Control Male F344/N Rats

Study	Incidence in Controls
Historical Incidence in Controls Given NTP-2000 Feed^a	
<i>p,p'</i> -Dichlorodiphenyl sulfone (feed)	0/50
Indium phosphide (inhalation)	0/50
Methacrylonitrile (gavage)	0/50
Naphthalene (inhalation)	0/49
<i>p</i> -Nitrotoluene (feed)	0/50
Sodium nitrite (drinking water)	0/50
Overall Historical Incidence in Controls Given NTP-2000 Feed	
Total	0/299
Historical Incidence in Chamber Controls Given NIH-07 Feed at Battelle Pacific Northwest Laboratories^b	
Acetonitrile	0/48
2-Butoxyethanol	0/48
Chloroprene	0/50
Cobalt sulfate heptahydrate	0/50
Furfuryl alcohol	0/50
Gallium arsenide	0/50
Glutaraldehyde	0/50
Hexachlorocyclopentadiene	0/48
Isobutene	0/49
Isobutyraldehyde	0/50
Isoprene	0/50
Molybdenum trioxide	0/50
Nitromethane	0/50
Ozone	0/50
Tetrafluoroethylene	0/50
Tetrahydrofuran	0/50
Overall Historical Incidence in Chamber Controls Given NIH-07 Feed	
Total	0/1,048

^a Data as of 15 March 2000

^b Data as of 21 December 1999

TABLE A5
Summary of the Incidence of Nonneoplastic Lesions in Male Rats in the 2-Year Inhalation Study of Naphthalene^a

	Chamber Control	10 ppm	30 ppm	60 ppm
Disposition Summary				
Animals initially in study	49	49	49	49
Early deaths				
Moribund	21	22	19	25
Natural deaths	4	5	6	3
Survivors				
Terminal sacrifice	24	22	23	21
Missexed			1	
Animals examined microscopically	49	49	48	49
Alimentary System				
Liver	(49)	(49)	(48)	(49)
Angiectasis	1 (2%)	1 (2%)	1 (2%)	
Basophilic focus	34 (69%)	31 (63%)	28 (58%)	32 (65%)
Clear cell focus	14 (29%)	14 (29%)	14 (29%)	11 (22%)
Degeneration, cystic	3 (6%)	3 (6%)	2 (4%)	2 (4%)
Eosinophilic focus	3 (6%)	2 (4%)	1 (2%)	2 (4%)
Fatty change	2 (4%)	2 (4%)	4 (8%)	5 (10%)
Hepatodiaphragmatic nodule	1 (2%)	3 (6%)	2 (4%)	2 (4%)
Inflammation, granulomatous		1 (2%)		
Mixed cell focus	3 (6%)	2 (4%)	2 (4%)	2 (4%)
Necrosis			1 (2%)	
Regeneration	1 (2%)	2 (4%)	1 (2%)	1 (2%)
Syncytial alteration				1 (2%)
Tension lipidosis			1 (2%)	
Artery, inflammation	1 (2%)			
Bile duct, hyperplasia	35 (71%)	32 (65%)	28 (58%)	21 (43%)
Centrilobular, necrosis	13 (27%)	11 (22%)	7 (15%)	4 (8%)
Mesentery	(13)	(6)	(9)	(8)
Artery, inflammation, chronic active	3 (23%)			1 (13%)
Artery, mineralization			1 (11%)	
Fat, hemorrhage		1 (17%)		
Fat, inflammation		1 (17%)		
Fat, necrosis	10 (77%)	4 (67%)	8 (89%)	6 (75%)
Pancreas	(49)	(49)	(48)	(49)
Atrophy	19 (39%)	17 (35%)	17 (35%)	14 (29%)
Basophilic focus		1 (2%)	1 (2%)	1 (2%)
Hyperplasia		3 (6%)	2 (4%)	1 (2%)
Artery, inflammation	1 (2%)		1 (2%)	
Duct, cyst				1 (2%)
Salivary glands	(49)	(49)	(47)	(49)
Atrophy		1 (2%)		
Metaplasia, squamous	1 (2%)			
Necrosis	1 (2%)			
Stomach, forestomach	(49)	(49)	(48)	(49)
Diverticulum	1 (2%)			
Hyperplasia, squamous	2 (4%)	2 (4%)	2 (4%)	1 (2%)
Inflammation, acute			1 (2%)	
Necrosis				1 (2%)
Ulcer	1 (2%)	6 (12%)	3 (6%)	2 (4%)

^a Number of animals examined microscopically at the site and the number of animals with lesion

TABLE A5
Summary of the Incidence of Nonneoplastic Lesions in Male Rats in the 2-Year Inhalation Study of Naphthalene

	Chamber Control	10 ppm	30 ppm	60 ppm
Alimentary System (continued)				
Stomach, glandular	(49)	(49)	(48)	(49)
Inflammation, acute			1 (2%)	
Mineralization		2 (4%)	1 (2%)	
Necrosis	7 (14%)	2 (4%)	2 (4%)	3 (6%)
Ulcer		1 (2%)		1 (2%)
Artery, inflammation	1 (2%)			
Tongue		(1)	(1)	
Epithelium, hyperplasia			1 (100%)	
Tooth	(1)	(2)	(4)	(2)
Inflammation, chronic active	1 (100%)	1 (50%)	4 (100%)	
Malformation		1 (50%)		2 (100%)
Cardiovascular System				
Heart	(49)	(49)	(48)	(49)
Cardiomyopathy	42 (86%)	44 (90%)	37 (77%)	42 (86%)
Necrosis	1 (2%)			
Atrium, thrombosis	5 (10%)	2 (4%)	3 (6%)	2 (4%)
Valve, thrombosis, chronic		1 (2%)		
Endocrine System				
Adrenal cortex	(49)	(49)	(48)	(49)
Angiectasis	1 (2%)	1 (2%)		
Degeneration, cystic		2 (4%)	1 (2%)	1 (2%)
Hyperplasia	30 (61%)	28 (57%)	23 (48%)	36 (73%)
Hypertrophy	7 (14%)	6 (12%)	9 (19%)	4 (8%)
Necrosis		1 (2%)	2 (4%)	1 (2%)
Vacuolization cytoplasmic	1 (2%)	1 (2%)	3 (6%)	
Adrenal medulla	(49)	(49)	(47)	(49)
Hyperplasia	26 (53%)	13 (27%)	23 (49%)	12 (24%)
Necrosis		1 (2%)		
Islets, pancreatic	(49)	(49)	(48)	(49)
Hyperplasia		1 (2%)	2 (4%)	1 (2%)
Pituitary gland	(49)	(49)	(47)	(49)
Angiectasis	1 (2%)			1 (2%)
Cyst		1 (2%)		1 (2%)
Pars distalis, hyperplasia	11 (22%)	12 (24%)	10 (21%)	15 (31%)
Thyroid gland	(46)	(47)	(45)	(47)
C-cell, hyperplasia	32 (70%)	36 (77%)	31 (69%)	33 (70%)
Follicular cell, hyperplasia	2 (4%)		3 (7%)	
General Body System				
Peritoneum			(1)	
Inflammation, suppurative			1 (100%)	

TABLE A5
Summary of the Incidence of Nonneoplastic Lesions in Male Rats in the 2-Year Inhalation Study of Naphthalene

	Chamber Control	10 ppm	30 ppm	60 ppm
Genital System				
Epididymis	(49)	(49)	(48)	(49)
Angiectasis		1 (2%)		
Granuloma sperm		1 (2%)		
Preputial gland	(48)	(49)	(47)	(49)
Cyst			1 (2%)	1 (2%)
Hyperplasia, squamous	1 (2%)			
Inflammation, chronic active	2 (4%)		2 (4%)	2 (4%)
Prostate	(49)	(49)	(48)	(49)
Hyperplasia	11 (22%)	8 (16%)	16 (33%)	8 (16%)
Inflammation, chronic active	3 (6%)	2 (4%)	3 (6%)	2 (4%)
Epithelium, hyperplasia	1 (2%)			
Seminal vesicle	(47)	(49)	(47)	(47)
Inflammation, chronic active				1 (2%)
Testes	(49)	(49)	(48)	(49)
Atrophy	2 (4%)	4 (8%)	2 (4%)	4 (8%)
Artery, inflammation, chronic active		2 (4%)		2 (4%)
Interstitial cell, hyperplasia	5 (10%)	9 (18%)	2 (4%)	11 (22%)
Hematopoietic System				
Lymph node	(3)	(3)	(8)	(4)
Iliac, hemorrhage	1 (33%)			
Lymph node, mandibular	(40)	(45)	(46)	(44)
Infiltration cellular, plasma cell	1 (3%)	1 (2%)	1 (2%)	1 (2%)
Infiltration cellular, polymorphonuclear	1 (3%)			
Spleen	(49)	(49)	(48)	(49)
Fibrosis	7 (14%)	12 (24%)	6 (13%)	6 (12%)
Hematopoietic cell proliferation	4 (8%)	3 (6%)	1 (2%)	4 (8%)
Hemorrhage	3 (6%)	1 (2%)	2 (4%)	2 (4%)
Necrosis	3 (6%)	2 (4%)	1 (2%)	2 (4%)
Thrombosis	1 (2%)			1 (2%)
Integumentary System				
Mammary gland	(21)	(20)	(30)	(28)
Galactocele			1 (3%)	
Skin	(48)	(48)	(48)	(48)
Cyst epithelial inclusion			1 (2%)	
Hyperkeratosis	4 (8%)	2 (4%)		1 (2%)
Hyperplasia, basal cell			1 (2%)	
Hyperplasia, squamous				1 (2%)
Inflammation, acute		1 (2%)		
Inflammation, chronic active	4 (8%)	1 (2%)		
Epithelium, hyperplasia, basal cell	1 (2%)			
Musculoskeletal System				
Bone	(49)	(49)	(48)	(49)
Osteopetrosis			1 (2%)	

TABLE A5
Summary of the Incidence of Nonneoplastic Lesions in Male Rats in the 2-Year Inhalation Study of Naphthalene

	Chamber Control	10 ppm	30 ppm	60 ppm
Nervous System				
Brain	(49)	(49)	(48)	(49)
Degeneration	1 (2%)		1 (2%)	
Necrosis			1 (2%)	
Artery, inflammation	1 (2%)			
Respiratory System				
Larynx	(49)	(49)	(48)	(49)
Metaplasia, squamous		1 (2%)	2 (4%)	
Lung	(49)	(49)	(48)	(49)
Cyst, squamous		1 (2%)		
Foreign body	1 (2%)			1 (2%)
Hemorrhage	1 (2%)			
Inflammation, chronic active	2 (4%)	13 (27%)	6 (13%)	15 (31%)
Inflammation, granulomatous	1 (2%)			1 (2%)
Inflammation, suppurative		1 (2%)		
Metaplasia, osseous	1 (2%)			
Thrombosis	1 (2%)	1 (2%)		
Alveolar epithelium, hyperplasia	23 (47%)	12 (24%)	9 (19%)	16 (33%)
Alveolar epithelium, metaplasia	1 (2%)			
Alveolus, infiltration cellular, histiocyte	12 (24%)	9 (18%)	6 (13%)	15 (31%)
Bronchiole, hyperplasia	1 (2%)	1 (2%)		
Nose	(49)	(49)	(48)	(48)
Foreign body	1 (2%)			
Inflammation, suppurative	12 (24%)	18 (37%)	16 (33%)	9 (19%)
Thrombosis	6 (12%)	7 (14%)	6 (13%)	3 (6%)
Glands, hyperplasia	1 (2%)	49 (100%)	48 (100%)	48 (100%)
Glands, metaplasia, squamous		3 (6%)	14 (29%)	26 (54%)
Goblet cell, respiratory epithelium, hyperplasia		25 (51%)	29 (60%)	26 (54%)
Olfactory epithelium, atrophy	3 (6%)	49 (100%)	48 (100%)	47 (98%)
Olfactory epithelium, degeneration, hyaline	3 (6%)	46 (94%)	40 (83%)	38 (79%)
Olfactory epithelium, hyperplasia, atypical		48 (98%)	45 (94%)	46 (96%)
Olfactory epithelium, inflammation, chronic		49 (100%)	48 (100%)	48 (100%)
Respiratory epithelium, degeneration, hyaline		20 (41%)	19 (40%)	19 (40%)
Respiratory epithelium, hyperplasia	3 (6%)	21 (43%)	29 (60%)	29 (60%)
Respiratory epithelium, metaplasia, squamous		15 (31%)	23 (48%)	18 (38%)
Trachea	(49)	(49)	(48)	(49)
Inflammation, suppurative			1 (2%)	
Special Senses System				
Eye	(48)	(48)	(48)	(48)
Cataract	4 (8%)	2 (4%)	1 (2%)	3 (6%)
Hemorrhage				1 (2%)
Inflammation, suppurative	1 (2%)			
Retina, atrophy	2 (4%)	1 (2%)	1 (2%)	2 (4%)

TABLE A5
Summary of the Incidence of Nonneoplastic Lesions in Male Rats in the 2-Year Inhalation Study of Naphthalene

	Chamber Control	10 ppm	30 ppm	60 ppm
Urinary System				
Kidney	(49)	(49)	(48)	(49)
Infarct	3 (6%)		1 (2%)	3 (6%)
Inflammation, suppurative				1 (2%)
Metaplasia, osseous			1 (2%)	
Nephropathy	43 (88%)	44 (90%)	45 (94%)	43 (88%)
Renal tubule, hyperplasia			1 (2%)	1 (2%)
Urinary bladder	(48)	(49)	(48)	(49)
Hemorrhage	1 (2%)			
Transitional epithelium, hyperplasia				1 (2%)

APPENDIX B
SUMMARY OF LESIONS IN FEMALE RATS
IN THE 2-YEAR INHALATION STUDY
OF NAPHTHALENE

TABLE B1	Summary of the Incidence of Neoplasms in Female Rats in the 2-Year Inhalation Study of Naphthalene	97
TABLE B2	Individual Animal Tumor Pathology of Female Rats in the 2-Year Inhalation Study of Naphthalene	100
TABLE B3	Statistical Analysis of Primary Neoplasms in Female Rats in the 2-Year Inhalation Study of Naphthalene	116
TABLE B4	Historical Incidence of Nasal Adenoma or Neuroblastoma in Control Female F344/N Rats	119
TABLE B5	Summary of the Incidence of Nonneoplastic Lesions in Female Rats in the 2-Year Inhalation Study of Naphthalene	120

TABLE B1
Summary of the Incidence of Neoplasms in Female Rats in the 2-Year Inhalation Study of Naphthalene^a

	Chamber Control	10 ppm	30 ppm	60 ppm
Disposition Summary				
Animals initially in study	49	49	49	49
Early deaths				
Moribund	18	22	16	21
Natural deaths	3	6	5	4
Survivors				
Terminal sacrifice	28	21	28	24
Animals examined microscopically	49	49	49	49
Alimentary System				
Intestine large, colon	(49)	(49)	(49)	(49)
Intestine small, jejunum	(49)	(48)	(48)	(46)
Intestine small, ileum	(49)	(48)	(47)	(46)
Hepatocellular carcinoma, metastatic, liver		1 (2%)		
Liver	(49)	(49)	(49)	(49)
Hepatocellular carcinoma		1 (2%)	1 (2%)	
Mesentery	(13)	(8)	(7)	(5)
Pancreas	(49)	(49)	(49)	(49)
Salivary glands	(49)	(49)	(49)	(49)
Adenoma				1 (2%)
Stomach, forestomach	(49)	(49)	(49)	(49)
Stomach, glandular	(49)	(48)	(49)	(49)
Hepatocellular carcinoma, metastatic, liver		1 (2%)		
Tongue	(1)	(1)		(1)
Squamous cell papilloma				1 (100%)
Epithelium, squamous cell papilloma		1 (100%)		
Cardiovascular System				
Heart	(49)	(49)	(49)	(49)
Schwannoma benign			1 (2%)	
Endocrine System				
Adrenal cortex	(49)	(49)	(49)	(49)
Adenoma	1 (2%)	2 (4%)	1 (2%)	
Adrenal medulla	(48)	(49)	(49)	(49)
Pheochromocytoma benign	2 (4%)		1 (2%)	2 (4%)
Bilateral, pheochromocytoma benign	1 (2%)			
Islets, pancreatic	(49)	(49)	(49)	(49)
Adenoma	1 (2%)	1 (2%)	1 (2%)	1 (2%)
Carcinoma	1 (2%)			
Parathyroid gland	(42)	(40)	(41)	(48)
Pituitary gland	(49)	(49)	(49)	(48)
Pars distalis, adenoma	23 (47%)	27 (55%)	24 (49%)	20 (42%)
Pars distalis, carcinoma			1 (2%)	
Thyroid gland	(47)	(46)	(48)	(48)
Bilateral, C-cell, adenoma		1 (2%)		
C-cell, adenoma	4 (9%)	3 (7%)	2 (4%)	1 (2%)
C-cell, carcinoma	3 (6%)	2 (4%)	2 (4%)	
Follicular cell, carcinoma	1 (2%)			

TABLE B1
Summary of the Incidence of Neoplasms in Female Rats in the 2-Year Inhalation Study of Naphthalene

	Chamber Control	10 ppm	30 ppm	60 ppm
General Body System				
None				
Genital System				
Clitoral gland	(49)	(47)	(49)	(48)
Adenoma	3 (6%)	7 (15%)	4 (8%)	2 (4%)
Carcinoma		1 (2%)	1 (2%)	1 (2%)
Bilateral, adenoma	1 (2%)			
Ovary	(49)	(49)	(49)	(49)
Granulosa cell tumor malignant	2 (4%)	2 (4%)		
Granulosa-theca tumor malignant	1 (2%)			
Hepatocellular carcinoma, metastatic, liver		1 (2%)		
Uterus	(49)	(49)	(49)	(49)
Carcinoma			1 (2%)	
Polyp stromal	14 (29%)	5 (10%)	8 (16%)	7 (14%)
Bilateral, polyp stromal	1 (2%)	2 (4%)	1 (2%)	
Hematopoietic System				
Bone marrow	(49)	(49)	(49)	(49)
Lymph node	(2)	(3)	(2)	(3)
Lymph node, bronchial	(42)	(33)	(34)	(36)
Lymph node, mandibular	(47)	(39)	(46)	(47)
Lymph node, mesenteric	(49)	(49)	(49)	(49)
Lymph node, mediastinal	(40)	(39)	(41)	(31)
Spleen	(49)	(49)	(49)	(49)
Hemangiosarcoma	1 (2%)			
Osteosarcoma, metastatic, bone		1 (2%)		
Thymus	(46)	(45)	(48)	(41)
Integumentary System				
Mammary gland	(49)	(49)	(49)	(49)
Carcinoma	3 (6%)	5 (10%)	3 (6%)	3 (6%)
Fibroadenoma	14 (29%)	16 (33%)	17 (35%)	10 (20%)
Fibroadenoma, multiple	3 (6%)	4 (8%)	1 (2%)	4 (8%)
Skin	(49)	(49)	(49)	(49)
Basal cell adenoma			1 (2%)	
Keratoacanthoma				1 (2%)
Squamous cell papilloma	1 (2%)			
Subcutaneous tissue, fibroma			1 (2%)	1 (2%)
Subcutaneous tissue, fibrosarcoma				1 (2%)
Subcutaneous tissue, hemangioma	1 (2%)			
Subcutaneous tissue, sarcoma	1 (2%)			
Musculoskeletal System				
Bone	(49)	(49)	(49)	(49)
Osteosarcoma		1 (2%)		
Skeletal muscle		(2)		

TABLE B1
Summary of the Incidence of Neoplasms in Female Rats in the 2-Year Inhalation Study of Naphthalene

	Chamber Control	10 ppm	30 ppm	60 ppm
Nervous System				
Brain	(49)	(49)	(49)	(49)
Carcinoma, metastatic, pituitary gland			1 (2%)	
Glioma malignant			1 (2%)	
Neuroblastoma, metastatic, nose		1 (2%)		4 (8%)
Respiratory System				
Larynx	(49)	(49)	(49)	(49)
Lung	(49)	(49)	(49)	(49)
Alveolar/bronchiolar adenoma	1 (2%)			
Carcinoma, metastatic, Zymbal's gland		1 (2%)		
Hepatocellular carcinoma, metastatic, liver		1 (2%)		
Osteosarcoma, metastatic, bone		1 (2%)		
Nose	(49)	(49)	(49)	(49)
Olfactory epithelium, neuroblastoma		2 (4%)	3 (6%)	12 (24%)
Respiratory epithelium, adenoma			4 (8%)	2 (4%)
Special Senses System				
Zymbal's gland	(2)	(1)		
Carcinoma	2 (100%)	1 (100%)		
Urinary System				
Kidney	(48)	(49)	(49)	(49)
Renal tubule, carcinoma	1 (2%)			
Urinary bladder	(48)	(49)	(49)	(49)
Transitional epithelium, papilloma	1 (2%)		1 (2%)	
Systemic Lesions				
Multiple organs ^a	(49)	(49)	(49)	(49)
Leukemia mononuclear	16 (33%)	21 (43%)	15 (31%)	15 (31%)
Mesothelioma benign			1 (2%)	
Neoplasm Summary				
Total animals with primary neoplasms ^c	44	48	47	44
Total primary neoplasms	104	106	97	89
Total animals with benign neoplasms	38	41	43	35
Total benign neoplasms	72	69	69	53
Total animals with malignant neoplasms	26	34	26	27
Total malignant neoplasms	32	37	28	36
Total animals with metastatic neoplasms		3	1	
Total metastatic neoplasms		7	1	

^a Number of animals examined microscopically at the site and the number of animals with neoplasm

^b Number of animals with any tissue examined microscopically

^c Primary neoplasms: all neoplasms except metastatic neoplasms

TABLE B2
Individual Animal Tumor Pathology of Female Rats in the 2-Year Inhalation Study of Naphthalene: Chamber Control

Number of Days on Study	5	5	5	6	6	6	6	6	6	6	6	6	6	6	6	7	7	7	7	7	7	7	7	7	7	7	7
Carcass ID Number	0	1	7	0	0	2	5	5	7	7	7	7	7	7	8	9	0	0	1	2	2	3	3	3	3	3	3
Carcass ID Number	9	9	2	2	4	5	7	7	1	1	1	6	7	9	4	0	5	7	3	5	7	4	4	4	4	4	
Alimentary System																											
Esophagus	+																										
Intestine large, colon	+																										
Intestine large, rectum	+ I +																										
Intestine large, cecum	+ +																										
Intestine small, duodenum	+ +																										
Intestine small, jejunum	+ +																										
Intestine small, ileum	+ +																										
Liver	+ +																										
Mesentery	+ +																										
Pancreas	+ +																										
Salivary glands	+ +																										
Stomach, forestomach	+ +																										
Stomach, glandular	+ +																										
Tongue	+ +																										
	+																										
Cardiovascular System																											
Heart	+ +																										
Endocrine System																											
Adrenal cortex	+ +																										
Adenoma																											
Adrenal medulla	+ + + + + + + + + + + + + + + M + + + + + + + + + + + + + + + +																										
Pheochromocytoma benign																											
Bilateral, pheochromocytoma benign	X																										
Islets, pancreatic	+ +																										
Adenoma																											
Carcinoma	X																										
Parathyroid gland	+ + + + + M + + + + + + + + + + + + + + + M + M M + +																										
Pituitary gland	+ +																										
Pars distalis, adenoma	X X X X X X X X X X X X																										
Thyroid gland	+ + + + + A + + + + + + + + + + + + + + + A + + + + +																										
C-cell, adenoma	X																										
C-cell, carcinoma	X																										
Follicular cell, carcinoma	X																										
General Body System																											
None																											
Genital System																											
Clitoral gland	+ +																										
Adenoma																											
Bilateral, adenoma	X																										
Ovary	+ +																										
Granulosa cell tumor malignant	X																										
Granulosa-theca tumor malignant																											
Uterus	+ +																										
Polyp stromal	X X X X X X X																										
Bilateral, polyp stromal																											

+: Tissue examined microscopically
 A: Autolysis precludes examination

M: Missing tissue
 I: Insufficient tissue

X: Lesion present
 Blank: Not examined

TABLE B2
Individual Animal Tumor Pathology of Female Rats in the 2-Year Inhalation Study of Naphthalene: Chamber Control

Table with 20 columns and 100+ rows. Columns include 'Number of Days on Study' (top row), 'Carcass ID Number' (second row), and various organ systems (e.g., Hematopoietic, Integumentary, Musculoskeletal, Nervous, Respiratory, Special Senses, Urinary, Systemic Lesions). The bottom row shows 'Total Tissues/Tumors' for each system. Data is represented by '+' for presence and 'X' for absence of a tumor.

TABLE B2
Individual Animal Tumor Pathology of Female Rats in the 2-Year Inhalation Study of Naphthalene: 10 ppm

Number of Days on Study	4	4	5	5	5	5	5	5	5	5	6	6	6	6	6	6	6	6	6	6	6	6	6	7
	4	7	0	0	1	7	7	8	8	8	0	0	2	2	3	4	6	6	7	7	7	7	9	1
	0	1	3	9	8	4	7	1	1	7	2	9	2	5	5	7	3	5	7	7	7	9	9	3
Carcass ID Number	3	3	3	3	3	3	3	3	3	3	3	3	3	3	3	3	3	3	3	3	3	3	3	3
	1	3	4	3	4	3	1	0	2	1	3	0	3	2	3	1	1	1	0	2	4	4	4	1
	4	4	6	0	1	7	2	2	7	5	2	9	8	9	5	6	3	0	4	6	8	0	7	1
Hematopoietic System																								
Bone marrow	+	+	+	+	+	+	+	+	+	+	+	+	+	+	+	+	+	+	+	+	+	+	+	+
Lymph node																								+
Lymph node, bronchial	+	+	+	M	+	M	M	+	+	M	M	M	+	+	M	+	+	+	+	+	+	+	+	+
Lymph node, mandibular	+	+	M	+	+	M	+	+	+	+	+	+	+	+	M	+	M	+	+	+	+	+	+	+
Lymph node, mesenteric	+	+	+	+	+	+	+	+	+	+	+	+	+	+	+	+	+	+	+	+	+	+	+	+
Lymph node, mediastinal	+	+	+	+	+	+	M	+	+	M	M	M	+	+	M	+	+	+	+	+	+	+	+	M
Spleen	+	+	+	+	+	+	+	+	+	+	+	+	+	+	+	+	+	+	+	+	+	+	+	+
Osteosarcoma, metastatic, bone	X																							
Thymus	+	+	+	+	+	+	+	+	+	+	M	+	+	+	+	+	+	+	+	+	+	+	+	M
Integumentary System																								
Mammary gland	+	+	+	+	+	+	+	+	+	+	+	+	+	+	+	+	+	+	+	+	+	+	+	+
Carcinoma							X			X	X													
Fibroadenoma									X				X	X				X	X					
Fibroadenoma, multiple																		X						
Skin	+	+	+	+	+	+	+	+	+	+	+	+	+	+	+	+	+	+	+	+	+	+	+	+
Musculoskeletal System																								
Bone	+	+	+	+	+	+	+	+	+	+	+	+	+	+	+	+	+	+	+	+	+	+	+	+
Osteosarcoma	X																							
Skeletal muscle																								
Nervous System																								
Brain	+	+	+	+	+	+	+	+	+	+	+	+	+	+	+	+	+	+	+	+	+	+	+	+
Neuroblastoma, metastatic, nose																								
Respiratory System																								
Larynx	+	+	+	+	+	+	+	+	+	+	+	+	+	+	+	+	+	+	+	+	+	+	+	+
Lung	+	+	+	+	+	+	+	+	+	+	+	+	+	+	+	+	+	+	+	+	+	+	+	+
Carcinoma, metastatic, Zymbal's gland																								
Hepatocellular carcinoma, metastatic, liver																			X					
Osteosarcoma, metastatic, bone	X																							
Nose	+	+	+	+	+	+	+	+	+	+	+	+	+	+	+	+	+	+	+	+	+	+	+	+
Olfactory epithelium, neuroblastoma																								X
Trachea	+	+	+	+	+	+	+	+	+	+	+	+	+	+	+	+	+	+	+	+	+	+	+	+
Special Senses System																								
Eye	+	+	+	+	+	+	+	+	+	+	+	+	+	+	+	+	+	+	+	+	+	+	+	+
Zymbal's gland																								
Carcinoma																								
Urinary System																								
Kidney	+	+	+	+	+	+	+	+	+	+	+	+	+	+	+	+	+	+	+	+	+	+	+	+
Urinary bladder	+	+	+	+	+	+	+	+	+	+	+	+	+	+	+	+	+	+	+	+	+	+	+	+
Systemic Lesions																								
Multiple organs	+	+	+	+	+	+	+	+	+	+	+	+	+	+	+	+	+	+	+	+	+	+	+	+
Leukemia mononuclear		X	X		X	X	X						X	X	X	X	X	X	X			X	X	

TABLE B2
Individual Animal Tumor Pathology of Female Rats in the 2-Year Inhalation Study of Naphthalene: 60 ppm

Number of Days on Study	1	4	4	4	4	5	5	5	5	5	6	6	6	6	6	6	6	6	6	6	6	6	6	7	7		
	1	2	4	7	8	0	3	4	5	7	0	1	2	2	2	4	4	5	6	7	8	8	8	2	2		
	1	9	5	8	2	3	6	7	5	9	1	7	4	5	5	2	3	6	7	7	0	4	5	0	2		
Carcass ID Number	7	7	7	7	7	7	7	7	7	7	7	7	7	7	7	7	7	7	7	7	7	7	7	7	7		
	2	1	3	2	3	3	3	0	2	0	3	1	0	1	3	4	3	3	1	2	2	1	0	2	0		
	2	7	4	3	6	0	9	1	9	2	1	2	4	0	5	1	7	3	6	0	7	4	6	8	9		
Hematopoietic System																											
Bone marrow	+	+	+	+	+	+	+	+	+	+	+	+	+	+	+	+	+	+	+	+	+	+	+	+	+	+	
Lymph node																										+	
Lymph node, bronchial	+	+	M	+	+	+	+	+	+	+	+	+	+	+	M	M	+	+	+	+	M	M	+	+	+	+	
Lymph node, mandibular	+	+	M	+	+	+	+	+	+	M	+	+	+	+	+	+	+	+	+	+	+	+	+	+	+	+	
Lymph node, mesenteric	+	+	+	+	+	+	+	+	+	+	+	+	+	+	+	+	+	+	+	+	+	+	+	+	+	+	
Lymph node, mediastinal	M	M	+	+	+	+	+	+	M	M	M	+	+	+	+	M	+	+	M	M	+	M	+	+	+	+	
Spleen	+	+	+	+	+	+	+	+	+	+	+	+	+	+	+	+	+	+	+	+	+	+	+	+	+	+	
Thymus	+	+	+	M	M	+	+	+	+	M	M	+	+	+	+	+	+	+	+	+	M	+	+	+	M	+	
Integumentary System																											
Mammary gland	+	+	+	+	+	+	+	+	+	+	+	+	+	+	+	+	+	+	+	+	+	+	+	+	+	+	
Carcinoma						X						X															
Fibroadenoma																X						X	X				
Fibroadenoma, multiple																										X	
Skin	+	+	+	+	+	+	+	+	+	+	+	+	+	+	+	+	+	+	+	+	+	+	+	+	+	+	
Keratoacanthoma																								X			
Subcutaneous tissue, fibroma																											
Subcutaneous tissue, fibrosarcoma																										X	
Musculoskeletal System																											
Bone	+	+	+	+	+	+	+	+	+	+	+	+	+	+	+	+	+	+	+	+	+	+	+	+	+	+	
Nervous System																											
Brain	+	+	+	+	+	+	+	+	+	+	+	+	+	+	+	+	+	+	+	+	+	+	+	+	+	+	
Neuroblastoma, metastatic, nose			X	X																	X	X					
Respiratory System																											
Larynx	+	+	+	+	+	+	+	+	+	+	+	+	+	+	+	+	+	+	+	+	+	+	+	+	+	+	
Lung	+	+	+	+	+	+	+	+	+	+	+	+	+	+	+	+	+	+	+	+	+	+	+	+	+	+	
Nose	+	+	+	+	+	+	+	+	+	+	+	+	+	+	+	+	+	+	+	+	+	+	+	+	+	+	
Olfactory epithelium, neuroblastoma			X	X			X	X	X			X	X					X	X								
Respiratory epithelium, adenoma									X																		
Trachea	+	+	+	+	+	+	+	+	+	+	+	+	+	+	+	+	+	+	+	+	+	+	+	+	+	+	
Special Senses System																											
Eye	+	+	+		+	+	+	+	+	+	+	+	+	+	+	+	+	+	+	+	+	+	+	+	+	+	
Harderian gland				+																							
Urinary System																											
Kidney	+	+	+	+	+	+	+	+	+	+	+	+	+	+	+	+	+	+	+	+	+	+	+	+	+	+	
Urinary bladder	+	+	+	+	+	+	+	+	+	+	+	+	+	+	+	+	+	+	+	+	+	+	+	+	+	+	
Systemic Lesions																											
Multiple rgans	+	+	+	+	+	+	+	+	+	+	+	+	+	+	+	+	+	+	+	+	+	+	+	+	+	+	
Leukemia mononuclear				X					X		X	X	X			X	X						X	X		X	

TABLE B3
Statistical Analysis of Primary Neoplasms in Female Rats in the 2-Year Inhalation Study of Naphthalene

	Chamber Control	10 ppm	30 ppm	60 ppm
Adrenal Medulla: Benign Pheochromocytoma				
Overall rate ^a	3/48 (6%)	0/49 (0%)	1/49 (2%)	2/49 (4%)
Adjusted rate ^b	7.0%	0.0%	2.4%	5.3%
Terminal rate ^c	2/28 (7%)	0/21 (0%)	0/28 (0%)	2/24 (8%)
First incidence (days)	676	— ^e	671	734 (T)
Poly-3 test ^d	P=0.598N	P=0.137N	P=0.319N	P=0.554N
Clitoral Gland: Adenoma				
Overall rate	4/49 (8%)	7/47 (15%)	4/49 (8%)	2/48 (4%)
Adjusted rate	9.3%	18.1%	9.7%	5.2%
Terminal rate	4/28 (14%)	4/21 (19%)	3/28 (11%)	0/24 (0%)
First incidence (days)	734 (T)	518	615	617
Poly-3 test	P=0.168N	P=0.198	P=0.617	P=0.392N
Clitoral Gland: Adenoma or Carcinoma				
Overall rate	4/49 (8%)	7/47 (15%)	5/49 (10%)	3/48 (6%)
Adjusted rate	9.3%	18.1%	11.9%	7.8%
Terminal rate	4/28 (14%)	4/21 (19%)	3/28 (11%)	1/24 (4%)
First incidence (days)	734 (T)	518	440	617
Poly-3 test	P=0.316N	P=0.198	P=0.481	P=0.564N
Mammary Gland: Fibroadenoma				
Overall rate	17/49 (35%)	20/49 (41%)	18/49 (37%)	14/49 (29%)
Adjusted rate	38.5%	49.1%	41.2%	36.1%
Terminal rate	12/28 (43%)	12/21 (57%)	10/28 (36%)	10/24 (42%)
First incidence (days)	625	581	440	625
Poly-3 test	P=0.319N	P=0.216	P=0.484	P=0.503N
Mammary Gland: Carcinoma				
Overall rate	3/49 (6%)	5/49 (10%)	3/49 (6%)	3/49 (6%)
Adjusted rate	6.9%	12.4%	7.2%	7.7%
Terminal rate	3/28 (11%)	1/21 (5%)	1/28 (4%)	1/24 (4%)
First incidence (days)	734 (T)	577	587	503
Poly-3 test	P=0.478N	P=0.315	P=0.643	P=0.614
Mammary Gland: Fibroadenoma or Carcinoma				
Overall rate	18/49 (37%)	24/49 (49%)	19/49 (39%)	17/49 (35%)
Adjusted rate	40.7%	56.9%	43.5%	42.7%
Terminal rate	13/28 (46%)	12/21 (57%)	11/28 (39%)	11/24 (46%)
First incidence (days)	625	577	440	503
Poly-3 test	P=0.379N	P=0.092	P=0.483	P=0.517
Nose: Adenoma				
Overall rate	0/49 (0%)	0/49 (0%)	4/49 (8%)	2/49 (4%)
Adjusted rate	0.0%	0.0%	9.8%	5.2%
Terminal rate	0/28 (0%)	0/21 (0%)	3/28 (11%)	1/24 (4%)
First incidence (days)	—	— ^f	721	555
Poly-3 test	P=0.066	— ^f	P=0.053	P=0.212
Nose: Neuroblastoma				
Overall rate	0/49 (0%)	2/49 (4%)	3/49 (6%)	12/49 (24%)
Adjusted rate	0.0%	5.1%	7.2%	28.2%
Terminal rate	0/28 (0%)	0/21 (0%)	1/28 (4%)	3/24 (13%)
First incidence (days)	—	679	480	429
Poly-3 test	P<0.001	P=0.214	P=0.112	P<0.001

TABLE B3
Statistical Analysis of Primary Neoplasms in Female Rats in the 2-Year Inhalation Study of Naphthalene

	Chamber Control	10 ppm	30 ppm	60 ppm
Pituitary Gland (Pars Distalis): Adenoma				
Overall rate	23/49 (47%)	27/49 (55%)	24/49 (49%)	20/48 (42%)
Adjusted rate	49.5%	61.2%	54.2%	48.1%
Terminal rate	12/28 (43%)	14/21 (67%)	14/28 (50%)	11/24 (46%)
First incidence (days)	509	509	581	482
Poly-3 test	P=0.335N	P=0.176	P=0.405	P=0.534N
Pituitary Gland (Pars Distalis): Adenoma or Carcinoma				
Overall rate	23/49 (47%)	27/49 (55%)	25/49 (51%)	20/48 (42%)
Adjusted rate	49.5%	61.2%	56.4%	48.1%
Terminal rate	12/28 (43%)	14/21 (67%)	14/28 (50%)	11/24 (46%)
First incidence (days)	509	509	581	482
Poly-3 test	P=0.351N	P=0.176	P=0.325	P=0.534N
Thyroid Gland (C-cell): Adenoma				
Overall rate	4/47 (9%)	4/46 (9%)	2/48 (4%)	1/48 (2%)
Adjusted rate	9.4%	10.8%	5.0%	2.7%
Terminal rate	1/28 (4%)	3/21 (14%)	2/28 (7%)	1/24 (4%)
First incidence (days)	602	677	734 (T)	734 (T)
Poly-3 test	P=0.106N	P=0.569	P=0.366N	P=0.223N
Thyroid Gland (C-cell): Carcinoma				
Overall rate	3/47 (6%)	2/46 (4%)	2/48 (4%)	0/48 (0%)
Adjusted rate	7.2%	5.4%	5.0%	0.0%
Terminal rate	2/28 (7%)	2/21 (10%)	2/28 (7%)	0/24 (0%)
First incidence (days)	690	734 (T)	734 (T)	—
Poly-3 test	P=0.102N	P=0.557N	P=0.523N	P=0.142N
Thyroid Gland (C-cell): Adenoma or Carcinoma				
Overall rate	7/47 (15%)	6/46 (13%)	4/48 (8%)	1/48 (2%)
Adjusted rate	16.4%	16.1%	10.0%	2.7%
Terminal rate	3/28 (11%)	5/21 (24%)	4/28 (14%)	1/24 (4%)
First incidence (days)	602	677	734 (T)	734 (T)
Poly-3 test	P=0.024N	P=0.606N	P=0.299N	P=0.047N
Uterus: Stromal Polyp				
Overall rate	15/49 (31%)	7/49 (14%)	9/49 (18%)	7/49 (14%)
Adjusted rate	33.1%	17.8%	21.4%	18.3%
Terminal rate	9/28 (32%)	4/21 (19%)	7/28 (25%)	6/24 (25%)
First incidence (days)	519	635	480	667
Poly-3 test	P=0.118N	P=0.085N	P=0.162N	P=0.099N
All Organs: Mononuclear Cell Leukemia				
Overall rate	16/49 (33%)	21/49 (43%)	15/49 (31%)	15/49 (31%)
Adjusted rate	34.6%	48.2%	35.1%	36.4%
Terminal rate	3/28 (11%)	7/21 (33%)	8/28 (29%)	6/24 (25%)
First incidence (days)	572	471	587	478
Poly-3 test	P=0.398N	P=0.134	P=0.569	P=0.519
All Organs: Benign Neoplasms				
Overall rate	38/49 (78%)	41/49 (84%)	43/49 (88%)	35/49 (71%)
Adjusted rate	79.3%	89.1%	90.4%	80.3%
Terminal rate	22/28 (79%)	19/21 (91%)	24/28 (86%)	19/24 (79%)
First incidence (days)	509	509	440	482
Poly-3 test	P=0.507N	P=0.141	P=0.100	P=0.558

TABLE B3
Statistical Analysis of Primary Neoplasms in Female Rats in the 2-Year Inhalation Study of Naphthalene

	Chamber Control	10 ppm	30 ppm	60 ppm
All Organs: Malignant Neoplasms				
Overall rate	26/49 (53%)	34/49 (69%)	26/49 (53%)	27/49 (55%)
Adjusted rate	56.0%	73.5%	56.5%	58.9%
Terminal rate	12/28 (43%)	12/21 (57%)	12/28 (43%)	9/24 (38%)
First incidence (days)	572	440	440	429
Poly-3 test	P=0.349N	P=0.055	P=0.563	P=0.472
All Organs: Benign or Malignant Neoplasms				
Overall rate	44/49 (90%)	48/49 (98%)	47/49 (96%)	44/49 (90%)
Adjusted rate	90.6%	98.0%	97.5%	91.7%
Terminal rate	24/28 (86%)	20/21 (95%)	27/28 (96%)	20/24 (83%)
First incidence (days)	509	440	440	429
Poly-3 test	P=0.479N	P=0.124	P=0.151	P=0.571

(T)Terminal sacrifice

^a Number of neoplasm-bearing animals/number of animals examined. Denominator is number of animals examined microscopically for adrenal gland, clitoral gland, nose, pituitary gland, and thyroid gland; for other tissues, denominator is number of animals necropsied.

^b Poly-3 estimated neoplasm incidence after adjustment for intercurrent mortality

^c Observed incidence at terminal kill

^d Beneath the chamber control incidence are the P values associated with the trend test. Beneath the exposed group incidence are the P values corresponding to pairwise comparisons between the chamber controls and that exposed group. The Poly-3 test accounts for differential mortality in animals that do not reach terminal sacrifice. A negative trend or a lower incidence in an exposure group is indicated by N.

^e Not applicable; no neoplasms in animal group

^f Value of statistic cannot be computed.

TABLE B4
Historical Incidence of Nasal Adenoma or Neuroblastoma in Control Female F344/N Rats

Study	Incidence in Controls
Historical Incidence in Controls Given NTP-2000 Feed^a	
<i>p,p'</i> -Dichlorodiphenyl sulfone (feed)	0/50
Indium phosphide (inhalation)	0/50
Methacrylonitrile (gavage)	0/50
Naphthalene (inhalation)	0/49
<i>p</i> -Nitrotoluene (feed)	0/50
Sodium nitrite (drinking water)	0/50
Overall Historical Incidence in Controls Given NTP-2000 Feed	
Total	0/299
Historical Incidence in Chamber Controls Given NIH-07 Feed at Battelle Pacific Northwest Laboratories^b	
Acetonitrile	0/47
2-Butoxyethanol	0/50
Chloroprene	0/49
Cobalt sulfate heptahydrate	0/50
Furfuryl alcohol	0/49
Gallium arsenide	0/50
Glutaraldehyde	0/50
Hexachlorocyclopentadiene	0/50
Isobutene	0/50
Isobutyraldehyde	0/49
Isoprene	0/50
Molybdenum trioxide	0/48
Nitromethane	0/50
Ozone	0/50
Tetrafluoroethylene	0/50
Tetrahydrofuran	0/49
Overall Historical Incidence in Chamber Controls Given NIH-07 Feed	
Total	0/1,044

^a Data as of 15 March 2000

^b Data as of 21 December 1999

TABLE B5
Summary of the Incidence of Nonneoplastic Lesions in Female Rats in the 2-Year Inhalation Study of Naphthalene^a

	Chamber Control	10 ppm	30 ppm	60 ppm
Disposition Summary				
Animals initially in study	49	49	49	49
Early deaths				
Moribund	18	22	16	21
Natural deaths	3	6	5	4
Survivors				
Terminal sacrifice	28	21	28	24
Animals examined microscopically	49	49	49	49
Alimentary System				
Intestine large, cecum	(49)	(48)	(48)	(48)
Inflammation, acute				1 (2%)
Liver	(49)	(49)	(49)	(49)
Angiectasis	2 (4%)	4 (8%)	2 (4%)	1 (2%)
Basophilic focus	46 (94%)	44 (90%)	46 (94%)	44 (90%)
Clear cell focus	7 (14%)	16 (33%)	8 (16%)	6 (12%)
Cyst				1 (2%)
Eosinophilic focus	1 (2%)		6 (12%)	2 (4%)
Fatty change	10 (20%)	3 (6%)	2 (4%)	4 (8%)
Hepatodiaphragmatic nodule	4 (8%)	1 (2%)	6 (12%)	5 (10%)
Inflammation, chronic	2 (4%)			
Mixed cell focus	6 (12%)	6 (12%)	7 (14%)	6 (12%)
Necrosis	1 (2%)	1 (2%)	1 (2%)	
Regeneration	1 (2%)	2 (4%)	2 (4%)	2 (4%)
Vacuolization cytoplasmic, focal	1 (2%)	1 (2%)		
Bile duct, hyperplasia	5 (10%)	5 (10%)	5 (10%)	6 (12%)
Centrilobular, necrosis	11 (22%)	11 (22%)	7 (14%)	9 (18%)
Hepatocyte, atrophy			1 (2%)	
Mesentery	(13)	(8)	(7)	(5)
Fat, hemorrhage	1 (8%)			
Fat, inflammation		1 (13%)		
Fat, necrosis	13 (100%)	7 (88%)	6 (86%)	5 (100%)
Pancreas	(49)	(49)	(49)	(49)
Atrophy	18 (37%)	9 (18%)	11 (22%)	10 (20%)
Basophilic focus		1 (2%)	1 (2%)	
Hyperplasia		1 (2%)		
Duct, cyst		1 (2%)		
Salivary glands	(49)	(49)	(49)	(49)
Atrophy	1 (2%)			2 (4%)
Basophilic focus	1 (2%)			
Stomach, forestomach	(49)	(49)	(49)	(49)
Hyperplasia, squamous				1 (2%)
Inflammation, acute	1 (2%)			
Ulcer	3 (6%)	2 (4%)	2 (4%)	

^a Number of animals examined microscopically at the site and the number of animals with lesion

TABLE B5
Summary of the Incidence of Nonneoplastic Lesions in Female Rats in the 2-Year Inhalation Study of Naphthalene

	Chamber Control	10 ppm	30 ppm	60 ppm
Alimentary System (continued)				
Stomach, glandular	(49)	(48)	(49)	(49)
Hyperplasia			1 (2%)	
Mineralization	2 (4%)	2 (4%)		2 (4%)
Necrosis	3 (6%)	2 (4%)	1 (2%)	
Ulcer	1 (2%)		1 (2%)	
Tongue	(1)	(1)		(1)
Epithelium, hyperplasia	1 (100%)			
Tooth			(1)	(1)
Malformation			1 (100%)	1 (100%)
Cardiovascular System				
Heart	(49)	(49)	(49)	(49)
Cardiomyopathy	32 (65%)	31 (63%)	31 (63%)	34 (69%)
Atrium, thrombosis	2 (4%)	2 (4%)	1 (2%)	1 (2%)
Endocrine System				
Adrenal cortex	(49)	(49)	(49)	(49)
Atrophy	2 (4%)			
Degeneration, cystic	4 (8%)	4 (8%)	3 (6%)	3 (6%)
Hyperplasia	23 (47%)	12 (24%)	18 (37%)	24 (49%)
Hypertrophy	7 (14%)	4 (8%)	12 (24%)	6 (12%)
Necrosis	4 (8%)	2 (4%)		1 (2%)
Thrombosis	1 (2%)			
Vacuolization cytoplasmic		2 (4%)		1 (2%)
Adrenal medulla	(48)	(49)	(49)	(49)
Hyperplasia	10 (21%)	3 (6%)	9 (18%)	5 (10%)
Necrosis	2 (4%)	1 (2%)		
Thrombosis	1 (2%)			
Islets, pancreatic	(49)	(49)	(49)	(49)
Hyperplasia			1 (2%)	
Parathyroid gland	(42)	(40)	(41)	(48)
Hyperplasia			1 (2%)	
Pituitary gland	(49)	(49)	(49)	(48)
Angiectasis	2 (4%)	2 (4%)	3 (6%)	2 (4%)
Cyst				1 (2%)
Pars distalis, hyperplasia	24 (49%)	13 (27%)	18 (37%)	15 (31%)
Thyroid gland	(47)	(46)	(48)	(48)
C-cell, hyperplasia	39 (83%)	37 (80%)	37 (77%)	42 (88%)
Follicular cell, hyperplasia			1 (2%)	
General Body System				
None				

TABLE B5
Summary of the Incidence of Nonneoplastic Lesions in Female Rats in the 2-Year Inhalation Study of Naphthalene

	Chamber Control	10 ppm	30 ppm	60 ppm
Genital System				
Clitoral gland	(49)	(47)	(49)	(48)
Hyperplasia	1 (2%)	2 (4%)	2 (4%)	3 (6%)
Inflammation, chronic active	2 (4%)		1 (2%)	1 (2%)
Ovary	(49)	(49)	(49)	(49)
Cyst	7 (14%)	9 (18%)	11 (22%)	8 (16%)
Inflammation, granulomatous	1 (2%)	1 (2%)		2 (4%)
Uterus	(49)	(49)	(49)	(49)
Cyst	1 (2%)			
Vagina			(1)	
Inflammation, suppurative			1 (100%)	
Hematopoietic System				
Bone marrow	(49)	(49)	(49)	(49)
Atrophy				1 (2%)
Hyperplasia, reticulum cell	1 (2%)		1 (2%)	
Myelofibrosis	1 (2%)			
Lymph node, mediastinal	(40)	(39)	(41)	(31)
Congestion			1 (2%)	
Hemorrhage			1 (2%)	
Spleen	(49)	(49)	(49)	(49)
Fibrosis	3 (6%)	3 (6%)	3 (6%)	2 (4%)
Hematopoietic cell proliferation	2 (4%)	4 (8%)	1 (2%)	4 (8%)
Hemorrhage		2 (4%)		1 (2%)
Metaplasia, osseous				1 (2%)
Necrosis	2 (4%)	1 (2%)	1 (2%)	1 (2%)
Thymus	(46)	(45)	(48)	(41)
Cyst			1 (2%)	
Integumentary System				
Mammary gland	(49)	(49)	(49)	(49)
Galactocele	1 (2%)	2 (4%)	1 (2%)	1 (2%)
Hyperplasia, atypical				1 (2%)
Inflammation, chronic active	2 (4%)			
Skin	(49)	(49)	(49)	(49)
Hyperkeratosis				1 (2%)
Inflammation, acute				2 (4%)
Inflammation, chronic active	1 (2%)			
Epidermis, hyperplasia	1 (2%)			
Subcutaneous tissue, hemorrhage		1 (2%)		
Musculoskeletal System				
Bone	(49)	(49)	(49)	(49)
Osteopetrosis	10 (20%)	4 (8%)	7 (14%)	5 (10%)

TABLE B5
Summary of the Incidence of Nonneoplastic Lesions in Female Rats in the 2-Year Inhalation Study of Naphthalene

	Chamber Control	10 ppm	30 ppm	60 ppm
Nervous System				
Brain	(49)	(49)	(49)	(49)
Angiectasis			1 (2%)	
Degeneration	1 (2%)			
Thrombosis	1 (2%)			
Respiratory System				
Larynx	(49)	(49)	(49)	(49)
Hyperplasia				1 (2%)
Metaplasia, squamous	2 (4%)		4 (8%)	1 (2%)
Lung	(49)	(49)	(49)	(49)
Congestion, chronic			1 (2%)	
Inflammation, chronic active	16 (33%)	15 (31%)	19 (39%)	22 (45%)
Metaplasia, osseous			1 (2%)	
Alveolar epithelium, hyperplasia	4 (8%)	11 (22%)	11 (22%)	9 (18%)
Alveolus, infiltration cellular, histiocyte	19 (39%)	7 (14%)	11 (22%)	14 (29%)
Bronchiole, hyperplasia	1 (2%)	1 (2%)	1 (2%)	1 (2%)
Nose	(49)	(49)	(49)	(49)
Inflammation, suppurative	2 (4%)	5 (10%)	5 (10%)	5 (10%)
Thrombosis	7 (14%)	4 (8%)	3 (6%)	3 (6%)
Glands, hyperplasia		48 (98%)	48 (98%)	42 (86%)
Glands, metaplasia, squamous		2 (4%)	20 (41%)	20 (41%)
Goblet cell, respiratory epithelium, hyperplasia		16 (33%)	29 (59%)	20 (41%)
Olfactory epithelium, atrophy		49 (100%)	49 (100%)	47 (96%)
Olfactory epithelium, degeneration, hyaline	13 (27%)	46 (94%)	49 (100%)	45 (92%)
Olfactory epithelium, hyperplasia, atypical		48 (98%)	48 (98%)	43 (88%)
Olfactory epithelium, inflammation, chronic		47 (96%)	47 (96%)	45 (92%)
Respiratory epithelium, degeneration, hyaline	8 (16%)	33 (67%)	34 (69%)	28 (57%)
Respiratory epithelium, hyperplasia		18 (37%)	22 (45%)	23 (47%)
Respiratory epithelium, metaplasia, squamous		21 (43%)	17 (35%)	15 (31%)
Special Senses System				
Eye	(48)	(47)	(46)	(48)
Cataract	5 (10%)	2 (4%)	6 (13%)	3 (6%)
Cornea, infiltration cellular, polymorphonuclear	2 (4%)			
Retina, atrophy	5 (10%)	2 (4%)	4 (9%)	2 (4%)
Harderian gland				(1)
Inflammation, chronic				1 (100%)
Urinary System				
Kidney	(48)	(49)	(49)	(49)
Cyst		1 (2%)		
Infarct			1 (2%)	1 (2%)
Nephropathy	41 (85%)	38 (78%)	34 (69%)	31 (63%)
Renal tubule, necrosis	1 (2%)	1 (2%)		

APPENDIX C

GENETIC TOXICOLOGY

<i>SALMONELLA TYPHIMURIUM</i> MUTAGENICITY TEST PROTOCOL	126
CHINESE HAMSTER OVARY CELL CYTOGENETICS PROTOCOLS	126
EVALUATION PROTOCOL	127
RESULTS	128
TABLE C1 Mutagenicity of Naphthalene in <i>Salmonella typhimurium</i>	129
TABLE C2 Induction of Sister Chromatid Exchanges in Chinese Hamster Ovary Cells by Naphthalene	130
TABLE C3 Induction of Chromosomal Aberrations in Chinese Hamster Ovary Cells by Naphthalene	132

GENETIC TOXICOLOGY

***SALMONELLA TYPHIMURIUM* MUTAGENICITY TEST PROTOCOL**

Testing was performed as reported by Mortelmans *et al.* (1986). Naphthalene was sent to the laboratory as a coded aliquot from Radian Corporation (Austin, TX). It was incubated with the *Salmonella typhimurium* tester strains TA98, TA100, TA1535, and TA1537 either in buffer or S9 mix (metabolic activation enzymes and cofactors from Aroclor 1254-induced male Sprague-Dawley rat or Syrian hamster liver) for 20 minutes at 37° C. Top agar supplemented with L-histidine and d-biotin was added, and the contents of the tubes were mixed and poured onto the surfaces of minimal glucose agar plates. Histidine-independent mutant colonies arising on these plates were counted following incubation for 2 days at 37° C.

Each trial consisted of triplicate plates of concurrent positive and negative controls and five doses of naphthalene. The high dose was limited by toxicity. All trials were repeated.

In this assay, a positive response is defined as a reproducible, dose-related increase in histidine-independent (revertant) colonies in any one strain/activation combination. An equivocal response is defined as an increase in revertants that is not dose related, is not reproducible, or is not of sufficient magnitude to support a determination of mutagenicity. A negative response is obtained when no increase in revertant colonies is observed following chemical treatment. There is no minimum percentage or fold increase required for a chemical to be judged positive or weakly positive.

CHINESE HAMSTER OVARY CELL CYTOGENETICS PROTOCOLS

Testing was performed as reported by Galloway *et al.* (1987). Naphthalene was sent to the laboratory as a coded aliquot by Radian Corporation. It was tested in cultured Chinese hamster ovary (CHO) cells for induction of sister chromatid exchanges (SCEs) and chromosomal aberrations (Abs), both in the presence and absence of Aroclor 1254-induced male Sprague-Dawley rat liver S9 and cofactor mix. Cultures were handled under gold lights to prevent photolysis of bromodeoxyuridine-substituted DNA. Each test consisted of concurrent solvent and positive controls and of at least three doses of naphthalene. The high dose was limited by toxicity. A single flask per dose was used, and all tests were repeated.

Sister Chromatid Exchange Test: In the SCE test without S9, CHO cells were incubated for 25.8 hours with naphthalene in supplemented McCoy's 5A medium. Bromodeoxyuridine (BrdU) was added 2 hours after culture initiation. After 25.8 hours, the medium containing naphthalene was removed and replaced with fresh medium plus BrdU and Colcemid, and incubation was continued for 2 hours. Cells were then harvested by mitotic shake-off, fixed, and stained with Hoechst 33258 and Giemsa. In the SCE test with S9, cells were incubated with naphthalene, serum-free medium, and S9 for 2 hours. The medium was then removed and replaced with medium containing serum and BrdU and no naphthalene. Incubation proceeded for an additional 25.8 hours, with Colcemid present for the final 2 hours. Harvesting and staining were the same as for cells treated without S9. All slides were scored blind, and those from a single test were read by the same person. Fifty second-division metaphase cells were scored for frequency of SCEs/cell at each dose. Due to the high frequencies of SCEs seen, only 25 cells were scored in the repeat trials under each activation condition. Because significant chemical-induced cell cycle delay was anticipated at the highest concentration of naphthalene in the initial trials with and without S9, incubation time was lengthened to ensure a sufficient number of scorable (second-division metaphase) cells.

Statistical analyses were conducted on the slopes of the dose-response curves and the individual dose points (Galloway *et al.*, 1987). An SCE frequency 20% above the concurrent solvent control value was chosen as a

statistically conservative positive response. The probability of this level of difference occurring by chance at one dose point is less than 0.01; the probability for such a chance occurrence at two dose points is less than 0.001. An increase of 20% or greater at any single dose was considered weak evidence of activity; increases at two or more doses resulted in a determination that the trial was positive. A statistically significant trend ($P < 0.005$) in the absence of any responses reaching 20% above background led to a call of equivocal.

Chromosomal Aberrations Test: In the Abs test without S9, cells were incubated in McCoy's 5A medium with naphthalene for 8.2 or 18.5 hours; Colcemid was added and incubation continued for 2 hours. The cells were then harvested by mitotic shake-off, fixed, and stained with Giemsa. For the Abs test with S9, cells were treated with naphthalene and S9 for 2 hours, after which the treatment medium was removed and the cells were incubated for approximately 18 hours in fresh medium, with Colcemid present for the final 2 hours. Cells were harvested in the same manner as for the treatment without S9. The harvest time for the Abs test was based on the cell cycle information obtained in the SCE test: the incubation period was extended in all but the second trial without S9.

Cells were selected for scoring on the basis of good morphology and completeness of karyotype (21 ± 2 chromosomes). All slides were scored blind, and those from a single test were read by the same person. Two hundred first-division metaphase cells were scored at each dose level, except in the first trial with S9, in which only 100 cells were scored at the two highest doses due to high numbers of aberrant cells. Classes of aberrations included simple (breaks and terminal deletions), complex (rearrangements and translocations), and other (pulverized cells, despiralized chromosomes, and cells containing 10 or more aberrations).

Chromosomal aberration data are presented as percentages of cells with aberrations. To arrive at a statistical call for a trial, analyses were conducted on both the dose response curve and individual dose points. For a single trial, a statistically significant ($P \leq 0.05$) difference for one dose point and a significant trend ($P \leq 0.015$) were considered weak evidence for a positive response; significant differences for two or more doses indicated the trial was positive. A positive trend test in the absence of a statistically significant increase at any one dose resulted in an equivocal call (Galloway *et al.*, 1987). Ultimately, the trial calls were based on a consideration of the statistical analyses as well as the biological information available to the reviewers.

EVALUATION PROTOCOL

These are the basic guidelines for arriving at an overall assay result for assays performed by the National Toxicology Program. Statistical as well as biological factors are considered. For an individual assay, the statistical procedures for data analysis have been described in the preceding protocols. There have been instances, however, in which multiple aliquots of a chemical were tested in the same assay, and differing results were obtained among aliquots and/or among laboratories. Results from more than one aliquot or from more than one laboratory are not simply combined into an overall result. Rather, all the data are critically evaluated, particularly with regard to pertinent protocol variations, in determining the weight of evidence for an overall conclusion of chemical activity in an assay. In addition to multiple aliquots, the *in vitro* assays have another variable that must be considered in arriving at an overall test result. *In vitro* assays are conducted with and without exogenous metabolic activation. Results obtained in the absence of activation are not combined with results obtained in the presence of activation; each testing condition is evaluated separately. The summary table in the Abstract of this Technical Report presents a result that represents a scientific judgement of the overall evidence for activity of the chemical in an assay.

RESULTS

Naphthalene (0.3 to 100 µg/plate) was not mutagenic in *S. typhimurium* strains TA98, TA100, TA1535, or TA1537, with or without induced rat or hamster liver S9 activation enzymes (Table C1; Mortelmans *et al.*, 1986). In contrast to these negative results for gene mutation induction in bacteria, naphthalene was positive for induction of chromosomal effects in mammalian cells *in vitro*. In cultured CHO cells, naphthalene induced dose-related increases in SCEs, with and without rat liver S9 activation enzymes (Table C2). In addition, Abs were induced by naphthalene in CHO cells (Table C3). A strong dose-related increase in the percent aberrant cells was observed over a concentration range of 30 to 67.5 µg/mL naphthalene in the presence of S9, but no significant increases in Abs were seen without S9.

TABLE C1
Mutagenicity of Naphthalene in *Salmonella typhimurium*^a

Strain	Dose (µg/plate)	Revertants/Plate ^b					
		-S9		+10% hamster S9		+10% rat S9	
		Trial 1	Trial 2	Trial 1	Trial 2	Trial 1	Trial 2
TA100	0.0	143 ± 4.5	141 ± 4.2	143 ± 11.9	128 ± 6.2	144 ± 2.4	137 ± 8.2
	0.3		121 ± 3.5				
	1.0	146 ± 5.8	124 ± 3.6	143 ± 13.2	115 ± 7.9	130 ± 2.7	143 ± 16.0
	3.3	124 ± 12.0	117 ± 8.5	155 ± 4.9	135 ± 2.4	133 ± 13.2	133 ± 5.9
	10.0	145 ± 5.8	113 ± 6.2	140 ± 3.5	118 ± 9.8	135 ± 8.7	121 ± 6.6
	33.0	141 ± 9.4 ^c	113 ± 5.1	147 ± 5.7	133 ± 6.8	142 ± 6.6	121 ± 7.3
	100.0	Toxic		141 ± 2.0 ^c	145 ± 9.0 ^c	104 ± 0.6 ^c	127 ± 5.4 ^c
Trial summary		Negative	Negative	Negative	Negative	Negative	Negative
Positive control ^d		1,636 ± 45.5	801 ± 28.7	2,534 ± 77.9	754 ± 19.2	1,074 ± 13.2	792 ± 26.4
TA1535	0.0	22 ± 1.5	19 ± 2.6	11 ± 2.3	8 ± 0.6	9 ± 0.6	12 ± 2.4
	0.3		24 ± 3.1				
	1.0	21 ± 3.0	26 ± 2.7	10 ± 3.3	11 ± 2.9	13 ± 1.2	16 ± 1.5
	3.3	22 ± 5.2	23 ± 2.3	10 ± 0.9	11 ± 3.8	9 ± 0.7	10 ± 1.7
	10.0	30 ± 2.6 ^c	20 ± 1.2	12 ± 0.6	11 ± 0.3	8 ± 0.7	10 ± 2.6
	33.0	20 ± 1.2 ^c	15 ± 2.3	13 ± 1.0	11 ± 1.7	11 ± 1.5	13 ± 1.2
	100.0	15 ± 3.5 ^c		6 ± 1.9 ^c	10 ± 3.2 ^c	13 ± 3.4 ^c	11 ± 2.9 ^c
Trial summary		Negative	Negative	Negative	Negative	Negative	Negative
Positive control		1,258 ± 18.8	687 ± 6.4	126 ± 1.7	75 ± 8.9	63 ± 8.0	48 ± 1.9
TA1537	0.0	8 ± 1.8	8 ± 1.9	10 ± 1.2	6 ± 2.4	11 ± 3.8	10 ± 2.3
	0.3		7 ± 1.2				
	1.0	8 ± 0.6	5 ± 0.6	11 ± 1.2	8 ± 0.3	10 ± 0.9	8 ± 0.7
	3.3	7 ± 1.5	9 ± 0.6	9 ± 3.2	7 ± 0.9	9 ± 0.9	9 ± 0.9
	10.0	8 ± 0.7	9 ± 1.5	12 ± 2.0	10 ± 1.5	8 ± 1.7	5 ± 2.2
	33.0	6 ± 2.0 ^c	4 ± 0.9	12 ± 1.5	10 ± 1.5	10 ± 1.9	7 ± 1.5
	100.0	Toxic		10 ± 1.0 ^c	5 ± 0.6 ^c	5 ± 1.9 ^c	4 ± 0.6 ^c
Trial summary		Negative	Negative	Negative	Negative	Negative	Negative
Positive control		1,010 ± 39.4	185 ± 12.0	205 ± 22.1	77 ± 5.3	87 ± 5.2	86 ± 2.9
TA98	0.0	14 ± 3.8	17 ± 1.0	35 ± 4.8	20 ± 3.1	29 ± 4.1	23 ± 0.3
	0.3		12 ± 2.2				
	1.0	15 ± 2.2	17 ± 1.5	30 ± 2.6	29 ± 2.1	27 ± 1.8	23 ± 2.2
	3.3	22 ± 2.3	12 ± 2.6	42 ± 5.5	21 ± 1.9	32 ± 1.7	24 ± 0.7
	10.0	16 ± 3.3	12 ± 2.6	32 ± 4.2	26 ± 1.2	25 ± 2.6	21 ± 0.9
	33.0	19 ± 2.5 ^c	12 ± 3.2	32 ± 3.1	21 ± 1.2	29 ± 1.9	24 ± 2.8
	100.0	14 ± 0.3 ^c		34 ± 1.5 ^c	23 ± 2.4	22 ± 1.2 ^c	24 ± 1.2
Trial summary		Negative	Negative	Negative	Negative	Negative	Negative
Positive control		1,772 ± 9.6	1,072 ± 40.3	2,064 ± 71.4	183 ± 10.1	982 ± 43.1	176 ± 16.6

^a Study was performed at EG&G Mason Research. The detailed protocol and these data are presented by Mortelmans *et al.* (1986). 0 µg/plate was the solvent control.

^b Revertants are presented as mean ± standard error from three plates.

^c Slight toxicity

^d The positive controls in the absence of metabolic activation were sodium azide (TA100 and TA1535), 9-aminoacridine (TA1537), and 4-nitro-*o*-phenylenediamine (TA98). The positive control for metabolic activation with all strains was 2-aminoanthracene.

TABLE C2
Induction of Sister Chromatid Exchanges in Chinese Hamster Ovary Cells by Naphthalene^a

Compound	Dose (µg/mL)	Total Cells Scored	No. of Chromo- somes	No. of SCEs	SCEs/ Chromo- some	SCEs/ Cell	Hrs in BrdU	Relative Change of SCEs/ Chromosome ^b (%)
-S9								
Trial 1								
Summary: Weakly positive								
Dimethylsulfoxide ^c		50	1,046	388	0.37	7.8	25.8	
Naphthalene	9	50	1,048	406	0.38	8.1	25.8	4.44
	27	50	1,041	442	0.42	8.8	25.8	14.47
	90	50	1,042	578	0.55	11.6	30.9 ^d	49.54*
	270	Toxic						
					P<0.001 ^e			
Mitomycin-C ^f	0.001	50	1,049	597	0.56	11.9	25.8	53.43*
	0.010	5	105	217	2.06	43.4	25.8	457.16*
Trial 2								
Summary: Positive								
Dimethylsulfoxide		25	525	178	0.33	7.1	25.8	
Naphthalene	27	25	525	222	0.42	8.9	25.8	24.72*
	45	25	525	268	0.51	10.7	25.8	50.56*
	90	25	525	268	0.51	10.7	25.8	50.56*
					P<0.001			
Mitomycin-C	0.001	25	525	376	0.71	15.0	25.8	111.24*
	0.010	5	105	263	2.50	52.6	25.8	638.78*

TABLE C2
Induction of Sister Chromatid Exchanges in Chinese Hamster Ovary Cells by Naphthalene

Compound	Dose (µg/mL)	Total Cells Scored	No. of Chromosomes	No. of SCEs	SCEs/Chromosome	SCEs/Cell	Hrs in BrdU	Relative Change of SCEs/Chromosome (%)
+S9								
Trial 1								
Summary: Equivocal								
Dimethylsulfoxide		50	1,050	423	0.40	8.5	25.8	
Naphthalene	2.7	50	1,050	411	0.39	8.2	25.8	-2.84
	9.0	50	1,050	493	0.46	9.9	25.8 ^f	16.55
	27.0	50	1,045	505	0.48	10.1	30.9 ^f	19.96
	90.0	Toxic						
P<0.001								
Cyclophosphamide ^f	0.4	50	1,050	792	0.75	15.8	25.8	87.24*
	2.0	5	105	197	1.87	39.4	25.8	365.73*
Trial 2								
Summary: Positive								
Dimethylsulfoxide		25	525	189	0.36	7.6	25.8	
Naphthalene	9	25	525	199	0.37	8.0	25.8	5.29
	15	25	525	239	0.45	9.6	25.8	26.45*
	27	25	525	266	0.50	10.6	25.8	40.74*
	45	Toxic						
P<0.001								
Cyclophosphamide	0.4	25	525	334	0.63	13.4	25.8	76.72*
	2.0	5	105	174	1.65	34.8	25.8	360.32*

* Positive response (≥20% increase over solvent control)

^a Study was performed at Litton Bionetics, Inc. The detailed protocol is presented by Galloway *et al.* (1987). SCE=sister chromatid exchange; BrdU=bromodeoxyuridine

^b SCEs/chromosome in treated cells versus SCEs/chromosome in solvent control cells

^c Solvent control

^d Due to cell cycle delay, harvest time was extended to maximize the number of second-division metaphase cells available for analysis.

^e Significance tested by the linear regression trend test versus log of the dose

^f Positive control

TABLE C3
Induction of Chromosomal Aberrations in Chinese Hamster Ovary Cells by Naphthalene^a

Compound	Dose (µg/mL)	Total Cells Scored	Number of Aberrations	Aberrations/Cell	Cells with Aberrations (%)
-S9					
Trial 1					
Harvest time: 20.5 hours					
Summary: Negative					
Dimethylsulfoxide ^b		200	1	0.01	0.5
Naphthalene	37.5	200	2	0.01	1.0
	75.0	200	3	0.02	1.5
	112.5	Toxic			
					P=0.157 ^c
Mitomycin-C ^d	0.05	200	31	0.16	11.0*
	0.08	25	25	1.00	48.0*
Trial 2					
Harvest time: 10.2 hours					
Summary: Negative					
Dimethylsulfoxide		200	1	0.01	0.5
Naphthalene	15.0	200	2	0.01	0.5
	37.5	200	0	0.00	0.0
					P=0.807
Mitomycin-C	0.25	200	19	0.10	8.5*
	0.75	25	6	0.24	24.0*

TABLE C3
Induction of Chromosomal Aberrations in Chinese Hamster Ovary Cells by Naphthalene

Compound	Dose (µg/mL)	Total Cells Scored	Number of Aberrations	Aberrations/ Cell	Cells with Aberrations (%)
+S9					
Trial 1					
Harvest time: 20.5 hours					
Summary: Positive					
Dimethylsulfoxide		200	3	0.02	1.5
Naphthalene	30.0	200	29	0.15	11.0*
	45.0	100	27	0.27	20.0*
	67.5	100	50	0.50	32.0*
	90.0	Toxic			
					P<0.001
Cyclophosphamide ^d	6.25	200	31	0.16	13.5*
	12.50	25	17	0.68	44.0*
Trial 2					
Harvest time: 20.2 hours					
Summary: Positive					
Dimethylsulfoxide		200	0	0.00	0.0
Naphthalene	45.00	200	29	0.15	8.5*
	56.25	200	39	0.20	13.5*
	67.50	200	37	0.19	16.0*
					P<0.001
Cyclophosphamide	6.25	200	23	0.12	11.5*
	12.50	25	19	0.76	52.0*

* Positive response ($P \leq 0.05$) versus the solvent control

^a Study was performed at Litton Bionetics, Inc. The detailed protocol is presented by Galloway *et al.* (1987).

^b Solvent control

^c Significance of percent cells with aberrations tested by the linear regression trend test versus log of the dose

^d Positive control

APPENDIX D

TOXICOKINETIC RESULTS AND MODEL

INTRODUCTION	136
MATERIALS AND METHODS	136
MODEL DEVELOPMENT	136
RESULTS	139
DISCUSSION	140
REFERENCES	141
FIGURE D1 Diffusion-Limited Pharmacokinetic Model for Rats Exposed to Naphthalene by Inhalation	143
TABLE D1 Blood Concentrations of Naphthalene in F344/N Rats after a Single 6-Hour Inhalation Exposure	144
TABLE D2 Blood Concentrations of Naphthalene in Rats at 2 Weeks and 3, 6, 12, and 18 Months in the 2-Year Inhalation Study of Naphthalene	145
TABLE D3 Blood Concentrations of Naphthalene in B6C3F ₁ Mice after a Single 6-Hour Inhalation Exposure	148
FIGURE D2 Blood Concentrations of Naphthalene (mean ± standard deviation, in µg/mL) in Male Rats after (A) a Single Exposure or (B) Exposure for 2 Weeks or 3, 6, 12, or 18 Months to Naphthalene by Inhalation	149
FIGURE D3 Blood Concentrations of Naphthalene (mean ± standard deviation, in µg/mL) in Female Rats after (A) a Single Exposure or (B) Exposure for 2 Weeks or 3, 6, 12, or 18 Months to Naphthalene by Inhalation	149
FIGURE D4 Blood Concentrations of Naphthalene (mean ± standard deviation, in µg/mL) in Male and Female Mice after a Single Exposure to Naphthalene by Inhalation	150
TABLE D4 Cardiac Output, Organ Volumes, Organ Blood Perfusion Rates, and Optimized Metabolic Parameters of Rats and Mice for the Physiologically Based Pharmacokinetic Model of Naphthalene	151
TABLE D5 Model-Based Estimates of Naphthalene Concentration and Metabolism in the Liver and Lung of Rats	152
TABLE D6 Model-Based Estimates of Naphthalene Concentration and Metabolism in the Liver and Lung of Mice	153

TOXICOKINETIC RESULTS AND MODEL

INTRODUCTION

A physiologically based pharmacokinetic model representing the uptake, distribution, and metabolism of naphthalene in rats and mice was developed to describe the processes involved in naphthalene toxicokinetics. Blood time-course data of the parent compound following inhalation exposure were available to model the distribution of naphthalene throughout the body and to estimate metabolic rates in the lung and liver. No information was available on the rate of production or distribution of the metabolites or on the excretion of the parent compound or its metabolites.

MATERIALS AND METHODS

Whole blood samples from groups of nine male and nine female toxicokinetic study rats from the 2-year study, which were administered 10, 30, or 60 ppm naphthalene by inhalation, were analyzed for naphthalene concentrations at 2 weeks and 3, 6, 12, and 18 months. Additional groups of 12 male and 12 female rats and mice were obtained from the same suppliers used in the 2-year study; rats were evaluated after a single 6-hour inhalation exposure to 10, 30, or 60 ppm naphthalene, and mice were evaluated after a single 6-hour exposure to 10 or 30 ppm. Blood was taken at eight (single-exposure groups) or 10 (toxicokinetic study groups) time points postexposure per collection period; each group of toxicokinetic study rats was evaluated at 6 of the 10 time points. Each animal was bled twice. At each time point, blood was taken from up to three animals per group, and naphthalene concentrations in whole blood were measured. The samples were analyzed by CEDRA Corporation (Austin, TX) using a previously validated high-performance liquid chromatography method with ultraviolet light detection (CEDRA, 1994).

MODEL DEVELOPMENT

The model, which is diffusion limited (Kohn, 1997), contains compartments for arterial and venous blood, alveolar space, and tissue and capillary spaces for the lung, liver, kidney, fat, and other organs (Figure D1). The compartment for other organs represents both slowly and rapidly perfused tissues (e.g., skin, muscle, bone, heart, and brain). Inhalation of naphthalene from chamber air takes place through the alveolar space into the lung. Uptake is modeled as being dependent on the ventilation rate of the animal, permeability of the tissue, and blood flow through the lung. The primary sites for naphthalene metabolism were assumed to be the lung and the liver. In the lung, one metabolic pathway was used, while in the liver, two pathways were taken into account, one represented by Michaelis-Menten kinetics and the other by Hill kinetics. The same K_m was used in the lung and the Michaelis-Menten pathway in the liver, but different values were estimated for V_{max} in all three pathways. The other compartments were included due to their role in distribution kinetics. All the physiological parameters (ventilation rate, cardiac output, tissue volumes, capillary volumes, and blood flow rates to the tissues) used in this model were based on values obtained from the literature and scaled to the body weights of the 2-year core study rats. Partition coefficients for the different tissues were calculated from the log octanol:water partition coefficient (K_{ow}) using methods developed by Fiserova-Bergerova *et al.* (1984), Abraham *et al.* (1985), and Lyman *et al.* (1990) and are the same for male and female rats ($P_{blood:air}=571$, $P_{lung:blood}=1.81$, $P_{liver:blood}=7.0$, $P_{fat:blood}=160.4$, $P_{kidney:blood}=4$ and $P_{other:blood}=4$).

Metabolic rates and permeability constants were estimated by optimizing the model to the available naphthalene blood time-course data. Goodness of fit was evaluated using a maximum-likelihood ratio test (Kotz and Johnson, 1983). The program package MATLAB (The MathWorks, Inc., Natick, MA), including Simulink, was used for simulation and optimization of the model.

The physiologically based pharmacokinetic model consists of the ordinary differential equations presented below. In this model, naphthalene is taken up from the exposure chamber atmosphere via the alveolar space into the lung capillary blood (Equations 0.1 and 0.2). From the lung capillary blood, it can enter the arterial blood (Equation 0.3) and distribute to the other tissues or go into the lung tissue and subsequently undergo metabolism (Equations 0.4 and 0.5). The effluent from all of the tissue capillary spaces except the lung capillary space goes to the venous blood compartment and is then redirected to the lung capillary space (Equation 0.6). The liver is the only tissue other than the lung in which metabolism was assumed to take place (Equations 0.7 and 0.8). All other nonmetabolizing tissues (fat, kidney, and other) are represented by Equations 0.9 and 0.10.

Differential Equations

Chamber:

$$\frac{dAMT_{air}}{dt} = Dose - Dose \cdot Q_{vent} \quad (0.1)$$

Alveolar space:

$$\begin{aligned} \frac{dAMT_{alv}}{dt} = & Dose \cdot Q_{vent} + \frac{AMT_{lungcap}}{V_{lungcap}} \cdot \frac{Q_{vent}}{P_{air}} \cdot Perm - \dots \\ & \frac{AMT_{alv}}{V_{alv}} \cdot Q_{vent} \cdot Perm - \frac{AMT_{alv}}{V_{alv}} \cdot Q_{vent} \end{aligned} \quad (0.2)$$

Arterial blood:

$$\frac{dAMT_{art}}{dt} = \frac{AMT_{lungcap}}{V_{lungcap}} \cdot Q_{total} - \frac{AMT_{art}}{V_{art}} \cdot Q_{total} \quad (0.3)$$

Lung:

$$\begin{aligned} \frac{dAMT_{lungcap}}{dt} = & \frac{AMT_{ven}}{V_{ven}} \cdot Q_{total} + \frac{AMT_{alv}}{V_{alv}} \cdot Q_{vent} \cdot Perm + \dots \\ & \frac{AMT_{lung}}{V_{lung}} \cdot \frac{Q_{total}}{P_{lung}} \cdot Perm - \frac{AMT_{lungcap}}{V_{lungcap}} \cdot Q_{total} - \dots \\ & \frac{AMT_{lungcap}}{V_{lungcap}} \cdot Q_{total} \cdot Perm - \frac{AMT_{lungcap}}{V_{lungcap}} \cdot \frac{Q_{vent}}{P_{air}} \cdot Perm \end{aligned} \quad (0.4)$$

$$\frac{dAMT_{lung}}{dt} = \frac{AMT_{lungcap}}{V_{lungcap}} \cdot Q_{total} \cdot Perm - \frac{AMT_{lung}}{V_{lung}} \cdot \frac{Q_{total}}{P_{lung}} \cdot Perm - \dots$$

$$\frac{V_{maxlung} \cdot V_{lung} \cdot AMT_{lung}}{K_{mlung} \cdot V_{lung} + AMT_{lung}} \quad (0.5)$$

Venous blood:

$$\frac{dAMT_{ven}}{dt} = \sum \frac{AMT_{tissuecap}}{V_{tissuecap}} \cdot Q_{tissue} - \frac{AMT_{ven}}{V_{ven}} \cdot Q_{total} \quad (0.6)$$

Liver:

$$\frac{dAMT_{livercap}}{dt} = \frac{AMT_{art}}{V_{art}} \cdot Q_{liver} + \frac{AMT_{liver}}{V_{liver}} \cdot \frac{Q_{liver}}{P_{liver}} \cdot Perm - \dots$$

$$\frac{AMT_{livercap}}{V_{livercap}} \cdot Q_{liver} - \frac{AMT_{livercap}}{V_{livercap}} \cdot Q_{liver} \cdot Perm \quad (0.7)$$

$$\frac{dAMT_{liver}}{dt} = \frac{AMT_{livercap}}{V_{livercap}} \cdot Q_{liver} \cdot Perm - \frac{AMT_{liver}}{V_{liver}} \cdot \frac{Q_{liver}}{P_{liver}} \cdot Perm - \dots$$

$$\frac{V_{maxliver1} \cdot V_{liver} \cdot AMT_{liver}}{K_{mliver1} \cdot V_{liver} + AMT_{liver}} - \frac{V_{maxliver2} \cdot V_{liver} \cdot AMT_{liver}^n}{(K_{mliver2} \cdot V_{liver})^n + AMT_{liver}^n} \quad (0.8)$$

Fat, kidney, and other nonmetabolizing tissues:

$$\frac{dAMT_{tissuecap}}{dt} = \frac{AMT_{art}}{V_{art}} \cdot Q_{tissue} + \frac{AMT_{tissue}}{V_{tissue}} \cdot \frac{Q_{tissue}}{P_{tissue}} \cdot Perm - \dots$$

$$\frac{AMT_{tissuecap}}{V_{tissuecap}} \cdot Q_{tissue} - \frac{AMT_{tissuecap}}{V_{tissuecap}} \cdot Q_{tissue} \cdot Perm \quad (0.9)$$

$$\frac{dAMT_{tissue}}{dt} = \frac{AMT_{tissuecap}}{V_{tissuecap}} \cdot Q_{tissue} \cdot Perm - \frac{AMT_{tissue}}{V_{tissue}} \cdot \frac{Q_{tissue}}{P_{tissue}} \cdot Perm \quad (0.10)$$

Definitions of Abbreviations

V volume of tissue or blood (mL)

Concentrations:

$Dose$ chamber concentration of naphthalene (ppm)

AMT_{air} amount in the air (mg)

AMT_{alv} amount in the alveolar space (mg)

AMT_{art} amount in the arterial blood (mg)

AMT_{ven} amount in the venous blood (mg)

$AMT_{tissuecap}$ amount in the tissue capillary blood (mg)

AMT_{tissue} amount in the tissue (mg)

Flows:

Q_{vent} ventilation rate (mL/min)

Q_{total} total blood flow (mL/min)

Q_{tissue} blood flow to the tissue (mL/min)

Partition coefficients and permeability constant:

$Perm$ capillary permeability constant

P_{tissue} tissue:blood partition coefficient

P_{air} blood:air partition coefficient

Metabolism rates:

V_{max} maximum velocity of saturable metabolism (nmol/mL per minute)

K_m Michaelis-Menten constant for metabolism (nmol/mL)

n Hill constant

RESULTS

The model is shown in Figure D1. The blood time-course data for rats are given in Tables D1 and D2; the blood time-course data for mice are given in Table D3. A graphic representation of these data and the fits of the model are shown in Figures D2 and D3 for male and female rats and Figure D4 for mice. The physiological parameters for the model are given in Table D4. Estimates of naphthalene concentrations and metabolism in the lung and liver are given in Tables D5 and D6 for rats and mice, respectively.

This model was the best-fitting product after testing several alternative models. Sweeney *et al.* (1996) and Quick and Shuler (1999) developed models for naphthalene and naphthalene oxide metabolism in rats and mice in which they presented two Michaelis-Menten based metabolic pathways in both the lung and the liver. In the model described in this report, the metabolism of naphthalene oxide was not included, as there were no data available on the blood concentrations of the two different naphthalene metabolites, 1-(R)-2-(S)- and 1-(S)-2-(R)-naphthalene oxide. In an initial model, only one metabolic pathway for naphthalene metabolism in both the lung and liver was applied, as the use of two metabolic pathways did not improve the fit. Using this single metabolic pathway model resulted in an underprediction of the blood concentrations for the first 60 to 90 minutes postexposure, and the predicted maximum concentration in the blood at the end of the exposure period was not great enough to match the experimental data. Several attempts were made to eliminate this problem (e.g., modeling competitive inhibition of the P450 enzymes, noncompetitive inhibition, and suicidal inhibition) without any improvement in fit, as indicated by the likelihood test. However, introducing a second metabolic pathway in the liver, in the form of a Hill equation, greatly improved the fit to the data even though there is still an underprediction of the first time point at the highest exposure concentration. Graphic

representations of the fits of the model are shown in Figures D2 and D3 for male and female rat data, respectively, and in Figure D4 for mouse data. The predictions of the model for 2 weeks and 3, 6, 12, and 18 months were the same; therefore, data from these exposure durations were combined and presented as single figures for male and female rats. The single-exposure data for rats and mice are presented separately.

DISCUSSION

After a rapid uptake of naphthalene into the blood ($P_{blood:air}=571$), male and female rats appear to have an equal capacity for metabolism in the lungs, as do male and female mice. However, saturation of the metabolism occurs at lower naphthalene blood concentrations in female mice than in male mice. Similarly, the liver metabolic pathway represented by the Michaelis-Menten equation shows the same metabolic capacity and saturation level in male and female rats. Both the metabolic capacity and saturation level are lower in female mice than in male mice. The second liver metabolic pathway, characterized by a Hill equation with a Hill exponent of 2, shows a similar metabolic capacity and saturation level in male and female rats. In mice, the metabolic capacity is the same for males and females, but the saturation level is lower in females. The permeability of fat is less than that of the other tissues. Permeabilities are approximately similar between male and female rats. The permeability of fat in female mice is lower than that in males. Based on the available blood time-course data for naphthalene alone, no conclusions can be reached on which metabolites may be responsible for naphthalene toxicity.

Even though data are available from a single-dose intravenous injection study (NTP, unpublished), these were not included in the modeling effort in this report. The model outcomes from the inhalation and intravenous injection studies show a discrepancy. To be able to get a reasonable fit for the intravenous injection data, the parameters for the permeability of the fat and other tissues need to be much higher than those observed in the inhalation study. Why this occurred cannot be explained at this time. Nevertheless, as exposure to naphthalene through inhalation was the route of exposure used in the chronic study, and more data are therefore available for the inhalation route, the model developed from these data has been given preference. Secondly, there is also a large spread in the intravenous injection data, possibly attributable to errors in administering the dose into the tail vein of the animals, and these data should be interpreted with caution when used for modeling purposes.

The model developed to characterize the disposition of inhaled naphthalene in rats and mice was used to estimate the following parameters: a) the amounts of naphthalene inhaled by rats and mice (NTP, 1992) at the exposure concentrations used in the 2-year studies of this chemical, b) the amount of the inhaled dose that was metabolized during the 6-hour (rat) or 6-hour (mouse) exposure and during the 18 hours following exposure, c) the steady-state concentrations of naphthalene in the liver and lung of rats and mice during exposure, and d) the rate of naphthalene metabolism in the liver and lung of rats and mice at these steady-state concentrations. Approximately 22% to 31% of inhaled naphthalene is metabolized by rats and 65% to 73% of inhaled naphthalene is metabolized by mice. These values for the percentage of the inhaled parent compound that is metabolized are greater than those reported for volatile chemicals (Richardson *et al.*, 1999) and probably reflect the low vapor pressure of naphthalene and its very high estimated blood-to-air partition coefficient. Thus, once naphthalene is absorbed into the general circulation, very little parent compound is eliminated by exhalation. Because essentially all of the naphthalene that is absorbed is metabolized, the values for total naphthalene metabolized (presented in mg/kg body weight in Tables D5 and D6) represent the internalized dose of naphthalene in rats and mice resulting from 6-hour exposures, respectively. The species difference in the absorption of inhaled naphthalene probably reflects the greater metabolic capacity of mice compared to rats. Increased metabolism will tend to increase the gradient in concentration of naphthalene in the alveolar space compared to the lung blood and thus enhance further absorption of the compound. Total naphthalene metabolized (i.e., the internalized dose) was nearly equivalent for mice exposed to 10 ppm and

rats exposed to 60 ppm. This difference is due to the higher ventilation rates and greater metabolism of naphthalene in mice compared to rats.

These data also show that the steady-state concentration of naphthalene in the lung of rats is not very different from that of mice exposed to equivalent concentrations. For example, after 6 hours of exposure to 30 ppm, the concentration of parent compound was 1.8 µg/mL in rats and 2.6 to 2.8 µg/mL in mice. Rats exposed to 60 ppm naphthalene had higher concentrations of naphthalene in the lung (5.3 µg/mL) than did mice exposed to 30 ppm. Rates of metabolism and the cumulative metabolism of naphthalene in the lung were markedly greater in mice than in rats. Rates of naphthalene metabolism did not increase proportionally with increasing exposure concentration, indicating metabolic saturation in this organ. Metabolic saturation was more evident in the rat lung than in the mouse lung. Naphthalene metabolism was also greater in the mouse liver than in the rat liver; however, the species difference in liver metabolism was not as marked as that in the lung. Metabolic saturation was only apparent in the liver of rats exposed to 60 ppm. For both species, 65% to 75% of the metabolic clearance occurred during the 6-hour exposure periods; only in the 60 ppm rats was metabolic clearance at about 50% of the total inhaled dose. This is probably due to metabolic saturation resulting in greater storage of parent compound in the fat at this exposure concentration.

REFERENCES

- Abraham, M.H., Kamlet, M.J., Taft, R.W., Doherty, R.M., and Weathersby, P.K. (1985). Solubility properties in polymers and biological media. 2. The correlation and prediction of the solubilities of nonelectrolytes in biological tissues and fluids. *J. Med. Chem.* **28**, 865-870.
- Altman, P.L., and Dittmer, D.S., Eds. (1971). *Respiration and Circulation*. Federation of American Societies for Experimental Biology, Bethesda, MD.
- Brown, R.P., Delp, M.D., Lindstedt, S.L., Rhomberg, L.R., and Beliles, R.P. (1997). Physiological parameter values for physiologically based pharmacokinetic models. *Toxicol. Ind. Health* **13**, 407-484.
- CEDRA Corporation (1994). Biological Sample Method Development Report for Naphthalene in Rodent Blood. DCN No. A92-21-04/278.
- Davies, B., and Morris, T. (1993). Physiological parameters in laboratory animals and humans. *Pharm. Res.* **10**, 1093-1095.
- Fiserova-Bergerova, V., Tichy, M., and Di Carlo, F.J. (1984). Effects of biosolubility on pulmonary uptake and disposition of gases and vapors of lipophilic chemicals. *Drug Metab. Rev.* **15**, 1033-1070.
- Kohn, M.C. (1997). The importance of anatomical realism for validation of physiological models of disposition of inhaled toxicants. *Toxicol. Appl. Pharmacol.* **147**, 448-458.
- Kotz, S., and Johnson, N.L., Eds. (1983). *Encyclopedia of Statistical Sciences*, Vol. 5. John Wiley and Sons, New York.
- Lyman, W.J., et al. (1990). *Handbook of Chemical Property Estimation Methods*. American Chemical Society, Washington, DC.

National Toxicology Program (NTP) (1992). Toxicology and Carcinogenesis Studies of Naphthalene (CAS No. 91-20-3) in B6C3F₁ Mice (Inhalation Studies). Technical Report Series No. 410. NIH Publication No. 92-3141. U.S. Department of Health and Human Services, Public Health Service, National Institutes of Health, Research Triangle Park, NC.

Quick, D.J., and Shuler, M.L. (1999). Use of in vitro data for construction of a physiologically based pharmacokinetic model for naphthalene in rats and mice to probe species differences. *Biotechnol. Prog.* **15**, 540-555.

Richardson, K.A., Peters, M.M., Wong, B.A., Megens, R.H., van Elburg, P.A., Booth, E.D., Boogaard, P.J., Bond, J.A., Medinsky, M.A., Watson, W.P., and van Sittert, N.J. (1999). Quantitative and qualitative differences in the metabolism of ¹⁴C-1,3-butadiene in rats and mice: Relevance to cancer susceptibility. *Toxicol. Sci.* **49**, 186-201.

Schmidt-Nielsen, K. (1979). *Animal Physiology: Adaptation and Environment*, 2nd ed. Cambridge University Press, Cambridge.

Sweeney, L.M., Shuler, M.L., Quick, D.J., and Babish, J.G. (1996). A preliminary physiologically based pharmacokinetic model for naphthalene and naphthalene oxide in mice and rats. *Ann. Biomed. Eng.* **24**, 305-320.

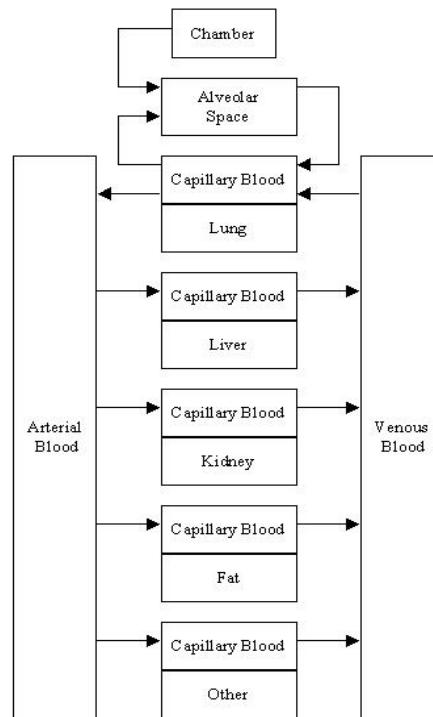

FIGURE D1
Diffusion-Limited Pharmacokinetic Model for Rats Exposed to Naphthalene by Inhalation

TABLE D1
Blood Concentrations of Naphthalene in F344/N Rats after a Single 6-Hour Inhalation Exposure^a

Time after Exposure (minutes)	10 ppm	30 ppm	60 ppm
n	3	3	3
Male			
0	0.463 ± 0.034	1.387 ± 0.052	5.360 ± 0.666
30	0.308 ± 0.009	0.911 ± 0.051	3.193 ± 0.336
60	0.171 ± 0.008	0.661 ± 0.059	2.227 ± 0.388
90	0.094 ± 0.009	0.476 ± 0.018	1.143 ± 0.256
120	0.100 ± 0.011	0.239 ± 0.028	0.838 ± 0.149
240	0.051 ± 0.002	0.138 ± 0.007	0.380 ± 0.042
360	0.029 ± 0.001	0.071 ± 0.001	0.252 ± 0.009
480	0.014 ± 0.003	0.060 ± 0.003	0.174 ± 0.023
Female			
0	0.442 ± 0.029	1.667 ± 0.157	4.850 ± 0.112
30	0.243 ± 0.007	0.841 ± 0.086	2.483 ± 0.142
60	0.135 ± 0.008	0.632 ± 0.065	1.610 ± 0.286
90	0.087 ± 0.014	0.397 ± 0.046	0.870 ± 0.158
120	0.101 ± 0.014	0.408 ± 0.031	0.868 ± 0.072
240	0.050 ± 0.007	0.182 ± 0.016	0.428 ± 0.078
360	0.034 ± 0.005	0.100 ± 0.019	0.312 ± 0.020
480	0.016 ± 0.006	0.069 ± 0.009	0.192 ± 0.027

^a Data are given in µg/mL as the mean ± standard error.

TABLE D2
Blood Concentrations of Naphthalene in Rats at 2 Weeks and 3, 6, 12, and 18 Months
in the 2-Year Inhalation Study of Naphthalene^a

Time after Exposure (minutes)	10 ppm	30 ppm	60 ppm
n	3	3	3
Male			
Week 2			
0	0.331 ± 0.032 ^b	1.540 ± 0.067	3.730 ± 0.205 ^b
30	0.192 ± 0.015	0.765 ± 0.041	1.640 ± 0.050 ^b
60	0.118 ± 0.007		
90		0.210 ± 0.020	0.544 ± 0.056
120	0.045 ^c		
300	0.015 ± 0.004	0.047 ± 0.004	
360			0.069 ± 0.003
480	0.006 ± 0.000 ^b	0.020 ± 0.004	
720		0.007 ^c	0.022 ± 0.003 ^b
960			0.008 ± 0.002 ^b
Month 3			
0	0.424 ^c	1.483 ± 0.145	3.707 ± 0.416
30	0.309 ± 0.020	1.130 ± 0.046	2.010 ± 0.100
60	0.164 ± 0.009		
90		0.448 ± 0.013	0.905 ± 0.033
120	0.116 ^c		
300	0.029 ± 0.003	0.078 ± 0.013	
360			0.160 ± 0.012
480	0.011 ± 0.003	0.047 ± 0.003	
720		0.025 ± 0.002	0.054 ± 0.005
960			0.034 ± 0.006
Month 6			
0	0.363 ^c	1.490 ± 0.160	3.233 ± 0.147 ^b
30	0.231 ± 0.011	0.816 ± 0.024	1.980 ± 0.080 ^b
60	0.164 ± 0.008		
90		0.481 ± 0.035	1.008 ± 0.031
120	0.117 ^c		
300	0.029 ± 0.005	0.094 ± 0.004	
360			0.183 ± 0.028
480	0.011 ± 0.003	0.050 ± 0.004	
720		0.037 ± 0.002	0.075 ± 0.001 ^b
960			0.034 ± 0.003
Month 12			
0	0.522 ^c	1.523 ± 0.137	3.153 ± 0.173 ^b
30	0.363 ± 0.021	1.064 ± 0.071	2.650 ± 0.240 ^b
60	0.269 ± 0.016		
90		0.884 ± 0.014	1.473 ± 0.217
120	0.157 ^c		
300	0.054 ± 0.002	0.174 ± 0.016	
360			0.350 ± 0.012
480	0.023 ± 0.004	0.084 ± 0.010	
720		0.055 ± 0.006	0.122 ± 0.002 ^b
960			0.072 ± 0.017

TABLE D2
Blood Concentrations of Naphthalene in Rats at 2 Weeks and 3, 6, 12, and 18 Months
in the 2-Year Inhalation Study of Naphthalene

Time after Exposure (minutes)	10 ppm	30 ppm	60 ppm
n	3	3	3
Male (continued)			
Month 18			
0	0.423 ± 0.030	1.327 ± 0.037	2.893 ± 0.066
30	0.273 ± 0.018	0.987 ± 0.028	1.940 ± 0.071
60	0.268 ± 0.005		
90		0.773 ± 0.029	1.607 ± 0.174
120	0.206 ± 0.015		
300	0.074 ± 0.009	0.262 ± 0.023	
360			0.479 ± 0.083
480	0.044 ± 0.002	0.134 ± 0.012	
720		0.084 ± 0.011	0.125 ± 0.024
960			0.108 ± 0.019
Female			
Week 2			
0	0.241 ± 0.013	1.137 ± 0.022	2.910 ± 0.040 ^b
30	0.130 ± 0.024	0.606 ± 0.011	1.193 ± 0.127
60	0.102 ± 0.002		
90		0.200 ± 0.027	0.515 ± 0.010
120	0.043 ± 0.002		
300	0.010 ± 0.001	0.049 ± 0.003	
360			0.087 ± 0.017
480	0.026 ^c	0.016 ± 0.002	
720		0.008 ^c	0.006 ± 0.001 ^b
960			0.011 ^c
Month 3			
0	0.323 ± 0.021	1.261 ± 0.135	3.717 ± 0.619
30	0.197 ± 0.018	0.868 ± 0.003	1.413 ± 0.115
60	0.115 ± 0.009		
90		0.335 ± 0.028	0.623 ± 0.018
120	0.081 ± 0.008 ^b		
300	0.015 ± 0.001 ^b	0.071 ± 0.004	
360			0.176 ± 0.028
480	0.009 ± 0.001 ^b	0.045 ± 0.005	
720		0.019 ± 0.003	0.034 ± 0.001
960			0.024 ± 0.002

TABLE D2
Blood Concentrations of Naphthalene in Rats at 2 Weeks and 3, 6, 12, and 18 Months
in the 2-Year Inhalation Study of Naphthalene

Time after Exposure (minutes)	10 ppm	30 ppm	60 ppm
n	3	3	3
Female (continued)			
Month 6			
0	0.326 ± 0.040 ^b	1.437 ± 0.232	3.243 ± 0.217
30	0.181 ± 0.001 ^b	0.559 ± 0.064	1.383 ± 0.020
60	0.114 ± 0.006		
90		0.362 ± 0.016	0.667 ± 0.053
120	0.081 ± 0.005 ^b		
300	0.021 ± 0.004 ^b	0.079 ± 0.022	
360			0.204 ± 0.013
480	0.012 ± 0.003	0.032 ± 0.006	
720		0.019 ± 0.003	0.037 ± 0.005
960			0.014 ± 0.004
Month 12			
0	0.319 ± 0.059 ^b	1.248 ± 0.205 ^b	3.010 ^c
30	0.162 ± 0.006 ^b	0.717 ± 0.002 ^b	1.400 ± 0.071
60	0.138 ± 0.008		
90		0.398 ± 0.030	0.767 ± 0.048
120	0.096 ± 0.005		
300	0.031 ^c	0.107 ± 0.013	
360			0.279 ^c
480	0.019 ± 0.003 ^b	0.080 ± 0.007	
720		0.037 ± 0.010	0.076 ± 0.002
960			0.047 ± 0.011
Month 18			
0	0.323 ± 0.016	1.052 ± 0.059	2.463 ± 0.225
30	0.204 ± 0.011	0.560 ± 0.014	1.260 ± 0.036
60	0.168 ± 0.002		
90		0.429 ± 0.016	0.806 ± 0.058
120	0.129 ± 0.002		
300	0.049 ± 0.003	0.177 ± 0.013	
360			0.282 ± 0.031
480	0.031 ± 0.004	0.100 ± 0.012	
720		0.061 ± 0.011	0.111 ± 0.009
960			0.062 ± 0.002

^a Data are given in µg/mL as the mean ± standard error.

^b n=2

^c n=1; no standard error calculated

TABLE D3
Blood Concentrations of Naphthalene in B6C3F₁ Mice after a Single 6-Hour Inhalation Exposure^a

Time after Exposure (minutes)	10 ppm	30 ppm
n	3	3
Male		
0	0.594 ± 0.300	1.953 ± 0.325 ^b
30	0.129 ± 0.073	1.355 ± 0.125 ^b
60	0.049 ± 0.014	0.447 ± 0.143
90	0.022 ± 0.000	0.214 ± 0.036
120	0.038 ± 0.010	0.219 ± 0.066
240	0.023 ± 0.004	0.199 ± 0.076
360	0.021 ± 0.001	0.084 ± 0.034
480	0.020 ± 0.001	0.028 ± 0.009
Female		
0	0.271 ± 0.057	1.763 ± 0.443
30	0.066 ± 0.028	0.786 ± 0.148
60	0.052 ± 0.013 ^b	0.269 ± 0.102
90	0.036 ± 0.003 ^b	0.122 ± 0.016
120	0.041 ± 0.011	0.115 ± 0.048
240	0.038 ± 0.008	0.033 ± 0.010
480	0.031 ^c	

^a Data are given in µg/mL as the mean ± standard error.

^b n=2

^c n=1; no standard error calculated

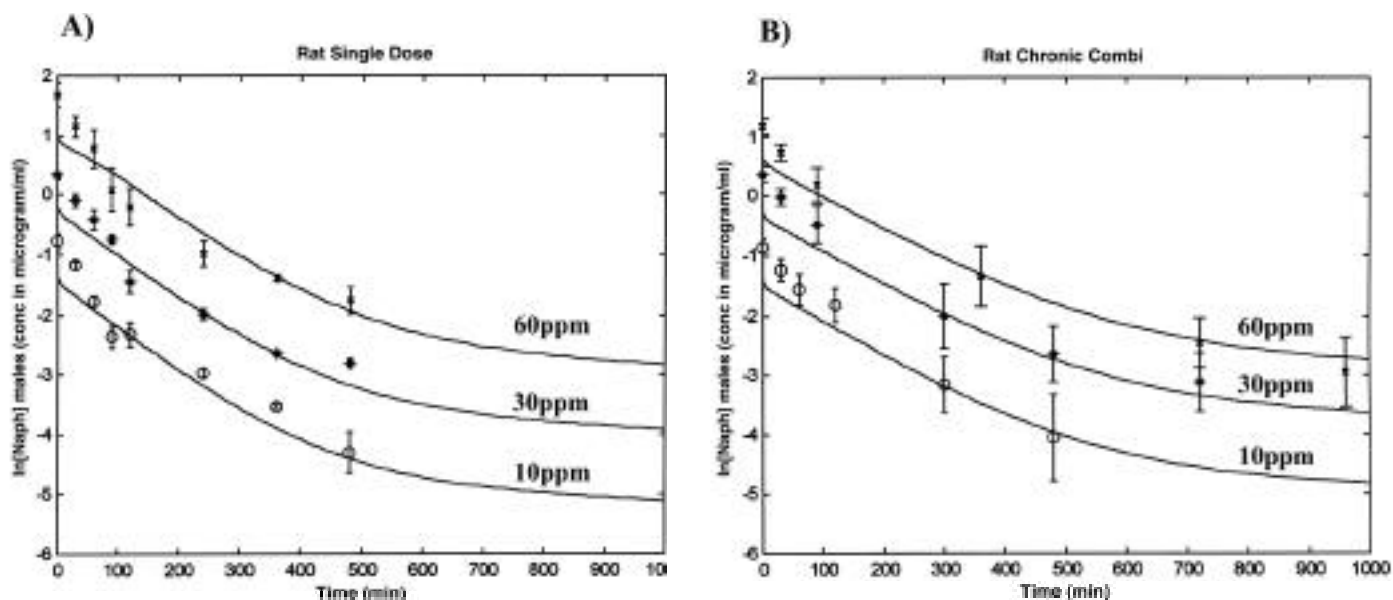

Figure D2
Blood Concentrations of Naphthalene (mean \pm standard deviation, in $\mu\text{g}/\text{mL}$)
in Male Rats after (A) a Single Exposure or (B) Exposure for 2 Weeks or 3, 6, 12, or 18 Months
to Naphthalene by Inhalation

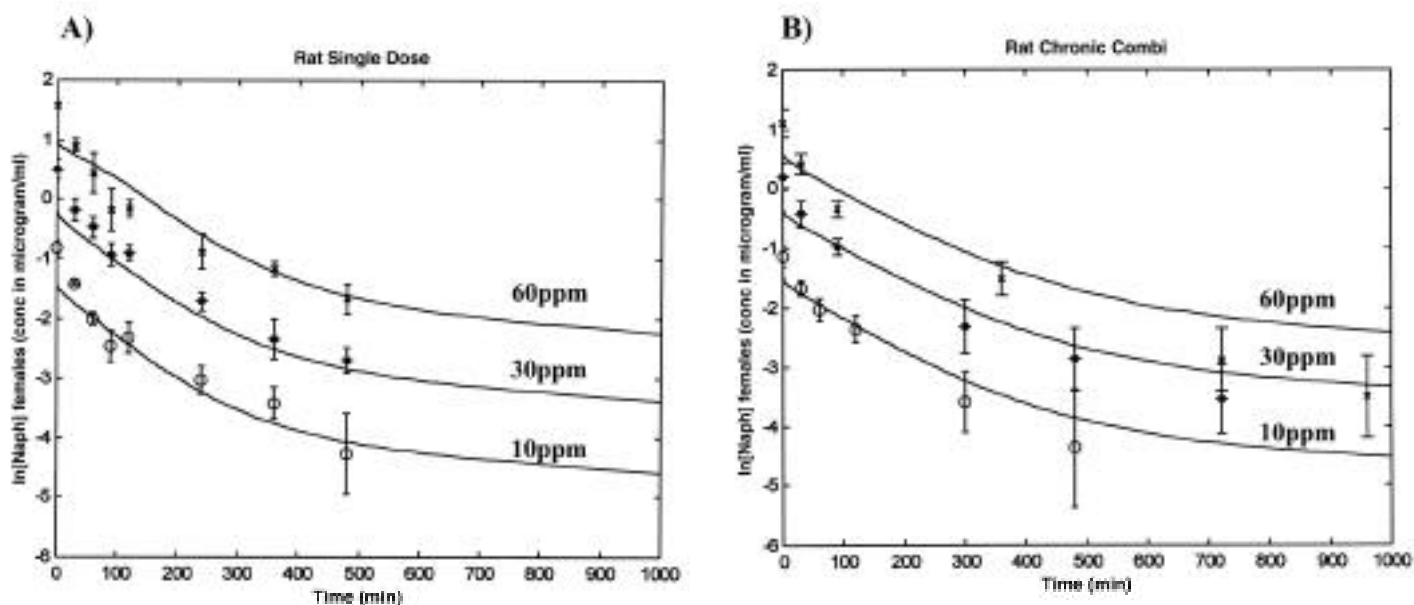

Figure D3
Blood Concentrations of Naphthalene (mean \pm standard deviation, in $\mu\text{g}/\text{mL}$)
in Female Rats after (A) a Single Exposure or (B) Exposure for 2 Weeks or 3, 6, 12, or 18 Months
to Naphthalene by Inhalation

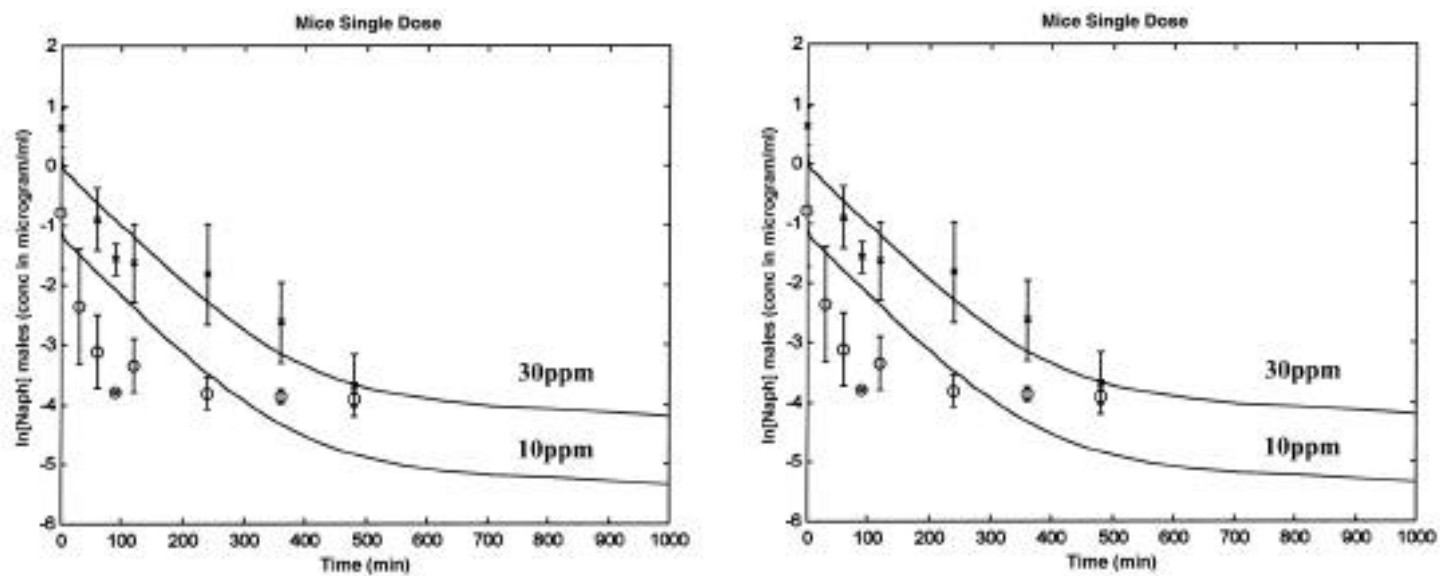

Figure D4
Blood Concentrations of Naphthalene (mean \pm standard deviation, in $\mu\text{g/mL}$)
in Male and Female Mice after a Single Exposure to Naphthalene by Inhalation

TABLE D4
Cardiac Output, Organ Volumes, Organ Blood Perfusion Rates, and Optimized Metabolic Parameters of Rats and Mice for the Physiologically Based Pharmacokinetic Model of Naphthalene^a

	Rats		Mice	
	Male	Female	Male	Female
Body Weight (kg)	0.125 – 0.504	0.1 – 0.306	30	30
Cardiac Output (L/hr/kg^{0.7})	14.7	14.7	11.9	11.9
Ventilation Rate (L/hr/kg^{0.7})	20	20	24.4	24.4
Tissue Volumes (% of body weight)				
Arterial blood	1.8	1.8	2	2
Venous blood	3.6	3.6	4	4
Alveolar space ^b	0.5	0.5	0.5	0.5
Lung ^c	0.52	0.52	0.6	0.6
Liver ^d	3.7	3.7	5.5	5.5
Fat ^d	7.0	7.0	6	6
Kidney	1.48	1.48	1.7	1.7
Other (residual value)	81.4	81.4	79.7	79.7
Tissue Capillary Volumes (% of tissue volume)^e				
Lung	18.0	18.0	11	11
Liver	13.8	13.8	11	11
Fat	2.0	2.0	3	3
Kidney	16.0	16.0	10.2	10.2
Other	4.5	4.5	4.2	4.2
Tissue Blood Flow (% of cardiac output)^f				
Liver	17.4	17.4	16.2	16.2
Fat	7.0	7.0	5	5
Kidney	14.1	14.1	16.3	16.3
Other	61.5	61.5	62.5	62.5
Metabolic Parameters^g				
V _{maxliver1}	6.5	5.8	229.6	124.5
K _{mliver1}	1.2	1.2	40.2	6.0
V _{maxliver2}	0.96	1.34	201.4	205.7
K _{mliver2}	1.55	1.37	99.6	20.7
Hill constant	2	2	2	2
V _{maxlung}	0.75	0.75	58.1	44.5
K _{mlung}	1.2	1.2	40.2	6.0
Permeability				
Fat	0.23	0.30	1.2	0.22
Other Tissues	0.54	0.39	2.7	1.9

^a Body weights are given as ranges from weeks 1 through 76 for the 2-year core study rats. Blood and organ volumes are scaled to the changing body weights.

^b Davies and Morris (1993)

^c Schmidt-Nielson (1979)

^d Average of several literature values

^e Altman and Dittmer (1971); Brown *et al.* (1997)

^f Brown *et al.* (1997)

^g V_{max}=maximum velocity of saturable metabolism (nmol/mL per minute); K_m=Michaelis-Menten constant for metabolism (nmol/mL)

TABLE D5
Model-Based Estimates of Naphthalene Concentration and Metabolism in the Liver and Lung of Rats^a

	10 ppm	30 ppm	60 ppm
Male			
End of 6-Hour Exposure			
Lung			
Steady-state concentration (µg/mL)	0.5	1.8	5.3
Metabolic rate at steady state (mg/hr/mL)	0.0043	0.0049	0.0056
Cumulative metabolism (mg/kg)	0.16	0.16	0.16
Liver			
Steady-state concentration (µg/mL)	0.06	0.7	12.3
Metabolic rate at steady state (mg/hr/mL)	0.013	0.04	0.05
Cumulative metabolism (mg/kg)	2.4	7.2	10.4
18 Hours Postexposure			
Cumulative metabolism (mg/kg)			
Lung	0.248	0.376	0.52
Liver	3.36	10.3	19.6
Total			
Naphthalene metabolized (mg/kg)	3.6	10.7	20.1
Naphthalene inhaled (mg/kg)	11.7	35.0	70.1
Inhaled dose metabolized (%)	30.8	30.5	28.7
Female			
End of 6-Hour Exposure			
Lung			
Steady-state concentration (µg/mL)	0.54	1.8	5.3
Metabolic rate at steady state (mg/hr/mL)	0.0047	0.0055	0.0055
Cumulative metabolism (mg/kg)	0.13	0.16	0.17
Liver			
Steady-state concentration (µg/mL)	0.07	1.2	13.4
Metabolic rate at steady state (mg/hr/mL)	0.014	0.038	0.047
Cumulative metabolism (mg/kg)	2.5	7.1	9.7
18 Hours Postexposure			
Cumulative metabolism (mg/kg)			
Lung	0.3	0.4	0.6
Liver	3.6	11	20
Total			
Naphthalene metabolized (mg/kg)	3.9	11.4	20.6
Naphthalene inhaled (mg/kg)	15.7	46.9	93.9
Inhaled dose metabolized (%)	24.8	24.3	21.9

^a For male rats, body weight=125 g, lung tissue volume=0.67 mL, liver tissue volume=4.78 mL. For female rats, body weight=100 g, lung tissue volume=0.53 mL, liver tissue volume=3.78 mL

TABLE D6
Model-Based Estimates of Naphthalene Concentration and Metabolism in the Liver and Lung of Mice^a

	10 ppm	30 ppm
Male		
End of 6-Hour Exposure		
Lung		
Steady-state concentration (µg/mL)	0.88	2.8
Metabolic rate at steady state (mg/hr/mL)	0.06	0.16
Cumulative metabolism (mg/kg)	2.1	5
Liver		
Steady-state concentration (µg/mL)	0.1	0.34
Metabolic rate at steady state (mg/hr/mL)	0.035	0.11
Cumulative metabolism (mg/kg)	10	31.3
18 Hours Postexposure		
Cumulative metabolism (mg/kg)		
Lung	3	7.7
Liver	14.3	45.3
Total		
Naphthalene metabolized (mg/kg)	17.3	53.0
Naphthalene inhaled (mg/kg)	25.7	76.7
Inhaled dose metabolized (%)	67.3	69.1
Female		
End of 6-Hour Exposure		
Lung		
Steady-state concentration (µg/mL)	0.67	2.6
Metabolic rate at steady state (mg/hr/mL)	0.16	0.27
Cumulative metabolism (mg/kg)	5.4	9.2
Liver		
Steady-state concentration (µg/mL)	0.022	0.092
Metabolic rate at steady state (mg/hr/mL)	0.027	0.10
Cumulative metabolism (mg/kg)	7.9	29.6
18 Hours Postexposure		
Cumulative metabolism (mg/kg)		
Lung	7.08	12.9
Liver	10.4	38.7
Total		
Naphthalene metabolized (mg/kg)	17.5	51.6
Naphthalene inhaled (mg/kg)	25.7	76.7
Inhaled dose metabolized (%)	63.5	62.8

^a For male mice, body weight=30 g, lung tissue volume=0.18 mL, liver tissue volume=1.65 mL. For female mice, body weight=24 g, lung tissue volume=0.14 mL, liver tissue volume=1.32 mL

APPENDIX E

CHEMICAL CHARACTERIZATION AND GENERATION OF CHAMBER CONCENTRATIONS

PROCUREMENT AND CHARACTERIZATION OF NAPHTHALENE	156
VAPOR GENERATION AND EXPOSURE SYSTEM	156
VAPOR CONCENTRATION MONITORING	157
CHAMBER ATMOSPHERE CHARACTERIZATION	157
FIGURE E1 Infrared Absorption Spectrum of Naphthalene	159
FIGURE E2 Nuclear Magnetic Resonance Spectrum of Naphthalene	160
TABLE E1 Gas Chromatography Systems Used in the Inhalation Study of Naphthalene	161
FIGURE E3 Schematic of the Vapor Generation and Delivery System in the 2-Year Inhalation Study of Naphthalene	162
TABLE E2 Summary of Chamber Concentrations in the 2-Year Inhalation Study of Naphthalene in Rats	163

CHEMICAL CHARACTERIZATION AND GENERATION OF CHAMBER CONCENTRATIONS

PROCUREMENT AND CHARACTERIZATION OF NAPHTHALENE

Naphthalene was obtained from Aldrich Chemical Company (Milwaukee, WI) in one lot (09820LG) for use during the 2-year study. Identity and purity analyses were conducted by the analytical chemistry laboratory, Research Triangle Institute (Research Triangle Park, NC) and by the study laboratory, Battelle Toxicology Northwest (Richland, WA). Reports on analyses performed in support of the naphthalene study are on file at the National Institute of Environmental Health Sciences.

The chemical, a white crystalline solid, was identified as naphthalene by the analytical chemistry laboratory with infrared and proton nuclear magnetic resonance spectroscopy and by gas chromatography/mass spectrometry by system A (Table E1). The chemical was identified as naphthalene by the study laboratory with infrared spectroscopy. Chemir/Polytech Industries (Maryland Heights, MO) compared samples of lot 09820LG obtained from the analytical chemistry laboratory and the study laboratory using proton and ¹³C nuclear magnetic resonance spectroscopy; the spectra of the samples from each laboratory were similar. All spectra were consistent with the literature spectra (*Sadtler Standard Spectra; Wiley Mass Spectral Database; Aldrich, 1985*) of naphthalene. The infrared and nuclear magnetic resonance spectra are presented in Figures E1 and E2.

The purity of lot 09820LG was determined by elemental analyses, gas chromatography/mass spectrometry, and gas chromatography with flame ionization detection (FID). Elemental analyses were performed by Chemir/Polytech Laboratories. Purity analysis by gas chromatography/mass spectrometry using system A was performed by the analytical chemistry laboratory. Purity analysis of each of the 15 drums of lot 09820LG was performed by the study laboratory with gas chromatography/FID using systems B and C.

Elemental analyses for carbon and hydrogen were in agreement with the theoretical values for naphthalene; additionally, 0.12% sulfur was detected. Gas chromatography/mass spectrometry indicated no impurities. Gas chromatography/FID indicated one major peak and one impurity with an area of approximately 0.6% relative to the major peak area; the impurity was tentatively identified as thionaphthene by gas chromatography (system C) and an authentic standard of thionaphthene. The overall purity of lot 09820LG was determined to be greater than 99%. The results of analyses of individual drums of this lot indicated no differences between the drums.

The bulk chemical was stored under a nitrogen headspace at room temperature in 6-gallon, plastic-lined, metal drums. Stability of the bulk chemical was monitored by the study laboratory throughout the study with gas chromatography using systems B and C. No degradation of the bulk chemical was detected.

VAPOR GENERATION AND EXPOSURE SYSTEM

A diagram of the naphthalene generation and delivery system is shown in Figure E3. Naphthalene was heated in a flask surrounded by a heated mantle. Heated nitrogen metered into the flask carried the vaporized naphthalene out of the generator. The flask was replaced every 2 weeks. The mantle and nitrogen temperatures were adjusted to maintain the naphthalene vapor temperature above the bulk naphthalene at 66° to 71° C. A temperature probe was used to monitor the bulk chemical to ensure that its temperature was maintained below the melting point (80° to 82° C).

A heated Teflon[®] line transported the vapor to the exposure room. The vapor was mixed with heated, HEPA- and charcoal-filtered air before it entered a vapor distribution manifold. From the distribution manifold, an AirVac pump (Air-Vac Engineering Co., Inc., Milford, CT) withdrew the appropriate amount of naphthalene vapor into the heated Teflon[®] delivery lines to obtain the target concentration. Flow from the manifold into the delivery line was controlled by a chamber exposure valve which diverted vapor to the exhaust until the concentration of naphthalene was stable. When the valve was in the exposure position, the naphthalene vapor was injected into the chamber inlet duct where it was further diluted with conditioned chamber air.

The study laboratory designed the inhalation exposure chamber (Harford Systems Division of Lab Products, Inc., Aberdeen, MD) so that uniform vapor concentrations could be maintained throughout the chamber with the catch pans in place. The total active mixing volume of each chamber was 1.7 m³. Before the study began, a small particle detector (Type CN, Gardner Associates, Schenectady, NY) was used with and without animals in the exposure chambers to ensure that naphthalene vapor, and not aerosol, was produced. A Type CN small particle detector was also used to determine the maximum attainable concentration without aerosolization. Naphthalene aerosol was detected at up to 1,950 particles/cm³ at vapor concentrations of approximately 85 to 115 ppm; therefore, a maximum concentration of 60 ppm was selected. During the study, no particle counts above the minimum resolvable level (approximately 200 particles/cm³) were detected.

VAPOR CONCENTRATION MONITORING

A summary of the chamber concentrations for the study is in Table E2. The naphthalene concentrations in the exposure chambers were monitored by an on-line gas chromatograph (system D). Samples were drawn from each exposure chamber approximately every 24 minutes using a 12-port stream select valve (Valco Instruments Company, Houston, TX). The online gas chromatograph was checked throughout the day for instrument drift against an on-line standard of naphthalene in nitrogen supplied by a diffusion tube standard generator (Model 360, Thermo Environmental Instruments, Franklin, MA). The online gas chromatograph was calibrated monthly by a comparison of chamber concentration data to data from grab samples, which were collected with charcoal sampling tubes (ORBO[™]-101, Supelco, Bellefonte, PA), extracted with toluene containing 1-phenylhexane as an internal standard, and analyzed by an off-line gas chromatograph (system E). The volumes of gas were sampled at a constant flow rate ensured by a calibrated critical orifice. The off-line gas chromatograph was calibrated with gravimetrically prepared standards of naphthalene containing 1-phenylhexane as an internal standard in toluene.

CHAMBER ATMOSPHERE CHARACTERIZATION

Buildup and decay rates for chamber vapor concentrations were determined with and without animals present in the chambers. At a chamber airflow rate of 15 air changes per hour, the theoretical value for the time to achieve 90% of the target concentration after the beginning of vapor generation (T_{90}) and the time for the chamber concentration to decay to 10% of the target concentration after vapor generation was terminated (T_{10}) was approximately 12.5 minutes. T_{90} values ranged from 9 to 12 minutes without animals present and from 9 to 14 minutes with animals present; T_{10} values ranged from 12 to 14 minutes without animals present and from 17 to 68 minutes with animals present. A T_{90} value of 12 minutes was selected for the study.

The uniformity of naphthalene vapor concentration in the inhalation exposure chambers without animals was evaluated before the study began; concentration uniformity with animals present in the chambers was measured periodically during the study. The vapor concentration was determined with the on-line gas chromatograph. The automatic 12-port sampling valve was disabled to allow continuous monitoring from a

single line. Samples were collected from several positions in each chamber. Chamber concentration uniformity was maintained throughout the study.

The persistence of naphthalene in the chamber after vapor delivery ended was determined by monitoring the concentration overnight in the 60 ppm chamber, with and without animals present in the chambers. The concentration decreased to less than 1% of the target concentration within 327 minutes with animals present and within 238 minutes without animals present.

The stability of naphthalene in the 10 and 60 ppm exposure chambers, the distribution line, and the generator reservoir flask was monitored by analyzing grab samples with gas chromatography by systems C and E. Samples were collected before the studies began without animals present in the chambers and during the study with animals present. Commercial standards of potential degradation products and impurities were obtained from Aldrich Chemical Company (Milwaukee, WI). Two standard 0.5 and 5 µg/mL naphthalene mixtures were analyzed by system E. 1,2-Naphthoquinone was detected only in the 5 µg/mL standard; all other degradation products and impurities were detected in each standard mixture. Thionaphthene was the only impurity with a peak area greater than 0.1% relative to the major peak area, and no impurities were detected in the exposure chamber samples that were not present in the bulk material. Samples were taken from the generator reservoir at the end of weeks 1 and 2 of exposure and from the bulk chemical, exposure chambers, and distribution line at the beginning and end of an exposure period. A slight brown discoloration was observed at the bottom of the generator flask at the end of week 2; samples of the discolored material were also analyzed. Thionaphthene was the only impurity detected in the sample with a peak area greater than 0.1% relative to the major peak area. Approximately 0.5% to 0.7% thionaphthene was present in the bulk chemical and in the generator flask samples; 0.4% to 0.5% was detected in the distribution line and exposure chambers.

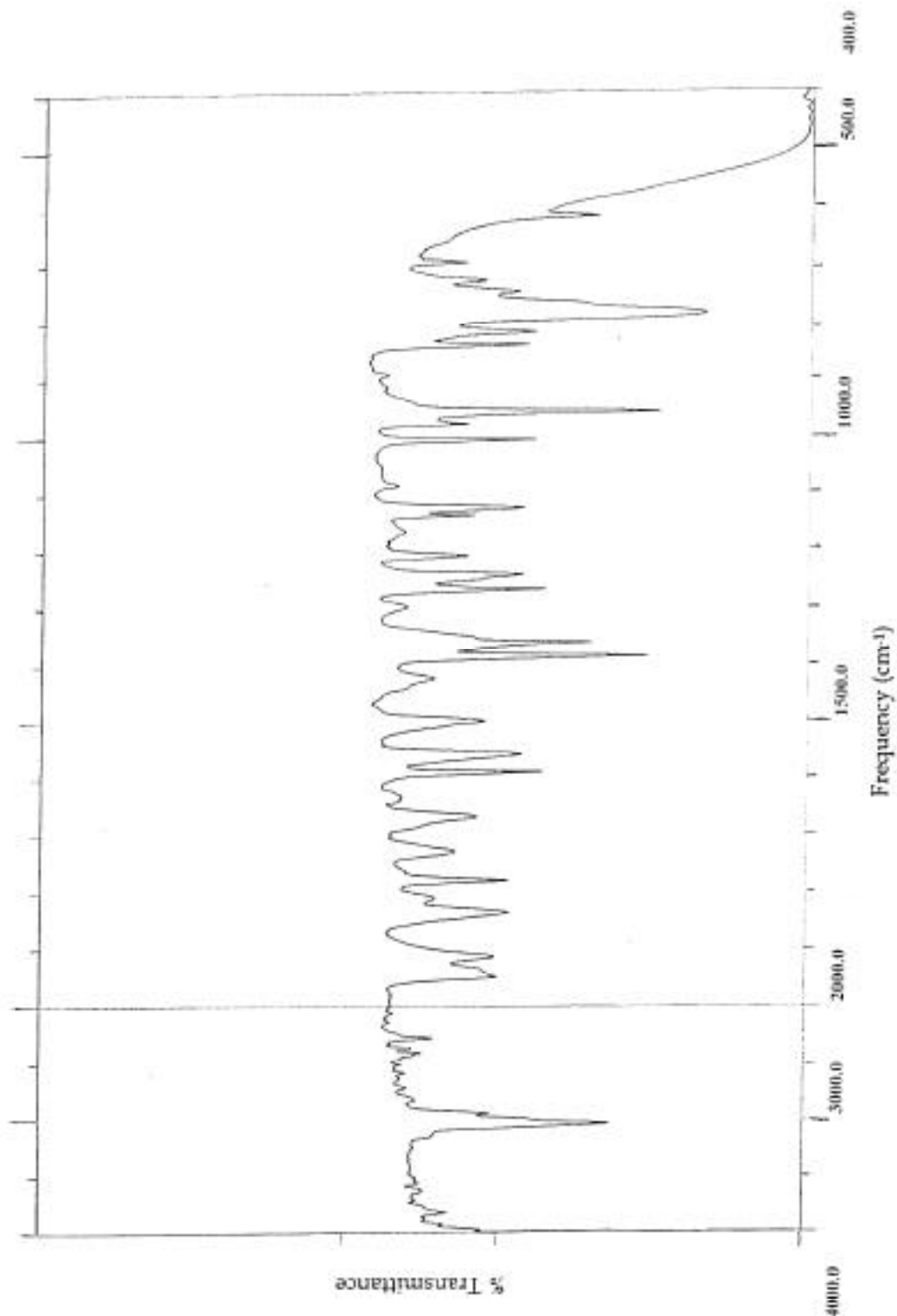

Figure E1
Infrared Absorption Spectrum of Naphthalene

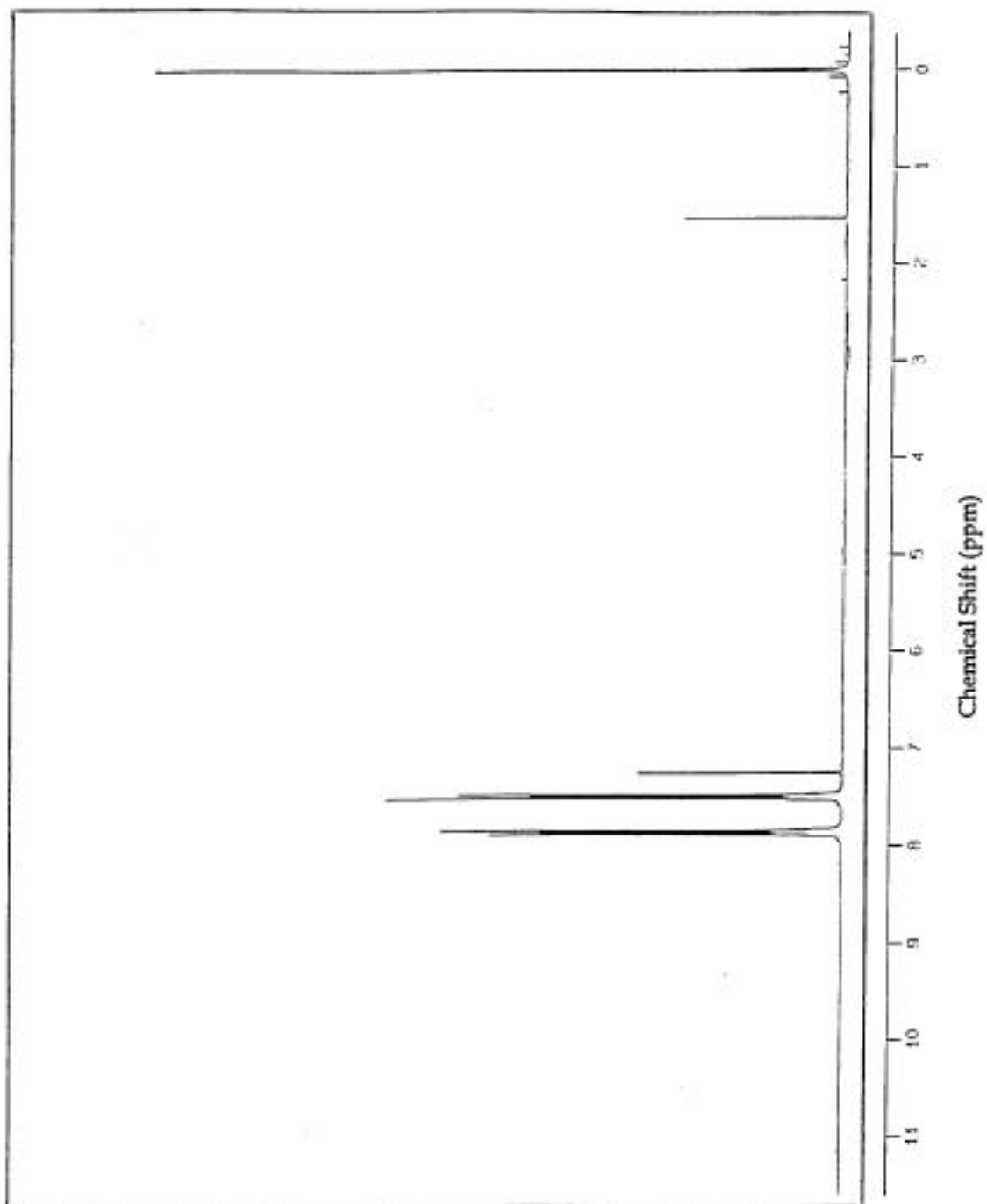

Figure E2
Nuclear Magnetic Resonance Spectrum of Naphthalene

TABLE E1
Gas Chromatography Systems Used in the Inhalation Study of Naphthalene^a

Detection System	Column	Carrier Gas	Oven Temperature Program
System A Quadrupole mass spectrometer with electron impact ionization (70 eV)	DB-5, 30 m × 0.25 mm, 0.25 μm film (J&W Scientific, Folsom, CA)	Helium at 1.2 mL/minute	50° C for 0.5 minutes, then 15° C/minute to 280° C
System B Flame ionization	DB-5, 30 m × 0.25 mm, 1 μm film (J&W Scientific)	Helium at 24 psi head pressure	50° C for 1 minute, then 4° C/minute to 200° C, then 20° C/minute to 300° C
System C Flame ionization	DB-5, 30 m × 0.25 mm, 1 μm film (J&W Scientific)	Helium at 24 psi head pressure	50° C for 1 minute, then 4° C/minute to 200° C, then 15° C/minute to 300° C
System D Flame ionization	DB-5, 30 m × 0.53 mm, 1.5 μm film (J&W Scientific)	Nitrogen at approximately 25 mL/minute	Isothermally at 175° C
System E Flame ionization	DB-5, 30 m × 0.53 mm, 1.5 μm film (J&W Scientific)	Helium at 6 psi head pressure	60° C for 1 minute, then 16° C/minute to 200° C

^a All gas chromatographs were model 5890, manufactured by Hewlett-Packard (Palo Alto, CA).

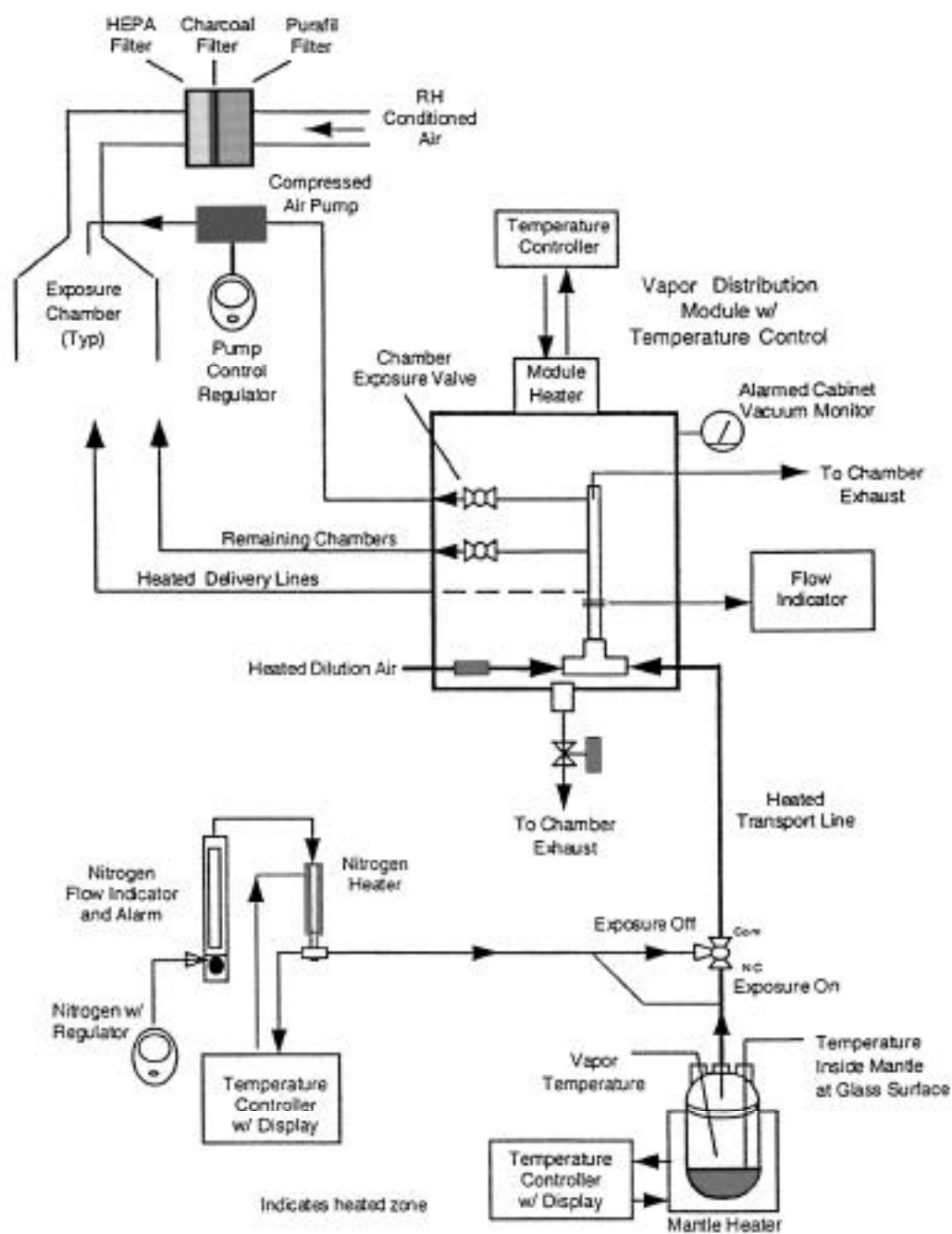

Figure E3
Schematic of the Vapor Generation and Delivery System
in the 2-Year Inhalation Study of Naphthalene

TABLE E2
Summary of Chamber Concentrations in the 2-Year Inhalation Study of Naphthalene in Rats

Target Concentration (ppm)	Total Number of Readings	Average Concentration ^a (ppm)
10	8,549	10.0 ± 0.7
30	8,531	30.2 ± 1.7
60	8,542	60.3 ± 3.9

^a Mean ± standard deviation

APPENDIX F
INGREDIENTS, NUTRIENT COMPOSITION,
AND CONTAMINANT LEVELS
IN NTP-2000 RAT AND MOUSE RATION

TABLE F1	Ingredients of NTP-2000 Rat and Mouse Ration	166
TABLE F2	Vitamins and Minerals in NTP-2000 Rat and Mouse Ration	166
TABLE F3	Nutrient Composition of NTP-2000 Rat and Mouse Ration	167
TABLE F4	Contaminant Levels in NTP-2000 Rat and Mouse Ration	168

TABLE F1
Ingredients of NTP-2000 Rat and Mouse Ration

Ingredients	Percent by Weight
Ground hard winter wheat	22.26
Ground #2 yellow shelled corn	22.18
Wheat middlings	15.0
Oat hulls	8.5
Alfalfa meal (dehydrated, 17% protein)	7.5
Purified cellulose	5.5
Soybean meal (49% protein)	5.0
Fish meal (60% protein)	4.0
Corn oil (without preservatives)	3.0
Soy oil (without preservatives)	3.0
Dried brewer's yeast	1.0
Calcium carbonate (USP)	0.9
Vitamin premix ^a	0.5
Mineral premix ^b	0.5
Calcium phosphate, dibasic (USP)	0.4
Sodium chloride	0.3
Choline chloride (70% choline)	0.26
Methionine	0.2

^a Wheat middlings as carrier

^b Calcium carbonate as carrier

TABLE F2
Vitamins and Minerals in NTP-2000 Rat and Mouse Ration^a

	Amount	Source
Vitamins		
A	4,000 IU	Stabilized vitamin A palmitate or acetate
D	1,000 IU	D-activated animal sterol
K	1.0 mg	Menadione sodium bisulfite complex
α -Tocopheryl acetate	100 IU	
Niacin	23 mg	
Folic acid	1.1 mg	
<i>d</i> -Pantothenic acid	10 mg	<i>d</i> -Calcium pantothenate
Riboflavin	3.3 mg	
Thiamine	4 mg	Thiamine mononitrate
B ₁₂	52 μ g	
Pyridoxine	6.3 mg	Pyridoxine hydrochloride
Biotin	0.2 mg	<i>d</i> -Biotin
Minerals		
Magnesium	514 mg	Magnesium oxide
Iron	35 mg	Iron sulfate
Zinc	12 mg	Zinc oxide
Manganese	10 mg	Manganese oxide
Copper	2.0 mg	Copper sulfate
Iodine	0.2 mg	Calcium iodate
Chromium	0.2 mg	Chromium acetate

^a Per kg of finished product

TABLE F3
Nutrient Composition of NTP-2000 Rat and Mouse Ration

Nutrient	Mean ± Standard Deviation	Range	Number of Samples
Protein (% by weight)	13.5 ± 0.52	12.5 – 14.7	23
Crude fat (% by weight)	8.1 ± 0.31	7.5 – 8.7	23
Crude fiber (% by weight)	9.6 ± 0.51	8.5 – 10.3	23
Ash (% by weight)	5.0 ± 0.16	4.8 – 5.4	23
Amino Acids (% of total diet)			
Arginine	0.732 ± 0.050	0.670 – 0.800	6
Cystine	0.220 ± 0.011	0.210 – 0.240	6
Glycine	0.683 ± 0.048	0.620 – 0.740	6
Histidine	0.333 ± 0.020	0.310 – 0.350	6
Isoleucine	0.522 ± 0.054	0.430 – 0.590	6
Leucine	1.065 ± 0.070	0.960 – 1.130	6
Lysine	0.705 ± 0.066	0.620 – 0.790	6
Methionine	0.402 ± 0.042	0.350 – 0.460	6
Phenylalanine	0.600 ± 0.042	0.540 – 0.640	6
Threonine	0.512 ± 0.056	0.430 – 0.590	6
Tryptophan	0.125 ± 0.015	0.110 – 0.150	6
Tyrosine	0.410 ± 0.037	0.360 – 0.460	6
Valine	0.628 ± 0.052	0.550 – 0.690	6
Essential Fatty Acids (% of total diet)			
Linoleic	3.98 ± 0.325	3.59 – 4.54	6
Linolenic	0.30 ± 0.048	0.21 – 0.35	6
Vitamins			
Vitamin A (IU/kg)	4,598 ± 1,184	2,780 – 8,140	23
Vitamin D (IU/kg)	1,000 ^a		
α-Tocopherol (ppm)	77.2 ± 10.94	62.2 – 87.1	6
Thiamine (ppm) ^b	8.1 ± 1.30	6.0 – 11.0	23
Riboflavin (ppm)	5.6 ± 1.24	4.20 – 7.70	6
Niacin (ppm)	73.1 ± 4.13	66.4 – 78.8	6
Pantothenic acid (ppm)	24.2 ± 2.92	21.4 – 29.1	6
Pyridoxine (ppm)	9.37 ± 2.50	6.7 – 12.4	6
Folic acid (ppm)	1.70 ± 0.43	1.26 – 2.32	6
Biotin (ppm)	0.349 ± 0.18	0.225 – 0.704	6
Vitamin B ₁₂ (ppb)	83.4 ± 67.1	30.0 – 174.0	6
Choline (ppm)	3,082 ± 232	2,700 – 3,400	6
Minerals			
Calcium (%)	0.965 ± 0.043	0.867 – 1.050	23
Phosphorus (%)	0.566 ± 0.020	0.533 – 0.620	23
Potassium (%)	0.660 ± 0.026	0.627 – 0.691	6
Chloride (%)	0.356 ± 0.031	0.300 – 0.392	6
Sodium (%)	0.193 ± 0.020	0.160 – 0.212	6
Magnesium (%)	0.197 ± 0.010	0.185 – 0.213	6
Sulfur (%)	0.182 ± 0.023	0.153 – 0.209	6
Iron (ppm)	158 ± 15.2	135 – 173	6
Manganese (ppm)	51.8 ± 4.05	46.2 – 56.0	6
Zinc (ppm)	53.2 ± 5.68	45.0 – 61.1	6
Copper (ppm)	6.49 ± 0.786	5.38 – 7.59	6
Iodine (ppm)	0.487 ± 0.204	0.233 – 0.843	6
Chromium (ppm)	0.763 ± 0.620	0.330 – 2.000	6
Cobalt (ppm)	0.53 ± 0.720	0.20 – 2.0	6

^a From formulation

^b As hydrochloride

TABLE F4
Contaminant Levels in NTP-2000 Rat and Mouse Ration^a

	Mean ± Standard Deviation ^b	Range	Number of Samples
Contaminants			
Arsenic (ppm)	0.25 ± 0.139	0.10 – 0.50	23
Cadmium (ppm)	0.05 ± 0.014	0.04 – 0.10	23
Lead (ppm)	0.09 ± 0.033	0.06 – 0.20	23
Mercury (ppm)	<.02		23
Selenium (ppm)	0.16 ± 0.034	0.11 – 0.26	23
Aflatoxins (ppb)	<5.00		23
Nitrate nitrogen (ppm) ^c	17.0 ± 7.78	9.0 – 39.6	23
Nitrite nitrogen (ppm) ^c	0.72 ± 0.406	0.40 – 2.00	23
BHA (ppm) ^d	1.1 ± 0.44	0.01 – 2.47	23
BHT (ppm) ^d	1.0 ± 0.31	0.01 – 1.80	23
Aerobic plate count (CFU/g) ^e	231,600 ± 429,635	25,000 – 1,000,000	5
Coliform (MPN/g) ^e	11 ± 11	3 – 30	5
<i>Escherichia coli</i> (MPN/g)	<10		23
<i>Salmonella</i> (MPN/g)	Negative		23
Total nitrosoamines (ppb) ^f	5.7 ± 3.79	2.1 – 20.9	23
<i>N</i> -Nitrosodimethylamine (ppb) ^f	2.5 ± 1.79	1.0 – 6.4	23
<i>N</i> -Nitrosopyrrolidine (ppb) ^f	3.3 ± 2.82	1.0 – 14.5	23
Pesticides (ppm)			
α-BHC	<0.01		23
β-BHC	<0.02		23
γ-BHC	<0.01		23
δ-BHC	<0.01		23
Heptachlor	<0.01		23
Aldrin	<0.01		23
Heptachlor epoxide	<0.01		23
DDE	<0.01		23
DDD	<0.01		23
DDT	<0.01		23
HCB	<0.01		23
Mirex	<0.01		23
Methoxychlor	<0.05		23
Dieldrin	<0.01		23
Endrin	<0.01		23
Telodrin	<0.01		23
Chlordane	<0.05		23
Toxaphene	<0.10		23
Estimated PCBs	<0.20		23
Ronnel	<0.01		23
Ethion	<0.02		23
Trithion	<0.05		23
Diazinon	<0.10		23
Methyl chlorpyrifos	0.072 ± 0.061	0.010 – 0.220	22
Methyl parathion	<0.02		23
Ethyl parathion	<0.02		23
Malathion	0.157 ± 0.178	0.020 – 0.830	23
Endosulfan I	<0.01		23
Endosulfan II	<0.01		23
Endosulfan sulfate	<0.03		23

^a CFU=colony-forming units; MPN=most probable number; BHC=hexachlorocyclohexane or benzene hexachloride

^b For values less than the limit of detection, the detection limit is given as the mean.

^c Sources of contamination: alfalfa, grains, and fish meal

^d Sources of contamination: soy oil and fish meal

^e Nonirradiated samples. Microbial counts for irradiated samples were below the detection limit.

^f All values were corrected for percent recovery.

APPENDIX G

SENTINEL ANIMAL PROGRAM

METHODS	170
RESULTS	170

SENTINEL ANIMAL PROGRAM

METHODS

Rodents used in the Carcinogenesis Program of the National Toxicology Program are produced in optimally clean facilities to eliminate potential pathogens that may affect study results. The Sentinel Animal Program is part of the periodic monitoring of animal health that occurs during the toxicologic evaluation of chemical compounds. Under this program, the disease state of the rodents is monitored via serology on sera from extra (sentinel) animals in the study rooms. These animals and the study animals are subject to identical environmental conditions. The sentinel animals come from the same production source and weanling groups as the animals used for the studies of chemical compounds.

Serum samples were collected from randomly selected rats during the 2-year study. Blood from each animal was collected and allowed to clot, and the serum was separated. The samples were processed appropriately and sent to Microbiological Associates, Inc., or MA BioServices, Inc. (Rockville, MD), for determination of antibody titers. The laboratory serology methods and viral agents for which testing was performed are tabulated below; the times at which blood was collected during the studies are also listed.

Method and Test

Time of Analysis

ELISA

Mycoplasma pulmonis

Study termination

PVM (pneumonia virus of mice)

6, 12, and 18 months, study termination

RCV/SDA (rat coronavirus/
sialodacryoadenitis virus)

6, 12, and 18 months, study termination

Sendai

6, 12, and 18 months, study termination

Immunofluorescence Assay

Mycoplasma arthritidis

Study termination

Parvovirus

Study termination

Hemagglutination Inhibition

H-1 (Toolan's H-1 virus)

6, 12, and 18 months

KRV (Kilham rat virus)

6, 12, and 18 months

RESULTS

All test results were negative.



National Toxicology Program

National Institute of Environmental Health Sciences

National Institutes of Health

P.O. Box 12233, MD K2-05

Durham, NC 27709

Tel: 984-287-3211

ntpwebrequest@niehs.nih.gov

<https://ntp.niehs.nih.gov>

ISSN 2378-8925