

NTP TECHNICAL REPORT
ON THE
TOXICOLOGY AND CARCINOGENESIS
STUDIES OF ISOBUTENE
(CAS NO. 115-11-7)
IN F344/N RATS AND B6C3F₁ MICE
(INHALATION STUDIES)

NATIONAL TOXICOLOGY PROGRAM
P.O. Box 12233
Research Triangle Park, NC 27709

December 1998

NTP TR 487

NIH Publication No. 99-3977

U.S. DEPARTMENT OF HEALTH AND HUMAN SERVICES
Public Health Service
National Institutes of Health

FOREWORD

The National Toxicology Program (NTP) is made up of four charter agencies of the U.S. Department of Health and Human Services (DHHS): the National Cancer Institute (NCI), National Institutes of Health; the National Institute of Environmental Health Sciences (NIEHS), National Institutes of Health; the National Center for Toxicological Research (NCTR), Food and Drug Administration; and the National Institute for Occupational Safety and Health (NIOSH), Centers for Disease Control. In July 1981, the Carcinogenesis Bioassay Testing Program, NCI, was transferred to the NIEHS. The NTP coordinates the relevant programs, staff, and resources from these Public Health Service agencies relating to basic and applied research and to biological assay development and validation.

The NTP develops, evaluates, and disseminates scientific information about potentially toxic and hazardous chemicals. This knowledge is used for protecting the health of the American people and for the primary prevention of disease.

The studies described in this Technical Report were performed under the direction of the NIEHS and were conducted in compliance with NTP laboratory health and safety requirements and must meet or exceed all applicable federal, state, and local health and safety regulations. Animal care and use were in accordance with the Public Health Service Policy on Humane Care and Use of Animals. The prechronic and chronic studies were conducted in compliance with Food and Drug Administration (FDA) Good Laboratory Practice Regulations, and all aspects of the chronic studies were subjected to retrospective quality assurance audits before being presented for public review.

These studies are designed and conducted to characterize and evaluate the toxicologic potential, including carcinogenic activity, of selected chemicals in laboratory animals (usually two species, rats and mice). Chemicals selected for NTP toxicology and carcinogenesis studies are chosen primarily on the bases of human exposure, level of production, and chemical structure. The interpretive conclusions presented in this Technical Report are based only on the results of these NTP studies. Extrapolation of these results to other species and quantitative risk analyses for humans require wider analyses beyond the purview of these studies. Selection *per se* is not an indicator of a chemical's carcinogenic potential.

Listings of all published NTP reports and ongoing studies are available from NTP Central Data Management, NIEHS, P.O. Box 12233, MD E1-02, Research Triangle Park, NC 27709 (919-541-3419). The Abstracts and other study information for 2-year studies are also available at the NTP's World Wide Web site: <http://ntp-server.niehs.nih.gov>.

NTP TECHNICAL REPORT
ON THE
TOXICOLOGY AND CARCINOGENESIS
STUDIES OF ISOBUTENE
(CAS NO. 115-11-7)
IN F344/N RATS AND B6C3F₁ MICE
(INHALATION STUDIES)

NATIONAL TOXICOLOGY PROGRAM
P.O. Box 12233
Research Triangle Park, NC 27709

December 1998

NTP TR 487

NIH Publication No. 99-3977

U.S. DEPARTMENT OF HEALTH AND HUMAN SERVICES
Public Health Service
National Institutes of Health

CONTRIBUTORS

National Toxicology Program

Evaluated and interpreted results and reported findings

J.H. Roycroft, Ph.D., Study Scientist
 D.A. Bridge, B.S.
 J.R. Bucher, Ph.D.
 R.E. Chapin, Ph.D.
 J.R. Hailey, D.V.M.
 J.K. Haseman, Ph.D.
 R.A. Herbert, D.V.M., Ph.D.
 R.R. Maronpot, D.V.M.
 G.N. Rao, D.V.M., Ph.D.
 C.S. Smith, Ph.D.
 G.S. Travlos, D.V.M.
 D.B. Walters, Ph.D.
 K.L. Witt, M.S., Integrated Laboratory Systems

Battelle Pacific Northwest Laboratory

Conducted studies, evaluated pathology findings for 14-week and 2-year studies in rats and mice

B.J. Chou, D.V.M., Ph.D., Principal Investigator
 J.A. Dill, Ph.D.
 S.L. Grumbein, D.V.M., Ph.D.
 R.A. Miller, D.V.M., Ph.D.
 E.W. Morgan, D.V.M.
 H.A. Ragan, D.V.M.
 R.A. Renne, D.V.M.
 S.E. Rowe, D.V.M., M.S.
 R.B. Westerberg, Ph.D.

Experimental Pathology Laboratories, Inc.

Provided pathology quality assurance

J.F. Hardisty, D.V.M., Principal Investigator
 C.C. Shackelford, D.V.M., M.S., Ph.D.

Dynamac Corporation

Prepared quality assurance audits

S. Brecher, Ph.D., Principal Investigator

NTP Pathology Working Group

Evaluated slides, prepared pathology report on rats (20 March 1997)

P.K. Hildebrandt, D.V.M., Chairperson
 PATHCO, Inc.
 S. Ching, D.V.M., Ph.D.
 Glaxo-Wellcome
 J. Dillberger, D.V.M., Ph.D., Observer
 Glaxo-Wellcome
 J.R. Hailey, D.V.M.
 National Toxicology Program
 R.A. Herbert, D.V.M., Ph.D.
 National Toxicology Program
 J.R. Leininger, D.V.M., Ph.D.
 National Toxicology Program
 J. Nold, D.V.M., Ph.D., Observer
 Pathology Associates International
 C.C. Shackelford, D.V.M., M.S., Ph.D.
 Experimental Pathology Laboratories, Inc.

Evaluated slides, prepared pathology report on mice (8 April 1997)

D.G. Goodman, V.M.D., Chairperson
 PATHCO, Inc.
 J. Everitt, D.V.M.
 Chemistry Industry Institute of Toxicology
 V. Geiss, D.V.M., Observer
 National Toxicology Program
 J.R. Hailey, D.V.M.
 National Toxicology Program
 R.A. Herbert, D.V.M., Ph.D.
 National Toxicology Program
 J.R. Leininger, D.V.M., Ph.D.
 National Toxicology Program
 A. Radovsky, D.V.M., Ph.D.
 National Toxicology Program
 C.C. Shackelford, D.V.M., M.S., Ph.D.
 Experimental Pathology Laboratories, Inc.

Analytical Sciences, Inc.

Provided statistical analyses

R.W. Morris, M.S., Principal Investigator

S.R. Lloyd, M.S.

N.G. Mintz, B.S.

Biotechnical Services, Inc.

Prepared Technical Report

S.R. Gunnels, M.A., Principal Investigator

L.M. Harper, B.S.

A.M. Macri-Hanson, M.A., M.F.A.

CONTENTS

ABSTRACT	5
EXPLANATION OF LEVELS OF EVIDENCE OF CARCINOGENIC ACTIVITY	8
TECHNICAL REPORTS REVIEW SUBCOMMITTEE	9
SUMMARY OF TECHNICAL REPORTS REVIEW SUBCOMMITTEE COMMENTS	10
INTRODUCTION	11
MATERIALS AND METHODS	17
RESULTS	29
DISCUSSION AND CONCLUSIONS	51
REFERENCES	53
APPENDIX A Summary of Lesions in Male Rats in the 2-Year Inhalation Study of Isobutene	59
APPENDIX B Summary of Lesions in Female Rats in the 2-Year Inhalation Study of Isobutene ...	95
APPENDIX C Summary of Lesions in Male Mice in the 2-Year Inhalation Study of Isobutene	125
APPENDIX D Summary of Lesions in Female Mice in the 2-Year Inhalation Study of Isobutene ...	153
APPENDIX E Genetic Toxicology	187
APPENDIX F Hematology and Clinical Chemistry Results	193
APPENDIX G Organ Weights and Organ-Weight-to-Body-Weight Ratios	199
APPENDIX H Reproductive Tissue Evaluations and Estrous Cycle Characterization	203
APPENDIX I 2-Hydroxyisobutyric Acid — Biomarker of Exposure	207
APPENDIX J Chemical Characterization and Generation of Chamber Concentrations	211
APPENDIX K Ingredients, Nutrient Composition, and Contaminant Levels in NIH-07 Rat and Mouse Ration	223
APPENDIX L Sentinel Animal Program	227

ABSTRACT

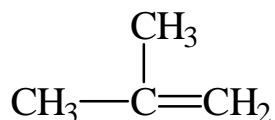

ISOBUTENE

CAS No. 115-11-7

Chemical Formula: C₄H₈ Molecular Weight: 56.10

Synonyms: γ -butylene, isobutylene, liquified petroleum gas, 2-methylpropene

Isobutene is produced during the fractionation of refinery gases or through the catalytic cracking of methyl-*t*-butyl ether. Isobutene is primarily used to produce diisobutylene, trimers, butyl rubber, and other polymers. In addition, it is used in the production of isooctane, high-octane aviation gasoline, methyl-*t*-butyl ether, and copolymer resins with butadiene and acrylonitrile. Isobutene was selected for evaluation because of the potential for human exposure due to its large production volume and the lack of adequate data on its carcinogenic potential. The toxicity and carcinogenicity of isobutene were determined in male and female F344/N rats and B6C3F₁ mice exposed to isobutene (greater than 98% pure) by inhalation for 14 weeks or 2 years. The mutagenicity of isobutene was assessed in *Salmonella typhimurium*, and the frequency of micronuclei was determined in the peripheral blood of mice exposed by inhalation for 14 weeks.

14-WEEK STUDIES

Groups of 10 male and 10 female F344/N rats and B6C3F₁ mice were exposed to isobutene at concentrations of 0, 500, 1,000, 2,000, 4,000, or 8,000 ppm 6 hours per day, 5 days per week, for 14 weeks. Concentrations greater than 8,000 ppm isobutene were not used because of the danger of explosion. All rats and mice survived to the end of the study. The final

mean body weights and body weight gains of all exposed groups were similar to those of the chamber controls. No exposure-related gross lesions were observed in male or female rats or mice at necropsy. Microscopically, minimal hypertrophy of goblet cells lining the nasopharyngeal duct in the most caudal nose section was observed in some rats in each exposed group of males and females.

2-YEAR STUDIES

Based on the lack of significant exposure-related toxicologic effects in the 14-week rat and mouse studies, 8,000 ppm was selected as the highest exposure concentration in the 2-year studies. Concentrations of 0, 500, 2,000, and 8,000 ppm were selected for rats and mice with the 500 and 2,000 ppm selection based on published metabolic elimination rates for Sprague-Dawley rats and B6C3F₁ mice.

Rats

Groups of 50 male and 50 female F344/N rats were exposed to isobutene at concentrations of 0, 500, 2,000, or 8,000 ppm 6 hours per day, 5 days per week, for 105 weeks. Survival of exposed males and females was similar to that of the chamber controls. Mean body weights of exposed groups were generally similar to those of the chamber controls throughout the study.

2-Hydroxyisobutyric Acid —

Biomarker of Exposure

2-Hydroxyisobutyric acid (HIBA), the major urinary metabolite of isobutene, was measured in the urine of male and female rats as an indicator of isobutene exposure at 6, 12, and 18 months. The amount of HIBA excreted increased with increasing exposure concentration. However, when HIBA concentration was normalized to isobutene exposure concentration, the relative amount of HIBA excreted decreased with increasing exposure concentration, implying nonlinear kinetics.

Pathology Findings

The incidence of thyroid gland follicular cell carcinoma in male rats exposed to 8,000 ppm was increased compared to the chamber control group and exceeded the historical control range. The incidences of hyaline degeneration of the olfactory epithelium were marginally increased in exposed rats; however, the severities of hyaline degeneration increased with increasing exposure concentration in males and females.

Mice

Groups of 50 male and 50 female B6C3F₁ mice were exposed to isobutene at concentrations of 0, 500, 2,000, or 8,000 ppm 6 hours per day, 5 days per week, for 105 weeks. Survival of exposed males and females was similar to that of the chamber controls. Mean body weights of exposed mice were generally similar to those of the chamber controls throughout the study except for female mice exposed to 2,000 or 8,000 ppm, which weighed slightly less than chamber controls from about week 52 until week 92.

2-Hydroxyisobutyric Acid —

Biomarker of Exposure

HIBA was measured in the urine of male and female mice as an indicator of isobutene exposure at 6, 12, and 18 months. The amount of HIBA excreted

increased with increasing exposure concentration. However, when HIBA concentration was normalized to isobutene exposure concentration, the relative amount of HIBA excreted decreased with increasing exposure concentration, implying nonlinear kinetics.

Pathology Findings

The incidences of hyaline degeneration of the respiratory epithelium in all groups of exposed males and females were significantly greater than those in the chamber control groups. The incidences of hyaline degeneration of the olfactory epithelium in 2,000 and 8,000 ppm mice were greater than those in the chamber controls.

GENETIC TOXICOLOGY

Isobutene was not mutagenic in any of four strains of *S. typhimurium*, with or without S9 metabolic activation, and no increase in the frequency of micronucleated erythrocytes was seen in peripheral blood of male or female mice treated with isobutene by inhalation for 14 weeks.

CONCLUSIONS

Under the conditions of these 2-year inhalation studies, there was *some evidence of carcinogenic activity** of isobutene in male F344/N rats based on an increased incidence of follicular cell carcinoma of the thyroid gland. There was *no evidence of carcinogenic activity* of isobutene in female F344/N rats or male or female B6C3F₁ mice exposed to 500, 2,000, or 8,000 ppm.

Exposure to isobutene by inhalation for 2 years resulted in increased incidences and/or severities of nasal lesions including hyaline degeneration of the olfactory epithelium in male and female rats and mice and hyaline degeneration of the respiratory epithelium in male and female mice.

* Explanation of Levels of Evidence of Carcinogenic Activity is on page 8. A summary of the Technical Reports Review Subcommittee comments and the public discussion on this Technical Report appears on page 10.

Summary of the 2-Year Carcinogenesis and Genetic Toxicology Studies of Isobutene

	Male F344/N Rats	Female F344/N Rats	Male B6C3F₁ Mice	Female B6C3F₁ Mice
Concentrations in air	0, 500, 2,000, or 8,000 ppm	0, 500, 2,000, or 8,000 ppm	0, 500, 2,000, or 8,000 ppm	0, 500, 2,000, or 8,000 ppm
Body weights	Exposed groups similar to chamber control group	Exposed groups similar to chamber control group	Exposed groups similar to chamber control group	2,000 and 8,000 ppm groups slightly less than chamber control group
Survival rates	7/50, 5/50, 6/50, 8/50	23/50, 19/50, 33/50, 22/50	28/50, 32/50, 27/50, 28/50	32/50, 31/50, 39/50, 33/50
Nonneoplastic effects	<u>Nose</u> : severity of olfactory epithelial hyaline degeneration (1.3, 1.4, 2.2, 2.6)	<u>Nose</u> : severity of olfactory epithelial hyaline degeneration (1.5, 2.4, 2.8, 2.8)	<u>Nose</u> : respiratory epithelial hyaline degeneration (6/50, 19/49, 29/50, 39/48); olfactory epithelial hyaline degeneration (6/50, 7/49, 16/50, 17/48)	<u>Nose</u> : respiratory epithelial hyaline degeneration (21/47, 39/50, 41/49, 48/50); olfactory epithelial hyaline degeneration (17/47, 19/50, 24/49, 27/50)
Neoplastic effects	<u>Thyroid gland</u> : follicular cell carcinoma (1/48, 0/48, 0/48, 5/50)	None	None	None
Level of evidence of carcinogenic activity	Some evidence	No evidence	No evidence	No evidence
Genetic toxicology				
<i>Salmonella typhimurium</i> gene mutations:		Negative in strains TA97, TA98, TA100, and TA1535, with and without S9		
Micronucleated erythrocytes				
Mouse peripheral blood <i>in vivo</i> :		Negative in male and female mice		

EXPLANATION OF LEVELS OF EVIDENCE OF CARCINOGENIC ACTIVITY

The National Toxicology Program describes the results of individual experiments on a chemical agent and notes the strength of the evidence for conclusions regarding each study. Negative results, in which the study animals do not have a greater incidence of neoplasia than control animals, do not necessarily mean that a chemical is not a carcinogen, inasmuch as the experiments are conducted under a limited set of conditions. Positive results demonstrate that a chemical is carcinogenic for laboratory animals under the conditions of the study and indicate that exposure to the chemical has the potential for hazard to humans. Other organizations, such as the International Agency for Research on Cancer, assign a strength of evidence for conclusions based on an examination of all available evidence, including animal studies such as those conducted by the NTP, epidemiologic studies, and estimates of exposure. Thus, the actual determination of risk to humans from chemicals found to be carcinogenic in laboratory animals requires a wider analysis that extends beyond the purview of these studies.

Five categories of evidence of carcinogenic activity are used in the Technical Report series to summarize the strength of the evidence observed in each experiment: two categories for positive results (**clear evidence** and **some evidence**); one category for uncertain findings (**equivocal evidence**); one category for no observable effects (**no evidence**); and one category for experiments that cannot be evaluated because of major flaws (**inadequate study**). These categories of interpretative conclusions were first adopted in June 1983 and then revised in March 1986 for use in the Technical Report series to incorporate more specifically the concept of actual weight of evidence of carcinogenic activity. For each separate experiment (male rats, female rats, male mice, female mice), one of the following five categories is selected to describe the findings. These categories refer to the strength of the experimental evidence and not to potency or mechanism.

- **Clear evidence** of carcinogenic activity is demonstrated by studies that are interpreted as showing a dose-related (i) increase of malignant neoplasms, (ii) increase of a combination of malignant and benign neoplasms, or (iii) marked increase of benign neoplasms if there is an indication from this or other studies of the ability of such tumors to progress to malignancy.
- **Some evidence** of carcinogenic activity is demonstrated by studies that are interpreted as showing a chemical-related increased incidence of neoplasms (malignant, benign, or combined) in which the strength of the response is less than that required for clear evidence.
- **Equivocal evidence** of carcinogenic activity is demonstrated by studies that are interpreted as showing a marginal increase of neoplasms that may be chemical related.
- **No evidence** of carcinogenic activity is demonstrated by studies that are interpreted as showing no chemical-related increases in malignant or benign neoplasms.
- **Inadequate study** of carcinogenic activity is demonstrated by studies that, because of major qualitative or quantitative limitations, cannot be interpreted as valid for showing either the presence or absence of carcinogenic activity.

When a conclusion statement for a particular experiment is selected, consideration must be given to key factors that would extend the actual boundary of an individual category of evidence. Such consideration should allow for incorporation of scientific experience and current understanding of long-term carcinogenesis studies in laboratory animals, especially for those evaluations that may be on the borderline between two adjacent levels. These considerations should include:

- adequacy of the experimental design and conduct;
- occurrence of common versus uncommon neoplasia;
- progression (or lack thereof) from benign to malignant neoplasia as well as from preneoplastic to neoplastic lesions;
- some benign neoplasms have the capacity to regress but others (of the same morphologic type) progress. At present, it is impossible to identify the difference. Therefore, where progression is known to be a possibility, the most prudent course is to assume that benign neoplasms of those types have the potential to become malignant;
- combining benign and malignant tumor incidence known or thought to represent stages of progression in the same organ or tissue;
- latency in tumor induction;
- multiplicity in site-specific neoplasia;
- metastases;
- supporting information from proliferative lesions (hyperplasia) in the same site of neoplasia or in other experiments (same lesion in another sex or species);
- presence or absence of dose relationships;
- statistical significance of the observed tumor increase;
- concurrent control tumor incidence as well as the historical control rate and variability for a specific neoplasm;
- survival-adjusted analyses and false positive or false negative concerns;
- structure-activity correlations; and
- in some cases, genetic toxicology.

**NATIONAL TOXICOLOGY PROGRAM BOARD OF SCIENTIFIC COUNSELORS
TECHNICAL REPORTS REVIEW SUBCOMMITTEE**

The members of the Technical Reports Review Subcommittee who evaluated the draft NTP Technical Report on isobutene on 10 December 1997 are listed below. Subcommittee members serve as independent scientists, not as representatives of any institution, company, or governmental agency. In this capacity, subcommittee members have five major responsibilities in reviewing the NTP studies:

- to ascertain that all relevant literature data have been adequately cited and interpreted,
- to determine if the design and conditions of the NTP studies were appropriate,
- to ensure that the Technical Report presents the experimental results and conclusions fully and clearly,
- to judge the significance of the experimental results by scientific criteria, and
- to assess the evaluation of the evidence of carcinogenic activity and other observed toxic responses.

Gary P. Carlson, Ph.D., Chairperson
School of Health Sciences
Purdue University
West Lafayette, IN

A. John Bailer, Ph.D., Principal Reviewer
Department of Mathematics and Statistics
Miami University
Oxford, OH

Steven A. Belinsky, Ph.D., Principal Reviewer
Inhalation Toxicology Research Institute
Kirkland Air Force Base
Albuquerque, NM

James S. Bus, Ph.D.
Health and Environmental Sciences
Dow Chemical Company
Midland, MI

Linda A. Chatman, D.V.M.
Pfizer, Inc.
Groton, CT

John M. Cullen, Ph.D., V.M.D.
Department of Microbiology, Parasitology, and Pathology
College of Veterinary Medicine
North Carolina State University
Raleigh, NC

Susan M. Fischer, Ph.D.
M.D. Anderson Cancer Center
University of Texas
Smithville, TX

Thomas L. Goldsworthy, Ph.D.
Integrated Laboratory Systems
Research Triangle Park, NC

Irma Russo, M.D.
Fox Chase Cancer Center
Philadelphia, PA

Special Reviewers

Stephen S. Hecht, Ph.D.
University of Minnesota Cancer Centers
Minneapolis, MN

Jose Russo, M.D.
Fox Chase Cancer Center
Philadelphia, PA

Michele Medinsky, Ph.D., Principal Reviewer
Chemical Industry Institute of Toxicology
Research Triangle Park, NC

SUMMARY OF TECHNICAL REPORTS REVIEW SUBCOMMITTEE COMMENTS

On 10 December 1997, the draft Technical Report on the toxicology and carcinogenesis studies of isobutene received public review by the National Toxicology Program's Board of Scientific Counselors' Technical Reports Review Subcommittee. The review meeting was held at the National Institute of Environmental Health Sciences, Research Triangle Park, NC.

Dr. J.H. Roycroft, NIEHS, introduced the toxicology and carcinogenesis studies of isobutene by discussing the uses of the chemical and the rationale for study, describing the experimental design, reporting on survival and body weight effects, and commenting on compound-related neoplastic and nonneoplastic lesions in rats and mice. The proposed conclusions for the 2-year studies were *some evidence of carcinogenic activity* in male F344/N rats and *no evidence of carcinogenic activity* in female F344/N rats or male or female B6C3F₁ mice.

Dr. Bailer, a principal reviewer, agreed in principle with the proposed conclusions. He said that because there were neoplasms at only one site in the 8,000 ppm group in just one species, he would be comfortable as well with *equivocal evidence of carcinogenic activity* in male rats. Dr. Bailer said that he would like to see information on typical levels of human exposure for the potentially exposed workers. Dr. Roycroft responded that there were no human exposure data, and only a limited amount of data in the literature provides even a hint of how people might be exposed to isobutene; for example, 1% of gasoline may be isobutene. Dr. G.W. Lucier, NIEHS, reported that the NIEHS/NTP has recently established an interagency agreement with the Centers for Disease Control and Prevention, to provide

information on exposure assessment for chemicals of interest to the NTP, including those evaluated by this Subcommittee.

Dr. Medinsky, the second principal reviewer, agreed with the proposed conclusions. She complimented the NTP for the use of pharmacokinetic data. Dr. Medinsky said it would be useful to include a metabolic scheme for isobutene so that the reader could readily see where the biomarker, 3-hydroxyisobutyric acid, fits in the metabolic fate of isobutene relative to what in fact might be the toxic metabolite for this chemical. Dr. Roycroft said that a metabolic scheme could be included, that the monoepoxide is a putative metabolite, and that a metabolic modeling effort has been started on isobutene to predict some blood concentrations of the epoxide.

Dr. Belinsky, the third principal reviewer, agreed with the proposed conclusions. He thought it interesting that there was no apparent precursor lesion, hyperplasia, for the thyroid gland neoplasms. Dr. R.A. Herbert, NIEHS, commented that hyperplasia can be considered a preneoplastic lesion for thyroid gland neoplasms and that this has been seen in other studies; however, in this study, the incidences of follicular cell hyperplasia were not significantly increased.

Dr. Bailer moved that the Technical Report on isobutene be accepted with the revisions discussed and the conclusions as written for male rats, *some evidence of carcinogenic activity*, and for female rats and male and female mice, *no evidence of carcinogenic activity*. Dr. Medinsky seconded the motion, which was accepted unanimously with eight votes.

INTRODUCTION

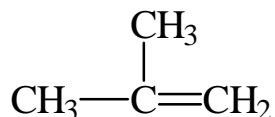

ISOBUTENE

CAS No. 115-11-7

Chemical Formula: C₄H₈ Molecular Weight: 56.10

Synonyms: γ -butylene, isobutylene, liquified petroleum gas, 2-methylpropene

CHEMICAL AND PHYSICAL PROPERTIES

Isobutene is a colorless, volatile liquid or easily liquified gas with a coal-gas odor. Isobutene has a melting point of -139°C , a boiling point of -6.9°C , a density of 0.5942, a vapor density of 2.01, and a vapor pressure of 400 mm Hg at 21.6°C . It is insoluble in water but very soluble in alcohol, benzene, ether, and sulfuric acid. Isobutene is highly flammable with a flash point of -76.11°C and an explosion limit range of 1.8% to 9.6%. Isobutene reacts vigorously with oxidizing materials and polymerizes easily (*Material Safety Data Sheet*, 1988; *Merck Index*, 1989; *Sax's*, 1992; *Hawley's*, 1993; *Patty's*, 1994).

PRODUCTION, USE, AND HUMAN EXPOSURE

Isobutene is produced during the fractionation of refinery gases or through the catalytic cracking of methyl-*t*-butyl ether. Isobutene is primarily used to produce diisobutylene, trimers, butyl rubber, and other polymers. In addition, it is used in the production of isooctane, high-octane aviation gasoline, methyl-*t*-butyl ether, and copolymer resins with butadiene and acrylonitrile (*Merck Index*, 1989; *Hawley's*, 1993; *Patty's*, 1994). It was estimated that approximately 1.3 billion pounds of isobutene were produced in the United States in 1992 (HSDB, 1997).

Although isobutene has been detected in urban atmosphere at low concentrations (*Patty's*, 1994), human exposure occurs primarily in the workplace. According to the National Occupational Exposure Survey, approximately 7,000 employees were potentially exposed to isobutene from 1981 until 1983 (NIOSH, 1990). Currently, no occupational exposure limits have been established. Although isobutene is a component of petroleum and natural gas, there are no reports of the detection of this water-insoluble, volatile gas in drinking water or wastewater.

ABSORPTION, DISTRIBUTION, METABOLISM, AND EXCRETION

Frank *et al.* (1980) detected isobutene in exhaled breath of fasted Sprague-Dawley rats given 5 g ethanol/kg body weight intraperitoneally. In addition, using a closed inhalation exposure system with Sprague-Dawley rats, Frank *et al.* (1980) determined that the isobutene elimination half-life (at an initial concentration of 5,000 ppm) was 1.3 hours.

Csanády *et al.* (1991), also using a closed inhalation exposure system, investigated the metabolism and elimination of isobutene over a 5-hour period by male Sprague-Dawley rats and B6C3F₁ mice exposed to isobutene concentrations of 100 to 12,000 ppm. The metabolism of isobutene in both species followed Michaelis-Menten kinetics. At concentrations up to

500 ppm isobutene, the metabolic elimination in rats and mice was directly proportional to exposure concentration. Maximum metabolic elimination rates (V_{\max}) were determined as 340 $\mu\text{mol/kg}$ per hour for rats and 560 $\mu\text{mol/kg}$ per hour for mice. The atmospheric concentration at which $V_{\max}/2$ was reached was 1,200 ppm for rats and 1,800 ppm for mice. The higher V_{\max} for mice can be explained by the higher microsomal monooxygenase activity in mice. These investigations also demonstrated that the epoxide 1,1-dimethyloxirane (2-methyl-1,2-epoxypropane) was formed as the primary reactive intermediate during the metabolism of isobutene in rats and was detected in exhaled air of these rats at a maximum concentration of about 0.05 ppm. Under conditions of saturation, the epoxide was only about 7% of that observed for ethene oxide (epoxide of ethene) and about 1% of that observed for 1,2-epoxy-3-butene (epoxide of 1,3-butadiene). In another study, these authors showed that isobutene was metabolized to the epoxide 1,1-dimethyloxirane with mouse liver homogenates (Cornet *et al.*, 1991), and this epoxidation was cytochrome P₄₅₀ dependent. Accumulation of the epoxide was not linear with time and reached a maximum after 20 minutes. This kinetic behavior was explained by the immediate actions of epoxide hydrolase and glutathione-S-transferase converting the epoxide to 2-methyl-1,2-propanediol and to a glutathione conjugate, respectively. These enzymes are the most important epoxide detoxification mechanisms present in liver tissue (Figure 1).

Cornet *et al.* (1995a) compared the biotransformation of isobutene to the epoxide in lung and liver homogenates taken from male Sprague-Dawley rats. Lung homogenates produced less epoxide than liver homogenates (15% to 20%) in the first 30 minutes of incubation, and lung epoxide concentrations at 1 hour were about 40% of those in the liver. Over the course of incubation, lung production of epoxide was relatively constant while that of the liver rose sharply and declined steadily after 30 minutes. The liver cytochrome P₄₅₀2E1 (CYP2E1) content was 25 times that of the lung, and glutathione-S-transferase and epoxide hydrolase activities were about 10 times greater in the liver than the lung. These factors may explain the relatively slow formation and persistence of epoxide

in the lung and the rapid formation and disappearance in the liver.

Henderson *et al.* (1993) investigated the disposition of isobutene in male Sprague-Dawley rats exposed to 0, 40, 400, or 4,000 ppm isobutene by nose-only inhalation for 2 hours. Blood levels of isobutene were linearly related to exposure concentration between 40 and 400 ppm but increased in a supralinear fashion at the highest concentration, suggesting that in the rat, metabolism of isobutene may become saturated at exposure concentrations between 400 and 4,000 ppm. These investigators also studied the total uptake, excretion patterns, and metabolism of isobutene in rats exposed to 0, 2, 40, 400, or 4,000 ppm [¹⁴C]-isobutene by inhalation for up to 6 hours. Based on the recovered dose of radioactivity, isobutene absorption was linear up to an exposure concentration of 40 ppm with approximately 8% of the inhaled dose being absorbed. However, absorption dropped to approximately 5% at 400 ppm and 2% at 4,000 ppm. The amount of isobutene metabolized was also linear up to an exposure concentration of 40 ppm but decreased at higher concentrations; over 90% of the absorbed isobutene was metabolized at concentrations up to 400 ppm, but at 4,000 ppm, approximately 20% of the absorbed dose was exhaled as unmetabolized isobutene. In addition, rat urinary metabolites of isobutene were identified as isobutenediol and 2-hydroxyisobutyric acid. Two other urinary metabolites were tentatively identified as sulfate conjugates of isobutenediol.

Peter *et al.* (1987) investigated the inhalation pharmacokinetics of isoprene, which is structurally related to isobutene, in male Wistar rats and male B6C3F₁ mice in closed desiccator jars equipped with an oxygen supply and soda lime for carbon dioxide absorption. Metabolism of isoprene was linear in rats and mice up to an atmospheric concentration of about 300 ppm. Saturation of isoprene metabolism was nearly complete at about 1,000 ppm in rats and at about 2,000 ppm in mice (Peter *et al.*, 1990). The maximal metabolic elimination rate of inhaled isoprene in mice (400 $\mu\text{mol/hr}$ per kg body weight) was about three times greater than that in rats (130 $\mu\text{mol/hr}$ per kg body weight). The half-life of isoprene was 6.8 minutes in rats and 4.4 minutes in mice.

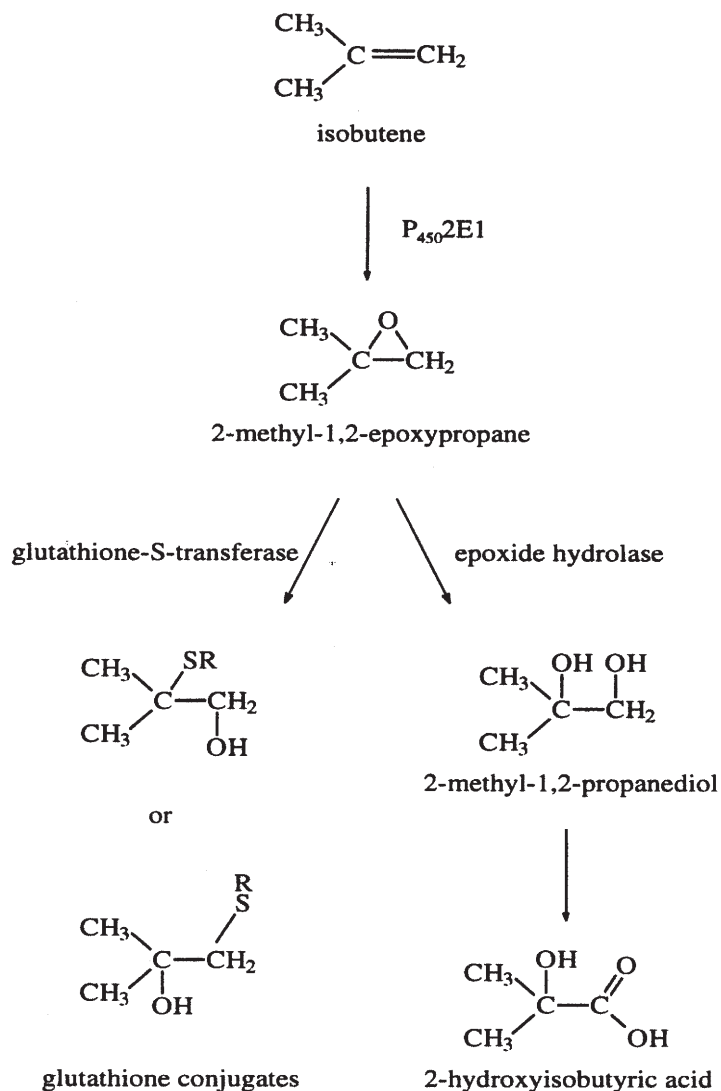

FIGURE 1
Biotransformation of Isobutene

Cornet *et al.* (1995b) investigated the *in vitro* metabolism of isobutene in human liver as well as livers from rats and mice and showed that all three formed the epoxide 2-methyl-1,2-epoxypropane in liver homogenates. However, there were quantitative differences in epoxide formation with the highest concentrations being found with the mouse tissue, followed by rat (one-half that of the mouse) and human (one-tenth that of the mouse). Conversion of isobutene to its epoxide was mediated by CYP2E1 in each of these species. The concentration of

CYP2E1 in the liver of humans, rats, and mice showed a pattern similar to that of the interspecies epoxide concentrations in that mice had the highest activity of this enzyme. Human liver, however, contained higher concentrations of the microsomal epoxide-detoxifying enzyme epoxide hydrolase, and rat liver had about one-third the concentration observed in humans. The mouse liver had a very low activity of only 5% of that in human liver but had three times as much glutathione-S-transferase activity as rat and human livers. No other studies on the absorption,

distribution, metabolism, or excretion of isobutene in humans were found in the available literature (National Library of Medicine, 1997).

Isoprene is metabolized to the epoxides 3,4-epoxy-3-methyl-1-butene and 3,4-epoxy-2-methyl-1-butene by liver microsomal cytochrome P₄₅₀-dependent monooxygenases (primarily CYP2E1) obtained from Swiss mice, Wistar rats, New Zealand rabbits, Syrian golden hamsters, and human cell lines (Del Monte *et al.*, 1985; Longo *et al.*, 1985; Gervasi and Longo, 1990; Bogaards *et al.*, 1996). The 2-methyl epoxide is produced at about 20% to 25% the rate of the 3-methyl epoxide. The epoxide intermediates of isoprene biotransformation may undergo hydrolysis to form vicinal diols (catalyzed by epoxide hydrolase), may be conjugated with glutathione (catalyzed by glutathione-S-transferase), or may be further oxidized to isoprene diepoxide (2-methyl-1,2:3,4-diepoxybutane) (Wistuba *et al.*, 1994). Both isoprene monoepoxides are further oxidized to isoprene diepoxide by rat, mouse, and human liver microsomes (Wistuba *et al.*, 1994; Bogaards *et al.*, 1996). The V_{max} value for isoprene oxidation to the 3-methyl epoxide in mice is about seven times that in rats, whereas the apparent K_m values are similar in these two species. Inhibition of epoxide hydrolase activity results in nearly similar rates of monoepoxide formation by rat, mouse, and human liver microsomes (Bogaards *et al.*, 1996). The biotransformation of isoprene is similar to that of 1,3-butadiene, which involves initial oxidation to 1,2-epoxy-3-butene followed by hydrolysis to 3-butene-1,2-diol, conjugation with glutathione, or further oxidation to diepoxybutane (Malvoisin *et al.*, 1979; Malvoisin and Roberfroid, 1982; Csanády *et al.*, 1992). As with isobutene, CYP2E1 is the major enzyme involved in the hepatic metabolism of isoprene and 1,3-butadiene.

TOXICITY

Experimental Animals

There is little information in the literature on the toxicity of isobutene in animals. The 4-hour LC₅₀ in rats is 620 g/m³ (270,000 ppm), and the 2-hour LC₅₀ in mice is 415 g/m³ (180,000 ppm) (Sax's, 1992).

Humans

No epidemiological studies or reports of health effects related to exposure to isobutene were found in the literature (National Library of Medicine, 1997).

CARCINOGENICITY

Experimental Animals

No information on the carcinogenicity of isobutene in experimental animals was found in a search of the available literature (National Library of Medicine, 1997).

Several structurally similar compounds which, like isobutene, form epoxide intermediates have been tested in rodent bioassays. There was no evidence of carcinogenicity in male or female F344/N rats or B6C3F₁ mice exposed by inhalation for 2 years to 5,000 or 10,000 ppm propylene (NTP, 1985a). However, male and female F344/N rats exposed to 400 ppm propylene oxide for 2 years had increased incidences of papillary adenoma of the nasal turbinates, and male and female B6C3F₁ mice exposed to 400 ppm had increased incidences of hemangioma or hemangiosarcoma of the nasal turbinates (NTP, 1985b). A marginal increase in the incidence of interstitial cell adenoma of the testis was observed in male F344/N rats exposed to 700, 2,200, or 7,000 ppm isoprene vapor 6 hours per day, 5 days per week for 6 months and then allowed to recover for 6 months without exposure to isoprene (Melnick *et al.*, 1994; NTP, 1995). In addition, increased incidences of neoplasms of the liver, lung, forestomach, and harderian gland were observed in male B6C3F₁ mice exposed by inhalation to 700 ppm or higher concentrations of isoprene for 6 months followed by a 6-month recovery period. Exposure-related increased incidences of liver, lung, harderian gland, and forestomach neoplasms were also observed in male B6C3F₁ mice exposed to isoprene vapor at concentrations ranging from 10 to 2,200 ppm for 4 or 8 hours per day, 5 days per week, for 20, 40, or 80 weeks followed by a recovery period until week 105 (Placke *et al.*, 1996). Increased incidences of hemangiosarcoma of the spleen and heart and of histiocytic sarcoma were also detected in exposed mice. Male and female F344/N rats exposed to 220, 700, or 7,000 ppm isoprene for 2 years had increased

incidences of mammary gland fibroadenoma (males and females) and carcinoma (males), renal tubule adenoma (males), and testicular adenoma (NTP, 1998).

Male and female Sprague-Dawley rats exposed to 1,000 or 8,000 ppm 1,3-butadiene for 2 years had dose-related neoplasms at multiple sites (Owen *et al.*, 1987). Male rats had increased incidences of pancreatic exocrine neoplasms and Leydig cell tumors of the testis. Female rats exposed to 1,3-butadiene had uterine stromal sarcomas, Zymbal's gland carcinomas, mammary gland fibroadenomas and carcinomas, and thyroid gland follicular cell neoplasms. Exposure to 6.25, 20, 62.5, 200, or 625 ppm 1,3-butadiene for 2 years produced dose-related neoplasms at multiple sites in male and female B6C3F₁ mice (NTP, 1993). Exposed mice had increased incidences of neoplasms of the hematopoietic system, brain (males), forestomach, harderian gland, heart, kidney (males), liver, lung, mammary gland (females), ovary, and preputial gland.

Humans

No epidemiology studies of isobutene in humans were found in the available literature (National Library of Medicine, 1997).

GENETIC TOXICITY

Little information is available on the mutagenicity of isobutene. Because it is a gaseous substance, modifications to standard testing protocols are necessary to achieve adequate and accurate exposure. An early abstract reported negative results in genetic toxicity tests with isobutene in several strains of *Salmonella typhimurium* and in L5178Y mouse lymphoma cells, with and without rat liver S9 metabolic activation enzymes (Staab and Sarginson, 1984). It was not stated whether experimental controls for volatility

were employed in these experiments. However, two recent investigations which employed airtight exposure systems also found no mutagenicity in *S. typhimurium* strain TA100, TA102, or TA1535 (Cornet *et al.*, 1992) at concentrations up to 50,000 ppm isobutene and no induction of micronuclei in human lymphocytes exposed to isobutene *in vitro* (Jorritsma *et al.*, 1995). Both studies, however, found positive results for each endpoint (gene mutation in *S. typhimurium* and chromosome damage in lymphocytes) when the primary metabolite of isobutene, 2-methyl-1,2-epoxypropane, was tested in the absence of metabolic activation enzymes. Cornet *et al.* (1992) reported that no bacterial toxicity was noted in any of the three tester strains used to determine isobutene mutagenicity, but toxicity was noted in each strain at 75,000 ppm, the highest concentration of 2-methyl-1,2-epoxypropane tested. Further investigations by this same laboratory of the mutagenic activity of 2-methyl-1,2-epoxypropane in *S. typhimurium* strains TA100 and TA1535 also showed significant increases in mutations at concentrations as low as 250 ppm without S9 (Castelain *et al.*, 1993). Mutagenic activity with S9 required approximately a fourfold increase in the concentration of 2-methyl-1,2-epoxypropane. In addition, an earlier report of a mutagenicity test with 2-methyl-1,2-epoxypropane showed a doubling of the mutation rate in *Klebsiella pneumoniae* exposed to 5 or 10 mmol of 2-methyl-1,2-epoxypropane/L (Voogd *et al.*, 1981).

STUDY RATIONALE

Isobutene was nominated by the National Cancer Institute for study based on the potential for human exposure to the chemical due to its large production volume, the lack of test data, and structural relationship to the known animal carcinogens isoprene and 1,3-butadiene. Inhalation was chosen as the route of exposure because human exposure occurs primarily via this route.

MATERIALS AND METHODS

PROCUREMENT AND CHARACTERIZATION OF ISOBUTENE

Isobutene was manufactured by Exxon, Inc. (Baytown, TX), supplied by Specialty Gas Concepts (La Porte, TX), and shipped through Norco (Kennewick, WA) in two lots (SGC051091ECA and SGC020594ECA). Lot SGC051091ECA was used during the 14-week and 2-year studies, and lot SGC020594ECA was used during the 2-year studies. Identity, purity, and stability analyses were conducted by the study laboratory, Battelle Pacific Northwest Laboratories (Richland, WA). Reports on analyses performed in support of the isobutene studies are on file at the National Institute of Environmental Health Sciences.

The chemical, a colorless vapor at room temperature, was identified as isobutene by infrared and nuclear magnetic resonance spectroscopy. The purity of each lot was determined by gas chromatography relative to a reference standard with a declared purity of 99.9% purchased from Matheson Gas Products (East Rutherford, NJ). Major peak comparisons by two systems indicated a relative purity of 100.0% by one system and 100.6% by the second system for lot SGC051091ECA relative to the reference standard. For lot SGC020594ECA, gas chromatographic peak comparison indicated a relative purity of greater than 98.4% by each system. The overall purity of lot SGC051091ECA was determined to be greater than 99%, and the overall purity of lot SGC020594ECA was greater than 98%.

Additional analyses of each lot were performed with gas chromatography/mass spectrometry to identify and quantify the impurities indicated by the manufacturer or by gas chromatography. The mass spectrum pattern of the major peak was consistent with isobutene. The following impurities were detected for lot SGC051091ECA: propane/propene, 42 ppm; isobutane, 140 ppm; 1,3-butadiene, 6 ppm; *trans*-2-butene, 213 ppm; and *cis*-2-butene, 286 ppm. Butane and *n*-butene coeluted with the major peak and were not quantified. Lot SGC020594ECA contained

an estimated 11 ppm propane/propene, 339 ppm isobutane, 15 ppm *trans*-2-butene, 11 ppm *cis*-2-butene, and no 1,3-butadiene. Samples from each cylinder of each lot of isobutene were analyzed for 1,3-butadiene before the cylinder was used for exposure by gas chromatography/mass spectrometry with the same gas chromatography system. All cylinders used in the 14-week studies contained less than 50 ppm 1,3-butadiene, well within the set limit of 100 ppm; the maximum concentration detected in cylinders used in the 2-year studies was 15 ppm. Cylinders used in the 14-week studies were also screened individually for other impurities; results indicated less than 1% impurities by peak area, with no impurity present greater than 0.1%.

In a 4-day pilot study, the stability of isobutene was monitored in grab-bag samples taken from the distribution manifold at the beginning and the end of 6-hour generation periods until approximately 94% of the cylinder was exhausted. The results from samples taken over 8 test generation days showed no significant enhancement of any volatile impurities, and no additional impurities were detected with relative areas of 0.1% or greater relative to isobutene. Based on these results, approximately 90% of the contents of each cylinder were used during the 14-week and 2-year studies.

During the studies, the bulk chemical was stored in its original shipping cylinders at approximately 22° C. Stability was monitored throughout the studies by the study laboratory with gas chromatography. No degradation of the bulk chemical was detected.

VAPOR GENERATION AND EXPOSURE SYSTEM

Isobutene was distributed under regulated pressure. The cylinder in use and a backup cylinder were connected in parallel to the exposure system. Warm circulating-water blankets surrounding the cylinders provided additional heat to replace the heat lost due to isobutene vaporization. The gas passed through a

filter via a main on/off pneumatic valve and then was distributed by a manifold to five (14-week studies) or six (2-year studies) pairs of metering valves with corresponding flow meters. Isobutene was delivered to each exposure chamber through these flow meters via three-way solenoid valves located at the chamber end of the vapor delivery line. Isobutene vapor was diluted with conditioned air as it was injected into the chamber inlet duct. The study laboratory designed the inhalation exposure chamber (Harford Systems Division, Aberdeen, MD) so that uniform vapor concentrations could be maintained throughout the chamber with the catch pans in place.

VAPOR CONCENTRATION MONITORING

Chamber concentrations of isobutene were monitored by an on-line gas chromatograph. Samples were drawn from each chamber approximately every 20 minutes during exposures by a computer-controlled, 12-port, stream select valve. The on-line gas chromatograph was calibrated by direct analysis of volumetrically prepared gas bag standards during the 14-week studies and by using validated, commercially prepared standards during the 2-year studies. An on-line standard of isobutene in nitrogen was used to monitor instrument drift. Vapor concentration uniformity in the exposure chambers without animals present was measured using the on-line gas chromatograph before each of the studies began. Chamber concentration uniformity was maintained throughout the studies. Summaries of the chamber concentrations for the 14-week and 2-year studies are presented in Tables J1 and J2.

CHAMBER ATMOSPHERE CHARACTERIZATION

The times for the exposure concentration to build up to 90% of the final exposure concentration (T_{90}) and to decay to 10% of the exposure concentration (T_{10}) were measured with and without animals present in the chambers. In the 14-week and 2-year studies, with and without animals in the chambers, T_{90} values ranged from 8 to 15 minutes, and T_{10} values ranged from 6 to 12 minutes. The T_{90} value selected for all studies was 12 minutes.

Studies of isobutene degradation and monitoring for impurities were conducted throughout the studies by

gas chromatography. No significant degradation of isobutene or enhancement of impurities was observed during the studies.

14-WEEK STUDIES

The 14-week studies were conducted to evaluate the cumulative toxic effects of repeated exposure to isobutene and to determine the appropriate exposure concentrations to be used in the 2-year studies.

Male and female F344/N rats and B6C3F₁ mice were obtained from Taconic Farms (Germantown, NY). On receipt, the rats and mice were 5 weeks old. Animals were quarantined for 11 to 13 days and were 6 weeks old on the first day of the studies. Before initiation of the studies, five male and five female rats and mice were randomly selected for parasite evaluation and gross observation for evidence of disease. At the end of the studies, serologic analyses were performed on five male and five female sentinel rats and control mice using the protocols of the NTP Sentinel Animal Program.

Groups of 10 male and 10 female rats and mice were exposed to isobutene by inhalation at concentrations of 0, 500, 1,000, 2,000, 4,000, or 8,000 ppm for 6 hours plus T_{90} (12 minutes) per day, 5 days per week, for 14 weeks; 8,000 ppm was chosen as the highest exposure concentration that could be generated safely. It is less than 50% of the lower explosion limit of isobutene (approximately 18,000 ppm; *Patty's*, 1994). Groups of 10 male and 10 female special study rats were exposed to the same concentrations for 23 days. Feed was available *ad libitum* except during exposure periods. Water was available *ad libitum*. Rats and mice were housed individually. Clinical findings were recorded weekly for rats and mice. The animals were weighed initially, weekly, and at the end of the studies. Details of the study design and animal maintenance are summarized in Table 1.

Clinical pathology studies were performed on 10 male and 10 female special study rats per group on days 3 and 23 and on all core study rats at study termination. At all time points, rats were anesthetized with CO₂ and blood was drawn from the retroorbital sinus. Blood for hematology determinations was placed in tubes containing potassium EDTA as the anti-coagulant. Blood for clinical chemistry analyses was

placed in tubes without anticoagulant, allowed to clot at room temperature, and centrifuged, and the serum was separated. The hematology and clinical chemistry endpoints evaluated are listed in Table 1.

Hematology determinations, including erythrocyte, leukocyte, and platelet counts, hemoglobin concentration, hematocrit, mean cell volume, mean cell hemoglobin, and mean cell hemoglobin concentration, were performed with an Ortho ELT-8/ds 9000 hematology analyzer (Ortho Diagnostic Systems, Westwood, MA). Manual microhematocrit determinations were made using a Damon/IEC microcapillary centrifuge and reader (International Equipment Company, Needham Heights, MA). Leukocyte differential and nucleated erythrocyte counts and morphologic evaluation of blood cells were determined by light microscopic examination of blood films stained with a modified Wright's stain using a Wescor 7100 Aerospray slide stainer (Wescor, Logan, UT). Smears made from preparations of equal volumes of new methylene blue and whole blood and incubated for at least 20 minutes at room temperature were examined microscopically, using the Miller disc method, for the quantitative determination of reticulocytes. Clinical chemistry endpoints were determined on a Cobas Fara chemistry analyzer (Roche Diagnostic Systems, Inc., Montclair, NJ) and an Abbott VP bichromatic chemistry instrument (Abbott Laboratories, Irving, TX) using reagents and methods obtained from the manufacturers.

At the end of the 14-week studies, samples were collected for sperm motility and vaginal cytology evaluations on core study rats and mice exposed to 0, 2,000, 4,000, or 8,000 ppm. The parameters evaluated are listed in Table 1. Methods used were those described in the NTP's sperm morphology and vaginal cytology evaluations protocol (NTP, 1987). For 12 consecutive days prior to scheduled terminal sacrifice, the vaginal vaults of the females were moistened with saline, if necessary, and samples of vaginal fluid and cells were stained. Relative numbers of leukocytes, nucleated epithelial cells, and large squamous epithelial cells were determined and used to ascertain estrous cycle stage (i.e., diestrus, proestrus, estrus, and metestrus). Male animals were evaluated for sperm count and motility. The left testis and left epididymis were isolated and weighed. The tail of the epididymis (cauda epididymis) was then removed from the epididymal body (corpus epididymis) and

weighed. Test yolk (rats) or modified Tyrode's buffer (mice) was applied to slides and a small incision was made at the distal border of the cauda epididymis. The sperm effluxing from the incision were dispersed in the buffer on the slides, and the numbers of motile and nonmotile spermatozoa were counted for five fields per slide by two observers. Following completion of sperm motility estimates, each left cauda epididymis was placed in buffered saline solution. Caudae were finely minced, and the tissue was incubated in the saline solution and then heat fixed at 65° C. Sperm density was then determined microscopically with the aid of a hemacytometer. To quantify spermatogenesis, the testicular spermatid head count was determined by removing the tunica albuginea and homogenizing the left testis in phosphate-buffered saline containing 10% dimethyl sulfoxide. Homogenization-resistant spermatid nuclei were counted with a hemacytometer.

A necropsy was performed on all animals. The heart, liver, lung, right kidney, right testis, and thymus were weighed. Tissues for microscopic examination were fixed and preserved in 10% neutral buffered formalin, processed and trimmed, embedded in paraffin, sectioned to a thickness of 5 to 6 µm, and stained with hematoxylin and eosin. A complete histopathologic examination was performed on chamber control and 8,000 ppm rats and mice, and the nose was examined to the no-effect level in rats. Table 1 lists the tissues and organs routinely examined.

2-YEAR STUDIES

Study Design

Groups of 50 male and 50 female rats and mice were exposed to isobutene by inhalation at concentrations of 0, 500, 2,000, or 8,000 ppm 6 hours plus T₉₀ (12 minutes) per day, 5 days per week, for 105 weeks.

Source and Specification of Animals

Male and female F344/N rats and B6C3F₁ mice were obtained from Taconic Farms (Germantown, NY) for use in the 2-year studies. Rats and mice were quarantined for 14 days before the beginning of the studies. Five male and five female rats and mice were randomly selected for parasite evaluation and gross observation of disease. Rats and mice were approximately 6 weeks old at the beginning of the studies.

The health of the animals was monitored during the studies according to the protocols of the NTP Sentinel Animal Program (Appendix L).

Animal Maintenance

Rats and mice were housed individually. Feed was available *ad libitum* except during exposure and urine collection periods. Water was available *ad libitum*. Cage batteries were rotated weekly. Further details of animal maintenance are given in Table 1. Information on feed composition and contaminants is provided in Appendix K.

Clinical Examinations and Pathology

All animals were observed twice daily, 7 days per week. Clinical findings were recorded initially, at weeks 5, 6, and 9 (mice), every 4 weeks from week 4 through week 91 (rats) or from week 13 through week 92 (mice), and every 2 weeks until the end of the study. Body weights were recorded initially, weekly through week 12 (rats) or week 13 (mice), every 4 weeks from week 15 (rats) or week 16 (mice) through week 91 (rats) or week 92 (mice), and every 2 weeks until the end of the study.

Five male and five female rats and mice from the control groups and 10 male and 10 female rats and mice from each exposed group were evaluated at 6, 12, and 18 months for determination of 2-hydroxyisobutyric acid (HIBA) in urine. Rats and mice were housed individually in metabolism cages for 16 hours after exposure while urine samples were collected over ice, after which samples were weighed and stored at -20°C in glass vials until analysis. All urine samples were analyzed for HIBA and creatinine and were prepared for analysis by combining a weighed aliquot of urine with sulfuric acid/sodium sulfate solution containing an internal standard (chloroacetic acid). This mixture was aspirated through a C_{18} -bonded solid-phase extraction tube and then extracted with ethyl acetate. Diazomethane was added to the ethyl acetate extract to derivatize HIBA and chloroacetic acid to their respective methyl esters. Samples were analyzed using an HP-5890 Series II gas chromatograph equipped with an HP-7673 autosampler and an HP-5971 mass selective detector (Hewlett-Packard Company, Wilmington, DE). Separation of analytes was achieved using a deactivated, fused silica capillary column (J&W Scientific DB-1701) with on-column injection and a helium carrier gas at 3 psi constant pressure. Detec-

tion and quantitation limits were calculated using analysis results from spiked urine standards. The parameters measured are listed in Table 1.

A complete necropsy and microscopic examination were performed on all rats and mice. At necropsy, all organs and tissues were examined for grossly visible lesions, and all major tissues were fixed and preserved in 10% neutral buffered formalin, processed and trimmed, embedded in paraffin, sectioned to a thickness of 5 to 6 μm , and stained with hematoxylin and eosin for microscopic examination. For all paired organs (i.e., adrenal gland, kidney, ovary), samples from each organ were examined. Tissues examined microscopically are listed in Table 1.

Microscopic evaluations were completed by the study laboratory pathologist, and the pathology data were entered into the Toxicology Data Management System. The slides, paraffin blocks, and residual wet tissues were sent to the NTP Archives for inventory, slide/block match, and wet tissue audit. The slides, individual animal data records, and pathology tables were evaluated by an independent quality assessment laboratory. The individual animal records and tables were compared for accuracy, the slide and tissue counts were verified, and the histotechnique was evaluated. For the 2-year rat studies, a quality assessment pathologist evaluated slides from all tumors and all potential target organs which included the nose and lung of males and females; the heart, liver, spleen, and thyroid gland of males; the ovaries of females; and all neoplasms in all organs. For the 2-year mouse studies, a quality assessment pathologist evaluated slides from all tumors and all potential target organs which included the nose of males and females, the thyroid gland of females, and all neoplasms in all organs. In addition, the epididymis was reviewed when the diagnosis of sperm granuloma occurred.

The quality assessment report and the reviewed slides were submitted to the NTP Pathology Working Group (PWG) chairperson, who reviewed the selected tissues and addressed any inconsistencies in the diagnoses made by the laboratory and quality assessment pathologists. Representative histopathology slides containing examples of lesions related to chemical administration, examples of disagreements in diagnoses between the laboratory and quality assessment pathologist, or lesions of general interest were presented by the chairperson to the PWG for review. The PWG

consisted of the quality assessment pathologist and other pathologists experienced in rodent toxicologic pathology. This group examined the tissues without any knowledge of dose groups or previously rendered diagnoses. When the PWG consensus differed from the opinion of the laboratory pathologist, the diagnosis was changed. Final diagnoses for reviewed lesions represent a consensus between the laboratory pathol-

ogist, reviewing pathologist(s), and the PWG. Details of these review procedures have been described, in part, by Maronpot and Boorman (1982) and Boorman *et al.* (1985). For subsequent analyses of the pathology data, the decision of whether to evaluate the diagnosed lesions for each tissue type separately or combined was generally based on the guidelines of McConnell *et al.* (1986).

TABLE 1
Experimental Design and Materials and Methods in the Inhalation Studies of Isobutene

14-Week Studies	2-Year Studies
Study Laboratory Battelle Pacific Northwest Laboratories (Richland, WA)	Battelle Pacific Northwest Laboratories (Richland, WA)
Strain and Species Rats: F344/N Mice: B6C3F ₁	Rats: F344/N Mice: B6C3F ₁
Animal Source Taconic Farms (Germantown, NY)	Taconic Farms (Germantown, NY)
Time Held Before Studies Rats: 11 days (males) or 12 days (females) Mice: 12 days (males) or 13 days (females)	14 days
Average Age When Studies Began 6 weeks	6 weeks
Date of First Exposure Rats: 20 January 1992 (males) 21 January 1992 (females) Mice: 21 January 1992 (males) 22 January 1992 (females)	Rats: 11 March 1993 Mice: 4 March 1993
Duration of Exposure 6 hours plus T ₉₀ (12 minutes) per day, 5 days per week, for 14 weeks	6 hours plus T ₉₀ (12 minutes) per day, 5 days per week, for 105 weeks
Date of Last Exposure Rats: 20 April 1992 (males) 21 April 1992 (females) Mice: 22 April 1992 (males) 23 April 1992 (females)	Rats: 10 March 1995 Mice: 3 March 1995
Necropsy Dates Rats: 21 April 1992 (males) 22 April 1992 (females) Mice: 23 April 1992 (males) 24 April 1992 (females)	Rats: 13-15 March 1995 Mice: 6-9 March 1995
Average Age at Necropsy 20 weeks	Rats: 111 weeks Mice: 111-112 weeks
Size of Study Groups 10 males and 10 females	50 males and 50 females
Method of Distribution Animals were distributed randomly into groups of approximately equal initial mean body weights.	Same as 14-week studies
Animals per Cage 1	1
Method of Animal Identification Tail tattoo	Tail tattoo

TABLE 1
Experimental Design and Materials and Methods in the Inhalation Studies of Isobutene

14-Week Studies	2-Year Studies
Diet NIH-07 open formula pelleted diet (Zeigler Brothers, Inc., Gardners, PA), available <i>ad libitum</i> except during exposure periods, changed weekly	NIH-07 open formula pelleted diet (Zeigler Brothers, Inc., Gardners, PA), available <i>ad libitum</i> except during exposure and urine collection periods, changed weekly
Water Softened tap water (Richland municipal supply) via automatic watering system (Edstrom Industries, Waterford, WI), available <i>ad libitum</i>	Same as 14-week studies
Cages Stainless steel wire bottom (Hazleton Systems, Inc., Aberdeen, MD), changed weekly	Same as 14-week studies
Chamber Air Supply Filters Charcoal filter Single HEPA (Northland Filter Systems International, Mechanicville, NY), checked twice per year Purafil® (Environmental Systems, Lynnwood, MA)	Charcoal filter Single HEPA (Flanders Filters, Inc., San Rafael, CA), checked twice per year Purafil® (Environmental Systems, Lynnwood, MA)
Chambers Stainless steel (Lab Products, Inc., Harford Systems Division, Aberdeen, MD), changed weekly	Same as 14-week studies
Chamber Environment Temperature: 23.7°-24.4° C Relative humidity: 53%-58% Room fluorescent light: 12 hours/day Chamber air changes: 15/hour	Temperature: 23.9°-24.2° C Relative humidity: 53%-58% Room fluorescent light: 12 hours/day Chamber air changes: 15/hour
Exposure Concentrations 0, 500, 1,000, 2,000, 4,000, or 8,000 ppm	0, 500, 2,000, or 8,000 ppm
Type and Frequency of Observation Observed twice daily; animals were weighed initially, weekly, and at the end of the studies; clinical findings were recorded weekly.	Observed twice daily; clinical findings were recorded initially, at weeks 5, 6, and 9 (mice), every 4 weeks from week 4 through week 91 (rats) or from week 13 through week 92 (mice), and every 2 weeks until the end of the studies; animals were weighed initially, weekly through week 12 (rats) or week 13 (mice), every 4 weeks from week 15 (rats) or week 16 (mice) through week 91 (rats) or week 92 (mice) and every 2 weeks until the end of the studies.
Method of Sacrifice 70% CO ₂	Same as 14-week studies
Necropsy Necropsy was performed on all animals. Organs weighed were the heart, liver, lung, right kidney, right testis, and thymus.	Necropsy was performed on all animals.

TABLE 1
Experimental Design and Materials and Methods in the Inhalation Studies of Isobutene

14-Week Studies	2-Year Studies
<p>Clinical Pathology Blood was collected from the retroorbital plexus of 10 male and 10 female special study rats at day 3 and day 23 and of core study rats at terminal sacrifice for hematology and clinical chemistry analyses.</p> <p>Hematology: hematocrit (automated and manual); hemoglobin concentration; erythrocyte, reticulocyte, nucleated erythrocyte, and platelet counts; mean cell volume; mean cell hemoglobin; mean cell hemoglobin concentration; leukocyte count and differentials</p> <p>Clinical chemistry: urea nitrogen, creatinine, serum glucose, total protein, albumin, globulin, A/G ratio, alanine aminotransferase, alkaline phosphatase, creatine kinase, sorbitol dehydrogenase, bile acids</p> <p>Histopathology Complete histopathology was performed on all core study chamber control and 8,000 ppm rats and mice. In addition to gross lesions and tissue masses, the following tissues were examined: adrenal gland, bone with marrow, brain, clitoral gland, esophagus, gallbladder (mice), heart, large intestine (cecum, colon, rectum), small intestine (duodenum, jejunum, ileum), kidney, larynx, liver, lung, lymph nodes (mandibular, mesenteric, bronchial, mediastinal), mammary gland (with adjacent skin), nose, ovary, pancreas, parathyroid gland, pituitary gland, preputial gland, prostate gland, salivary gland, spleen, stomach (forestomach and glandular), testes (with epididymis and seminal vesicle), thymus, thyroid gland, trachea, urinary bladder, and uterus. In addition, the nose of all male and female rats was examined.</p> <p>Sperm Motility and Vaginal Cytology At the end of the studies, sperm samples were collected from all male animals in the 0, 2,000, 4,000, and 8,000 ppm exposure groups for sperm motility evaluations. The following parameters were evaluated: spermatid heads per testis, spermatid count, and epididymal spermatozoal concentration and motility. The left cauda epididymis, epididymis, and testis were weighed. Vaginal samples were collected for up to 12 consecutive days prior to the end of the studies from all females exposed to 0, 2,000, 4,000, and 8,000 ppm for vaginal cytology evaluations. The following parameters were evaluated: estrous cycle length and relative frequency of estrous stages.</p> <p>2-Hydroxyisobutyric Acid — Biomarker of Exposure None</p>	<p>None</p> <p>Complete histopathology was performed on all rats and mice. In addition to gross lesions and tissue masses, the following tissues were examined: adrenal gland, bone with marrow, brain, clitoral gland, esophagus, gallbladder (mice), heart, large intestine (cecum, colon, rectum), small intestine (duodenum, jejunum, ileum), kidney, larynx, liver, lung, lymph nodes (mandibular, mesenteric, bronchial, mediastinal), mammary gland (with adjacent skin), nose, ovary, pancreatic islets, parathyroid gland, pituitary gland, preputial gland, prostate gland, salivary gland, spleen, stomach (forestomach and glandular), testes (with epididymis and seminal vesicle), thymus, thyroid gland, trachea, urinary bladder, and uterus.</p> <p>None</p> <p>Five male and five female rats and mice from the chamber control groups and 10 male and 10 female rats and mice from each exposed group were evaluated at 6, 12, and 18 months for determination of HIBA in urine. Rats and mice were housed individually in metabolism cages for 16 hours after exposure while urine samples were collected over ice. Parameters evaluated included urinary excretion, creatinine, and HIBA.</p>

STATISTICAL METHODS

Survival Analyses

The probability of survival was estimated by the product-limit procedure of Kaplan and Meier (1958) and is presented in the form of graphs. Animals found dead of other than natural causes were censored from the survival analyses; animals dying from natural causes were not censored. Statistical analyses for possible dose-related effects on survival used Cox's (1972) method for testing two groups for equality and Tarone's (1975) life table test to identify dose-related trends. All reported P values for the survival analyses are two sided.

Calculation of Incidence

The incidences of neoplasms or nonneoplastic lesions are presented in Tables A1, A5, B1, B4, C1, C4, D1, and D4 as the number of animals bearing such lesions at a specific anatomic site and the number of animals with that site examined microscopically. For calculation of statistical significance, the incidences of most neoplasms (Tables A3, B3, C3, and D3) and all nonneoplastic lesions are given as the numbers of animals affected at each site examined microscopically. However, when macroscopic examination was required to detect neoplasms in certain tissues (e.g., harderian gland, intestine, mammary gland, and skin) before microscopic evaluation, or when neoplasms had multiple potential sites of occurrence (e.g., leukemia or lymphoma), the denominators consist of the number of animals on which a necropsy was performed. Tables A3, B3, C3, and D3 also give the survival-adjusted neoplasm rate for each group and each site-specific neoplasm. This survival-adjusted rate (based on the Poly-3 method described below) accounts for differential mortality by assigning a reduced risk of neoplasm, proportional to the third power of the fraction of time on study, to animals that do not reach terminal sacrifice.

Analysis of Neoplasm and Nonneoplastic Lesion Incidences

The Poly-k test (Bailer and Portier, 1988; Portier and Bailer, 1989; Piegorsch and Bailer, 1997) was used to assess neoplasm and nonneoplastic lesion prevalence. This test is a survival-adjusted quantal-response procedure that modifies the Cochran-Armitage linear trend test to take survival differences into account. More specifically, this method modifies the denom-

inator in the quantal estimate of lesion incidence to approximate more closely the total number of animal years at risk. For analysis of a given site, each animal is assigned a risk weight. This value is one if the animal had a lesion at that site or if it survived until terminal sacrifice; if the animal died prior to terminal sacrifice and did not have a lesion at that site, its risk weight is the fraction of the entire study time that it survived, raised to the kth power.

This method yields a lesion prevalence rate that depends only upon the choice of a shape parameter for a Weibull hazard function describing cumulative lesion incidence over time (Bailer and Portier, 1988). Unless otherwise specified, a value of $k=3$ was used in the analysis of site-specific lesions. This value was recommended by Bailer and Portier (1988) following an evaluation of neoplasm onset time distributions for a variety of site-specific neoplasms in control F344 rats and B6C3F₁ mice (Portier *et al.*, 1986). Bailer and Portier (1988) showed that the Poly-3 test gave valid results if the true value of k was anywhere in the range from 1 to 5. A further advantage of the Poly-3 method is that it does not require lesion lethality assumptions. Variation introduced by the use of risk weights, which reflect differential mortality, was accommodated by adjusting the variance of the Poly-3 statistic as recommended by Bieler and Williams (1993).

Tests of significance included pairwise comparisons of each exposed group with controls and a test for an overall exposure-related trend. Continuity-corrected tests were used in the analysis of lesion incidence, and reported P values are one sided. Values of P greater than 0.5 are presented as 1-P with the letter N added to indicate a lower incidence or negative trend in neoplasm occurrence relative to the control group (e.g., $P=0.99$ is presented as $P=0.01N$).

Analysis of Continuous Variables

Two approaches were employed to assess the significance of pairwise comparisons between exposed and control groups in the analysis of continuous variables. Organ and body weight data, which have approximately normal distributions, were analyzed with the parametric multiple comparison procedures of Dunnett (1955) and Williams (1971, 1972). Hematology, clinical chemistry, urinalysis, spermatid, and

epididymal spermatozoal data, which have typically skewed distributions, were analyzed using the non-parametric multiple comparison methods of Shirley (1977) and Dunn (1964). Jonckheere's test (Jonckheere, 1954) was used to assess the significance of the dose-related trends and to determine whether a trend-sensitive test (Williams' or Shirley's test) was more appropriate for pairwise comparisons than a test that does not assume a monotonic dose-related trend (Dunnett's or Dunn's test). Prior to statistical analysis, extreme values identified by the outlier test of Dixon and Massey (1951) were examined by NTP personnel, and implausible values were eliminated from the analysis. Average severity values were analyzed for significance with the Mann-Whitney U test (Hollander and Wolfe, 1973). Because vaginal cytology data are proportions (the proportion of the observation period that an animal was in a given estrous stage), an arcsine transformation was used to bring the data into closer conformance with a normality assumption. Treatment effects were investigated by applying a multivariate analysis of variance (Morrison, 1976) to the transformed data to test for simultaneous equality of measurements across exposure concentrations.

Historical Control Data

Although the concurrent control group is always the first and most appropriate control group used for evaluation, historical control data can be helpful in the overall assessment of neoplasm incidence in certain instances. Consequently, neoplasm incidences from the NTP historical control database, which is updated yearly, are included in the NTP reports for neoplasms appearing to show compound-related effects.

QUALITY ASSURANCE METHODS

The 14-week and 2-year studies were conducted in compliance with Food and Drug Administration Good Laboratory Practice Regulations (21 CFR, Part 58). In addition, as records from the 2-year studies were submitted to the NTP Archives, these studies were audited retrospectively by an independent quality assurance contractor. Separate audits covered completeness and accuracy of the pathology data, pathology specimens, final pathology tables, and a draft of this NTP Technical Report. Audit procedures and findings are presented in the reports and are on file at NIEHS. The audit findings were reviewed and assessed by NTP staff, so all comments had been

resolved or were otherwise addressed during the preparation of this Technical Report.

GENETIC TOXICOLOGY

The genetic toxicity of isobutene was assessed by testing the ability of the chemical to induce mutations in various strains of *Salmonella typhimurium* and increases in the frequency of micronucleated erythrocytes in peripheral blood of mice. The protocols for these studies and the results are given in Appendix E.

The genetic toxicity studies of isobutene are part of a larger effort by the NTP to develop a database that would permit the evaluation of carcinogenicity in experimental animals from the molecular structure and the effects of the chemical in short-term *in vitro* and *in vivo* genetic toxicity tests. These genetic toxicity tests were originally developed to study mechanisms of chemical-induced DNA damage and to predict carcinogenicity in animals, based on the electrophilicity theory of chemical mutagenesis and the somatic mutation theory of cancer (Miller and Miller, 1977; Straus, 1981; Crawford, 1985).

There is a strong correlation between a chemical's potential electrophilicity (structural alert to DNA reactivity), mutagenicity in *Salmonella*, and carcinogenicity in rodents. The combination of electrophilicity and *Salmonella* mutagenicity is highly correlated with the induction of carcinogenicity in rats and mice and/or at multiple tissue sites (Ashby and Tennant, 1991). Other *in vitro* genetic toxicity tests correlate less well with rodent carcinogenicity (Tennant *et al.*, 1987; Zeiger *et al.*, 1990), although these other tests can provide information on the types of DNA and chromosome effects that can be induced by the chemical being investigated. Data from NTP studies show that a positive response in *Salmonella* is the most predictive *in vitro* test for rodent carcinogenicity (89% of the *Salmonella* mutagens are rodent carcinogens), and that there is no complementarity among the *in vitro* genetic toxicity tests. That is, no battery of tests that included the *Salmonella* test improved the predictivity of the *Salmonella* test alone.

The predictivity for carcinogenicity of a positive response in bone marrow chromosome aberration or micronucleus tests appears to be less than the *Salmonella* test (Shelby *et al.*, 1993; Shelby and Witt, 1995). Positive responses in long-term

peripheral blood micronucleus tests have not been formally evaluated for their predictivity for rodent carcinogenicity. But, because of the theoretical and observed associations between induced genetic

damage and adverse effects in somatic and germ cells, the determination of *in vivo* genetic effects is important to the overall understanding of the risks associated with exposure to a particular chemical.

RESULTS

RATS

14-WEEK STUDY

All male and female rats survived to the end of the study (Table 2). The final mean body weights and body weight gains of all exposed groups of males and females were similar to those of the chamber control groups. There were no clinical findings or effects on

hematologic or clinical chemistry indices attributed to isobutene exposure (Table F1). There were no biologically significant effects on male or female reproductive endpoints as a result of exposure to isobutene (Tables H1 and H2).

TABLE 2
Survival and Body Weights of Rats in the 14-Week Inhalation Study of Isobutene

Concentration (ppm)	Survival ^a	Mean Body Weight ^b (g)			Final Weight Relative to Controls (%)
		Initial	Final	Change	
Male					
0	10/10	139 ± 5	354 ± 7	215 ± 8	
500	10/10	138 ± 5	361 ± 6	223 ± 7	102
1,000	10/10	140 ± 6	359 ± 7	219 ± 8	101
2,000	10/10	141 ± 4	357 ± 6	216 ± 6	101
4,000	10/10	142 ± 7	359 ± 7	217 ± 7	101
8,000	10/10	145 ± 7	356 ± 6	211 ± 9	101
Female					
0	10/10	117 ± 3	205 ± 4	88 ± 4	
500	10/10	115 ± 3	200 ± 2	85 ± 3	98
1,000	10/10	119 ± 2	212 ± 4	93 ± 5	103
2,000	10/10	116 ± 2	211 ± 4	95 ± 4	103
4,000	10/10	116 ± 2	205 ± 4	88 ± 4	100
8,000	10/10	120 ± 3	213 ± 5	92 ± 4	104

^a Number of animals surviving at 14 weeks/number initially in group

^b Weights and weight changes are given as mean ± standard error. Differences from the chamber control group were not significant by Williams' or Dunnett's test.

The absolute right kidney weights of 4,000 and 8,000 ppm males and the relative right kidney weights of all exposed groups of males were greater than those of the chamber controls; however, the differences were no greater than 10% and 8%, respectively (Table G1). The absolute liver weights of females exposed to 1,000 ppm and above and the relative liver

weights of all exposed groups of females were greater (up to 20%) than those of the chamber controls; however, the increases in absolute and relative liver weights did not occur in a concentration-related manner. There were no histopathologic effects supporting increased kidney or liver weights as a result of isobutene exposure.

No exposure-related gross lesions were observed in male or female rats at necropsy. Microscopically, minimal hypertrophy of goblet cells lining the nasopharyngeal duct in the most caudal nose section was observed in some rats in each exposed group of males and females (males: chamber control, 0/10; 500 ppm, 4/10; 1,000 ppm, 7/10; 2,000 ppm, 9/10; 4,000 ppm, 8/10; 8,000 ppm, 9/10; females: 0/10, 4/10, 8/10, 8/10, 7/10, 10/10).

Exposure Concentration Selection Rationale: Based on the lack of significant exposure-related toxicologic effects, 8,000 ppm was selected as the highest exposure concentration in the 2-year study. A higher concentration could not be used because of the danger of explosion. The 2-year study exposure concentrations of 0, 500, 2,000, and 8,000 ppm were based on published metabolic elimination rates for Sprague-Dawley rats and B6C3F₁ mice (Csanády *et al.*, 1991). These rates indicated that 500 ppm would be within the linear range for metabolic elimination, 2,000 ppm would be near the linear range, and 8,000 ppm would be out of the linear range.

2-YEAR STUDY**Survival**

Estimates of 2-year survival probabilities for male and female rats are shown in Table 3 and in the Kaplan-Meier survival curves (Figure 2). Survival of exposed males and females was similar to that of the chamber controls.

Body Weights and Clinical Findings

Mean body weights of exposed male and female rats were generally similar to those of the chamber controls throughout the study (Figure 3 and Tables 4 and 5). There were no clinical findings attributed to isobutene exposure.

TABLE 3
Survival of Rats in the 2-Year Inhalation Study of Isobutene

	Chamber Control	500 ppm	2,000 ppm	8,000 ppm
Male				
Animals initially in study	50	50	50	50
Moribund	39	40	37	41
Natural deaths	4	5	7	1
Animals surviving to study termination	7	5	6	8
Percent probability of survival at end of study ^a	14	10	12	16
Mean survival (days) ^b	630	610	612	649
Survival analysis ^c	P= 0.282N	P= 0.346	P= 0.450	P= 0.718N
Female				
Animals initially in study	50	50	50	50
Accidental death ^d	0	1	0	0
Moribund	21	25	15	23
Natural deaths	6	5	2	5
Animals surviving to study termination	23	19	33	22
Percent probability of survival at end of study	46	39	66	44
Mean survival (days)	667	635	696	658
Survival analysis	P= 0.926	P= 0.469	P= 0.069N	P= 0.909

^a Kaplan-Meier determinations

^b Mean of all deaths (uncensored, censored, and terminal sacrifice)

^c The result of the life table trend test (Tarone, 1975) is in the chamber control column, and the results of the life table pairwise comparisons (Cox, 1972) with the chamber controls are in the exposed group columns. A negative trend or lower mortality in an exposure group is indicated by N.

^d Censored from survival analyses

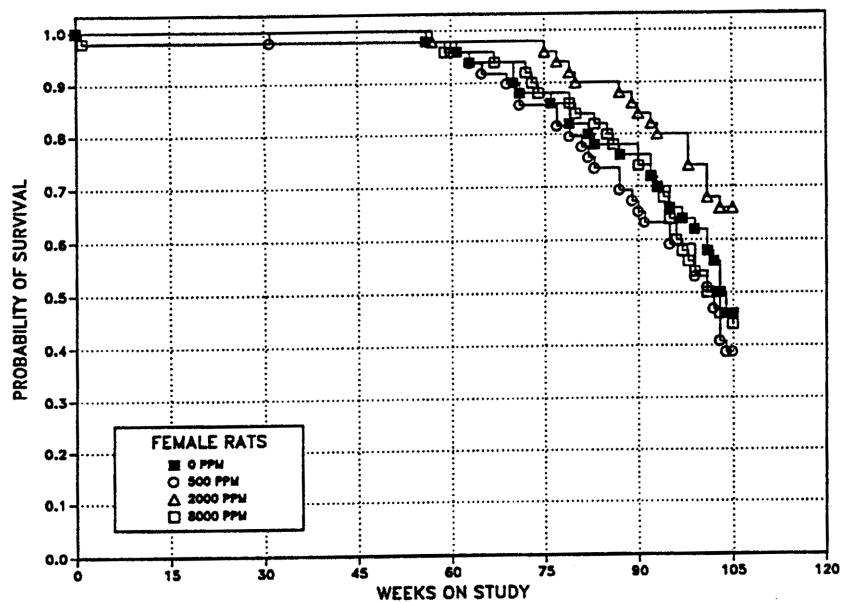
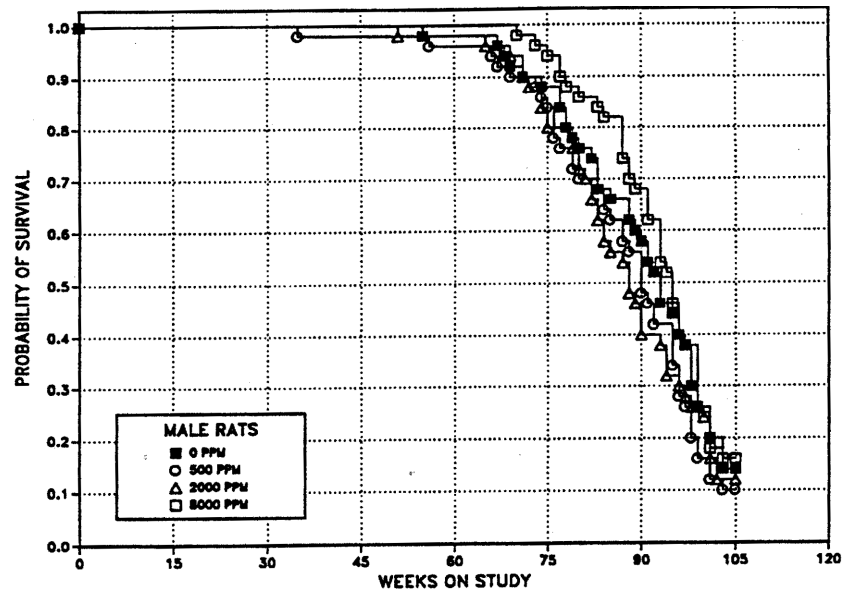

FIGURE 2
Kaplan-Meier Survival Curves for Male and Female Rats
Exposed to Isobutene by Inhalation for 2 Years

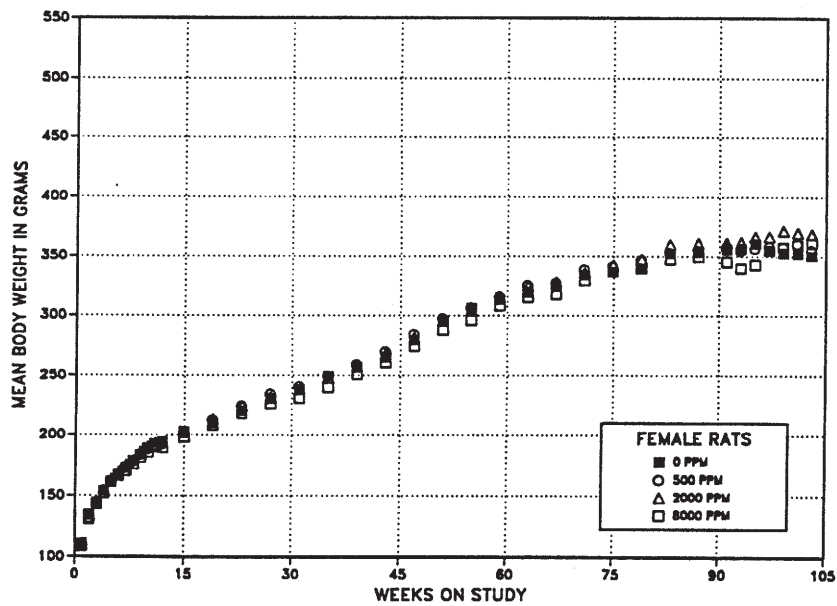
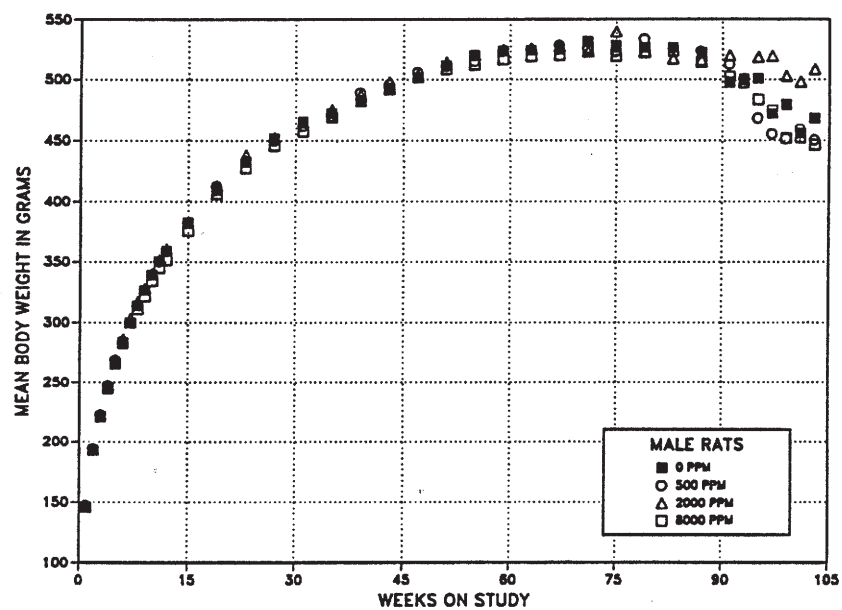

FIGURE 3
Growth Curves for Male and Female Rats Exposed
to Isobutene by Inhalation for 2 Years

TABLE 4
Mean Body Weights and Survival of Male Rats in the 2-Year Inhalation Study of Isobutene

Weeks on Study	Chamber Control		500 ppm			2,000 ppm			8,000 ppm		
	Av. Wt. (g)	No. of Survivors	Av. Wt. (g)	Wt. (% of controls)	No. of Survivors	Av. Wt. (g)	Wt. (% of controls)	No. of Survivors	Av. Wt. (g)	Wt. (% of controls)	No. of Survivors
1	147	50	148	101	50	147	100	50	146	99	50
2	192	50	194	101	50	193	100	50	193	100	50
3	220	50	223	101	50	223	101	50	221	101	50
4	244	50	247	101	50	248	101	50	245	100	50
5	265	50	269	101	50	269	102	50	266	100	50
6	282	50	285	101	50	287	102	50	283	100	50
7	300	50	300	100	50	303	101	50	300	100	50
8	314	50	315	100	50	317	101	50	311	99	50
9	326	50	327	100	50	328	101	50	322	99	50
10	339	50	339	100	50	340	100	50	335	99	50
11	350	50	350	100	50	352	100	50	345	99	50
12	359	50	359	100	50	361	101	50	351	98	50
15	383	50	383	100	50	383	100	50	376	98	50
19	409	50	413	101	50	413	101	50	406	99	50
23	433	50	433	100	50	438	101	50	428	99	50
27	452	50	450	100	50	453	100	50	446	99	50
31	465	50	462	99	50	465	100	50	457	98	50
35	472	50	470	100	50	475	101	50	469	99	50
39	483	50	489	101	49	487	101	50	483	100	50
43	493	50	496	101	49	498	101	50	492	100	50
47	501	50	506	101	49	504	101	50	501	100	50
51	511	50	511	100	49	514	101	49	509	100	50
55	520	49	515	99	49	520	100	49	512	99	50
59	524	49	523	100	48	525	100	49	516	99	50
63	524	49	525	100	48	526	100	49	519	99	50
67	525	48	529	101	47	528	101	48	520	99	50
71	531	45	526	99	45	523	98	47	525	99	49
75	528	44	523	99	42	540	102	40	519	98	48
79	526	40	533	101	37	523	99	39	522	99	44
83	526	36	526	100	34	517	98	32	523	100	42
87	522	33	523	100	29	516	99	27	514	98	38
91	498	28	512	103	23	520	104	20	502	101	33
93	500	24	500	100	21	500	100	20	498	100	29
95	500	22	468	94	19	519	104	16	484	97	26
97	472	20	455	96	14	519	110	15	475	101	20
99	479	14	452	94	10	503	105	13	452	94	14
101	456	12	459	101	7	498	109	10	452	99	9
103	468	8	450	96	5	508	109	6	446	95	9
Mean for weeks											
1-13	278		280	101		281	101		277	100	
14-52	460		461	100		463	101		457	99	
53-103	506		501	99		518	102		499	99	

TABLE 5
Mean Body Weights and Survival of Female Rats in the 2-Year Inhalation Study of Isobutene

Weeks on Study	Chamber Control		500 ppm			2,000 ppm			8,000 ppm		
	Av. Wt. (g)	No. of Survivors	Av. Wt. (g)	Wt. (% of controls)	No. of Survivors	Av. Wt. (g)	Wt. (% of controls)	No. of Survivors	Av. Wt. (g)	Wt. (% of controls)	No. of Survivors
1	111	50	110	100	50	111	100	50	109	98	50
2	134	50	132	98	50	135	100	50	131	98	49
3	144	50	143	99	49	146	101	50	143	99	49
4	154	50	152	99	49	155	101	50	152	99	49
5	162	50	162	100	49	164	102	50	161	100	49
6	167	50	167	100	49	170	101	50	166	99	49
7	172	50	173	101	49	175	102	50	170	99	49
8	178	50	177	100	49	179	100	50	175	99	49
9	183	50	183	100	49	186	102	50	181	99	49
10	189	50	188	99	49	190	101	50	185	98	49
11	193	50	191	99	49	194	101	50	190	98	49
12	194	50	192	99	49	194	100	50	189	97	49
15	203	50	202	100	49	202	100	50	198	98	49
19	210	50	213	101	49	213	102	50	208	99	49
23	220	50	225	102	49	224	102	50	218	99	49
27	231	50	234	102	49	232	101	50	226	98	49
31	238	50	241	101	49	238	100	50	231	97	49
35	249	50	250	100	48	248	99	50	240	96	49
39	257	50	259	101	48	259	101	50	251	98	49
43	265	50	270	102	48	268	101	50	261	98	49
47	279	50	284	102	48	282	101	50	274	98	49
51	295	50	298	101	48	296	100	50	288	98	49
55	306	50	307	100	48	305	100	50	296	97	49
59	313	49	316	101	48	315	100	50	308	98	48
63	320	48	325	102	47	325	102	49	316	99	48
67	324	47	327	101	45	328	101	49	318	98	48
71	334	45	339	102	43	337	101	49	329	99	47
75	337	44	342	101	42	343	102	48	337	100	44
79	340	43	347	102	39	347	102	47	340	100	43
83	352	40	353	100	37	360	102	45	347	99	42
87	353	39	355	101	35	361	102	44	350	99	39
91	356	38	358	101	31	362	102	42	346	97	37
93	356	35	355	100	31	362	102	41	340	96	36
95	361	34	357	99	30	367	102	40	343	95	33
97	355	33	358	101	29	367	103	40	355	100	29
99	353	31	358	101	27	372	105	37	358	101	28
101	352	29	361	102	25	370	105	35	360	102	26
103	350	27	355	101	20	369	105	34	361	103	25
Mean for weeks											
1-13	165		164	99		167	101		163	99	
14-52	245		248	101		246	100		240	98	
53-103	341		345	101		349	102		338	99	

***2-Hydroxyisobutyric Acid —
Biomarker of Exposure***

2-Hydroxyisobutyric acid (HIBA), the major urinary metabolite of isobutene, was measured in the urine of male and female rats as an indicator of isobutene exposure at 6, 12, and 18 months (Table I1). The amount of HIBA excreted increased with increasing exposure concentration (Figures 4 and 5). However, when HIBA concentration was normalized to iso-

butene exposure concentration, the relative amount of HIBA excreted decreased as exposure concentrations increased (Figures 6 and 7). This was true at all three collection intervals for males and females. Exposure to isobutene had no effect on the quantity of urine or the amount of creatinine excreted.

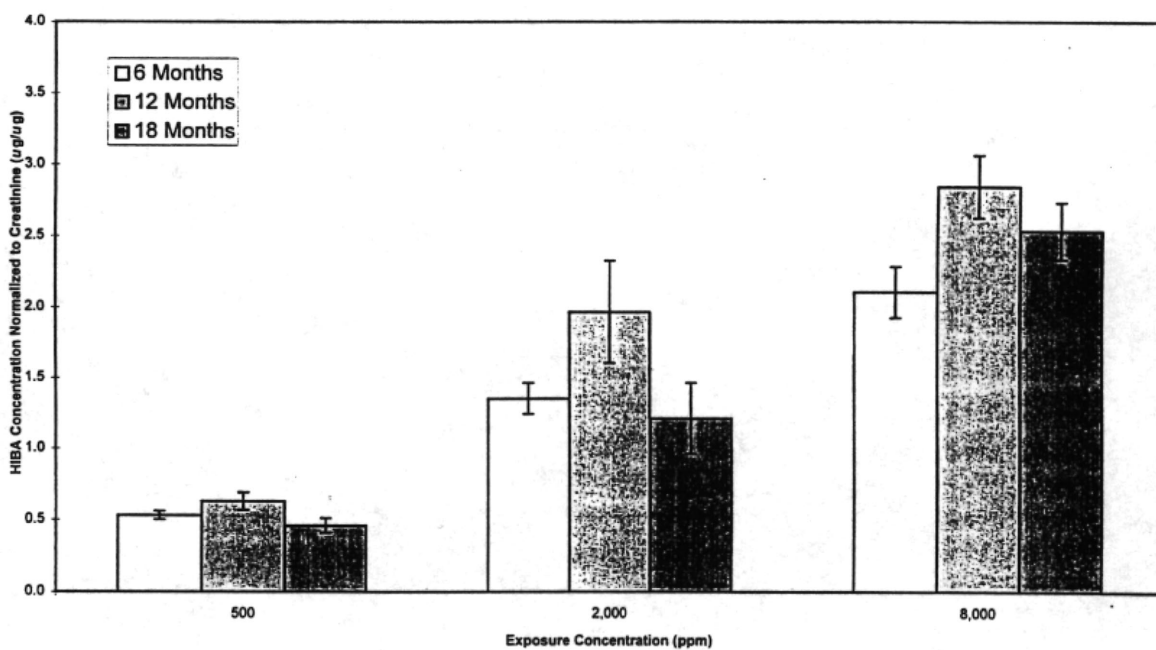

FIGURE 4
 Mean (\pm Standard Deviation) 2-Hydroxyisobutyric Acid Concentration Normalized to Creatinine for Male Rats in the 2-Year Inhalation Study of Isobutene

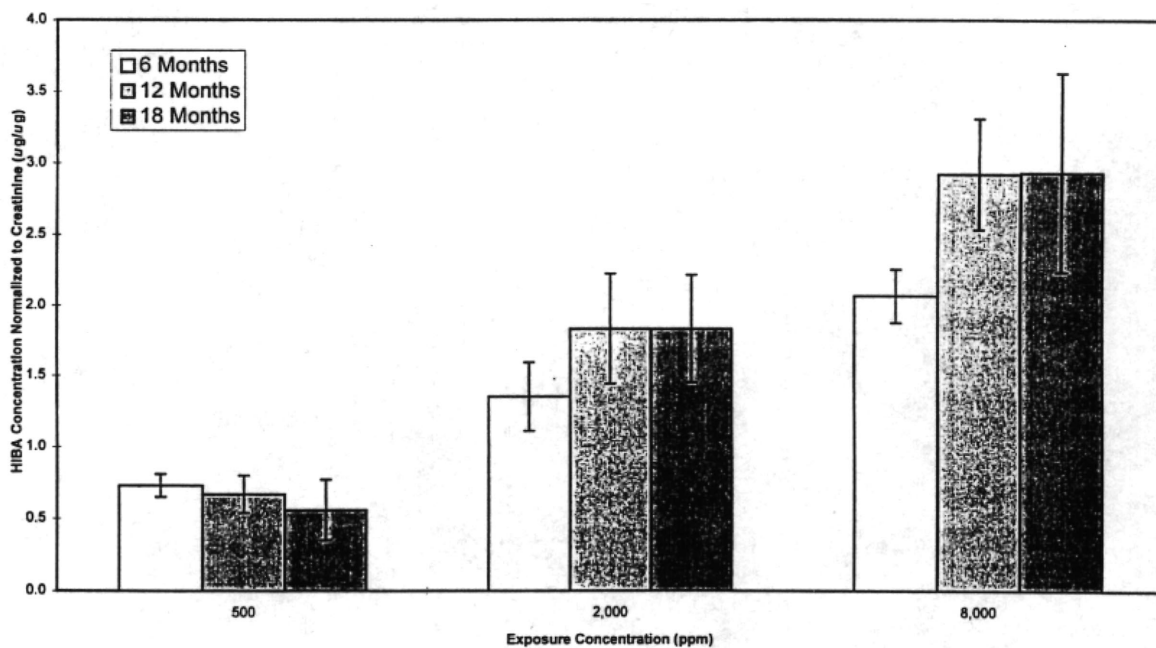

FIGURE 5
 Mean (\pm Standard Deviation) 2-Hydroxyisobutyric Acid Concentration Normalized to Creatinine for Female Rats in the 2-Year Inhalation Study of Isobutene

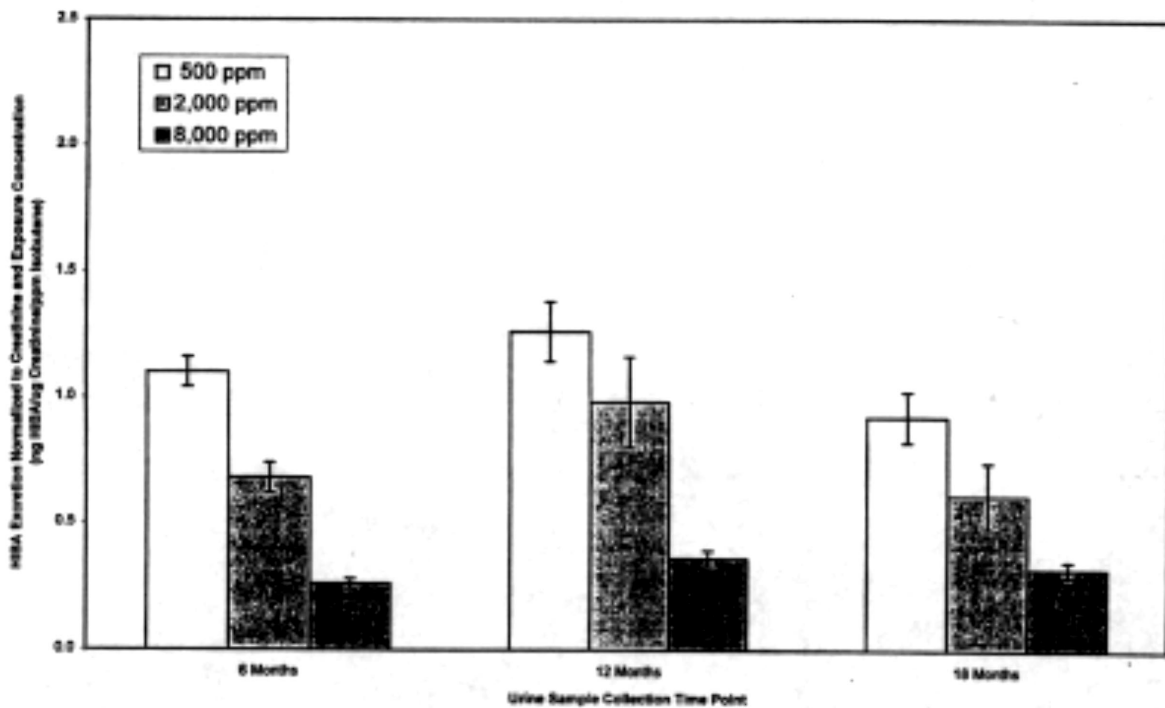

FIGURE 6
 Mean (\pm Standard Deviation) 2-Hydroxyisobutyric Excretion Normalized to Creatinine and Exposure Concentration for Male Rats in the 2-Year Inhalation Study of Isobutene

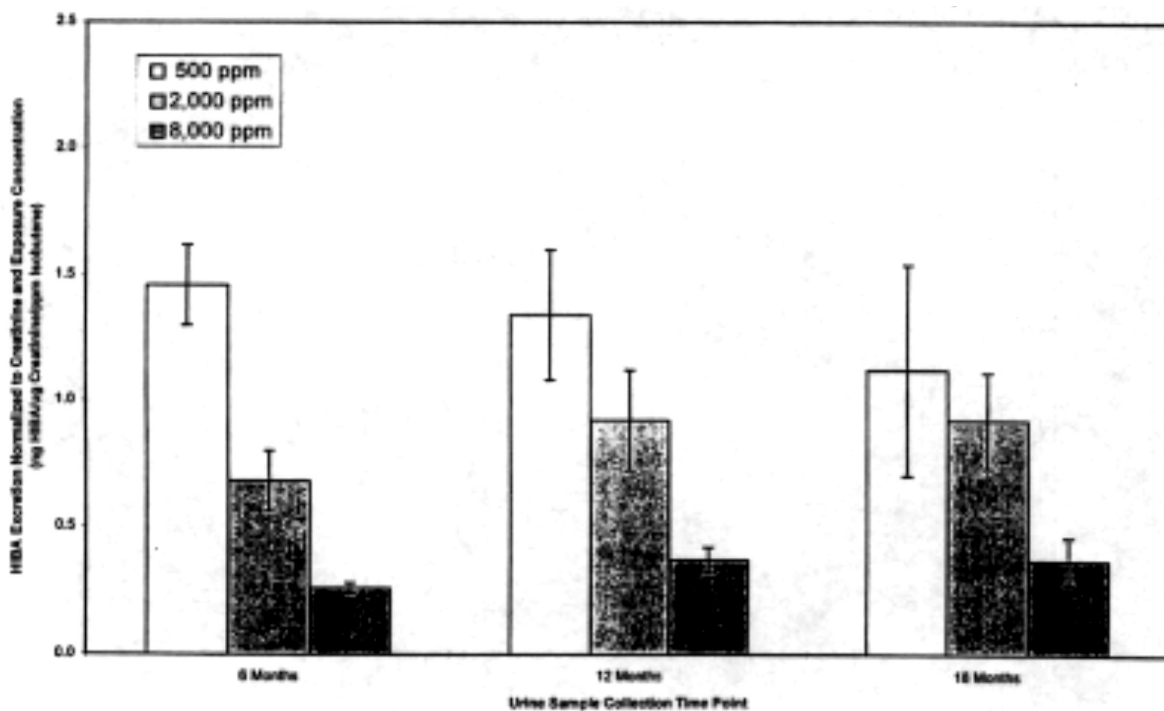

FIGURE 7
 Mean (\pm Standard Deviation) 2-Hydroxyisobutyric Excretion Normalized to Creatinine and Exposure Concentration for Female Rats in the 2-Year Inhalation Study of Isobutene

Pathology and Statistical Analyses

This section describes the statistically significant or biologically noteworthy changes in the incidences of neoplasms and/or nonneoplastic lesions of the thyroid gland, nose, and heart and of mononuclear cell leukemia. Summaries of the incidences of neoplasms and nonneoplastic lesions, individual animal tumor diagnoses, statistical analyses of primary neoplasms that occurred with an incidence of at least 5% in at least one animal group, and historical incidences for the neoplasms mentioned in this section are presented in Appendix A for male rats and Appendix B for female rats.

Thyroid Gland: The incidence of follicular cell carcinoma in male rats exposed to 8,000 ppm was greater than that in the chamber control group and exceeded the historical control range (Tables 6, A3, and A4). The histomorphology of the carcinomas that were observed in chamber control and exposed rats was similar to the morphologic spectrum typical of spontaneously developing follicular cell carcinomas. Histologically, all were unilateral, well-delineated, medium-sized to large (0.3 to 1.3 cm) nodular masses that partially or completely replaced the affected lobe (Plates 1 through 6). There was clear focal to extensive invasion of the capsule and, in some cases, the immediately adjacent tissue (Plates 3 through 5). The carcinomas consisted of follicular, papillary, or solid patterns or variable combinations of these patterns and were surrounded by a prominent scirrhous reaction. Carcinomas with predominantly follicular or papillary patterns had relatively uniform cells and often multiple prominent, cystic, colloid-filled follicles and spaces (Plate 7). The neoplastic cells in carcinomas having solid areas or that were predominantly solid were more anaplastic than the cells in follicular or papillary patterns and were characterized by moderate variation in cellular size and shape (pleomorphism) and low to high numbers of mitotic figures (Plates 8 and 9). One carcinoma had neoplastic cell emboli within the vasculature and had metastasized to the lungs (Plates 10 and 11). Concurrent increases in the incidences of follicular cell adenoma and hyperplasia did not occur in male rats (Tables 6, A1, and A5), nor were the incidences of proliferative lesions of the thyroid gland increased in female rats (follicular cell hyperplasia: chamber control, 0/50; 500 ppm, 2/50; 2,000 ppm, 0/49; 8,000 ppm, 0/49; follicular cell carcinoma: 1/50, 0/50, 0/49, 0/49; Tables B1 and B4).

Nose: Although the incidences of hyaline degeneration of the olfactory epithelium in males and females were only slightly increased in exposed rats (males: 43/49, 45/49, 46/50, 49/49; females: 44/50, 47/50, 48/50, 47/49; Tables A5 and B4), the severities of hyaline degeneration increased with increasing exposure concentration (males: 1.3, 1.4, 2.2, 2.6; females: 1.5, 2.4, 2.8, 2.8). Hyaline degeneration was characterized by accumulation of variably sized, brightly eosinophilic globules in the cytoplasm of sustentacular cells in the ethmoid turbinate olfactory epithelium. In inhalation studies, hyaline degeneration is a commonly observed change in the epithelium of the nasal cavity, the incidence and severity of which may increase with increasing exposure concentration. The accumulation of these protein globules is considered a nonspecific adaptive response to prolonged inhalation of irritant material and has no adverse effect on affected animals.

Heart: The incidences of atrial thrombosis in males occurred with a positive trend. The incidence of this lesion in 8,000 ppm males was significantly greater than that in the chamber control group (0/50, 1/50, 3/50, 6/50; Table A5). Histologically, thrombi occurred in the left atrium and were somewhat varied in size and character with no common unifying morphologic features. Atrial thrombosis is a common spontaneous lesion observed at a low incidence in chronic rat studies, and an incidence of zero in the controls is unusual. The marginal increase observed in this study was not considered to be related to isobutene exposure.

Mononuclear Cell Leukemia: The incidences of mononuclear cell leukemia in male rats occurred with a positive trend (21/50, 21/50, 20/50, 31/50; Table A3). This marginal increase most likely represents a spurious occurrence. The incidence in the 8,000 ppm group was not significant, was well within the historical control range [520/905 (57.5% ± 9.4%), range, 34%-70%], and is not considered to be related to isobutene exposure. In addition, the incidences of mononuclear cell leukemia in exposed female rats were similar to that in the chamber controls (18/50, 16/50, 22/50, 17/50; Table B3).

TABLE 6
Incidences of Follicular Cell Neoplasms and Nonneoplastic Lesions of the Thyroid Gland in Male Rats
in the 2-Year Inhalation Study of Isobutene

	Chamber Control	500 ppm	2,000 ppm	8,000 ppm
Number Examined Microscopically	48	48	48	50
Hyperplasia ^a	0	2 (3.0) ^b	0	1 (4.0)
Carcinoma ^c				
Overall rate ^d	1/48 (2%)	0/48 (0%)	0/48 (0%)	5/50 (10%)
Adjusted rate ^e	3.0%	0.0%	0.0%	13.5%
Terminal rate ^f	0/7 (0%)	0/5 (0%)	0/6 (0%)	0/8 (0%)
First incidence (days)	661	— ^h	—	618
Poly-3 test ^g	P= 0.004	P= 0.519N	P= 0.521N	P= 0.125

^a Number of animals with lesion

^b Average severity grade of lesions in affected animals: 1= minimal, 2= mild, 3= moderate, 4= marked

^c Historical incidence for 2-year inhalation studies with chamber control groups (mean ± standard deviation): adenoma: 7/892 (0.8% ± 1.2%), range 0%-4%; carcinoma: 9/892 (1.0% ± 1.2%), range 0%-4%; adenoma or carcinoma: 16/892 (1.8% ± 1.7%), range 0%-6%

^d Number of animals with neoplasm per number of animals with thyroid gland examined microscopically

^e Poly-3 estimated neoplasm incidence after adjustment for intercurrent mortality

^f Observed incidence at terminal kill

^g Beneath the chamber control incidence is the P value associated with the trend test. Beneath the exposed group incidence are the P values corresponding to the pairwise comparisons between the chamber controls and that exposed group. The Poly-3 test accounts for differential mortality in animals that do not reach terminal sacrifice. A lower incidence in an exposure group is indicated by **N**.

^h Not applicable; no neoplasms in animal group

MICE

14-WEEK STUDY

All male and female mice survived to the end of the study (Table 7). The final mean body weights and body weight gains of all exposed groups of males and females were similar to those of the chamber controls.

There were no clinical findings or biologically significant effects on male or female reproductive endpoints attributed to isobutene exposure (Tables H3 and H4).

TABLE 7
Survival and Body Weights of Mice in the 14-Week Inhalation Study of Isobutene

Concentration (ppm)	Survival ^a	Mean Body Weight ^b (g)			Final Weight Relative to Controls (%)
		Initial	Final	Change	
Male					
0	10/10	25.0 ± 0.4	35.9 ± 1.2	10.9 ± 1.0	
500	10/10	24.8 ± 0.3	36.9 ± 0.8	12.1 ± 0.6	103
1,000	10/10	25.2 ± 0.4	38.5 ± 0.8	13.3 ± 0.5	107
2,000	10/10	25.0 ± 0.3	35.9 ± 0.9	10.9 ± 0.8	100
4,000	10/10	25.2 ± 0.4	36.1 ± 0.6	10.9 ± 0.5	101
8,000	10/10	25.0 ± 0.3	35.7 ± 0.9	10.8 ± 0.7	99
Female					
0	10/10	19.8 ± 0.2	30.6 ± 0.6	10.8 ± 0.5	
500	10/10	20.0 ± 0.3	30.6 ± 0.7	10.7 ± 0.7	100
1,000	10/10	20.1 ± 0.3	32.7 ± 1.1	12.6 ± 0.9	107
2,000	10/10	20.1 ± 0.2	31.9 ± 0.9	11.8 ± 0.8	104
4,000	10/10	20.2 ± 0.3	31.5 ± 1.0	11.3 ± 0.9	103
8,000	10/10	20.1 ± 0.1	30.8 ± 0.6	10.7 ± 0.6	101

^a Number of animals surviving at 14 weeks/number initially in group

^b Weights and weight changes are given as mean ± standard error. Differences from the chamber control group were not significant by Williams' or Dunnett's test.

The absolute and relative right kidney weights of 8,000 ppm males were greater (approximately 11%) than those of the chamber controls (Table G2). The absolute and relative right kidney weights of all groups of exposed females were greater (up to 18%) than those of the chamber controls, but, in general, were not exposure concentration related. There were no lesions detected grossly at necropsy or microscopically that supported these increases.

Exposure Concentration Selection Rationale: Based on the lack of significant exposure-related toxicologic

effects, 8,000 ppm was selected as the highest exposure concentration in the 2-year study. A higher concentration of isobutene could not be used because of the danger of explosion. The 2-year study exposure concentrations of 0, 500, 2,000, and 8,000 ppm were based on published metabolic elimination rates for Sprague-Dawley rats and B6C3F₁ mice (Csanády *et al.*, 1991). These rates indicated that 500 ppm would be within the linear range for metabolic elimination, 2,000 ppm would be near the linear range, and 8,000 ppm would be out of the linear range.

2-YEAR STUDY

Survival

Estimates of 2-year survival probabilities for male and female mice are shown in Table 8 and in the Kaplan-Meier survival curves (Figure 8). Survival of exposed males and females was similar to that of the chamber controls.

Body Weights and Clinical Findings

Mean body weights of exposed male mice and 500 ppm females were generally similar to those of the chamber controls throughout the study; however, the mean body weights of 2,000 and 8,000 ppm females were slightly less than those of the chamber controls from about week 52 to week 92 (Tables 9 and 10 and Figure 9). There were no clinical findings attributed to isobutene exposure.

TABLE 8
Survival of Mice in the 2-Year Inhalation Study of Isobutene

	Chamber Control	500 ppm	2,000 ppm	8,000 ppm
Male				
Animals initially in study	50	50	50	50
Moribund	16	9	20	13
Natural deaths	6	9	3	9
Animals surviving to study termination	28	32	27	28
Percent probability of survival at end of study ^a	56	64	54	56
Mean survival (days) ^b	676	692	663	656
Survival analysis ^c	P= 0.642	P= 0.488N	P= 0.835	P= 0.977
Female				
Animals initially in study	50	50	50	50
Moribund	13	16	6	13
Natural deaths	5	3	5	4
Animals surviving to study termination	32	31	39	33
Percent probability of survival at end of study	64	62	78	66
Mean survival (days)	681	695	708	710
Survival analysis	P= 0.802N	P= 1.000	P= 0.182N	P= 0.820N

^a Kaplan-Meier determinations

^b Mean of all deaths (uncensored, censored, and terminal sacrifice)

^c The result of the life table trend test (Tarone, 1975) is in the chamber control column, and the results of the life table pairwise comparisons (Cox, 1972) with the chamber controls are in the exposed group columns. A negative trend or lower mortality in an exposure group is indicated by N.

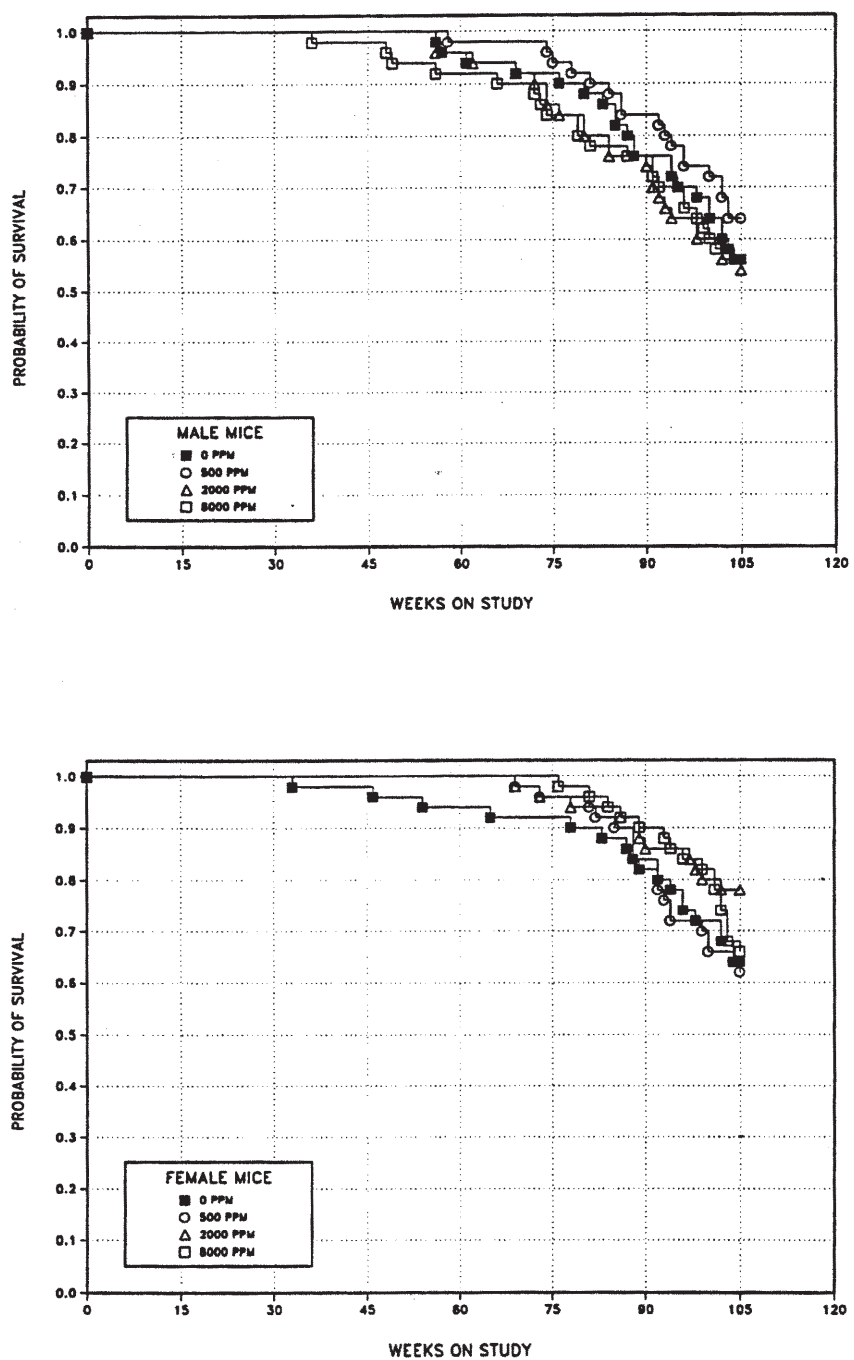

FIGURE 8
Kaplan-Meier Survival Curves for Male and Female
Mice Exposed to Isobutene by Inhalation for 2 Years

TABLE 9
Mean Body Weights and Survival of Male Mice in the 2-Year Inhalation Study of Isobutene

Weeks on Study	Chamber Control		500 ppm			2,000 ppm			8,000 ppm		
	Av. Wt. (g)	No. of Survivors	Av. Wt. (g)	Wt. (% of controls)	No. of Survivors	Av. Wt. (g)	Wt. (% of controls)	No. of Survivors	Av. Wt. (g)	Wt. (% of controls)	No. of Survivors
1	25.6	50	25.9	101	50	25.6	100	50	25.5	100	50
2	27.5	50	27.6	100	50	27.4	100	50	27.4	100	50
3	28.4	50	28.5	100	50	28.3	100	50	28.2	99	50
4	29.3	50	29.3	100	50	29.1	99	50	29.2	100	50
5	30.2	50	30.1	100	50	29.9	99	50	29.9	99	50
6	30.8	50	30.6	99	50	30.2	98	50	30.4	99	50
7	31.3	50	31.1	99	50	30.7	98	50	31.0	99	50
8	31.7	50	31.5	99	50	31.4	99	50	31.5	99	50
9	32.7	50	32.6	100	50	32.7	100	50	32.6	100	50
10	33.2	50	33.1	100	50	33.1	100	50	33.2	100	50
11	34.0	50	34.0	100	50	33.9	100	50	33.8	99	50
12	34.6	50	34.8	101	50	34.6	100	50	34.6	100	50
13	35.4	50	35.3	100	50	35.2	99	50	35.2	99	50
16	36.3	50	37.4	103	50	36.8	101	50	37.6	104	50
20	38.7	50	38.8	100	50	38.9	101	50	39.9	103	50
24	41.5	50	41.8	101	50	41.5	100	50	43.2	104	50
28	43.7	50	44.5	102	50	42.8	98	50	45.3	104	50
32	44.8	50	45.4	101	50	44.2	99	50	46.3	103	50
36	46.4	50	47.1	102	50	46.2	100	50	48.2	104	50
40	47.0	50	47.5	101	50	46.2	98	50	48.0	102	49
44	47.7	50	48.7	102	50	47.4	99	50	49.6	104	49
48	49.1	50	49.8	101	50	48.7	99	50	50.6	103	48
52	48.9	50	50.0	102	50	48.7	100	50	50.6	104	47
56	49.7	50	50.6	102	50	49.0	99	50	50.9	102	46
60	50.5	48	51.4	102	49	50.2	99	48	51.3	102	46
64	51.0	47	52.0	102	49	50.6	99	47	51.1	100	46
68	50.1	47	51.0	102	49	49.8	99	47	50.6	101	45
72	50.8	46	51.1	101	49	50.4	99	46	50.8	100	45
76	50.3	46	51.6	103	47	50.9	101	42	51.1	102	42
80	50.2	45	51.6	103	46	50.8	101	42	52.0	104	40
84	50.7	43	51.5	102	45	51.0	101	40	52.8	104	39
88	50.5	39	51.5	102	42	50.5	100	38	51.9	103	38
92	49.9	38	50.0	100	42	50.2	101	35	51.5	103	36
94	49.4	38	50.6	102	39	50.6	102	33	52.0	105	35
96	49.9	35	49.8	100	39	49.8	100	32	50.9	102	35
98	49.7	35	49.8	100	37	49.4	99	32	51.1	103	33
100	49.4	34	49.6	100	37	49.0	99	30	50.0	101	31
102	49.8	31	48.8	98	36	48.3	97	29	49.8	100	29
104	49.8	29	49.2	99	32	47.5	95	28	49.5	99	29
Mean for weeks											
1-13	31.1		31.1	100		30.9	99		31.0	100	
14-52	44.4		45.1	102		44.1	99		45.9	103	
53-104	50.1		50.6	101		49.9	100		51.1	102	

TABLE 10
Mean Body Weights and Survival of Female Mice in the 2-Year Inhalation Study of Isobutene

Weeks on Study	Chamber Control		500 ppm			2,000 ppm			8,000 ppm		
	Av. Wt. (g)	No. of Survivors	Av. Wt. (g)	Wt. (% of controls)	No. of Survivors	Av. Wt. (g)	Wt. (% of controls)	No. of Survivors	Av. Wt. (g)	Wt. (% of controls)	No. of Survivors
1	20.0	50	19.8	99	50	20.0	100	50	19.8	99	50
2	21.6	50	21.3	99	50	21.6	100	50	21.9	101	50
3	23.0	50	22.6	98	50	22.8	99	50	22.9	100	50
4	23.3	50	23.3	100	50	23.3	100	50	23.6	101	50
5	24.2	50	24.0	99	50	24.4	101	50	24.2	100	50
6	25.0	50	24.9	100	50	25.1	100	50	24.8	99	50
7	25.6	50	25.4	99	50	25.3	99	50	25.2	98	50
8	26.0	50	25.5	98	50	25.5	98	50	25.5	98	50
9	26.8	50	26.3	98	50	26.5	99	50	26.5	99	50
10	27.1	50	27.0	100	50	27.7	102	50	27.4	101	50
11	28.2	50	27.8	99	50	27.6	98	50	28.0	99	50
12	29.2	50	28.6	98	50	28.3	97	50	29.3	100	50
13	29.5	50	28.9	98	50	28.7	97	50	29.2	99	50
16	30.9	50	31.5	102	50	30.8	100	50	31.3	101	50
20	34.9	50	34.3	98	50	33.8	97	50	34.7	99	50
24	36.9	50	37.5	102	50	37.1	101	50	37.9	103	50
28	39.9	50	40.6	102	50	39.8	100	50	39.4	99	50
32	41.2	50	42.1	102	50	40.9	99	50	40.5	98	50
36	43.9	49	44.5	101	50	41.9	95	50	43.0	98	50
40	44.9	49	45.1	100	50	42.3	94	50	43.1	96	50
44	46.3	49	47.7	103	50	44.7	97	50	45.6	99	50
48	48.3	48	49.3	102	50	46.2	96	50	45.7	95	50
52	48.8	48	49.7	102	50	46.0	94	50	45.2	93	50
56	50.4	47	51.7	103	50	47.3	94	50	47.1	94	50
60	52.8	47	53.7	102	50	50.1	95	50	49.4	94	50
64	54.9	47	55.2	101	50	52.2	95	50	51.7	94	50
68	56.2	46	55.0	98	50	52.8	94	50	52.0	93	50
72	57.3	46	56.3	98	49	54.5	95	49	53.0	93	50
76	57.9	46	57.2	99	48	55.1	95	48	53.5	92	50
80	57.9	45	56.2	97	48	55.5	96	47	54.7	95	49
84	58.1	44	56.9	98	46	56.6	97	47	55.4	95	48
88	57.6	42	54.9	95	45	54.6	95	46	53.3	93	46
92	55.9	41	54.2	97	42	54.3	97	43	52.7	94	45
94	55.6	40	55.5	100	38	54.3	98	43	53.0	95	44
96	54.1	39	55.4	102	36	53.8	99	43	52.3	97	43
98	53.8	37	54.6	102	36	53.5	99	42	52.4	97	42
100	53.6	36	53.6	100	35	52.5	98	40	51.0	95	41
102	52.5	36	54.5	104	33	51.3	98	40	50.3	96	39
104	52.0	34	53.2	102	33	50.8	98	39	51.1	98	34
Mean for weeks											
1-13	25.3		25.0	99		25.1	99		25.3	100	
14-52	41.6		42.2	101		40.4	97		40.6	98	
53-104	55.0		54.9	100		53.1	97		52.1	95	

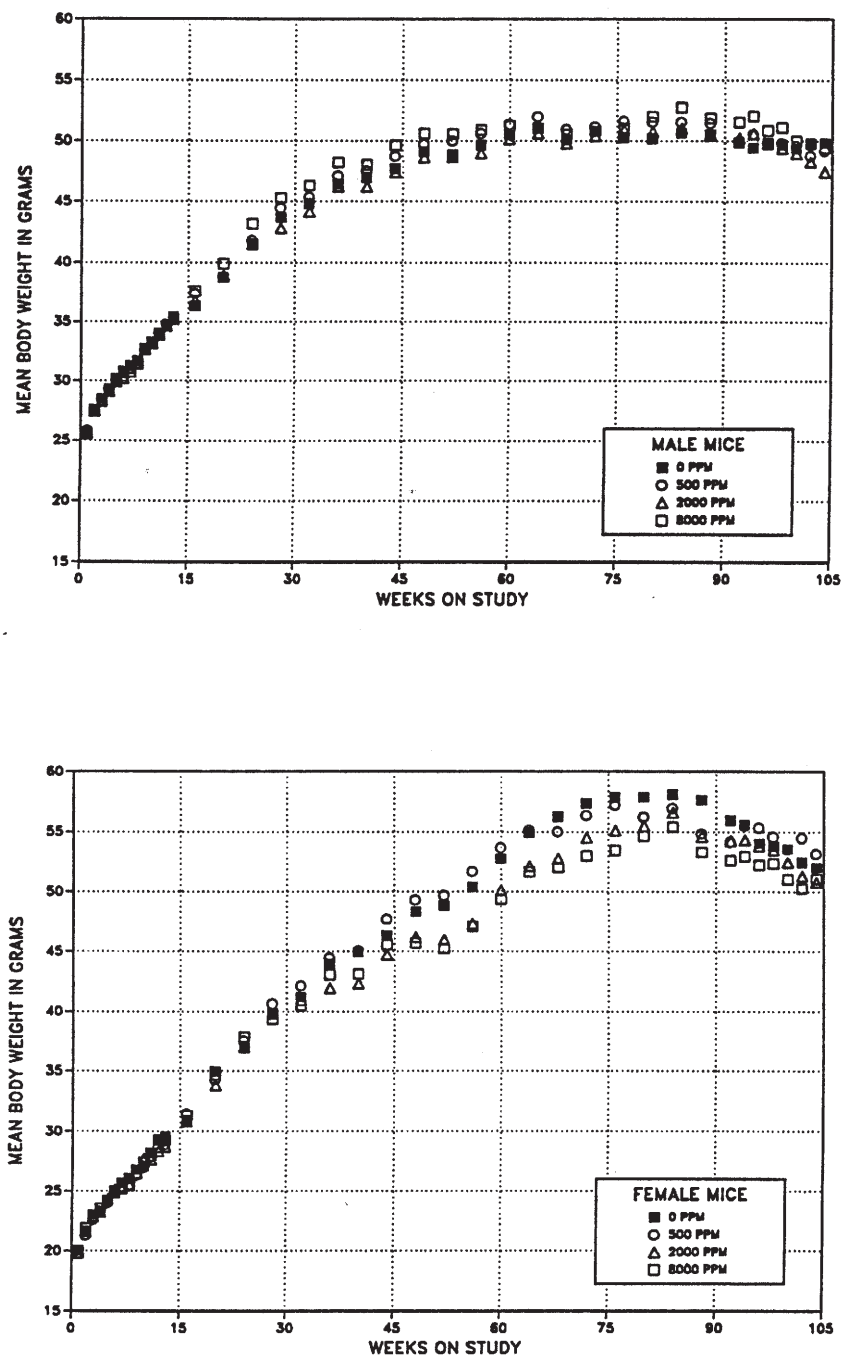

FIGURE 9
Growth Curves for Male and Female Mice
Exposed to Isobutene by Inhalation for 2 Years

***2-Hydroxyisobutyric Acid —
Biomarker of Exposure***

HIBA was measured in the urine of male and female mice as an indicator of isobutene exposure at 6, 12, and 18 months (Table I2). The amount of HIBA excreted increased with increasing exposure concentration (Figures 10 and 11). However, when HIBA concentration was normalized to isobutene

exposure concentration, the relative amount of HIBA excreted decreased as exposure concentrations increased (Figures 12 and 13). This was true at all three collection intervals for males and females. Exposure to isobutene had no effect on the quantity of urine or the amount of creatinine excreted.

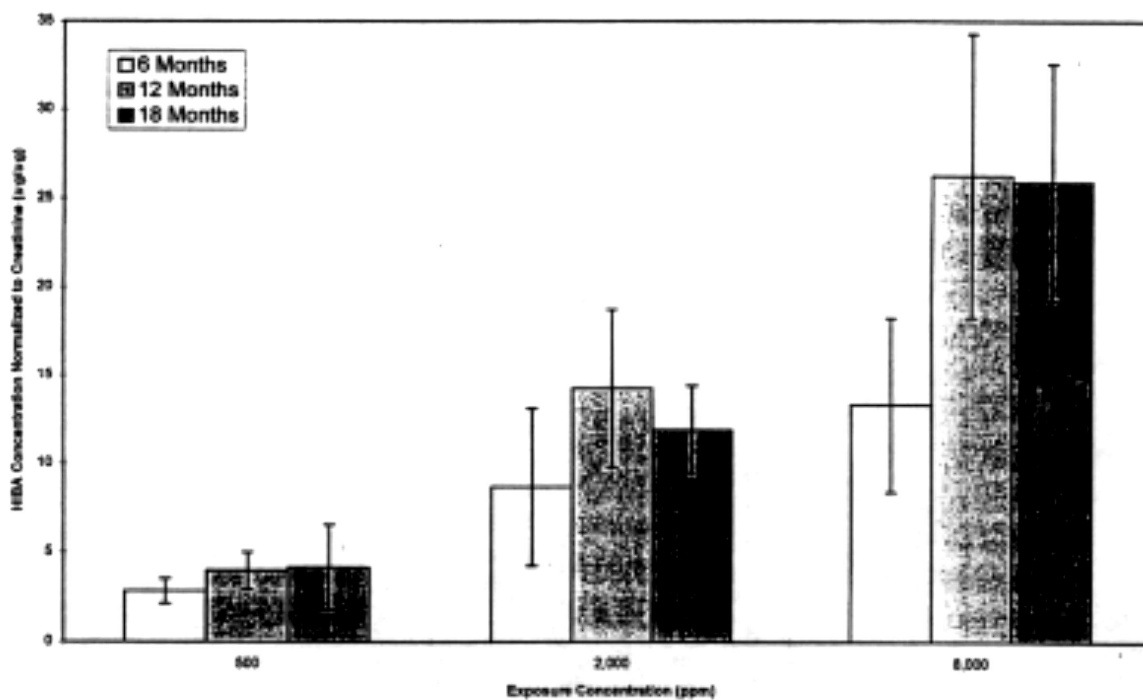

FIGURE 10
Mean (\pm Standard Deviation) 2-Hydroxyisobutyric Acid Concentration Normalized to Creatinine for Male Mice in the 2-Year Inhalation Study of Isobutene

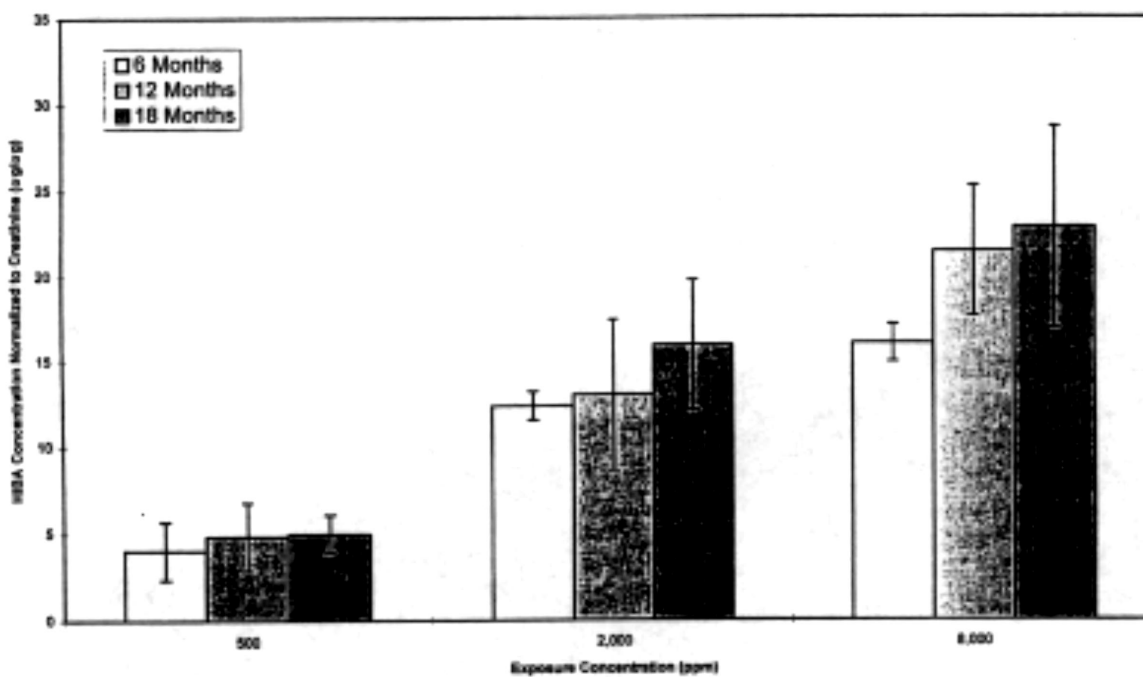

FIGURE 11
Mean (\pm Standard Deviation) 2-Hydroxyisobutyric Acid Concentration Normalized to Creatinine for Female Mice in the 2-Year Inhalation Study of Isobutene

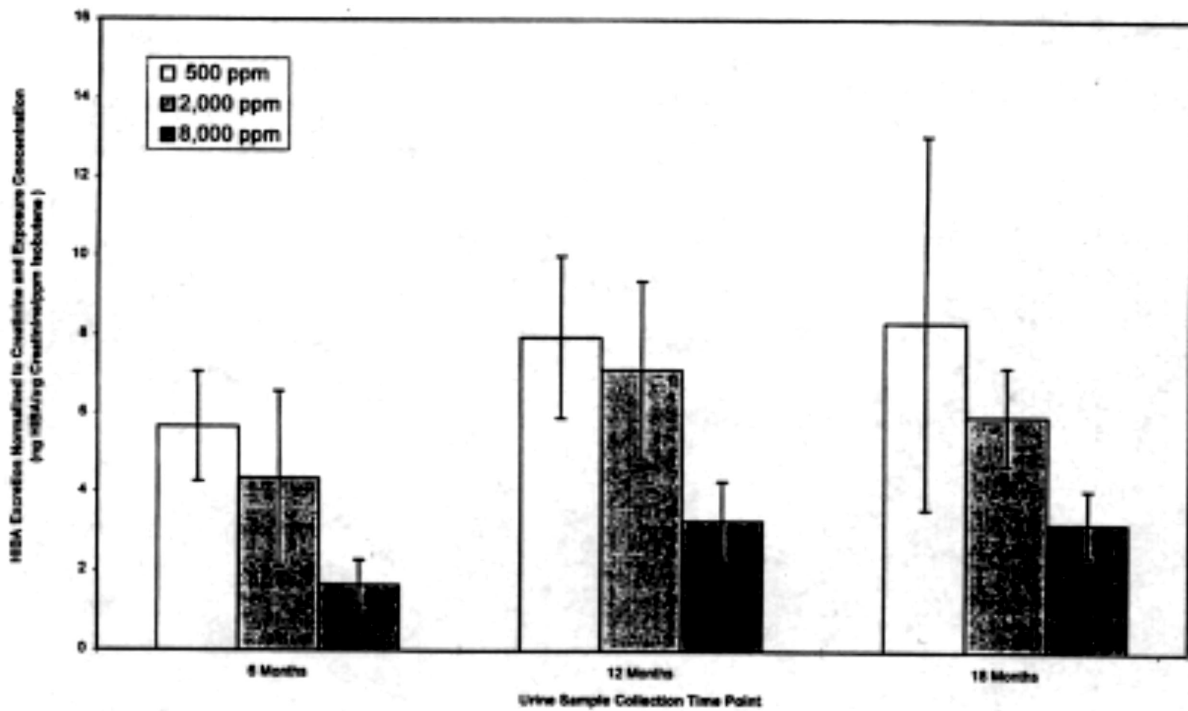

FIGURE 12
 Mean (± Standard Deviation) 2-Hydroxyisobutyric Excretion Normalized to Creatinine and Exposure Concentration for Male Mice in the 2-Year Inhalation Study of Isobutene

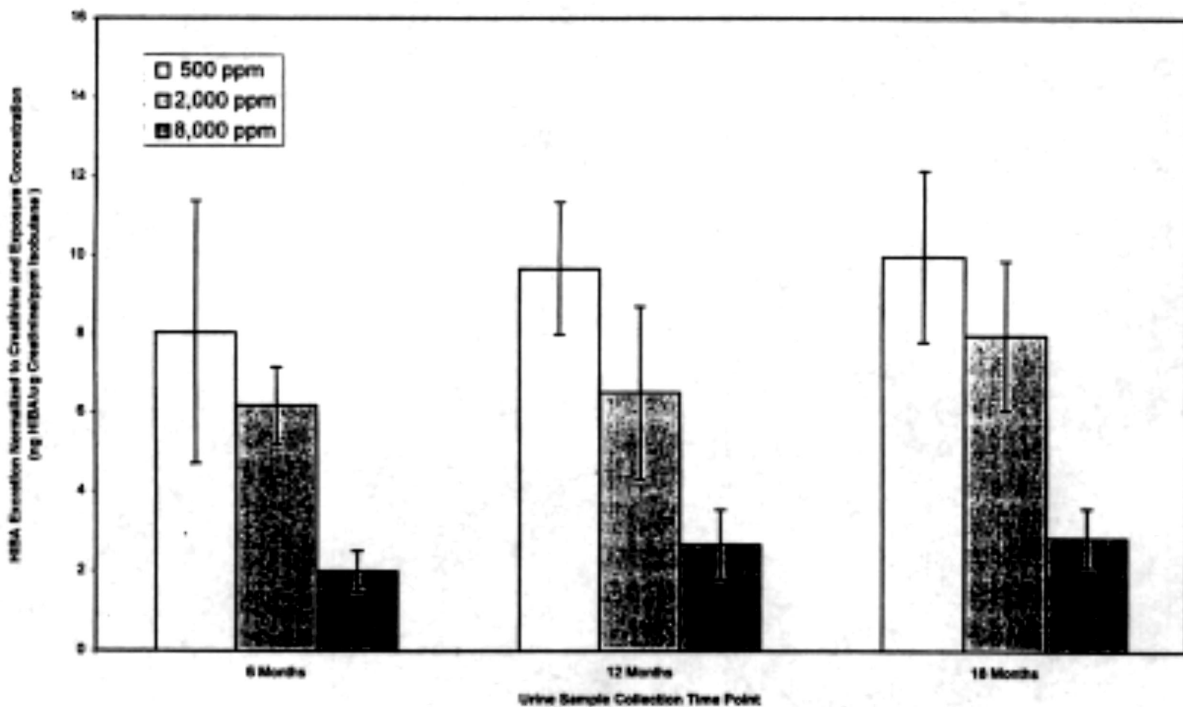

FIGURE 13
 Mean (± Standard Deviation) 2-Hydroxyisobutyric Excretion Normalized to Creatinine and Exposure Concentration for Female Mice in the 2-Year Inhalation Study of Isobutene

Pathology and Statistical Analyses

This section describes the statistically significant or biologically noteworthy changes in the incidences of nonneoplastic lesions of the nose. Summaries of the incidences of neoplasms and nonneoplastic lesions, individual animal tumor diagnoses, and statistical analyses of primary neoplasms that occurred with an incidence of at least 5% in at least one animal group are presented in Appendix C for male mice and Appendix D for female mice.

Nose: The incidences of hyaline degeneration of the respiratory epithelium in all groups of exposed males

and females were significantly greater than those in the chamber control groups and occurred with positive trends (Tables 11, C4, and D4). The incidences of hyaline degeneration of the olfactory epithelium in males occurred with a positive trend. The incidences of this lesion in 2,000 and 8,000 ppm males were significantly greater than that in the chamber controls. The incidences of hyaline degeneration of the olfactory epithelium in females also occurred with a positive trend; however, the incidences were not statistically different from that in the chamber controls.

TABLE 11
Incidences of Nonneoplastic Lesions of the Nose in Mice in the 2-Year Inhalation Study of Isobutene

	Chamber Control	500 ppm	2,000 ppm	8,000 ppm
Male				
Number Examined Microscopically	50	49	50	48
Respiratory Epithelium, Degeneration Hyaline ^a	6 (1.0) ^b	19** (1.2)	29** (1.5)	39** (1.8)
Olfactory Epithelium, Degeneration Hyaline	6 (1.0)	7 (1.1)	16** (1.6)	17** (1.4)
Female				
Number Examined Microscopically	47	50	49	50
Respiratory Epithelium, Degeneration Hyaline	21 (1.8)	39** (1.5)	41** (1.6)	48** (2.3)
Olfactory Epithelium, Degeneration Hyaline	17 (1.5)	19 (1.2)	24 (1.1)	27 (1.2)

** Significantly different ($P \leq 0.01$) from the chamber control group by the Poly-3 test

^a Number of animals with lesion

^b Average severity grade of lesions in affected animals: 1= minimal, 2= mild, 3= moderate, 4= marked

GENETIC TOXICOLOGY

Isobutene (0.001 to 0.027 mol/desiccator) was not mutagenic in *Salmonella typhimurium* strain TA97, TA98, TA100, or TA1535, with or without induced rat or hamster liver S9 enzymes (Table E1). *In vivo*, no increase in the frequency of micronucleated

normochromatic erythrocytes was seen in peripheral blood samples from male and female mice administered isobutene via inhalation for 14 weeks (Table E2).

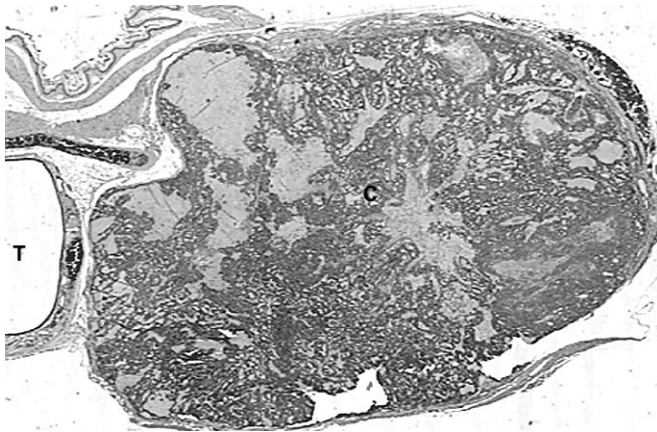

PLATE 1

Follicular cell carcinoma (C) of the thyroid gland from a control male rat in the 2-year inhalation study of isobutene. The carcinoma has a follicular/papillary pattern and has completely replaced an entire lobe of the thyroid gland. T indicates the trachea. H&E; 10 ×

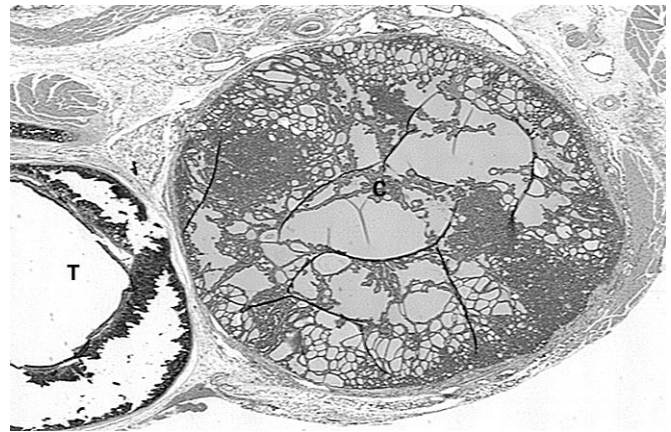

PLATE 2

Follicular cell carcinoma (C) of the thyroid gland from a male rat exposed to 8,000 ppm isobutene by inhalation for 2 years. The carcinoma has a follicular/papillary pattern and has completely replaced an entire lobe of the the thyroid gland. T indicates the trachea. H&E; 10 ×

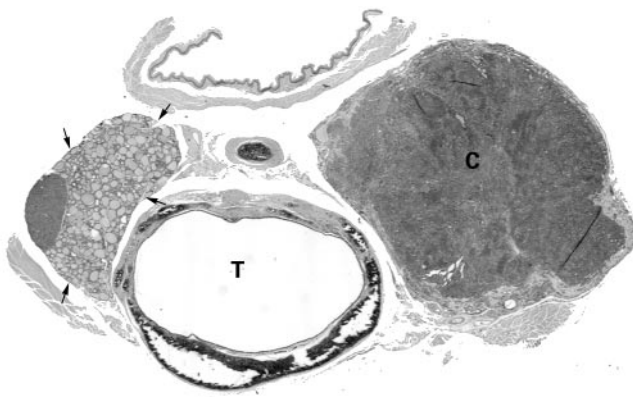

PLATE 3

Follicular cell carcinoma (C) of the thyroid gland from a male rat exposed to 8,000 ppm isobutene by inhalation for 2 years. The carcinoma has a solid pattern and has completely replaced an entire lobe of the thyroid gland. The contralateral lobe of the thyroid is normal (arrows). T indicates the trachea. H&E; 10 ×

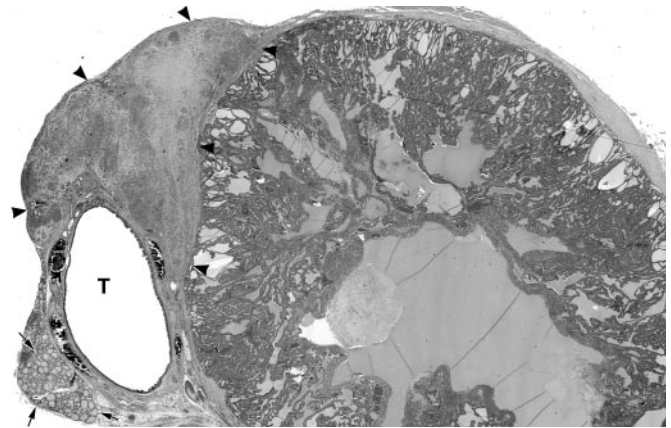

PLATE 4

Follicular cell carcinoma of the thyroid gland from a male rat exposed to 8,000 ppm isobutene by inhalation for 2 years. Note the mixed follicular/papillary pattern, the unilateral replacement of an entire lobe by the carcinoma, and locally extensive invasion of the adjacent peritracheal tissue (arrowheads). The contralateral lobe of the thyroid is normal (arrows). T indicates the trachea. H&E; 6 ×

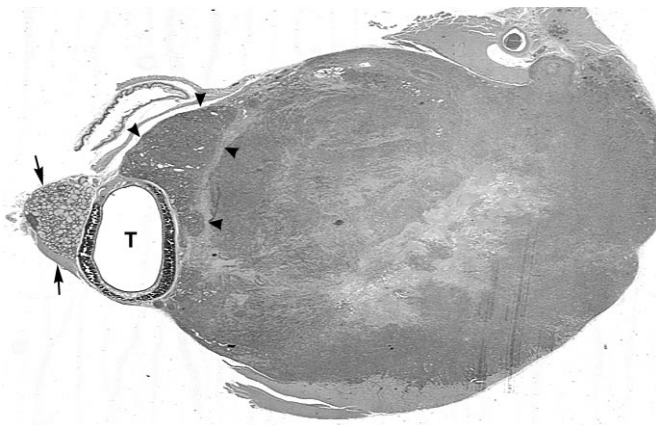

PLATE 5

Follicular cell carcinoma of the thyroid gland from a male rat exposed to 8,000 ppm isobutene by inhalation for 2 years. Note the primarily solid pattern, the unilateral replacement of an entire lobe by the carcinoma, and invasion of the adjacent peritracheal tissue (arrowheads). The contralateral lobe of the thyroid is normal (arrows). T indicates the trachea. H&E; 6 ×

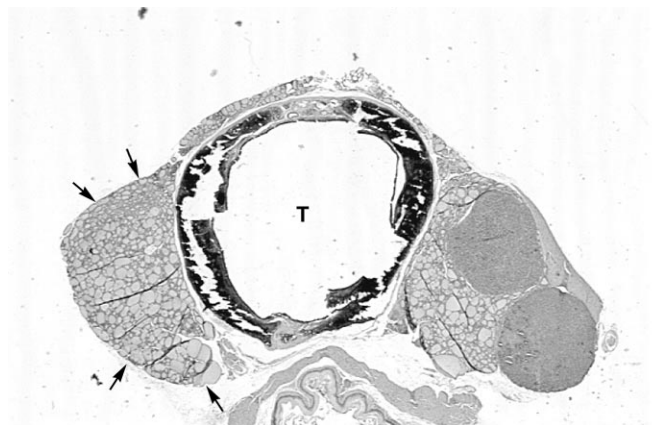

PLATE 6

Follicular cell carcinoma of the thyroid gland from a male rat exposed to 8,000 ppm isobutene by inhalation for 2 years. Note the primarily solid pattern and partial replacement of the lobe by the carcinoma. The contralateral lobe of the thyroid is normal. T indicates the trachea. H&E; 12 ×

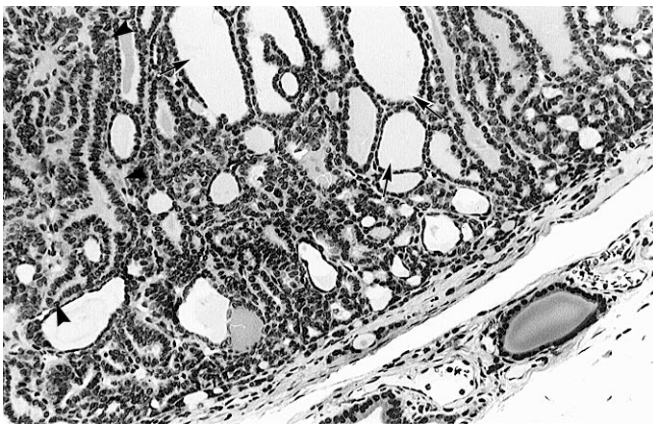

PLATE 7

Higher magnification of Plate 4. The neoplastic cells lining follicles (arrows) are uniformly cuboidal to low columnar. H&E; 175 ×

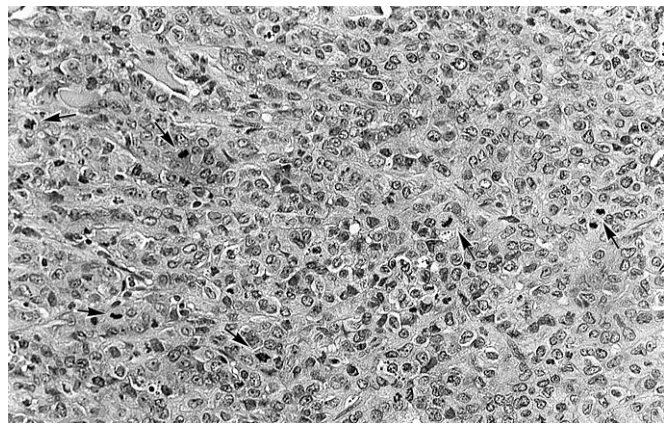

PLATE 8

Higher magnification of Plate 5 illustrating the solid pattern. The neoplastic cells are densely packed and there is moderate variation in cellular size and shape (pleomorphism). Note the high number of mitotic figures (arrows). H&E; 175 ×

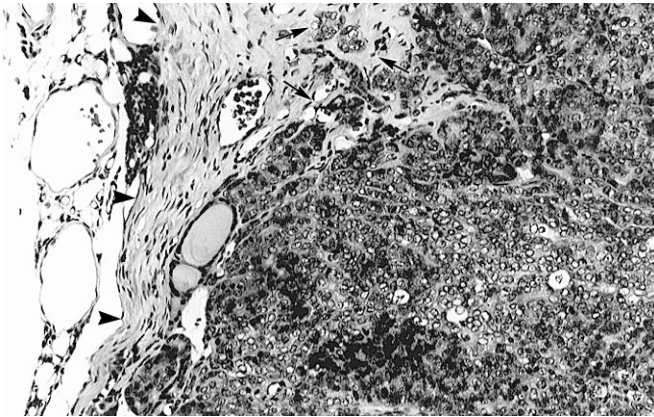

PLATE 9

Higher magnification of Plate 3 illustrating the solid pattern. Note invasion (arrows) of the surrounding scirrhous capsule (arrowheads). H&E; 175 ×



PLATE 10

Embolus of neoplastic cells (arrows) within the vasculature adjacent of the follicular cell carcinoma illustrated in Plate 5. H&E; 230 ×

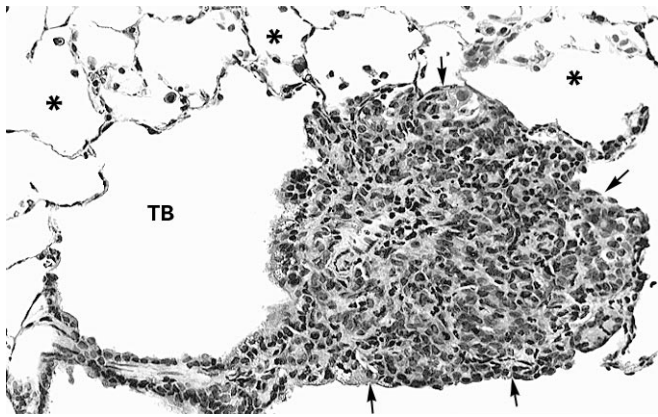

PLATE 11

Lung from the rat with the thyroid follicular cell carcinoma illustrated in Plate 5. Note a focus of metastatic neoplastic cells (arrows) adjacent to a terminal bronchiole (TB). Alveoli are indicated by asterisks. H&E; 230 ×

DISCUSSION AND CONCLUSIONS

Isobutene was evaluated for toxicity and carcinogenicity in 14-week and 2-year inhalation studies in male and female F344/N rats and B6C3F₁ mice. The highest concentration (8,000 ppm) that could be generated safely was used in all studies. This concentration is somewhat less than 50% of the lower explosion limit of isobutene (*Patty's*, 1994).

In the 14-week studies, there were no exposure-related deaths, body weight changes, clinical findings, effects on hematologic or clinical chemistry indices (rats), or biologically significant effects on male or female reproductive endpoints. No exposure-related increases in micronucleated erythrocytes were seen in mice. Kidney weights of male rats and male and female mice exposed to 8,000 ppm were greater than those of the chamber controls. For male rats and mice, these increases were approximately 10% or less, while the increases in female rats and mice were greater (about 20%). There were no histopathologic effects in the kidneys of exposed rats or mice. Liver weights of all exposed groups of female rats were also greater than those of the chamber controls; however, the increases did not occur in a concentration-related fashion, nor were there histopathologic effects in the liver. There were no exposure-related gross lesions in rats; however, a minimal hypertrophy of goblet cells lining the nasopharyngeal duct in the most caudal section of the nasal cavity was observed in all groups of exposed male and female rats. In mice, no lesions were detected grossly at necropsy or microscopically.

In the 2-year rat study, neither survival rates nor body weight gains were significantly affected by isobutene exposure. There were no exposure-related clinical findings. Isobutene exposure caused an increased incidence of thyroid gland follicular cell carcinoma in the 8,000 ppm male group compared to the chamber controls. The morphology of the carcinomas in this group was similar to the morphologic spectrum typical of spontaneously developing follicular cell carcinomas. There were no concurrent increases in the

incidences of thyroid gland follicular cell hyperplasia or adenoma in male rats, nor were there increased incidences of proliferative lesions of the thyroid gland in exposed female rats compared to the chamber controls. The historical control range for follicular cell carcinoma in male rats in inhalation studies is 0% to 4%, and the highest historical control incidence of this neoplasm by any route for male rats is 3/50 (6%) (in a dosed feed study). The five carcinomas in the 8,000 ppm male group were considered treatment related because of the significant increase over historical control rates for inhalation studies as well as all other routes of administration.

Isobutene, like the structurally related compounds propylene, ethylene, 1,3-butadiene, and isoprene, is metabolized to an epoxide, 2-methyl-1,2-epoxypropane (1,1-dimethyloxirane). Although isobutene is not mutagenic in *Salmonella typhimurium* itself, the isobutene epoxide is mutagenic, but only at high concentrations. It was also clastogenic to human lymphocytes *in vitro* (Jorritsma *et al.*, 1995). The epoxides of other olefins are mutagenic, and many are considered to be responsible for the carcinogenicity of the parent compound. For example, propylene was not carcinogenic in rats or mice (NTP, 1985a), whereas propylene oxide caused increased incidences of papillary adenoma of the nasal turbinates in male and female B6C3F₁ mice (NTP 1985b). 1,3-Butadiene (Owen *et al.*, 1987; NTP, 1993) and isoprene (Melnick *et al.*, 1994; NTP, 1998) were multisite carcinogens in rats and mice. Of importance is the fact that 1,3-butadiene caused thyroid gland follicular cell neoplasms in female rats following a 2-year exposure to concentrations up to 8,000 ppm. However, whether the isobutene epoxide 2-methyl-1,2-epoxypropane was responsible for the thyroid gland follicular cell carcinomas in male rats exposed to 8,000 ppm is not known, because the isobutene epoxide (at conditions of saturation) is detected in the exhaled air of rats at about 1% of that observed for 1,3-butadiene epoxide (1,2-epoxy-3-butene) or 7% of that observed for ethene oxide (Csanády *et al.*, 1991).

Exposure of rats to isobutene caused an increase, although marginal, in the incidences of hyaline degeneration of the olfactory epithelium of the nose in males and females; more importantly, the severities of this lesion (mild to moderate) were increased in exposed males and females in a concentration-related fashion. No nasal neoplasms were observed in exposed male or female rats.

During the 2-year mouse study, neither survival rates nor body weight gains of males were significantly affected by isobutene exposure. Although survival rates for female mice were not affected by exposure, female mice exposed to 2,000 or 8,000 ppm weighed slightly less than the chamber controls in the second year of the study. There were no treatment-related clinical findings in mice. The only lesions associated with exposure in mice were nonneoplastic nasal lesions in all exposed groups of males and females. Nasal lesions included hyaline degeneration of the respiratory and olfactory epithelium; the lesions were minimal to mild in severity and the incidences increased with increasing exposure concentration. Although they were not observed in the 14-week mouse study, these lesions are fairly common in long-term inhalation studies. No nasal neoplasms were observed in male or female mice.

Exposure to isobutene for 6, 12, or 18 months had no effect on urine output or the concentration of urinary creatinine in male or female rats or mice. During the course of the study, there was no consistent time-related trend relative to the duration of exposure and the amount of 2-hydroxyisobutyric acid (HIBA) excreted per exposure concentration. Although the amount of HIBA/ μg creatinine did increase with increasing exposure concentration at each of the three collection time points, when normalized to exposure

concentration (ng HIBA/ μg creatinine per ppm isobutene), it decreased with increasing exposure concentration. The fact that the urinary excretion of HIBA was not directly proportional to exposure concentration indicates nonlinear toxicokinetics. This was true for male and female rats and mice. This finding was consistent with the findings of Csanády *et al.* (1991), who determined that isobutene metabolism was directly proportional to its concentration at concentrations of 500 ppm and less. Their assumptions were based on isobutene elimination from a closed inhalation exposure system. These data were used to set exposure concentrations for the 2-year rat and mouse isobutene studies in lieu of significant exposure-related toxicological effects following 14-week exposure to 8,000 ppm. Based on the 2-year results and the studies of Csanády *et al.* (1991) and Henderson *et al.* (1993), concentrations of isobutene greater than 500 ppm should result in kinetic events that are saturated.

CONCLUSIONS

Under the conditions of these 2-year inhalation studies, there was *some evidence of carcinogenic activity** of isobutene in male F344/N rats based on an increased incidence of follicular cell carcinoma of the thyroid gland. There was *no evidence of carcinogenic activity* of isobutene in female F344/N rats or male or female B6C3F₁ mice exposed to 500, 2,000, or 8,000 ppm.

Exposure to isobutene by inhalation for 2 years resulted in increased incidences and/or severities of nasal lesions including hyaline degeneration of the olfactory epithelium in male and female rats and mice and hyaline degeneration of the respiratory epithelium in male and female mice.

* Explanation of Levels of Evidence of Carcinogenic Activity is on page 8. A summary of the Technical Reports Review Subcommittee comments and the public discussion on this Technical Report appears on page 10.

REFERENCES

- The Aldrich Library of FT-IR Spectra* (1985). 1st ed. (C.J. Pouchert, Ed.), Vol. 3, p. 28B. Aldrich Chemical Company, Inc., Milwaukee, WI.
- Ashby, J., and Tennant, R.W. (1991). Definitive relationships among chemical structure, carcinogenicity and mutagenicity for 301 chemicals tested by the U.S. NTP. *Mutat. Res.* **257**, 229-306.
- Bailer, A.J., and Portier, C.J. (1988). Effects of treatment-induced mortality and tumor-induced mortality on tests for carcinogenicity in small samples. *Biometrics* **44**, 417-431.
- Bielor, G.S., and Williams, R.L. (1993). Ratio of estimates, the delta method, and quantal response tests for increased carcinogenicity. *Biometrics* **49**, 793-801.
- Bogaards, J.J.P., Venekamp, J.C., and van Bladeren, P.J. (1996). The biotransformation of isoprene and the two isoprene monoepoxides by human cytochrome P450 enzymes, compared to mouse and rat liver microsomes. *Chem. Biol. Interact.* **102**, 169-182.
- Boorman, G.A., Montgomery, C.A., Jr., Eustis, S.L., Wolfe, M.J., McConnell, E.E., and Hardisty, J.F. (1985). Quality assurance in pathology for rodent carcinogenicity studies. In *Handbook of Carcinogen Testing* (H.A. Milman and E.K. Weisburger, Eds.), pp. 345-357. Noyes Publications, Park Ridge, NJ.
- Castelain, Ph., Criado, B., Cornet, M., Laib, R., Rogiers, V., and Kirsch-Volders, M. (1993). Comparative mutagenicity of structurally related aliphatic epoxides in a modified Salmonella/microsome assay. *Mutagenesis* **8**, 387-393.
- Code of Federal Regulations (CFR) **21**, Part 58.
- Cornet, M., Sonck, W., Callaerts, A., Csanády, G., Vercruyssen, A., Laib, R.J., and Rogiers, V. (1991). In vitro biotransformation of 2-methylpropene (isobutene): Epoxide formation in mice liver. *Arch. Toxicol.* **65**, 263-267.
- Cornet, M., Castelain, Ph., Vercruyssen, A., Laib, R., Kirsch-Volders, M., and Rogiers, V. (1992). Mutagenicity of 2-methylpropene (isobutene) and its epoxide in a modified Salmonella assay for volatile compounds. *Mutat. Res.* **271**, 213-221.
- Cornet, M., Callaerts, A., Vercruyssen, A., and Rogiers, V. (1995a). In vitro biotransformation of 2-methylpropene (isobutene) in rat lung tissue in comparison with liver tissue. *Arch. Toxicol.* **70**, 64-67.
- Cornet, M., Callaerts, A., Jorritsma, U., Bolt, H., Vercruyssen, A., and Rogiers, V. (1995b). Species-dependent differences in biotransformation pathways of 2-methylpropene (isobutene). *Chem. Res. Toxicol.* **8**, 987-992.
- Cox, D.R. (1972). Regression models and life-tables. *J. R. Stat. Soc.* **B34**, 187-220.
- Crawford, B.D. (1985). Perspectives on the somatic mutation model of carcinogenesis. In *Advances in Modern Environmental Toxicology. Mechanisms and Toxicity of Chemical Carcinogens and Mutagens* (M.A. Mehlman, W.G. Flamm, and R.J. Lorentzen, Eds.), pp. 13-59. Princeton Scientific Publishing Co., Princeton, NJ.
- Csanády, G.A., Freise, D., Denk, B., Filser, J.G., Cornet, M., Rogiers, V., and Laib, R.J. (1991). Investigation of species differences in isobutene (2-methylpropene) metabolism between mice and rats. *Arch. Toxicol.* **65**, 100-105.

- Csanády, G.A., Guengerich, F.P., and Bond, J.A. (1992). Comparison of the biotransformation of 1,3-butadiene and its metabolites, butadiene mono-epoxide, by hepatic and pulmonary tissues from humans, rats, and mice. *Carcinogenesis* **13**, 1143-1153.
- Del Monte, M., Citti, L., and Gervasi, P.G. (1985). Isoprene metabolism by liver microsomal mono-oxygenases. *Xenobiotica* **15**, 591-597.
- Dixon, W.J., and Massey, F.J., Jr. (1951). *Introduction to Statistical Analysis*, 1st ed., pp. 145-147. McGraw-Hill Book Company, New York.
- Dunn, O.J. (1964). Multiple comparisons using rank sums. *Technometrics* **6**, 241-252.
- Dunnett, C.W. (1955). A multiple comparison procedure for comparing several treatments with a control. *J. Am. Stat. Assoc.* **50**, 1096-1121.
- Frank, H., Hintze, T., Bimboes, D., and Remmer, H. (1980). Monitoring lipid peroxidation by breath analysis: Endogenous hydrocarbons and their metabolic elimination. *Toxicol. Appl. Pharmacol.* **56**, 337-344.
- Gervasi, P.G., and Longo, V. (1990). Metabolism and mutagenicity of isoprene. *Environ. Health Perspect.* **86**, 85-87.
- Hawley's Condensed Chemical Dictionary* (1993). 12th ed. (R.J. Lewis, Sr., Ed.), p. 652. Van Nostrand Reinhold, New York.
- Hazardous Substances Data Bank (HSDB) (1997). Maintained, reviewed, and updated on the National Library of Medicine's Toxicology Data Network (TOXNET). Available through the MEDLARS system.
- Henderson, R.F., Sabourin, P.J., Bechtold, W.E., Steinberg, B., and Chang, I.-Y. (1993). Disposition of inhaled isobutene in F344/N rats. *Toxicol. Appl. Pharmacol.* **123**, 50-61.
- Hollander, M., and Wolfe, D.A. (1973). *Nonparametric Statistical Methods*, pp. 120-123. John Wiley and Sons, New York.
- Jonckheere, A.R. (1954). A distribution-free *k*-sample test against ordered alternatives. *Biometrika* **41**, 133-145.
- Jorritsma, U., Cornet, M., Van Hummelen, P., Bolt, H.M., Vercruyssen, A., Kirsch-Volders, M., and Rogiers, V. (1995). Comparative mutagenicity of 2-methylpropene (isobutene), its epoxide 2-methyl-1,2-epoxypropane and propylene oxide in the *in vitro* micronucleus test using human lymphocytes. *Mutagenesis* **10**, 101-104.
- Kaplan, E.L., and Meier, P. (1958). Nonparametric estimation from incomplete observations. *J. Am. Stat. Assoc.* **53**, 457-481.
- Longo, V., Citti, L., and Gervasi, P.G. (1985). Hepatic microsomal metabolism of isoprene in various rodents. *Toxicol. Lett.* **29**, 33-37.
- McConnell, E.E., Solleveld, H.A., Swenberg, J.A., and Boorman, G.A. (1986). Guidelines for combining neoplasms for evaluation of rodent carcinogenesis studies. *JNCI* **76**, 283-289.
- MacGregor, J.T., Wehr, C.M., Henika, P.R., and Shelby, M.D. (1990). The *in vivo* erythrocyte micronucleus test: Measurement at steady state increases assay efficiency and permits integration with toxicity studies. *Fundam. Appl. Toxicol.* **14**, 513-522.
- Malvoisin, E., and Roberfroid, M. (1982). Hepatic microsomal metabolism of 1,3-butadiene. *Xenobiotica* **12**, 137-144.
- Malvoisin, E., Lhoest, G., Poncelet, F., Roberfroid, M., and Mercier, M. (1979). Identification and quantitation of 1,2-epoxybutene-3 as the primary metabolite of 1,3-butadiene. *J. Chromatogr.* **178**, 419-425.

- Margolin, B.H., Risko, K.J., Frome, E.L., and Tice, R.R. (1990). A general purpose statistical analysis program for micronucleus assay data. Appendix 2: Micronucleus data management and analysis version 1.4a. Integrated Laboratory Systems, Research Triangle Park, NC.
- Maronpot, R.R., and Boorman, G.A. (1982). Interpretation of rodent hepatocellular proliferative alterations and hepatocellular tumors in chemical safety assessment. *Toxicol. Pathol.* **10**, 71-80.
- Material Safety Data Sheet* (1988). Isobutylene. Sheet No. 674. Genium Publishing Corporation, Schenectady, NY.
- Melnick, R.L., Sills, R.C., Roycroft, J.H., Chou, B.J., Ragan, H.A., and Miller, R.A. (1994). Isoprene, an endogenous hydrocarbon and industrial chemical, induces multiple organ neoplasia in rodents after 26 weeks of inhalation exposure. *Cancer Res.* **54**, 5333-5339.
- The Merck Index* (1989). 11th ed. (S. Budavari, Ed.), p. 810. Merck and Company, Rahway, NJ.
- Miller, J.A., and Miller, E.C. (1977). Ultimate chemical carcinogens as reactive mutagenic electrophiles. In *Origins of Human Cancer* (H.H. Hiatt, J.D. Watson, and J.A. Winsten, Eds.), pp. 605-627. Cold Spring Harbor Laboratory, Cold Spring Harbor, NY.
- Morrison, D.F. (1976). *Multivariate Statistical Methods*, 2nd ed., pp. 170-179. McGraw-Hill Book Company, New York.
- National Cancer Institute (NCI) (1976). Guidelines for Carcinogen Bioassay in Small Rodents. Technical Report Series No. 1. NIH Publication No. 76-801. U.S. Department of Health, Education, and Welfare, Public Health Service, National Institutes of Health, Bethesda, MD.
- National Institute for Occupational Safety and Health (NIOSH) (1990). National Occupational Exposure Survey (1981-1983), unpublished provisional data as of July 1, 1990. NIOSH, Cincinnati, OH.
- National Institutes of Health (NIH) (1978). Open Formula Rat and Mouse Ration (NIH-07). Specification NIH-11-1335. U.S. Department of Health, Education, and Welfare, Public Health Service, NIH, Bethesda, MD.
- National Library of Medicine (1997). MEDLINE, CANCERLIT, TOXLINE. Toxicology Data Bank databases maintained by the National Library of Medicine. U.S. Department of Health and Human Services, Public Health Service, National Institutes of Health, Bethesda, MD.
- National Toxicology Program (NTP) (1985a). Toxicology and Carcinogenesis Studies of Propylene (CAS No. 115-07-1) in F344/N Rats and B6C3F₁ Mice (Inhalation Studies). Technical Report Series No. 272. NIH Publication No. 86-2528. U.S. Department of Health and Human Services, Public Health Service, National Institutes of Health, Research Triangle Park, NC.
- National Toxicology Program (NTP) (1985b). Toxicology and Carcinogenesis Studies of Propylene Oxide (CAS No. 75-56-9) in F344/N Rats and B6C3F₁ Mice (Inhalation Studies). Technical Report Series No. 267. NIH Publication No. 85-2527. U.S. Department of Health and Human Services, Public Health Service, National Institutes of Health, Research Triangle Park, NC.
- National Toxicology Program (NTP) (1987). National Toxicology Program (NTP). Technical Protocol for Sperm Morphology and Vaginal Cytology Evaluation in Toxicity Testing for Rats and Mice, 10/31/82 version (updated April 1987). Research Triangle Park, NC.
- National Toxicology Program (NTP) (1993). Toxicology and Carcinogenesis Studies of 1,3-Butadiene (CAS No. 106-99-0) in B6C3F₁ Mice (Inhalation Studies). Technical Report Series No. 434. NIH Publication No. 93-3165. U.S. Department of Health and Human Services, Public Health Service, National Institutes of Health, Research Triangle Park, NC.

- National Toxicology Program (NTP) (1995). Toxicity Studies of Isoprene (CAS No. 78-79-5) Administered by Inhalation to F344/N Rats and B6C3F₁ Mice. Toxicity Report Series No. 31. NIH Publication No. 95-3354. U.S. Department of Health and Human Services, Public Health Service, National Institutes of Health, Research Triangle Park, NC.
- National Toxicology Program (NTP) (1998). Toxicology and Carcinogenesis Studies of Isoprene (CAS No. 78-79-5) in F344/N Rats (Inhalation Studies). Technical Report Series No. 486. NIH Publication No. 99-3976. U.S. Department of Health and Human Services, Public Health Service, National Institutes of Health, Research Triangle Park, NC. (In press)
- Owen, P.E., Glaister, J.R., Gaunt, I.F., and Pullinger, D.H. (1987). Inhalation toxicity studies with 1,3-butadiene. 3. Two year toxicity/carcinogenicity study in rats. *Am. Ind. Hyg. Assoc. J.* **48**, 407-413.
- Patty's Industrial Hygiene and Toxicology* (1994). 4th ed. (G.D. Clayton and F.E. Clayton, Eds.), Vol. 2B, pp. 1242-1243, 1247-1248. John Wiley and Sons, Inc., New York.
- Peter, H., Wiegand, H.J., Bolt, H.M., Greim, H., Walter, G., Berg, M., and Filser, J.G. (1987). Pharmacokinetics of isoprene in mice and rats. *Toxicol. Lett.* **36**, 9-14.
- Peter, H., Wiegand, H.-J., Filser, J.G., Bolt, H.M., and Laib, R.J. (1990). Inhalation pharmacokinetics of isoprene in rats and mice. *Environ. Health Perspect.* **86**, 89-92.
- Piegorsch, W.W., and Bailer, A.J. (1997). *Statistics for Environmental Biology and Toxicology*, Section 6.3.2. Chapman and Hall, London.
- Placke, M.E., Griffis, L., Bird, M., Bus, J., Persing, R.L., and Cox, L.A., Jr. (1996). Chronic inhalation oncogenicity study of isoprene in B6C3F₁ mice. *Toxicology* **110**, 253-262.
- Portier, C.J., and Bailer, A.J. (1989). Testing for increased carcinogenicity using a survival-adjusted quantal response test. *Fundam. Appl. Toxicol.* **12**, 731-737.
- Portier, C.J., Hedges, J.C., and Hoel, D.G. (1986). Age-specific models of mortality and tumor onset for historical control animals in the National Toxicology Program's carcinogenicity experiments. *Cancer Res.* **46**, 4372-4378.
- Sax's Dangerous Properties of Industrial Materials* (1992). 8th ed. (R.J. Lewis, Sr., Ed.), p. 2015. Van Nostrand Reinhold, New York.
- Shelby, M.D., and Witt, K.L. (1995). Comparison of results from mouse bone marrow chromosome aberration and micronucleus tests. *Environ. Mol. Mutagen.* **25**, 302-313.
- Shelby, M.D., Erexson, G.L., Hook, G.J., and Tice, R.R. (1993). Evaluation of a three-exposure mouse bone marrow micronucleus protocol: Results with 49 chemicals. *Environ. Mol. Mutagen.* **21**, 160-179.
- Shirley, E. (1977). A non-parametric equivalent of Williams' test for contrasting increasing dose levels of a treatment. *Biometrics* **33**, 386-389.
- Staab, R.J., and Sarginson, N.J. (1984). Lack of genetic toxicity of isobutylene gas. *Mutat. Res.* **130**, 259-260.
- Straus, D.S. (1981). Somatic mutation, cellular differentiation, and cancer causation. *JNCI* **67**, 233-241.
- Tarone, R.E. (1975). Tests for trend in life table analysis. *Biometrika* **62**, 679-682.
- Tennant, R.W., Margolin, B.H., Shelby, M.D., Zeiger, E., Haseman, J.K., Spalding, J., Caspary, W., Resnick, M., Stasiewicz, S., Anderson, B., and Minor, R. (1987). Prediction of chemical carcinogenicity in rodents from *in vitro* genetic toxicity assays. *Science* **236**, 933-941.

Voogd, C.E., van der Stel, J.J., and Jacobs, J.J.J.A.A. (1981). The mutagenic action of aliphatic epoxides. *Mutat. Res.* **89**, 269-282.

Williams, D.A. (1971). A test for differences between treatment means when several dose levels are compared with a zero dose control. *Biometrics* **27**, 103-117.

Williams, D.A. (1972). The comparison of several dose levels with a zero dose control. *Biometrics* **28**, 519-531.

Wistuba, D., Weigand, K., and Peter, H. (1994). Stereoselectivity of in vitro isoprene metabolism. *Chem. Res. Toxicol.* **7**, 336-343.

Zeiger, E., Haseman, J.K., Shelby, M.D., Margolin, B.H., and Tennant, R.W. (1990). Evaluation of four in vitro genetic toxicity tests for predicting rodent carcinogenicity: Confirmation of earlier results with 41 additional chemicals. *Environ. Mol. Mutagen.* **16** (Suppl. 18), 1-14.

Zeiger, E., Anderson, B., Haworth, S., Lawlor, T., and Mortelmans, K. (1992). Salmonella mutagenicity tests: V. Results from the testing of 311 chemicals. *Environ. Mol. Mutagen.* **19** (Suppl. 21), 2-141.

APPENDIX A
SUMMARY OF LESIONS IN MALE RATS
IN THE 2-YEAR INHALATION STUDY
OF ISOBUTENE

TABLE A1	Summary of the Incidence of Neoplasms in Male Rats in the 2-Year Inhalation Study of Isobutene	60
TABLE A2	Individual Animal Tumor Pathology of Male Rats in the 2-Year Inhalation Study of Isobutene	64
TABLE A3	Statistical Analysis of Primary Neoplasms in Male Rats in the 2-Year Inhalation Study of Isobutene	84
TABLE A4	Historical Incidence of Thyroid Gland Follicular Cell Neoplasms in Chamber Control Male F344/N Rats	88
TABLE A5	Summary of the Incidence of Nonneoplastic Lesions in Male Rats in the 2-Year Inhalation Study of Isobutene	89

TABLE A1
Summary of the Incidence of Neoplasms in Male Rats in the 2-Year Inhalation Study of Isobutene^a

	Chamber Control	500 ppm	2,000 ppm	8,000 ppm
Disposition Summary				
Animals initially in study	50	50	50	50
Early deaths				
Moribund	39	40	37	41
Natural deaths	4	5	7	1
Survivors				
Terminal sacrifice	7	5	6	8
Animals examined microscopically	50	50	50	50
Alimentary System				
Intestine large, colon	(49)	(48)	(48)	(49)
Intestine large, rectum	(47)	(49)	(49)	(49)
Polyp adenomatous	1 (2%)			
Intestine large, cecum	(48)	(47)	(49)	(49)
Intestine small, jejunum	(47)	(46)	(47)	(49)
Carcinoma	1 (2%)		1 (2%)	
Hemangiosarcoma			1 (2%)	
Intestine small, ileum	(47)	(46)	(47)	(49)
Leiomyosarcoma				1 (2%)
Liver	(50)	(50)	(50)	(50)
Histiocytic sarcoma	1 (2%)		2 (4%)	
Osteosarcoma, metastatic, bone	1 (2%)			
Mesentery	(15)	(10)	(8)	(11)
Liposarcoma		1 (10%)		
Oral mucosa			(1)	
Pharyngeal, squamous cell papilloma			1 (100%)	
Pancreas	(50)	(50)	(50)	(50)
Adenoma	2 (4%)	1 (2%)		
Salivary glands	(50)	(50)	(50)	(50)
Stomach, forestomach	(50)	(50)	(50)	(50)
Stomach, glandular	(50)	(49)	(50)	(50)
Tongue	(1)			(1)
Hemangiosarcoma				1 (100%)
Cardiovascular System				
Heart	(50)	(50)	(50)	(50)
Endocrine System				
Adrenal cortex	(50)	(49)	(50)	(50)
Adenoma	1 (2%)			1 (2%)
Osteosarcoma, metastatic, bone	1 (2%)			
Adrenal medulla	(50)	(49)	(50)	(50)
Pheochromocytoma malignant		1 (2%)	1 (2%)	2 (4%)
Pheochromocytoma benign	13 (26%)	7 (14%)	8 (16%)	11 (22%)
Bilateral, pheochromocytoma malignant				1 (2%)
Bilateral, pheochromocytoma benign	10 (20%)	11 (22%)	8 (16%)	12 (24%)
Islets, pancreatic	(50)	(49)	(50)	(50)
Adenoma	4 (8%)		1 (2%)	4 (8%)
Carcinoma	4 (8%)	2 (4%)	1 (2%)	4 (8%)
Pituitary gland	(50)	(49)	(50)	(49)
Pars distalis, adenoma	43 (86%)	40 (82%)	40 (80%)	41 (84%)

TABLE A1
Summary of the Incidence of Neoplasms in Male Rats in the 2-Year Inhalation Study of Isobutene

	Chamber Control	500 ppm	2,000 ppm	8,000 ppm
Endocrine System (continued)				
Thyroid gland	(48)	(48)	(48)	(50)
C-cell, adenoma	5 (10%)	4 (8%)	5 (10%)	7 (14%)
C-cell, carcinoma			2 (4%)	1 (2%)
Follicular cell, carcinoma	1 (2%)			5 (10%)
General Body System				
None				
Genital System				
Epididymis	(50)	(50)	(50)	(50)
Preputial gland	(50)	(50)	(49)	(50)
Adenoma	4 (8%)	2 (4%)	2 (4%)	1 (2%)
Carcinoma	1 (2%)	2 (4%)	2 (4%)	3 (6%)
Bilateral, carcinoma		1 (2%)		
Prostate	(50)	(49)	(50)	(50)
Adenoma				1 (2%)
Seminal vesicle	(50)	(47)	(50)	(50)
Testes	(50)	(50)	(50)	(50)
Bilateral, interstitial cell, adenoma	13 (26%)	14 (28%)	17 (34%)	14 (28%)
Interstitial cell, adenoma	10 (20%)	14 (28%)	12 (24%)	11 (22%)
Hematopoietic System				
Bone marrow	(50)	(48)	(50)	(50)
Histiocytic sarcoma			2 (4%)	
Lymph node	(4)	(11)	(10)	(10)
Histiocytic sarcoma	1 (25%)		1 (10%)	
Iliac, osteosarcoma, metastatic, bone	1 (25%)			
Pancreatic, histiocytic sarcoma			1 (10%)	
Lymph node, bronchial	(30)	(41)	(35)	(45)
Histiocytic sarcoma	1 (3%)		2 (6%)	
Lymph node, mandibular	(47)	(47)	(49)	(49)
Lymph node, mesenteric	(50)	(50)	(49)	(50)
Lymph node, mediastinal	(46)	(42)	(44)	(45)
Carcinoma, metastatic, thyroid gland				1 (2%)
Histiocytic sarcoma			1 (2%)	
Spleen	(50)	(49)	(50)	(50)
Histiocytic sarcoma			1 (2%)	
Thymus	(40)	(42)	(38)	(42)
Integumentary System				
Mammary gland	(41)	(41)	(40)	(44)
Carcinoma		1 (2%)		
Carcinoma, multiple	1 (2%)			
Fibroadenoma	1 (2%)		1 (3%)	1 (2%)

TABLE A1
Summary of the Incidence of Neoplasms in Male Rats in the 2-Year Inhalation Study of Isobutene

	Chamber Control	500 ppm	2,000 ppm	8,000 ppm
Integumentary System (continued)				
Skin	(50)	(50)	(50)	(50)
Basal cell adenoma				2 (4%)
Basal cell carcinoma		2 (4%)		
Keratoacanthoma	3 (6%)	4 (8%)	2 (4%)	4 (8%)
Squamous cell papilloma		1 (2%)	2 (4%)	1 (2%)
Sebaceous gland, adenoma		2 (4%)	1 (2%)	
Subcutaneous tissue, fibroma	1 (2%)		2 (4%)	
Subcutaneous tissue, histiocytic sarcoma			1 (2%)	
Subcutaneous tissue, lipoma	1 (2%)			
Subcutaneous tissue, rhabdomyosarcoma				1 (2%)
Subcutaneous tissue, sarcoma	1 (2%)			
Subcutaneous tissue, schwannoma benign	1 (2%)			
Subcutaneous tissue, schwannoma malignant		1 (2%)		
Subcutaneous tissue, pinna, melanoma malignant		1 (2%)		
Musculoskeletal System				
Bone	(50)	(50)	(50)	(50)
Osteosarcoma	1 (2%)	1 (2%)		
Skeletal muscle	(1)		(1)	(1)
Histiocytic sarcoma			1 (100%)	
Nervous System				
Brain	(50)	(50)	(50)	(50)
Astrocytoma malignant	1 (2%)			
Histiocytic sarcoma			1 (2%)	
Oligodendroglioma malignant	1 (2%)			
Respiratory System				
Lung	(50)	(50)	(50)	(50)
Alveolar/bronchiolar adenoma	2 (4%)	2 (4%)	2 (4%)	
Alveolar/bronchiolar carcinoma		2 (4%)	1 (2%)	1 (2%)
Carcinoma, metastatic, thyroid gland				1 (2%)
Histiocytic sarcoma	1 (2%)		2 (4%)	
Osteosarcoma, metastatic, bone	1 (2%)			
Mediastinum, alveolar/bronchiolar carcinoma, metastatic, lung		1 (2%)		
Nose	(49)	(49)	(50)	(49)
Special Senses System				
Eye	(3)		(4)	
Zymbal's gland		(2)	(1)	
Carcinoma		2 (100%)	1 (100%)	
Urinary System				
Kidney	(50)	(50)	(50)	(50)
Histiocytic sarcoma			1 (2%)	
Stromal nephroma	1 (2%)			1 (2%)
Renal tubule, adenoma	2 (4%)	1 (2%)		2 (4%)
Renal tubule, carcinoma			2 (4%)	
Urinary bladder	(50)	(49)	(50)	(50)

TABLE A1
Summary of the Incidence of Neoplasms in Male Rats in the 2-Year Inhalation Study of Isobutene

	Chamber Control	500 ppm	2,000 ppm	8,000 ppm
Systemic Lesions				
Multiple organs ^b	(50)	(50)	(50)	(50)
Histiocytic sarcoma	1 (2%)		2 (4%)	
Leukemia mononuclear	21 (42%)	21 (42%)	20 (40%)	31 (62%)
Mesothelioma malignant	3 (6%)	2 (4%)		
Neoplasm Summary				
Total animals with primary neoplasms ^c	50	48	49	50
Total primary neoplasms	155	143	138	165
Total animals with benign neoplasms	48	46	49	49
Total benign neoplasms	117	103	104	113
Total animals with malignant neoplasms	31	33	28	40
Total malignant neoplasms	38	40	34	52
Total animals with metastatic neoplasms	1	1		1
Total metastatic neoplasms	4	1		2

^a Number of animals examined microscopically at the site and the number of animals with neoplasm

^b Number of animals with any tissue examined microscopically

^c Primary neoplasms: all neoplasms except metastatic neoplasms

TABLE A2
Individual Animal Tumor Pathology of Male Rats in the 2-Year Inhalation Study of Isobutene: Chamber Control

Number of Days on Study	3	4	4	4	4	5	5	5	5	5	5	5	5	5	5	5	5	5	6	6	6	6	6	6	6	6	6	6	
Carcass ID Number	7	6	7	7	9	1	3	3	4	4	5	6	7	7	8	8	9	1	1	2	2	3	3	3	3	4	9	7	5
Carcass ID Number	0	0	0	0	0	0	0	0	0	0	0	0	0	0	0	0	0	0	0	0	0	0	0	0	0	0	0	0	0
Carcass ID Number	0	0	2	0	4	3	3	4	4	0	1	0	2	3	2	4	3	5	2	4	2	0	1	0	0	9	7	4	8
Carcass ID Number	9	7	6	7	5	6	9	9	0	4	2	0	4	6	0	0	0	0	4	6	1	8	3	6	9	5			
Alimentary System																													
Esophagus	+	+	+	+	+	+	+	+	+	+	+	+	+	+	+	+	+	+	+	+	+	+	+	+	+	+	+	+	+
Intestine large, colon	+	+	+	+	+	+	+	+	+	A	+	+	+	+	+	+	+	+	+	+	+	+	+	+	+	+	+	+	+
Intestine large, rectum	+	+	+	+	+	+	+	+	+	A	+	I	+	+	+	+	+	+	+	+	+	+	+	+	+	+	+	+	+
Polyp adenomatous																													
Intestine large, cecum	+	+	+	+	+	+	+	+	+	A	+	+	A	+	+	+	+	+	+	+	+	+	+	+	+	+	+	+	+
Intestine small, duodenum	+	+	+	+	+	+	+	+	+	A	+	+	+	+	+	+	+	+	+	+	+	+	+	+	+	+	+	+	+
Intestine small, jejunum	+	A	+	+	+	+	+	+	+	A	+	+	A	+	+	+	+	+	+	+	+	+	+	+	+	+	+	+	+
Carcinoma																													
Intestine small, ileum	+	A	+	+	+	+	+	+	+	A	+	+	A	+	+	+	+	+	+	+	+	+	+	+	+	+	+	+	+
Liver	+	+	+	+	+	+	+	+	+	+	+	+	+	+	+	+	+	+	+	+	+	+	+	+	+	+	+	+	+
Histiocytic sarcoma																													
Osteosarcoma, metastatic, bone																													
Mesentery				+			+	+																					
Pancreas	+	+	+	+	+	+	+	+	+	+	+	+	+	+	+	+	+	+	+	+	+	+	+	+	+	+	+	+	+
Adenoma																													
Salivary glands	+	+	+	+	+	+	+	+	+	+	+	+	+	+	+	+	+	+	+	+	+	+	+	+	+	+	+	+	+
Stomach, forestomach	+	+	+	+	+	+	+	+	+	+	+	+	+	+	+	+	+	+	+	+	+	+	+	+	+	+	+	+	+
Stomach, glandular	+	+	+	+	+	+	+	+	+	+	+	+	+	+	+	+	+	+	+	+	+	+	+	+	+	+	+	+	+
Tongue																													
Tooth													+																+
Cardiovascular System																													
Blood vessel																													
Heart	+	+	+	+	+	+	+	+	+	+	+	+	+	+	+	+	+	+	+	+	+	+	+	+	+	+	+	+	+
Endocrine System																													
Adrenal cortex	+	+	+	+	+	+	+	+	+	+	+	+	+	+	+	+	+	+	+	+	+	+	+	+	+	+	+	+	+
Adenoma																													
Osteosarcoma, metastatic, bone																													
Adrenal medulla	+	+	+	+	+	+	+	+	+	+	+	+	+	+	+	+	+	+	+	+	+	+	+	+	+	+	+	+	+
Pheochromocytoma benign																													
Bilateral, pheochromocytoma benign																													
Islets, pancreatic	+	+	+	+	+	+	+	+	+	+	+	+	+	+	+	+	+	+	+	+	+	+	+	+	+	+	+	+	+
Adenoma																													
Carcinoma																													
Parathyroid gland	+	+	+	+	+	+	+	+	+	+	+	+	+	+	+	+	+	+	+	+	+	+	+	+	+	+	+	+	+
Pituitary gland	+	+	+	+	+	+	+	+	+	+	+	+	+	+	+	+	+	+	+	+	+	+	+	+	+	+	+	+	+
Pars distalis, adenoma																													
Thyroid gland	+	A	+	+	+	+	+	+	+	+	+	+	+	+	+	+	+	+	+	+	+	+	+	+	+	+	+	+	+
C-cell, adenoma																													
Follicular cell, carcinoma																													
General Body System																													
None																													

+: Tissue examined microscopically
A: Autolysis precludes examination

M: Missing tissue
I: Insufficient tissue

X: Lesion present
Blank: Not examined

**TABLE A2
 Individual Animal Tumor Pathology of Male Rats in the 2-Year Inhalation Study of Isobutene: Chamber Control**

Number of Days on Study	6 6 6 6 6 6 6 6 6 6 6 6 7 7 7 7 7 7 7 7 7 7 7 7	
	4 5 6 6 7 7 8 8 8 8 9 9 0 0 0 1 1 2 3 3 3 3 3 3 3	
	8 0 1 6 0 8 1 3 3 4 1 2 5 6 6 9 9 0 3 3 3 3 3 3 3	
Carcass ID Number	0 0 0 0 0 0 0 0 0 0 0 0 0 0 0 0 0 0 0 0 0 0 0 0 0	Total
	4 1 4 1 2 3 3 2 4 3 1 4 4 2 3 1 3 1 0 1 1 1 2 2 3	Tissues/
	9 3 8 4 9 0 4 5 5 5 6 6 4 1 7 8 9 9 3 0 1 2 7 8 6	Tumors
Special Senses System		
Eye		3
Urinary System		
Kidney		50
Stromal nephroma		1
Renal tubule, adenoma		2
Urinary bladder		50
Systemic Lesions		
Multiple organs		50
Histiocytic sarcoma		1
Leukemia mononuclear		21
Mesothelioma malignant		3

TABLE A2
Individual Animal Tumor Pathology of Male Rats in the 2-Year Inhalation Study of Isobutene: 2,000 ppm

Number of Days on Study	6	6	6	6	6	6	6	6	6	6	6	6	7	7	7	7	7	7	7	7	7	7	7	7	7	7	7	
	1	2	2	2	2	5	5	5	5	7	7	8	0	0	0	0	0	1	1	3	3	3	3	3	3	3	3	
	4	0	7	8	8	0	2	4	4	1	8	0	0	1	5	6	6	4	4	3	3	3	3	3	3	3	3	
Carcass ID Number	4	4	4	4	4	4	4	4	4	4	4	4	4	4	4	4	4	4	4	4	4	4	4	4	4	4	4	Total Tissues/ Tumors
Alimentary System																												
Esophagus	+	+	+	+	+	+	+	+	+	+	+	+	+	+	+	+	+	+	+	+	+	+	+	+	+	+	+	50
Intestine large, colon	A	+	+	+	+	+	+	+	+	+	+	+	+	+	+	A	+	+	+	+	+	+	+	+	+	+	+	48
Intestine large, rectum	+	+	+	+	+	+	+	+	+	+	+	+	+	+	+	+	+	+	+	+	+	+	+	+	+	+	+	49
Intestine large, cecum	+	+	+	+	+	+	+	+	+	+	+	+	+	+	+	A	+	+	+	+	+	+	+	+	+	+	+	49
Intestine small, duodenum	+	+	+	+	+	+	+	+	+	+	+	+	+	+	+	+	+	+	+	+	+	+	+	+	+	+	+	50
Intestine small, jejunum	A	+	+	+	+	+	+	+	A	+	+	+	+	+	+	A	+	+	+	+	+	+	+	+	+	+	+	47
Carcinoma											X																1	
Hemangiosarcoma																											X	1
Intestine small, ileum	A	+	+	+	+	+	+	+	A	+	+	+	+	+	+	A	+	+	+	+	+	+	+	+	+	+	+	47
Liver	+	+	+	+	+	+	+	+	+	+	+	+	+	+	+	+	+	+	+	+	+	+	+	+	+	+	+	50
Histiocytic sarcoma																										X		2
Mesentery										+	+																+	8
Oral mucosa																												1
Pharyngeal, squamous cell papilloma																												1
Pancreas	+	+	+	+	+	+	+	+	+	+	+	+	+	+	+	+	+	+	+	+	+	+	+	+	+	+	+	50
Salivary glands	+	+	+	+	+	+	+	+	+	+	+	+	+	+	+	+	+	+	+	+	+	+	+	+	+	+	+	50
Stomach, forestomach	+	+	+	+	+	+	+	+	+	+	+	+	+	+	+	+	+	+	+	+	+	+	+	+	+	+	+	50
Stomach, glandular	+	+	+	+	+	+	+	+	+	+	+	+	+	+	+	+	+	+	+	+	+	+	+	+	+	+	+	50
Tooth																												1
Cardiovascular System																												
Blood vessel																												2
Heart	+	+	+	+	+	+	+	+	+	+	+	+	+	+	+	+	+	+	+	+	+	+	+	+	+	+	+	50
Endocrine System																												
Adrenal cortex	+	+	+	+	+	+	+	+	+	+	+	+	+	+	+	+	+	+	+	+	+	+	+	+	+	+	+	50
Adrenal medulla	+	+	+	+	+	+	+	+	+	+	+	+	+	+	+	+	+	+	+	+	+	+	+	+	+	+	+	50
Pheochromocytoma malignant																												1
Pheochromocytoma benign						X			X								X		X	X			X					8
Bilateral, pheochromocytoma benign			X										X	X		X						X				X		8
Islets, pancreatic	+	+	+	+	+	+	+	+	+	+	+	+	+	+	+	+	+	+	+	+	+	+	+	+	+	+	+	50
Adenoma																									X			1
Carcinoma			X																									1
Parathyroid gland	+	+	+	+	+	+	+	+	+	+	+	+	+	+	+	+	+	+	+	+	+	+	+	+	+	+	M	49
Pituitary gland	+	+	+	+	+	+	+	+	+	+	+	+	+	+	+	+	+	+	+	+	+	+	+	+	+	+	+	50
Pars distalis, adenoma	X	X		X	X	X	X		X	X	X			X	X	X	X	X	X	X	X	X	X	X	X	X	X	40
Thyroid gland	+	+	+	+	+	+	+	+	A	+	+	+	+	+	+	+	+	+	+	+	+	+	+	+	+	+	+	48
C-cell, adenoma											X			X	X	X		X	X									5
C-cell, carcinoma																											X	2
General Body System																												
None																												
Genital System																												
Epididymis	+	+	+	+	+	+	+	+	+	+	+	+	+	+	+	+	+	+	+	+	+	+	+	+	+	+	+	50
Preputial gland	+	+	+	+	+	+	+	+	+	+	+	+	+	+	+	+	+	+	+	+	+	+	+	+	+	+	+	49
Adenoma						X			X																			2
Carcinoma																												2
Prostate	+	+	+	+	+	+	+	+	+	+	+	+	+	+	+	+	+	+	+	+	+	+	+	+	+	+	+	50
Seminal vesicle	+	+	+	+	+	+	+	+	+	+	+	+	+	+	+	+	+	+	+	+	+	+	+	+	+	+	+	50
Testes	+	+	+	+	+	+	+	+	+	+	+	+	+	+	+	+	+	+	+	+	+	+	+	+	+	+	+	50
Bilateral, interstitial cell, adenoma	X	X						X	X	X	X	X	X			X	X	X	X	X	X	X	X	X	X	X	X	17
Interstitial cell, adenoma			X					X								X										X	X	12

TABLE A2
Individual Animal Tumor Pathology of Male Rats in the 2-Year Inhalation Study of Isobutene: 2,000 ppm

Number of Days on Study	6	6	6	6	6	6	6	6	6	6	6	7	7	7	7	7	7	7	7	7	7	7	7	7	7						
	1	2	2	2	2	5	5	5	5	7	7	8	0	0	0	0	0	1	1	3	3	3	3	3	3						
	4	0	7	8	8	0	2	4	4	1	8	0	0	1	5	6	6	4	4	3	3	3	3	3							
Carcass ID Number	4	4	4	4	4	4	4	4	4	4	4	4	4	4	4	4	4	4	4	4	4	4	4	4	4	4		Total			
	3	0	4	3	4	0	2	2	4	1	1	2	4	1	2	1	1	1	1	4	2	2	3	3	4	4		Tissues/ Tumors			
	4	3	4	5	0	6	8	2	9	7	3	9	5	9	4	0	5	4	2	0	7	1	9	3	7						
Hematopoietic System																															
Bone marrow	+	+	+	+	+	+	+	+	+	+	+	+	+	+	+	+	+	+	+	+	+	+	+	+	+	+		50			
Histiocytic sarcoma																											X		2		
Lymph node		+	+				+		+																		+	+	+	10	
Histiocytic sarcoma																											X		1		
Pancreatic, histiocytic sarcoma																											X		1		
Lymph node, bronchial	+	+	+	+	+	+	+	+	+	+	+	M	+	+	M	+	+	+	+	+	+	+	+	+	+	+	+	M	+	35	
Histiocytic sarcoma																											X		2		
Lymph node, mandibular	+	+	+	+	+	+	+	+	+	+	+	+	+	+	+	+	M	+	+	+	+	+	+	+	+	+	+	+	+	49	
Lymph node, mesenteric	+	+	+	+	+	+	+	+	+	+	+	+	+	+	+	+	+	+	+	+	+	+	+	+	+	+	+	M	+	+	49
Lymph node, mediastinal	+	+	+	+	+	+	+	+	+	+	+	+	+	+	+	+	+	+	+	+	+	+	+	+	+	+	+	+	+	44	
Histiocytic sarcoma																														1	
Spleen	+	+	+	+	+	+	+	+	+	+	+	+	+	+	+	+	+	+	+	+	+	+	+	+	+	+	+	+	+	50	
Histiocytic sarcoma																														1	
Thymus	M	+	M	+	+	M	M	+	+	+	+	M	+	+	+	+	+	+	+	M	+	+	+	+	+	+	+	+	38		
Integumentary System																															
Mammary gland	+	M	+	M	M	+	+	+	+	+	+	+	+	+	+	+	M	+	+	+	+	+	+	+	+	+	M	I	+	40	
Fibroadenoma																											X			1	
Skin	+	+	+	+	+	+	+	+	+	+	+	+	+	+	+	+	+	+	+	+	+	+	+	+	+	+	+	+	+	50	
Keratoacanthoma																											X			2	
Squamous cell papilloma									X																	X				2	
Sebaceous gland, adenoma												X																		1	
Subcutaneous tissue, fibroma											X						X													2	
Subcutaneous tissue, histiocytic sarcoma																										X				1	
Musculoskeletal System																															
Bone	+	+	+	+	+	+	+	+	+	+	+	+	+	+	+	+	+	+	+	+	+	+	+	+	+	+	+	+		50	
Skeletal muscle																												+		1	
Histiocytic sarcoma																										X				1	
Nervous System																															
Brain	+	+	+	+	+	+	+	+	+	+	+	+	+	+	+	+	+	+	+	+	+	+	+	+	+	+	+	+		50	
Histiocytic sarcoma																														1	
Respiratory System																															
Larynx	+	+	+	+	+	+	+	+	+	+	+	+	+	+	+	+	+	+	+	+	+	+	+	+	+	+	+	+		50	
Lung	+	+	+	+	+	+	+	+	+	+	+	+	+	+	+	+	+	+	+	+	+	+	+	+	+	+	+	+		50	
Alveolar/bronchiolar adenoma											X																			2	
Alveolar/bronchiolar carcinoma																		X												1	
Histiocytic sarcoma																										X				2	
Nose	+	+	+	+	+	+	+	+	+	+	+	+	+	+	+	+	+	+	+	+	+	+	+	+	+	+	+	+		50	
Trachea	+	+	+	+	+	+	+	+	+	+	+	+	+	+	+	+	+	+	+	+	+	+	+	+	+	+	+	+		50	
Special Senses System																															
Eye							+													+							+			4	
Zymbal's gland																											+			1	
Carcinoma																										X				1	

TABLE A2
Individual Animal Tumor Pathology of Male Rats in the 2-Year Inhalation Study of Isobutene: 2,000 ppm

Number of Days on Study	3	4	4	4	4	5	5	5	5	5	5	5	5	5	5	5	5	5	5	5	5	5	5	5	6	6	6
	5	5	8	9	9	0	1	1	2	2	5	5	5	5	6	6	7	7	8	8	8	8	9	0	1	1	
	2	3	0	6	7	0	2	6	0	0	1	2	5	8	5	8	4	9	0	3	5	0	7	4	4		
Carcass ID Number	4	4	4	4	4	4	4	4	4	4	4	4	4	4	4	4	4	4	4	4	4	4	4	4	4	4	4
	2	4	3	3	0	2	0	1	2	3	1	3	4	0	0	5	0	1	2	4	0	1	3	0	3		
	3	6	8	7	1	6	9	1	1	6	6	3	1	7	2	0	8	2	5	8	4	8	0	5	2		
Urinary System																											
Kidney	+	+	+	+	+	+	+	+	+	+	+	+	+	+	+	+	+	+	+	+	+	+	+	+	+	+	+
Histiocytic sarcoma																											
Renal tubule, carcinoma																											
Urinary bladder	+	+	+	+	+	+	+	+	+	+	+	+	+	+	+	+	+	+	+	+	+	+	+	+	+	+	+
Systemic Lesions																											
Multiple organs	+	+	+	+	+	+	+	+	+	+	+	+	+	+	+	+	+	+	+	+	+	+	+	+	+	+	+
Histiocytic sarcoma				X																							
Leukemia mononuclear					X	X			X		X				X			X					X		X		

TABLE A2
Individual Animal Tumor Pathology of Male Rats in the 2-Year Inhalation Study of Isobutene: 2,000 ppm

Number of Days on Study	6	6	6	6	6	6	6	6	6	6	6	6	6	7	7	7	7	7	7	7	7	7	7	7	7	7	7	7	7	7	7	7	7	7	
	1	2	2	2	2	5	5	5	5	7	7	8	0	0	0	0	0	0	1	1	3	3	3	3	3	3	3	3	3	3	3	3	3	3	
	4	0	7	8	8	0	2	4	4	1	8	0	0	1	5	6	6	4	4	3	3	3	3	3	3	3	3	3	3	3	3	3	3		
Carcass ID Number	4	4	4	4	4	4	4	4	4	4	4	4	4	4	4	4	4	4	4	4	4	4	4	4	4	4	4	4	4	4	4	4	4	Total	
	3	0	4	3	4	0	2	2	4	1	1	2	4	1	2	1	1	1	4	2	2	3	3	4	4								Tissues/ Tumors		
	4	3	4	5	0	6	8	2	9	7	3	9	5	9	4	0	5	4	2	0	7	1	9	3	7										
Urinary System																																			
Kidney	+	+	+	+	+	+	+	+	+	+	+	+	+	+	+	+	+	+	+	+	+	+	+	+	+	+	+	+	+	+	+	+	+	50	
Histiocytic sarcoma																																		1	
Renal tubule, carcinoma														X							X													2	
Urinary bladder	+	+	+	+	+	+	+	+	+	+	+	+	+	+	+	+	+	+	+	+	+	+	+	+	+	+	+	+	+	+	+	+	+	50	
Systemic Lesions																																			
Multiple organs	+	+	+	+	+	+	+	+	+	+	+	+	+	+	+	+	+	+	+	+	+	+	+	+	+	+	+	+	+	+	+	+	+	50	
Histiocytic sarcoma																																			2
Leukemia mononuclear	X	X	X	X		X		X	X			X	X						X									X	X					20	

**TABLE A2
Individual Animal Tumor Pathology of Male Rats in the 2-Year Inhalation Study of Isobutene: 8,000 ppm**

Number of Days on Study	4	5	5	5	5	5	5	5	5	6	6	6	6	6	6	6	6	6	6	6	6	6	6	6			
	9	0	2	3	3	4	6	7	8	0	0	0	0	1	1	1	3	3	3	4	4	5	5	5	6		
	0	5	5	4	4	0	0	6	3	4	4	7	8	0	1	8	1	6	6	7	8	0	0	8	4		
Carcass ID Number	6	6	6	6	6	6	6	6	6	6	6	6	6	6	6	6	6	6	6	6	6	6	6	6	6		
	3	4	2	0	1	2	2	1	1	1	4	4	2	3	0	4	3	3	4	1	0	0	4	3	0		
	9	5	1	3	4	7	6	7	8	9	8	6	8	1	9	2	5	8	9	6	1	6	4	2	2		
Genital System (continued)																											
Testes	+	+	+	+	+	+	+	+	+	+	+	+	+	+	+	+	+	+	+	+	+	+	+	+	+	+	
Bilateral, interstitial cell, adenoma											X					X		X				X	X		X		
Interstitial cell, adenoma										X						X				X						X	
Hematopoietic System																											
Bone marrow	+	+	+	+	+	+	+	+	+	+	+	+	+	+	+	+	+	+	+	+	+	+	+	+	+	+	
Lymph node		+	+												+						+						
Lymph node, bronchial	M	+	+	+	+	M	M	M	+	+	+	+	+	+	+	+	+	+	+	+	+	+	+	+	+	+	
Lymph node, mandibular	+	+	+	+	+	+	+	+	+	M	+	+	+	+	+	+	+	+	+	+	+	+	+	+	+	+	
Lymph node, mesenteric	+	+	+	+	+	+	+	+	+	+	+	+	+	+	+	+	+	+	+	+	+	+	+	+	+	+	
Lymph node, mediastinal	+	+	+	+	+	+	+	+	+	M	+	+	M	+	+	+	+	+	+	+	+	+	+	+	+	+	
Carcinoma, metastatic, thyroid gland																										X	
Spleen	+	+	+	+	+	+	+	+	+	+	+	+	+	+	+	+	+	+	+	+	+	+	+	+	+	+	
Thymus	+	M	M	+	+	+	M	+	+	M	+	+	+	+	+	+	+	+	+	+	+	+	+	M	+	+	
Integumentary System																											
Mammary gland	+	+	+	+	+	+	+	+	+	+	M	+	+	+	+	+	+	+	+	+	+	+	+	M	+	+	+
Fibroadenoma																										X	
Skin	+	+	+	+	+	+	+	+	+	+	+	+	+	+	+	+	+	+	+	+	+	+	+	+	+	+	
Basal cell adenoma																											
Keratoacanthoma																											
Squamous cell papilloma																											
Subcutaneous tissue, rhabdomyosarcoma																											
Musculoskeletal System																											
Bone	+	+	+	+	+	+	+	+	+	+	+	+	+	+	+	+	+	+	+	+	+	+	+	+	+	+	
Skeletal muscle																											
Nervous System																											
Brain	+	+	+	+	+	+	+	+	+	+	+	+	+	+	+	+	+	+	+	+	+	+	+	+	+	+	
Respiratory System																											
Larynx	+	+	+	+	+	+	+	+	+	+	+	+	+	+	+	+	+	+	+	+	+	+	+	+	+	+	
Lung	+	+	+	+	+	+	+	+	+	+	+	+	+	+	+	+	+	+	+	+	+	+	+	+	+	+	
Alveolar/bronchiolar carcinoma																											
Carcinoma, metastatic, thyroid gland																										X	
Nose	+	+	+	+	+	+	+	+	A	+	+	+	+	+	+	+	+	+	+	+	+	+	+	+	+	+	
Trachea	+	+	+	+	+	+	+	+	+	+	+	+	+	+	+	+	+	+	+	+	+	+	+	+	+	+	
Special Senses System																											
None																											
Urinary System																											
Kidney	+	+	+	+	+	+	+	+	+	+	+	+	+	+	+	+	+	+	+	+	+	+	+	+	+	+	
Stromal nephroma																										X	
Renal tubule, adenoma													X														
Urinary bladder	+	+	+	+	+	+	+	+	+	+	+	+	+	+	+	+	+	+	+	+	+	+	+	+	+	+	
Systemic Lesions																											
Multiple organs	+	+	+	+	+	+	+	+	+	+	+	+	+	+	+	+	+	+	+	+	+	+	+	+	+	+	
Leukemia mononuclear		X	X	X		X					X		X	X	X		X	X		X	X					X	

TABLE A2
Individual Animal Tumor Pathology of Male Rats in the 2-Year Inhalation Study of Isobutene: 8,000 ppm

Number of Days on Study	6 6 6 6 6 6 6 6 6 6 6 6 6 7 7 7 7 7 7 7 7 7 7 7 7	
	6 6 6 6 7 7 8 8 8 8 9 9 0 0 0 0 2 3 3 3 3 3 3 3 3	
	4 4 6 7 0 8 8 8 8 9 0 2 0 1 1 2 0 3 3 3 3 3 3 3 3	
Carcass ID Number	6 6 6 6 6 6 6 6 6 6 6 6 6 6 6 6 6 6 6 6 6 6 6 6 6	Total Tissues/ Tumors
	0 3 1 1 1 2 0 1 2 2 3 4 5 1 3 4 4 0 0 2 2 2 3 3 4	
	5 0 5 0 1 9 4 3 0 4 6 7 0 2 7 1 3 7 8 2 3 5 3 4 0	
Genital System (continued)		
Testes	+ + + + + + + + + + + + + + + + + + + + + + + + +	50
Bilateral, interstitial cell, adenoma	X X X X X X X X	14
Interstitial cell, adenoma	X X X X X X X	11
Hematopoietic System		
Bone marrow	+ + + + + + + + + + + + + + + + + + + + + + + + +	50
Lymph node		10
Lymph node, bronchial	+ M + + + + + + + + + + + + + + + + + + + + + + + + +	45
Lymph node, mandibular	+ + + + + + + + + + + + + + + + + + + + + + + + + + +	49
Lymph node, mesenteric	+ + + + + + + + + + + + + + + + + + + + + + + + + + +	50
Lymph node, mediastinal	+ M + + + + + + + + + + + + + + + + + + + + + + + + +	45
Carcinoma, metastatic, thyroid gland		1
Spleen	+ + + + + + + + + + + + + + + + + + + + + + + + + + +	50
Thymus	M + + + + + M + + + + + + + + + + + + + + + + + + + + +	42
Integumentary System		
Mammary gland	+ + + + + + + + + + + + + + M + + M + + M + + + M + +	44
Fibroadenoma		1
Skin	+ + + + + + + + + + + + + + + + + + + + + + + + + + +	50
Basal cell adenoma		2
Keratoacanthoma	X X	
Squamous cell papilloma	X X X X	4
Subcutaneous tissue, rhabdomyosarcoma	X	1
Musculoskeletal System		
Bone	+ + + + + + + + + + + + + + + + + + + + + + + + + + +	50
Skeletal muscle		1
Nervous System		
Brain	+ + + + + + + + + + + + + + + + + + + + + + + + + + +	50
Respiratory System		
Larynx	+ + + + + + + + + + + + + + + + + + + + + + + +	49
Lung	+ + + + + + + + + + + + + + + + + + + + + + + + + + + +	50
Alveolar/bronchiolar carcinoma		1
Carcinoma, metastatic, thyroid gland		1
Nose	+ + + + + + + + + + + + + + + + + + + + + + + + + + +	49
Trachea	+ + + + + + + + + + + + + + + + + + + + + + + + + + +	50
Special Senses System		
None		
Urinary System		
Kidney	+ + + + + + + + + + + + + + + + + + + + + + + + + + +	50
Stromal nephroma		1
Renal tubule, adenoma		2
Urinary bladder	+ + + + + + + + + + + + + + + + + + + + + + + + + + +	50
Systemic Lesions		
Multiple organs	+ + + + + + + + + + + + + + + + + + + + + + + + + + +	50
Leukemia mononuclear	X X X X X X X X X X X X X X X X X X X	31

TABLE A3
Statistical Analysis of Primary Neoplasms in Male Rats in the 2-Year Inhalation Study of Isobutene

	Chamber Control	500 ppm	2,000 ppm	8,000 ppm
Adrenal Medulla: Benign Pheochromocytoma				
Overall rate ^a	23/50 (46%)	18/49 (37%)	16/50 (32%)	23/50 (46%)
Adjusted rate ^b	60.0%	52.1%	46.2%	56.9%
Terminal rate ^c	6/7 (86%)	4/5 (80%)	4/6 (67%)	6/8 (75%)
First incidence (days)	539	526	496	525
Poly-3 test ^d	P= 0.497	P= 0.309N	P= 0.146N	P= 0.476N
Adrenal Medulla: Malignant Pheochromocytoma				
Overall rate	0/50 (0%)	1/49 (2%)	1/50 (2%)	3/50 (6%)
Adjusted rate	0.0%	3.2%	3.2%	8.3%
Terminal rate	0/7 (0%)	0/5 (0%)	0/6 (0%)	1/8 (13%)
First incidence (days)	— ^e	664	453	631
Poly-3 test	P= 0.085	P= 0.485	P= 0.489	P= 0.132
Adrenal Medulla: Benign or Malignant Pheochromocytoma				
Overall rate	23/50 (46%)	18/49 (37%)	17/50 (34%)	24/50 (48%)
Adjusted rate	60.0%	52.1%	48.0%	59.1%
Terminal rate	6/7 (86%)	4/5 (80%)	4/6 (67%)	6/8 (75%)
First incidence (days)	539	526	453	525
Poly-3 test	P= 0.399	P= 0.309N	P= 0.187N	P= 0.564N
Lung: Alveolar/bronchiolar Adenoma or Carcinoma				
Overall rate	2/50 (4%)	4/50 (8%)	3/50 (6%)	1/50 (2%)
Adjusted rate	5.9%	12.6%	9.5%	2.8%
Terminal rate	0/7 (0%)	1/5 (20%)	0/6 (0%)	1/8 (13%)
First incidence (days)	580	579	607	733 (T)
Poly-3 test	P= 0.196N	P= 0.301	P= 0.466	P= 0.482N
Pancreatic Islets: Adenoma				
Overall rate	4/50 (8%)	0/49 (0%)	1/50 (2%)	4/50 (8%)
Adjusted rate	11.8%	0.0%	3.2%	10.8%
Terminal rate	1/7 (14%)	0/5 (0%)	0/6 (0%)	0/8 (0%)
First incidence (days)	666	—	714	618
Poly-3 test	P= 0.276	P= 0.071N	P= 0.203N	P= 0.599N
Pancreatic Islets: Carcinoma				
Overall rate	4/50 (8%)	2/49 (4%)	1/50 (2%)	4/50 (8%)
Adjusted rate	11.6%	6.4%	3.2%	10.8%
Terminal rate	1/7 (14%)	0/5 (0%)	0/6 (0%)	0/8 (0%)
First incidence (days)	477	664	620	534
Poly-3 test	P= 0.451	P= 0.383N	P= 0.206N	P= 0.609N
Pancreatic Islets: Adenoma or Carcinoma				
Overall rate	8/50 (16%)	2/49 (4%)	2/50 (4%)	8/50 (16%)
Adjusted rate	22.8%	6.4%	6.4%	21.0%
Terminal rate	2/7 (29%)	0/5 (0%)	0/6 (0%)	0/8 (0%)
First incidence (days)	477	664	620	534
Poly-3 test	P= 0.238	P= 0.060N	P= 0.058N	P= 0.540N
Pituitary Gland (Pars Distalis): Adenoma				
Overall rate	43/50 (86%)	40/49 (82%)	40/50 (80%)	41/49 (84%)
Adjusted rate	93.0%	89.2%	87.1%	86.9%
Terminal rate	6/7 (86%)	3/5 (60%)	5/6 (83%)	6/8 (75%)
First incidence (days)	476	460	453	490
Poly-3 test	P= 0.280N	P= 0.377N	P= 0.240N	P= 0.233N

TABLE A3
Statistical Analysis of Primary Neoplasms in Male Rats in the 2-Year Inhalation Study of Isobutene

	Chamber Control	500 ppm	2,000 ppm	8,000 ppm
Preputial Gland: Adenoma				
Overall rate	4/50 (8%)	2/50 (4%)	2/49 (4%)	1/50 (2%)
Adjusted rate	11.4%	6.4%	6.4%	2.8%
Terminal rate	1/7 (14%)	1/5 (20%)	0/6 (0%)	0/8 (0%)
First incidence (days)	467	583	628	700
Poly-3 test	P= 0.170N	P= 0.386N	P= 0.390N	P= 0.167N
Preputial Gland: Carcinoma				
Overall rate	1/50 (2%)	3/50 (6%)	2/49 (4%)	3/50 (6%)
Adjusted rate	2.9%	9.4%	6.3%	8.2%
Terminal rate	0/7 (0%)	0/5 (0%)	0/6 (0%)	0/8 (0%)
First incidence (days)	560	526	520	540
Poly-3 test	P= 0.431	P= 0.278	P= 0.474	P= 0.331
Preputial Gland: Adenoma or Carcinoma				
Overall rate	5/50 (10%)	5/50 (10%)	4/49 (8%)	4/50 (8%)
Adjusted rate	14.1%	15.5%	12.4%	10.9%
Terminal rate	1/7 (14%)	1/5 (20%)	0/6 (0%)	0/8 (0%)
First incidence (days)	467	526	520	540
Poly-3 test	P= 0.383N	P= 0.572	P= 0.562N	P= 0.477N
Skin: Keratoacanthoma				
Overall rate	3/50 (6%)	4/50 (8%)	2/50 (4%)	4/50 (8%)
Adjusted rate	8.8%	12.5%	6.4%	11.1%
Terminal rate	1/7 (14%)	1/5 (20%)	1/6 (17%)	2/8 (25%)
First incidence (days)	621	552	574	700
Poly-3 test	P= 0.523	P= 0.463	P= 0.538N	P= 0.530
Skin: Squamous Cell Papilloma or Keratoacanthoma				
Overall rate	3/50 (6%)	5/50 (10%)	3/50 (6%)	5/50 (10%)
Adjusted rate	8.8%	15.6%	9.5%	13.9%
Terminal rate	1/7 (14%)	1/5 (20%)	1/6 (17%)	3/8 (38%)
First incidence (days)	621	552	574	700
Poly-3 test	P= 0.442	P= 0.318	P= 0.631	P= 0.384
Skin: Squamous Cell Papilloma, Keratoacanthoma, Basal Cell Adenoma, or Basal Cell Carcinoma				
Overall rate	3/50 (6%)	7/50 (14%)	3/50 (6%)	7/50 (14%)
Adjusted rate	8.8%	21.5%	9.5%	19.2%
Terminal rate	1/7 (14%)	2/5 (40%)	1/6 (17%)	3/8 (38%)
First incidence (days)	621	552	574	688
Poly-3 test	P= 0.275	P= 0.128	P= 0.631	P= 0.176
Testes: Adenoma				
Overall rate	23/50 (46%)	28/50 (56%)	29/50 (58%)	25/50 (50%)
Adjusted rate	59.1%	70.4%	74.2%	61.1%
Terminal rate	5/7 (71%)	3/5 (60%)	6/6 (100%)	6/8 (75%)
First incidence (days)	379	460	496	583
Poly-3 test	P= 0.343N	P= 0.180	P= 0.087	P= 0.522
Thyroid Gland (C-cell): Adenoma				
Overall rate	5/48 (10%)	4/48 (8%)	5/48 (10%)	7/50 (14%)
Adjusted rate	14.8%	12.8%	16.5%	18.3%
Terminal rate	2/7 (29%)	0/5 (0%)	1/6 (17%)	0/8 (0%)
First incidence (days)	540	583	678	534
Poly-3 test	P= 0.360	P= 0.549N	P= 0.563	P= 0.468

TABLE A3
Statistical Analysis of Primary Neoplasms in Male Rats in the 2-Year Inhalation Study of Isobutene

	Chamber Control	500 ppm	2,000 ppm	8,000 ppm
Thyroid Gland (C-cell): Adenoma or Carcinoma				
Overall rate	5/48 (10%)	4/48 (8%)	7/48 (15%)	8/50 (16%)
Adjusted rate	14.8%	12.8%	22.7%	20.7%
Terminal rate	2/7 (29%)	0/5 (0%)	2/6 (33%)	0/8 (0%)
First incidence (days)	540	583	520	534
Poly-3 test	P= 0.290	P= 0.549N	P= 0.310	P= 0.365
Thyroid Gland (Follicular Cell): Carcinoma				
Overall rate	1/48 (2%)	0/48 (0%)	0/48 (0%)	5/50 (10%)
Adjusted rate	3.0%	0.0%	0.0%	13.5%
Terminal rate	0/7 (0%)	0/5 (0%)	0/6 (0%)	0/8 (0%)
First incidence (days)	661	—	—	618
Poly-3 test	P= 0.004	P= 0.519N	P= 0.521N	P= 0.125
All Organs: Malignant Mesothelioma				
Overall rate	3/50 (6%)	2/50 (4%)	0/50 (0%)	0/50 (0%)
Adjusted rate	8.7%	6.3%	0.0%	0.0%
Terminal rate	0/7 (0%)	0/5 (0%)	0/6 (0%)	0/8 (0%)
First incidence (days)	544	547	—	—
Poly-3 test	P= 0.081N	P= 0.540N	P= 0.138N	P= 0.110N
All Organs: Mononuclear Cell Leukemia				
Overall rate	21/50 (42%)	21/50 (42%)	20/50 (40%)	31/50 (62%)
Adjusted rate	54.9%	55.5%	52.4%	71.1%
Terminal rate	6/7 (86%)	4/5 (80%)	2/6 (33%)	7/8 (88%)
First incidence (days)	467	514	497	505
Poly-3 test	P= 0.028	P= 0.575	P= 0.504N	P= 0.075
All Organs: Benign Neoplasms				
Overall rate	48/50 (96%)	46/50 (92%)	49/50 (98%)	49/50 (98%)
Adjusted rate	98.3%	98.3%	99.8%	98.4%
Terminal rate	7/7 (100%)	5/5 (100%)	6/6 (100%)	8/8 (100%)
First incidence (days)	379	460	453	490
Poly-3 test	P= 0.793N	P= 0.898	P= 0.659	P= 0.821
All Organs: Malignant Neoplasms				
Overall rate	31/50 (62%)	33/50 (66%)	28/50 (56%)	40/50 (80%)
Adjusted rate	72.1%	78.4%	68.5%	87.1%
Terminal rate	7/7 (100%)	5/5 (100%)	5/6 (83%)	7/8 (88%)
First incidence (days)	379	469	453	505
Poly-3 test	P= 0.030	P= 0.314	P= 0.445N	P= 0.040

TABLE A3
Statistical Analysis of Primary Neoplasms in Male Rats in the 2-Year Inhalation Study of Isobutene

	Chamber Control	500 ppm	2,000 ppm	8,000 ppm
All Organs: Benign or Malignant Neoplasms				
Overall rate	50/50 (100%)	48/50 (96%)	49/50 (98%)	50/50 (100%)
Adjusted rate	100.0%	99.6%	99.8%	100.0%
Terminal rate	7/7 (100%)	5/5 (100%)	6/6 (100%)	8/8 (100%)
First incidence (days)	379	460	453	490
Poly-3 test	P= 1.000	P= 1.000N	P= 1.000N	— ^f

(T)Terminal sacrifice

^a Number of neoplasm-bearing animals/number of animals examined. Denominator is number of animals examined microscopically for adrenal gland, lung, pancreatic islets, pituitary gland, preputial gland, testes, and thyroid gland; for other tissues, denominator is number of animals necropsied.

^b Poly-3 estimated neoplasm incidence after adjustment for intercurrent mortality

^c Observed incidence at terminal kill

^d Beneath the chamber control incidence are the P values associated with the trend test. Beneath the exposed group incidence are the P values corresponding to pairwise comparisons between the chamber controls and that exposed group. The Poly-3 test accounts for differential mortality in animals that do not reach terminal sacrifice. A negative trend or a lower incidence in an exposure group is indicated by N.

^e Not applicable; no neoplasms in animal group

^f Value of statistic cannot be computed.

TABLE A4
Historical Incidence of Thyroid Gland Follicular Cell Neoplasms in Chamber Control Male F344/N Rats^a

Study	Incidence in Controls		
	Adenoma	Carcinoma	Adenoma or Carcinoma
Historical Incidence at Battelle Pacific Northwest Laboratories			
Acetonitrile	0/48	0/48	0/48
2-Chloroacetophenone	1/45	0/45	1/45
Cobalt Sulfate Heptahydrate	0/49	1/49	1/49
<i>l</i> -Epinephrine Hydrochloride	0/50	2/50	2/50
Hexachlorocyclopentadiene	0/49	0/49	0/49
Isobutyraldehyde	0/50	0/50	0/50
Molybdenum Trioxide	1/50	0/50	1/50
Nitromethane	0/50	1/50	1/50
<i>o</i> -Chlorobenzalmalonitrile (CS-2)	0/48	0/48	0/48
Ozone	0/49	1/49	1/49
Tetrafluoroethylene	1/50	0/50	1/50
Tetrahydrofuran	2/50	1/50	3/50
Overall Historical Incidence			
Total	7/892 (0.8%)	9/892 (1.0%)	16/892 (1.8%)
Standard deviation	1.2%	1.2%	1.7%
Range	0%-4%	0%-4%	0%-6%

^a Data as of 15 October 1996

TABLE A5
Summary of the Incidence of Nonneoplastic Lesions in Male Rats in the 2-Year Inhalation Study of Isobutene^a

	Chamber Control	500 ppm	2,000 ppm	8,000 ppm
Disposition Summary				
Animals initially in study	50	50	50	50
Early deaths				
Moribund	39	40	37	41
Natural deaths	4	5	7	1
Survivors				
Terminal sacrifice	7	5	6	8
Animals examined microscopically	50	50	50	50
Alimentary System				
Esophagus	(50)	(50)	(50)	(50)
Inflammation, suppurative	1 (2%)	1 (2%)	2 (4%)	
Intestine large, colon	(49)	(48)	(48)	(49)
Diverticulum			1 (2%)	
Mineralization				1 (2%)
Parasite metazoan	4 (8%)	1 (2%)	2 (4%)	2 (4%)
Intestine large, rectum	(47)	(49)	(49)	(49)
Necrosis			1 (2%)	
Parasite metazoan		2 (4%)	3 (6%)	3 (6%)
Intestine large, cecum	(48)	(47)	(49)	(49)
Inflammation, acute				1 (2%)
Necrosis			2 (4%)	1 (2%)
Parasite metazoan	3 (6%)	2 (4%)	6 (12%)	4 (8%)
Intestine small, duodenum	(49)	(49)	(50)	(49)
Necrosis	2 (4%)		2 (4%)	
Liver	(50)	(50)	(50)	(50)
Angiectasis	3 (6%)	1 (2%)		1 (2%)
Basophilic focus	17 (34%)	14 (28%)	14 (28%)	22 (44%)
Clear cell focus	3 (6%)	1 (2%)	3 (6%)	3 (6%)
Cyst				2 (4%)
Degeneration, cystic	13 (26%)	10 (20%)	14 (28%)	16 (32%)
Degeneration, fatty	14 (28%)	18 (36%)	18 (36%)	14 (28%)
Eosinophilic focus	6 (12%)	2 (4%)	5 (10%)	5 (10%)
Hepatodiaphragmatic nodule	4 (8%)	2 (4%)	1 (2%)	2 (4%)
Inflammation, granulomatous			1 (2%)	
Mineralization			1 (2%)	1 (2%)
Mixed cell focus	3 (6%)	2 (4%)	4 (8%)	
Necrosis		2 (4%)	3 (6%)	1 (2%)
Regeneration				2 (4%)
Thrombosis	2 (4%)			
Vacuolization cytoplasmic, focal			1 (2%)	
Bile duct, hyperplasia	23 (46%)	27 (54%)	23 (46%)	29 (58%)
Centrilobular, necrosis	10 (20%)	9 (18%)	10 (20%)	15 (30%)
Mesentery	(15)	(10)	(8)	(11)
Mineralization	1 (7%)			
Pigmentation	1 (7%)			
Artery, inflammation, chronic active		1 (10%)		1 (9%)
Artery, mineralization	1 (7%)	1 (10%)		1 (9%)
Fat, hemorrhage		1 (10%)		1 (9%)
Fat, necrosis	14 (93%)	9 (90%)	8 (100%)	8 (73%)

^a Number of animals examined microscopically at the site and the number of animals with lesion

TABLE A5
Summary of the Incidence of Nonneoplastic Lesions in Male Rats in the 2-Year Inhalation Study of Isobutene

	Chamber Control	500 ppm	2,000 ppm	8,000 ppm
Alimentary System (continued)				
Pancreas	(50)	(50)	(50)	(50)
Atrophy	22 (44%)	17 (34%)	26 (52%)	18 (36%)
Basophilic focus	1 (2%)	1 (2%)	1 (2%)	2 (4%)
Hyperplasia	4 (8%)	3 (6%)	4 (8%)	3 (6%)
Artery, inflammation				1 (2%)
Artery, mineralization			1 (2%)	1 (2%)
Salivary glands	(50)	(50)	(50)	(50)
Artery, mineralization		1 (2%)		
Stomach, forestomach	(50)	(50)	(50)	(50)
Inflammation, chronic				1 (2%)
Mineralization	1 (2%)	1 (2%)	1 (2%)	1 (2%)
Necrosis	17 (34%)	16 (32%)	19 (38%)	10 (20%)
Perforation			1 (2%)	
Stomach, glandular	(50)	(49)	(50)	(50)
Mineralization	3 (6%)	3 (6%)	5 (10%)	4 (8%)
Necrosis	8 (16%)	5 (10%)	11 (22%)	9 (18%)
Tongue	(1)			(1)
Necrosis	1 (100%)			
Tooth	(2)	(3)	(1)	(1)
Developmental malformation	2 (100%)	1 (33%)		1 (100%)
Inflammation, chronic active		2 (67%)	1 (100%)	
Necrosis		1 (33%)		
Cardiovascular System				
Blood vessel	(2)	(2)	(2)	(2)
Aorta, mineralization	2 (100%)	2 (100%)	2 (100%)	2 (100%)
Heart	(50)	(50)	(50)	(50)
Cardiomyopathy	39 (78%)	39 (78%)	41 (82%)	41 (82%)
Artery, mineralization	3 (6%)	4 (8%)	4 (8%)	5 (10%)
Atrium, thrombosis		1 (2%)	3 (6%)	6 (12%)
Endocrine System				
Adrenal cortex	(50)	(49)	(50)	(50)
Atrophy	1 (2%)			
Degeneration, cystic				1 (2%)
Hyperplasia	21 (42%)	23 (47%)	24 (48%)	23 (46%)
Hypertrophy	7 (14%)	6 (12%)	7 (14%)	4 (8%)
Necrosis		1 (2%)	1 (2%)	
Vacuolization cytoplasmic		1 (2%)	3 (6%)	
Adrenal medulla	(50)	(49)	(50)	(50)
Atrophy	1 (2%)			
Hyperplasia	14 (28%)	18 (37%)	28 (56%)	15 (30%)
Bilateral, hyperplasia	1 (2%)	1 (2%)	2 (4%)	3 (6%)
Islets, pancreatic	(50)	(49)	(50)	(50)
Hyperplasia		4 (8%)	3 (6%)	3 (6%)
Parathyroid gland	(49)	(50)	(49)	(47)
Hyperplasia	9 (18%)	11 (22%)	12 (24%)	10 (21%)
Pituitary gland	(50)	(49)	(50)	(49)
Angiectasis	1 (2%)			
Pars distalis, hyperplasia	5 (10%)	5 (10%)	3 (6%)	6 (12%)
Pars distalis, thrombosis	1 (2%)			
Thyroid gland	(48)	(48)	(48)	(50)
C-cell, hyperplasia	32 (67%)	36 (75%)	34 (71%)	26 (52%)
Follicular cell, hyperplasia		2 (4%)		1 (2%)

TABLE A5
Summary of the Incidence of Nonneoplastic Lesions in Male Rats in the 2-Year Inhalation Study of Isobutene

	Chamber Control	500 ppm	2,000 ppm	8,000 ppm
General Body System				
None				
Genital System				
Epididymis	(50)	(50)	(50)	(50)
Granuloma sperm			1 (2%)	
Preputial gland	(50)	(50)	(49)	(50)
Hyperplasia	2 (4%)	1 (2%)	2 (4%)	1 (2%)
Inflammation, acute		1 (2%)		
Inflammation, chronic active	3 (6%)	3 (6%)		2 (4%)
Prostate	(50)	(49)	(50)	(50)
Hyperplasia	6 (12%)	6 (12%)	6 (12%)	7 (14%)
Inflammation, chronic active	4 (8%)	4 (8%)	4 (8%)	6 (12%)
Seminal vesicle	(50)	(47)	(50)	(50)
Inflammation, chronic active	1 (2%)		1 (2%)	
Mineralization		1 (2%)	1 (2%)	1 (2%)
Testes	(50)	(50)	(50)	(50)
Atrophy	7 (14%)		3 (6%)	5 (10%)
Necrosis		3 (6%)		1 (2%)
Artery, inflammation, chronic active	4 (8%)	2 (4%)	1 (2%)	3 (6%)
Artery, mineralization				1 (2%)
Interstitial cell, hyperplasia	4 (8%)	4 (8%)	4 (8%)	2 (4%)
Hematopoietic System				
Bone marrow	(50)	(48)	(50)	(50)
Necrosis				1 (2%)
Lymph node	(4)	(11)	(10)	(10)
Hemorrhage	1 (25%)			
Iliac, ectasia			1 (10%)	
Renal, hemorrhage		1 (9%)		
Lymph node, mandibular	(47)	(47)	(49)	(49)
Hemorrhage			1 (2%)	
Infiltration cellular, plasma cell	1 (2%)	1 (2%)		1 (2%)
Infiltration cellular, polymorphonuclear	1 (2%)			
Lymph node, mesenteric	(50)	(50)	(49)	(50)
Ectasia	1 (2%)		1 (2%)	
Lymph node, mediastinal	(46)	(42)	(44)	(45)
Hemorrhage		1 (2%)		
Spleen	(50)	(49)	(50)	(50)
Accessory spleen	1 (2%)		1 (2%)	1 (2%)
Fibrosis	9 (18%)	6 (12%)	10 (20%)	11 (22%)
Hematopoietic cell proliferation	2 (4%)	5 (10%)	4 (8%)	3 (6%)
Hemorrhage	1 (2%)	1 (2%)		1 (2%)
Necrosis			2 (4%)	1 (2%)
Integumentary System				
Mammary gland	(41)	(41)	(40)	(44)
Galactocele	2 (5%)	7 (17%)	1 (3%)	4 (9%)
Hyperplasia, atypical		1 (2%)		
Inflammation, chronic	1 (2%)		1 (3%)	1 (2%)
Skin	(50)	(50)	(50)	(50)
Cyst epithelial inclusion		1 (2%)		
Hyperkeratosis	1 (2%)		1 (2%)	1 (2%)
Inflammation, chronic active	1 (2%)		1 (2%)	5 (10%)

TABLE A5
Summary of the Incidence of Nonneoplastic Lesions in Male Rats in the 2-Year Inhalation Study of Isobutene

	Chamber Control	500 ppm	2,000 ppm	8,000 ppm
Musculoskeletal System				
Bone	(50)	(50)	(50)	(50)
Fibrous osteodystrophy	9 (18%)	7 (14%)	9 (18%)	6 (12%)
Hyperostosis			1 (2%)	1 (2%)
Skeletal muscle	(1)		(1)	(1)
Mineralization				1 (100%)
Nervous System				
Brain	(50)	(50)	(50)	(50)
Angiectasis		1 (2%)		
Hemorrhage			1 (2%)	
Respiratory System				
Larynx	(50)	(49)	(50)	(49)
Necrosis	1 (2%)	1 (2%)		
Epiglottis, metaplasia, squamous				1 (2%)
Lung	(50)	(50)	(50)	(50)
Cyst	1 (2%)			
Hemorrhage	1 (2%)	1 (2%)		1 (2%)
Inflammation, granulomatous	9 (18%)	3 (6%)	1 (2%)	5 (10%)
Inflammation, suppurative	1 (2%)			1 (2%)
Metaplasia, squamous	1 (2%)			
Mineralization	2 (4%)	2 (4%)	1 (2%)	1 (2%)
Alveolar epithelium, hyperplasia	9 (18%)	5 (10%)	7 (14%)	5 (10%)
Alveolus, infiltration cellular, histiocyte			1 (2%)	
Artery, mediastinum, mineralization	2 (4%)	2 (4%)	1 (2%)	1 (2%)
Bronchiole, hyperplasia				1 (2%)
Mediastinum, inflammation, suppurative			1 (2%)	
Nose	(49)	(49)	(50)	(49)
Inflammation, suppurative	14 (29%)	11 (22%)	16 (32%)	9 (18%)
Thrombosis	4 (8%)	7 (14%)	10 (20%)	6 (12%)
Lateral wall, metaplasia, squamous	1 (2%)			
Olfactory epithelium, atrophy	3 (6%)			
Olfactory epithelium, degeneration, hyaline	43 (88%)	45 (92%)	46 (92%)	49 (100%)
Olfactory epithelium, metaplasia	4 (8%)			
Respiratory epithelium, metaplasia, squamous	1 (2%)			
Trachea	(50)	(50)	(50)	(50)
Inflammation, suppurative	2 (4%)			
Special Senses System				
Eye	(3)		(4)	
Cataract	2 (67%)		3 (75%)	
Degeneration	1 (33%)			
Inflammation, chronic active			2 (50%)	
Retina, atrophy	1 (33%)		3 (75%)	

TABLE A5
Summary of the Incidence of Nonneoplastic Lesions in Male Rats in the 2-Year Inhalation Study of Isobutene

	Chamber Control	500 ppm	2,000 ppm	8,000 ppm
Urinary System				
Kidney	(50)	(50)	(50)	(50)
Cyst	3 (6%)	3 (6%)		1 (2%)
Hydronephrosis	1 (2%)			
Hyperplasia, oncocytic	1 (2%)			
Infarct		1 (2%)		1 (2%)
Mineralization	4 (8%)	2 (4%)	3 (6%)	4 (8%)
Nephropathy	50 (100%)	48 (96%)	50 (100%)	50 (100%)
Papilla, necrosis			1 (2%)	
Pelvis, inflammation, acute	1 (2%)	1 (2%)	2 (4%)	1 (2%)
Renal tubule, hyperplasia	2 (4%)	4 (8%)	3 (6%)	4 (8%)
Transitional epithelium, hyperplasia	1 (2%)			2 (4%)
Urinary bladder	(50)	(49)	(50)	(50)
Hemorrhage	1 (2%)		1 (2%)	
Inflammation, chronic active		1 (2%)	3 (6%)	2 (4%)
Inflammation, suppurative	1 (2%)			
Necrosis	1 (2%)			
Transitional epithelium, hyperplasia	1 (2%)	1 (2%)	1 (2%)	3 (6%)

APPENDIX B
SUMMARY OF LESIONS IN FEMALE RATS
IN THE 2-YEAR INHALATION STUDY
OF ISOBUTENE

TABLE B1	Summary of the Incidence of Neoplasms in Female Rats in the 2-Year Inhalation Study of Isobutene	97
TABLE B2	Individual Animal Tumor Pathology of Female Rats in the 2-Year Inhalation Study of Isobutene	100
TABLE B3	Statistical Analysis of Primary Neoplasms in Female Rats in the 2-Year Inhalation Study of Isobutene	118
TABLE B4	Summary of the Incidence of Nonneoplastic Lesions in Female Rats in the 2-Year Inhalation Study of Isobutene	121

TABLE B1
Summary of the Incidence of Neoplasms in Female Rats in the 2-Year Inhalation Study of Isobutene^a

	Chamber Control	500 ppm	2,000 ppm	8,000 ppm
Disposition Summary				
Animals initially in study	50	50	50	50
Early deaths				
Accidental death		1		
Moribund	21	25	15	23
Natural deaths	6	5	2	5
Survivors				
Terminal sacrifice	23	19	33	22
Animals examined microscopically	50	50	50	50
Alimentary System				
Intestine large, colon	(49)	(50)	(49)	(49)
Intestine large, rectum	(47)	(47)	(47)	(48)
Polyp adenomatous	1 (2%)			
Intestine large, cecum	(48)	(49)	(48)	(49)
Intestine small, duodenum	(49)	(50)	(48)	(48)
Intestine small, jejunum	(47)	(47)	(48)	(47)
Leiomyosarcoma			1 (2%)	
Intestine small, ileum	(46)	(47)	(48)	(47)
Liver	(50)	(50)	(50)	(49)
Carcinoma, metastatic, thyroid gland		1 (2%)		
Hepatocellular carcinoma				1 (2%)
Mesentery	(8)	(10)	(12)	(7)
Oral mucosa				(1)
Pharyngeal, squamous cell papilloma				1 (100%)
Pancreas	(50)	(50)	(49)	(49)
Salivary glands	(50)	(50)	(50)	(50)
Stomach, glandular	(50)	(50)	(50)	(49)
Cardiovascular System				
Heart	(50)	(50)	(49)	(50)
Endocrine System				
Adrenal cortex	(50)	(50)	(49)	(49)
Adenoma	1 (2%)	1 (2%)	1 (2%)	1 (2%)
Adrenal medulla	(50)	(50)	(49)	(49)
Pheochromocytoma complex	1 (2%)			
Pheochromocytoma benign	3 (6%)	3 (6%)	9 (18%)	4 (8%)
Bilateral, pheochromocytoma benign			1 (2%)	
Islets, pancreatic	(50)	(50)	(49)	(49)
Adenoma	1 (2%)			
Pituitary gland	(50)	(49)	(50)	(49)
Pars distalis, adenoma	39 (78%)	33 (67%)	37 (74%)	36 (73%)
Thyroid gland	(50)	(50)	(49)	(49)
C-cell, adenoma	7 (14%)	6 (12%)	3 (6%)	5 (10%)
C-cell, carcinoma	2 (4%)	3 (6%)	6 (12%)	2 (4%)
Follicular cell, carcinoma	1 (2%)			
General Body System				
None				

TABLE B1
Summary of the Incidence of Neoplasms in Female Rats in the 2-Year Inhalation Study of Isobutene

	Chamber Control	500 ppm	2,000 ppm	8,000 ppm
Genital System				
Clitoral gland	(50)	(49)	(47)	(48)
Adenoma	3 (6%)	3 (6%)	6 (13%)	
Carcinoma			5 (11%)	1 (2%)
Bilateral, carcinoma	1 (2%)			
Ovary	(50)	(50)	(50)	(50)
Granulosa cell tumor malignant				1 (2%)
Uterus	(50)	(50)	(50)	(50)
Polyp stromal	7 (14%)	9 (18%)	7 (14%)	4 (8%)
Polyp stromal, multiple	1 (2%)		1 (2%)	1 (2%)
Vagina	(1)	(1)		(1)
Polyp	1 (100%)			
Hematopoietic System				
Bone marrow	(50)	(50)	(49)	(49)
Lymph node	(6)	(3)	(3)	(2)
Deep cervical, carcinoma, metastatic, thyroid gland				1 (50%)
Renal, sarcoma	1 (17%)			
Lymph node, bronchial	(36)	(31)	(36)	(27)
Lymph node, mandibular	(44)	(46)	(47)	(47)
Lymph node, mesenteric	(50)	(50)	(49)	(49)
Lymph node, mediastinal	(42)	(45)	(39)	(45)
Plasma cell tumor malignant	1 (2%)			
Spleen	(50)	(50)	(49)	(50)
Hemangiosarcoma				1 (2%)
Thymus	(48)	(47)	(45)	(41)
Integumentary System				
Mammary gland	(50)	(50)	(50)	(50)
Adenoma	1 (2%)	1 (2%)	1 (2%)	
Carcinoma	2 (4%)	2 (4%)	4 (8%)	4 (8%)
Fibroadenoma	16 (32%)	14 (28%)	24 (48%)	22 (44%)
Fibroadenoma, multiple	6 (12%)	5 (10%)	6 (12%)	5 (10%)
Skin	(50)	(50)	(50)	(50)
Keratoacanthoma	1 (2%)		1 (2%)	
Squamous cell papilloma			1 (2%)	
Subcutaneous tissue, fibroma	1 (2%)		1 (2%)	
Subcutaneous tissue, fibrosarcoma		1 (2%)		
Subcutaneous tissue, fibrous histiocytoma malignant	1 (2%)			
Subcutaneous tissue, hemangioma	1 (2%)			
Subcutaneous tissue, melanoma malignant			1 (2%)	
Subcutaneous tissue, sarcoma	1 (2%)	2 (4%)		
Subcutaneous tissue, schwannoma malignant		1 (2%)		
Subcutaneous tissue, pinna, melanoma malignant	1 (2%)			
Musculoskeletal System				
Bone	(50)	(50)	(50)	(50)
Osteosarcoma	1 (2%)			
Sarcoma	1 (2%)			

TABLE B1
Summary of the Incidence of Neoplasms in Female Rats in the 2-Year Inhalation Study of Isobutene

	Chamber Control	500 ppm	2,000 ppm	8,000 ppm
Nervous System				
Brain	(50)	(50)	(50)	(50)
Respiratory System				
Lung	(50)	(50)	(50)	(50)
Adenoma		1 (2%)		
Alveolar/bronchiolar adenoma	2 (4%)			
Carcinoma, metastatic, mammary gland	1 (2%)			
Carcinoma, metastatic, thyroid gland			2 (4%)	1 (2%)
Fibrosarcoma, metastatic, skin		1 (2%)		
Plasma cell tumor malignant, metastatic, lymph node, mediastinal	1 (2%)			
Mediastinum, plasma cell tumor malignant, metastatic, lymph node, mediastinal	1 (2%)			
Nose	(50)	(50)	(50)	(49)
Special Senses System				
Zymbal's gland			(1)	
Carcinoma			1 (100%)	
Urinary System				
Kidney	(50)	(50)	(49)	(49)
Lipoma				1 (2%)
Stromal nephroma		1 (2%)		
Renal tubule, carcinoma	1 (2%)			
Urinary bladder	(50)	(49)	(49)	(49)
Transitional epithelium, papilloma			1 (2%)	
Systemic Lesions				
Multiple organs ^b	(50)	(50)	(50)	(50)
Leukemia mononuclear	18 (36%)	16 (32%)	22 (44%)	17 (34%)
Neoplasm Summary				
Total animals with primary neoplasms ^c	50	48	49	48
Total primary neoplasms	125	102	140	107
Total animals with benign neoplasms	42	45	48	46
Total benign neoplasms	92	76	100	80
Total animals with malignant neoplasms	30	24	30	25
Total malignant neoplasms	33	26	40	27
Total animals with metastatic neoplasms	2	2	2	1
Total metastatic neoplasms	3	2	2	2

^a Number of animals examined microscopically at the site and the number of animals with neoplasm

^b Number of animals with any tissue examined microscopically

^c Primary neoplasms: all neoplasms except metastatic neoplasms

TABLE B2
Individual Animal Tumor Pathology of Female Rats in the 2-Year Inhalation Study of Isobutene: Chamber Control

Number of Days on Study	3	4	4	4	4	4	5	5	5	5	5	6	6	6	6	6	6	6	6	7	7	7	7	7	7	
Carcass ID Number	9	2	4	8	8	9	2	5	5	7	8	0	4	4	4	6	6	7	9	0	0	1	1	2	2	
	0	1	0	8	8	6	9	2	2	3	1	8	2	2	8	3	4	8	1	5	5	4	5	0	0	
Alimentary System																										
Esophagus	+	+	+	+	+	+	+	+	+	+	+	+	+	+	+	+	+	+	+	+	+	+	+	+	+	
Intestine large, colon	+	+	+	+	+	+	+	+	+	+	+	+	+	+	A	+	+	+	+	+	+	+	+	+	+	
Intestine large, rectum	+	+	+	+	+	+	+	+	+	+	+	+	+	+	A	+	+	+	+	+	+	+	+	A	+	
Polyp adenomatous						X																				
Intestine large, cecum	+	+	+	+	+	+	+	+	+	+	+	+	+	+	A	+	+	+	+	+	+	+	A	+	+	
Intestine small, duodenum	+	+	+	+	+	+	+	+	+	+	+	+	+	+	+	+	+	+	+	+	+	+	A	+	+	
Intestine small, jejunum	+	A	+	+	+	+	+	+	+	+	+	+	+	+	A	+	+	+	+	+	+	+	A	+	+	
Intestine small, ileum	+	A	+	+	+	+	+	+	+	+	+	+	+	+	A	+	+	+	+	+	+	A	+	A	+	
Liver	+	+	+	+	+	+	+	+	+	+	+	+	+	+	+	+	+	+	+	+	+	+	+	+	+	
Mesentery						+	+			+								+					+	+		
Pancreas	+	+	+	+	+	+	+	+	+	+	+	+	+	+	+	+	+	+	+	+	+	+	+	+	+	
Salivary glands	+	+	+	+	+	+	+	+	+	+	+	+	+	+	+	+	+	+	+	+	+	+	+	+	+	
Stomach, forestomach	+	+	+	+	+	+	+	+	+	+	+	+	+	+	+	+	+	+	+	+	+	+	+	+	+	
Stomach, glandular	+	+	+	+	+	+	+	+	+	+	+	+	+	+	+	+	+	+	+	+	+	+	+	+	+	
Cardiovascular System																										
Heart	+	+	+	+	+	+	+	+	+	+	+	+	+	+	+	+	+	+	+	+	+	+	+	+	+	
Endocrine System																										
Adrenal cortex	+	+	+	+	+	+	+	+	+	+	+	+	+	+	+	+	+	+	+	+	+	+	+	+	+	
Adenoma																										
Adrenal medulla	+	+	+	+	+	+	+	+	+	+	+	+	+	+	+	+	+	+	+	+	+	+	+	+	+	
Pheochromocytoma complex																										
Pheochromocytoma benign																										
Islets, pancreatic	+	+	+	+	+	+	+	+	+	+	+	+	+	+	+	+	+	+	+	+	+	+	+	+	+	
Adenoma																										
Parathyroid gland	+	+	+	+	+	+	+	+	+	+	+	+	+	+	+	+	+	+	+	+	+	+	+	+	+	
Pituitary gland	+	+	+	+	+	+	+	+	+	+	+	+	+	+	+	+	+	+	+	+	+	+	+	+	+	
Pars distalis, adenoma						X	X			X	X	X	X	X			X	X	X	X	X	X	X	X		
Thyroid gland	+	+	+	+	+	+	+	+	+	+	+	+	+	+	+	+	+	+	+	+	+	+	+	+	+	
C-cell, adenoma																										
C-cell, carcinoma																									X	
Follicular cell, carcinoma																										
General Body System																										
None																										
Genital System																										
Clitoral gland	+	+	+	+	+	+	+	+	+	+	+	+	+	+	+	+	+	+	+	+	+	+	+	+	+	
Adenoma																										
Bilateral, carcinoma																										
Ovary	+	+	+	+	+	+	+	+	+	+	+	+	+	+	+	+	+	+	+	+	+	+	+	+	+	
Uterus	+	+	+	+	+	+	+	+	+	+	+	+	+	+	+	+	+	+	+	+	+	+	+	+	+	
Polyp stromal							X		X	X		X		X											X	
Polyp stromal, multiple																										
Vagina																									+	
Polyp																									X	

+: Tissue examined microscopically
A: Autolysis precludes examination

M: Missing tissue
I: Insufficient tissue

X: Lesion present
Blank: Not examined

TABLE B2
Individual Animal Tumor Pathology of Female Rats in the 2-Year Inhalation Study of Isobutene: Chamber Control

Number of Days on Study	7 7 7 7 7 7 7 7 7 7 7 7 7 7 7 7 7 7 7 7 7 7 7 7	
	2 2 3 3 3 3 3 3 3 3 3 3 3 3 3 3 3 3 3 3 3 3 3 3	
	2 6 3 3 3 3 3 4 4 4 4 4 4 4 4 4 4 4 4 4 5 5 5 5 5	
Carcass ID Number	1 1 1 1 1 1 1 1 1 1 1 1 1 1 1 1 1 1 1 1 1 1 1 1	Total Tissues/ Tumors
	3 3 0 0 0 0 1 1 1 2 2 2 2 2 2 3 3 3 3 3 3 4 4 4 4	
	1 2 1 2 3 9 3 4 8 0 1 3 5 7 0 3 4 5 6 9 0 1 4 8 9	
Urinary System		
Kidney	+ + + + + + + + + + + + + + + + + + + + + + +	50
Renal tubule, carcinoma		1
Urinary bladder	+ + + + + + + + + + + + + + + + + + + + + + +	50
Systemic Lesions		
Multiple organs	+ + + + + + + + + + + + + + + + + + + + + + +	50
Leukemia mononuclear	X X X X X X X X	18

TABLE B2
Individual Animal Tumor Pathology of Female Rats in the 2-Year Inhalation Study of Isobutene: 500 ppm

Number of Days on Study	7 7 7 7 7 7 7 7 7 7 7 7 7 7 7 7 7 7 7 7 7 7																				Total Tissues/Tumors				
	0 1 1 1 1 2 3 3 3 3 3 3 3 3 3 3 3 3 3 3 3 3	8 4 6 8 9 2 3 3 3 3 4 4 4 4 4 4 4 4 4 4 5 5 5 5																							
Carcass ID Number	3 3 3 3 3 3 3 3 3 3 3 3 3 3 3 3 3 3 3 3 3 3 3	0 3 2 3 0 0 0 0 1 1 1 1 2 2 2 2 3 3 3 3 4 4 4 4 5	4 8 7 2 8 3 6 7 0 2 4 5 0 4 5 8 0 1 4 9 3 4 7 9 0																						
Alimentary System																									
Esophagus	+	+	+	+	+	+	+	+	+	+	+	+	+	+	+	+	+	+	+	+	+	+	+	50	
Intestine large, colon	+	+	+	+	+	+	+	+	+	+	+	+	+	+	+	+	+	+	+	+	+	+	+	50	
Intestine large, rectum	+	+	+	+	+	+	+	+	I	+	+	+	+	+	+	+	+	+	+	+	+	+	+	47	
Intestine large, cecum	+	+	+	+	+	+	+	+	+	+	+	+	+	+	+	+	+	+	+	+	+	+	+	49	
Intestine small, duodenum	+	+	+	+	+	+	+	+	+	+	+	+	+	+	+	+	+	+	+	+	+	+	+	50	
Intestine small, jejunum	+	+	+	A	+	+	+	+	+	+	+	+	+	+	+	+	+	+	+	+	+	+	+	47	
Intestine small, ileum	+	+	+	A	+	+	+	+	+	+	+	+	+	+	+	+	+	+	+	+	+	+	+	47	
Liver	+	+	+	+	+	+	+	+	+	+	+	+	+	+	+	+	+	+	+	+	+	+	+	50	
Carcinoma, metastatic, thyroid gland																								1	
Mesentery		+		+	+	+				+												+		10	
Pancreas	+	+	+	+	+	+	+	+	+	+	+	+	+	+	+	+	+	+	+	+	+	+	+	50	
Salivary glands	+	+	+	+	+	+	+	+	+	+	+	+	+	+	+	+	+	+	+	+	+	+	+	50	
Stomach, forestomach	+	+	+	+	+	+	+	+	+	+	+	+	+	+	+	+	+	+	+	+	+	+	+	50	
Stomach, glandular	+	+	+	+	+	+	+	+	+	+	+	+	+	+	+	+	+	+	+	+	+	+	+	50	
Tongue														+										1	
Cardiovascular System																									
Heart	+	+	+	+	+	+	+	+	+	+	+	+	+	+	+	+	+	+	+	+	+	+	+	50	
Endocrine System																									
Adrenal cortex	+	+	+	+	+	+	+	+	+	+	+	+	+	+	+	+	+	+	+	+	+	+	+	50	
Adenoma										X														1	
Adrenal medulla	+	+	+	+	+	+	+	+	+	+	+	+	+	+	+	+	+	+	+	+	+	+	+	50	
Pheochromocytoma benign						X											X						X	3	
Islets, pancreatic	+	+	+	+	+	+	+	+	+	+	+	+	+	+	+	+	+	+	+	+	+	+	+	50	
Parathyroid gland	+	+	+	+	+	+	+	+	+	+	+	+	+	+	+	+	+	+	+	+	+	+	+	48	
Pituitary gland	+	+	+	+	+	+	+	+	+	+	+	+	+	+	+	+	+	+	+	+	+	+	M	+	49
Pars distalis, adenoma		X	X	X	X	X	X	X	X	X		X		X	X	X	X	X		X			X	33	
Thyroid gland	+	+	+	+	+	+	+	+	+	+	+	+	+	+	+	+	+	+	+	+	+	+	+	50	
C-cell, adenoma						X	X		X				X	X	X									6	
C-cell, carcinoma																								3	
General Body System																									
None																									
Genital System																									
Clitoral gland	+	+	+	+	+	+	+	+	+	I	+	+	+	+	+	+	+	+	+	+	+	+	+	49	
Adenoma								X								X	X							3	
Ovary	+	+	+	+	+	+	+	+	+	+	+	+	+	+	+	+	+	+	+	+	+	+	+	50	
Uterus	+	+	+	+	+	+	+	+	+	+	+	+	+	+	+	+	+	+	+	+	+	+	+	50	
Polyp stromal									X							X		X	X					9	
Vagina																								1	
Hematopoietic System																									
Bone marrow	+	+	+	+	+	+	+	+	+	+	+	+	+	+	+	+	+	+	+	+	+	+	+	50	
Lymph node											+											+		3	
Lymph node, bronchial	+	M	+	+	+	+	+	+	M	M	+	M	+	M	+	+	+	+	+	+	+	+	+	31	
Lymph node, mandibular	+	+	+	+	+	+	+	+	M	+	+	+	M	+	+	+	+	+	+	+	+	+	+	46	
Lymph node, mesenteric	+	+	+	+	+	+	+	+	+	+	+	+	+	+	+	+	+	+	+	+	+	+	+	50	
Lymph node, mediastinal	+	+	+	+	M	+	+	+	+	+	+	+	M	+	+	+	+	+	+	+	+	+	+	45	
Spleen	+	+	+	+	+	+	+	+	+	+	+	+	+	+	+	+	+	+	+	+	+	+	+	50	
Thymus	+	+	+	+	+	+	+	+	+	+	+	+	+	+	+	+	+	+	+	+	M	+	+	47	

TABLE B2
Individual Animal Tumor Pathology of Female Rats in the 2-Year Inhalation Study of Isobutene: 500 ppm

Number of Days on Study	0	2	4	4	4	4	4	4	4	5	5	5	5	5	5	6	6	6	6	6	6	6	6	6	6	6	7
	1	1	2	4	5	7	9	9	3	3	4	6	7	8	0	0	2	3	3	6	6	8	8	9	0		
	3	6	0	0	5	9	4	6	4	4	8	5	3	0	3	8	1	0	5	2	4	8	8	2	1		
Carcass ID Number	3	3	3	3	3	3	3	3	3	3	3	3	3	3	3	3	3	3	3	3	3	3	3	3	3	3	3
	0	4	4	1	4	4	1	0	2	3	0	1	3	2	1	1	4	3	4	0	2	1	2	2	3		
	5	2	5	1	8	6	8	1	6	6	2	6	3	9	7	3	0	5	1	9	3	9	2	1	7		
Integumentary System																											
Mammary gland	+	+	+	+	+	+	+	+	+	+	+	+	+	+	+	+	+	+	+	+	+	+	+	+	+	+	+
Adenoma																											
Carcinoma																											
Fibroadenoma					X			X	X			X			X	X	X	X			X	X					
Fibroadenoma, multiple																											
Skin	+	+	+	+	+	+	+	+	+	+	+	+	+	+	+	+	+	+	+	+	+	+	+	+	+	+	+
Subcutaneous tissue, fibrosarcoma																											
Subcutaneous tissue, sarcoma											X																
Subcutaneous tissue, schwannoma malignant			X																								
Musculoskeletal System																											
Bone	+	+	+	+	+	+	+	+	+	+	+	+	+	+	+	+	+	+	+	+	+	+	+	+	+	+	+
Nervous System																											
Brain	+	+	+	+	+	+	+	+	+	+	+	+	+	+	+	+	+	+	+	+	+	+	+	+	+	+	+
Respiratory System																											
Larynx	+	+	+	+	+	+	+	+	+	+	+	+	+	+	+	+	+	+	+	+	+	+	+	+	+	+	+
Lung	+	+	+	+	+	+	+	+	+	+	+	+	+	+	+	+	+	+	+	+	+	+	+	+	+	+	+
Adenoma																											
Fibrosarcoma, metastatic, skin																											
Nose	+	+	+	+	+	+	+	+	+	+	+	+	+	+	+	+	+	+	+	+	+	+	+	+	+	+	+
Trachea	+	+	+	+	+	+	+	+	+	+	+	+	+	+	+	+	+	+	+	+	+	+	+	+	+	+	+
Special Senses System																											
Ear																											
Eye				+								+	+									+					
Urinary System																											
Kidney	+	+	+	+	+	+	+	+	+	+	+	+	+	+	+	+	+	+	+	+	+	+	+	+	+	+	+
Stromal nephroma																										X	
Urinary bladder	+	+	+	+	+	+	+	+	+	+	+	+	+	+	+	+	+	+	+	+	+	+	+	+	+	+	+
Systemic Lesions																											
Multiple organs	+	+	+	+	+	+	+	+	+	+	+	+	+	+	+	+	+	+	+	+	+	+	+	+	+	+	+
Leukemia mononuclear			X				X				X				X		X	X		X	X		X	X			

TABLE B2
Individual Animal Tumor Pathology of Female Rats in the 2-Year Inhalation Study of Isobutene: 500 ppm

Number of Days on Study	7 7 7 7 7 7 7 7 7 7 7 7 7 7 7 7 7 7 7 7 7 7 7 7	
	0 1 1 1 1 2 3 3 3 3 3 3 3 3 3 3 3 3 3 3 3 3 3 3	
	8 4 6 8 9 2 3 3 3 3 4 4 4 4 4 4 4 4 4 4 4 5 5 5 5	
Carcass ID Number	3 3 3 3 3 3 3 3 3 3 3 3 3 3 3 3 3 3 3 3 3 3 3 3	Total Tissues/ Tumors
	0 3 2 3 0 0 0 0 1 1 1 1 2 2 2 2 3 3 3 3 4 4 4 4 5	
	4 8 7 2 8 3 6 7 0 2 4 5 0 4 5 8 0 1 4 9 3 4 7 9 0	
Integumentary System		
Mammary gland	+ + + + + + + + + + + + + + + + + + + + + + + + + + +	50
Adenoma		1
Carcinoma		2
Fibroadenoma	X	14
Fibroadenoma, multiple		5
Skin	+ + + + + + + + + + + + + + + + + + + + + + + + + + +	50
Subcutaneous tissue, fibrosarcoma		1
Subcutaneous tissue, sarcoma	X	2
Subcutaneous tissue, schwannoma malignant		1
Musculoskeletal System		
Bone	+ + + + + + + + + + + + + + + + + + + + + + + + + + +	50
Nervous System		
Brain	+ + + + + + + + + + + + + + + + + + + + + + + + + + +	50
Respiratory System		
Larynx	+ + + + + + + + + + + + + + + + + + + + + + + + + + +	50
Lung	+ + + + + + + + + + + + + + + + + + + + + + + + + + +	50
Adenoma		1
Fibrosarcoma, metastatic, skin		1
Nose	+ + + + + + + + + + + + + + + + + + + + + + + + + + +	50
Trachea	+ + + + + + + + + + + + + + + + + + + + + + + + + + +	50
Special Senses System		
Ear		1
Eye	+	4
Urinary System		
Kidney	+ + + + + + + + + + + + + + + + + + + + + + + + + + +	50
Stromal nephroma		1
Urinary bladder	+ + + + + + + + + + + + + + + + + + + + + + + + + + +	49
Systemic Lesions		
Multiple organs	+ + + + + + + + + + + + + + + + + + + + + + + + + + +	50
Leukemia mononuclear		16

TABLE B2
Individual Animal Tumor Pathology of Female Rats in the 2-Year Inhalation Study of Isobutene: 2,000 ppm

Number of Days on Study	3	5	5	5	5	6	6	6	6	6	6	6	6	6	7	7	7	7	7	7	7	7	7	7	7	7	7	
Carcass ID Number	3	0	5	4	4	2	2	2	3	4	3	3	4	0	2	0	4	0	0	0	0	0	0	0	1	1	1	
	9	2	4	2	0	7	0	6	4	1	0	4	6	1	5	6	0	3	3	3	3	3	3	4	4	4		
Alimentary System																												
Esophagus	+	+	+	+	+	+	+	+	+	+	+	+	+	+	+	+	+	+	+	+	+	+	+	+	+	+	+	
Intestine large, colon	+	+	+	+	+	+	+	+	+	+	+	+	+	+	+	A	+	+	+	+	+	+	+	+	+	+	+	
Intestine large, rectum	+	+	+	+	+	+	+	+	+	+	+	+	+	+	+	+	+	+	+	+	+	+	+	+	+	+	+	
Intestine large, cecum	+	+	+	+	+	A	+	+	+	+	+	+	+	+	+	A	+	+	+	+	+	+	+	+	+	+	+	
Intestine small, duodenum	+	+	+	+	+	A	+	+	+	+	+	+	+	+	+	A	+	+	+	+	+	+	+	+	+	+	+	
Intestine small, jejunum	+	+	+	+	+	+	M	+	+	+	+	+	+	+	+	A	+	+	+	+	+	+	+	+	+	+	+	
Leiomyosarcoma																												
Intestine small, ileum	+	+	+	+	+	+	A	+	+	+	+	+	+	+	+	A	+	+	+	+	+	+	+	+	+	+	+	
Liver	+	+	+	+	+	+	+	+	+	+	+	+	+	+	+	+	+	+	+	+	+	+	+	+	+	+	+	
Mesentery			+			+	+	+			+		+							+								
Pancreas	+	+	+	+	+	+	+	+	+	+	+	+	+	+	+	A	+	+	+	+	+	+	+	+	+	+	+	
Salivary glands	+	+	+	+	+	+	+	+	+	+	+	+	+	+	+	+	+	+	+	+	+	+	+	+	+	+	+	
Stomach, forestomach	+	+	+	+	+	+	+	+	+	+	+	+	+	+	+	+	+	+	+	+	+	+	+	+	+	+	+	
Stomach, glandular	+	+	+	+	+	+	+	+	+	+	+	+	+	+	+	+	+	+	+	+	+	+	+	+	+	+	+	
Tooth												+																
Cardiovascular System																												
Heart	+	+	+	+	+	+	+	+	+	+	+	+	+	+	+	A	+	+	+	+	+	+	+	+	+	+	+	
Endocrine System																												
Adrenal cortex	+	+	+	+	+	+	+	+	+	+	+	+	+	+	+	A	+	+	+	+	+	+	+	+	+	+	+	
Adenoma																												
Adrenal medulla	+	+	+	+	+	+	+	+	+	+	+	+	+	+	+	A	+	+	+	+	+	+	+	+	+	+	+	
Pheochromocytoma benign								X		X			X										X	X				
Bilateral, pheochromocytoma benign																												
Islets, pancreatic	+	+	+	+	+	+	+	+	+	+	+	+	+	+	+	A	+	+	+	+	+	+	+	+	+	+	+	
Parathyroid gland	+	+	+	+	+	+	+	+	+	+	+	+	+	+	+	A	+	+	+	+	+	+	+	+	+	+	+	
Pituitary gland	+	+	+	+	+	+	+	+	+	+	+	+	+	+	+	+	+	+	+	+	+	+	+	+	+	+	+	
Pars distalis, adenoma	X	X	X		X		X	X		X	X	X	X	X	X					X	X	X		X	X	X	X	
Thyroid gland	+	+	+	+	+	+	+	+	+	+	+	+	+	+	+	A	+	+	+	+	+	+	+	+	+	+	+	
C-cell, adenoma				X		X																					X	
C-cell, carcinoma			X											X														
General Body System																												
None																												
Genital System																												
Clitoral gland	+	+	+	M	+	+	+	+	+	+	+	+	+	+	+	+	+	+	+	+	+	+	+	+	+	+	+	
Adenoma							X						X											X				
Carcinoma																	X		X									
Ovary	+	+	+	+	+	+	+	+	+	+	+	+	+	+	+	+	+	+	+	+	+	+	+	+	+	+	+	
Uterus	+	+	+	+	+	+	+	+	+	+	+	+	+	+	+	+	+	+	+	+	+	+	+	+	+	+	+	
Polyp stromal								X															X		X	X	X	
Polyp stromal, multiple																		X										
Hematopoietic System																												
Bone marrow	+	+	+	+	+	+	+	+	+	+	+	+	+	+	+	A	+	+	+	+	+	+	+	+	+	+	+	
Lymph node				+																								
Lymph node, bronchial	+	+	+	+	M	+	+	+	+	M	+	+	M	+	+	+	+	+	+	+	+	+	+	+	+	+	+	
Lymph node, mandibular	+	+	+	+	+	+	+	+	+	+	+	+	+	+	+	A	+	+	+	+	+	+	+	+	+	+	+	
Lymph node, mesenteric	+	+	+	+	+	+	+	+	+	+	+	+	+	+	+	M	+	+	+	+	+	+	+	+	+	+	+	
Lymph node, mediastinal	M	+	+	M	+	+	+	+	+	+	+	M	+	+	+	M	+	+	+	+	+	+	+	+	+	M	+	
Spleen	+	+	+	+	+	+	+	+	+	+	+	+	+	+	+	A	+	+	+	+	+	+	+	+	+	+	+	
Thymus	+	+	+	+	+	+	+	+	+	+	+	+	+	+	M	+	+	+	+	+	+	+	+	+	M	+	+	M

**TABLE B2
Individual Animal Tumor Pathology of Female Rats in the 2-Year Inhalation Study of Isobutene: 2,000 ppm**

Number of Days on Study	3	5	5	5	5	6	6	6	6	6	6	6	6	7	7	7	7	7	7	7	7	7	7	7	7	7	7
	9	2	3	5	6	0	2	2	4	5	8	8	8	0	0	0	2	3	3	3	3	3	3	3	3	3	3
	9	2	4	2	0	7	0	6	4	1	0	4	6	1	5	6	0	3	3	3	3	3	3	4	4	4	
Carcass ID Number	5	5	5	5	5	5	5	5	5	5	5	5	5	5	5	5	5	5	5	5	5	5	5	5	5	5	5
	3	0	5	4	4	2	2	2	3	4	3	3	4	0	2	0	4	0	0	0	0	0	0	0	1	1	
	7	3	0	7	3	1	3	6	8	6	6	5	2	2	4	7	4	1	4	5	6	8	9	0	1		
Integumentary System																											
Mammary gland	+	+	+	+	+	+	+	+	+	+	+	+	+	+	+	+	+	+	+	+	+	+	+	+	+	+	+
Adenoma																											X
Carcinoma													X														
Fibroadenoma					X		X			X	X	X		X	X		X										X
Fibroadenoma, multiple																		X	X			X					
Skin	+	+	+	+	+	+	+	+	+	+	+	+	+	+	+	+	+	+	+	+	+	+	+	+	+	+	+
Keratoacanthoma										X																	
Squamous cell papilloma																									X		
Subcutaneous tissue, fibroma																											
Subcutaneous tissue, melanoma malignant					X																						
Musculoskeletal System																											
Bone	+	+	+	+	+	+	+	+	+	+	+	+	+	+	+	+	+	+	+	+	+	+	+	+	+	+	+
Nervous System																											
Brain	+	+	+	+	+	+	+	+	+	+	+	+	+	+	+	+	+	+	+	+	+	+	+	+	+	+	+
Respiratory System																											
Larynx	+	+	+	+	+	+	+	+	+	+	+	+	+	+	+	+	+	+	+	+	+	+	+	+	+	+	+
Lung	+	+	+	+	+	+	+	+	+	+	+	+	+	+	+	+	+	+	+	+	+	+	+	+	+	+	+
Carcinoma, metastatic, thyroid gland																											
Nose	+	+	+	+	+	+	+	+	+	+	+	+	+	+	+	+	+	+	+	+	+	+	+	+	+	+	+
Trachea	+	+	+	+	+	+	+	+	+	+	+	+	+	+	+	+	+	+	+	+	+	+	+	+	+	+	+
Special Senses System																											
Eye																											
Zymbal's gland																											+
Carcinoma														X													
Urinary System																											
Kidney	+	+	+	+	+	+	+	+	+	+	+	+	+	+	+	A	+	+	+	+	+	+	+	+	+	+	+
Urinary bladder	+	+	+	+	+	+	+	+	+	+	+	+	+	+	+	A	+	+	+	+	+	+	+	+	+	+	+
Transitional epithelium, papilloma																											
Systemic Lesions																											
Multiple organs	+	+	+	+	+	+	+	+	+	+	+	+	+	+	+	+	+	+	+	+	+	+	+	+	+	+	+
Leukemia mononuclear			X	X		X		X	X	X		X		X			X	X	X			X					X

TABLE B2
Individual Animal Tumor Pathology of Female Rats in the 2-Year Inhalation Study of Isobutene: 2,000 ppm

Number of Days on Study	7 7 7 7 7 7 7 7 7 7 7 7 7 7 7 7 7 7 7 7 7 7 7 7																				Total Tissues/ Tumors
Carcass ID Number	5 5 5 5 5 5 5 5 5 5 5 5 5 5 5 5 5 5 5 5 5 5 5 5 1 1 1 1 1 1 1 1 2 2 2 2 2 2 3 3 3 3 3 3 4 4 4 4 2 3 4 5 6 7 8 9 0 2 5 7 8 9 0 1 2 3 4 9 0 1 5 8 9																				
Integumentary System																					
Mammary gland	+ + + + + + + + + + + + + + + + + + + + + + + +																				50
Adenoma																					1
Carcinoma	X X X X X X X X X X X X X X X X X X X X X X X X																				4
Fibroadenoma	X X X X X X X X X X X X X X X X X X X X X X X X																				24
Fibroadenoma, multiple	X X X X X X X X X X X X X X X X X X X X X X X X																				6
Skin	+ + + + + + + + + + + + + + + + + + + + + + + +																				50
Keratoacanthoma																					1
Squamous cell papilloma																					1
Subcutaneous tissue, fibroma	X																				1
Subcutaneous tissue, melanoma malignant																					1
Musculoskeletal System																					
Bone	+ + + + + + + + + + + + + + + + + + + + + + + +																				50
Nervous System																					
Brain	+ + + + + + + + + + + + + + + + + + + + + + + +																				50
Respiratory System																					
Larynx	+ + + + + + + + + + + + + + + + + + + + + + + +																				50
Lung	+ + + + + + + + + + + + + + + + + + + + + + + +																				50
Carcinoma, metastatic, thyroid gland	X X X X X X X X X X X X X X X X X X X X X X X X																				2
Nose	+ + + + + + + + + + + + + + + + + + + + + + + +																				50
Trachea	+ + + + + + + + + + + + + + + + + + + + + + + +																				50
Special Senses System																					
Eye	+ + + + + + + + + + + + + + + + + + + + + + + +																				6
Zymbal's gland																					1
Carcinoma																					1
Urinary System																					
Kidney	+ + + + + + + + + + + + + + + + + + + + + + + +																				49
Urinary bladder	+ + + + + + + + + + + + + + + + + + + + + + + +																				49
Transitional epithelium, papilloma	X																				1
Systemic Lesions																					
Multiple organs	+ + + + + + + + + + + + + + + + + + + + + + + +																				50
Leukemia mononuclear	X X X X X X X X X X X X X X X X X X X X X X X X																				22

TABLE B2
Individual Animal Tumor Pathology of Female Rats in the 2-Year Inhalation Study of Isobutene: 8,000 ppm

Number of Days on Study	0	4	4	5	5	5	5	5	5	5	5	6	6	6	6	6	6	6	6	6	6	6	7	7			
	0	0	6	0	1	1	4	5	8	9	9	2	3	4	5	5	6	6	6	7	7	8	9	0	0		
	5	7	9	0	1	2	7	9	0	2	7	8	0	2	0	7	3	4	8	1	4	1	2	2	6		
Carcass ID Number	7	7	7	7	7	7	7	7	7	7	7	7	7	7	7	7	7	7	7	7	7	7	7	7	7		
	3	2	3	1	4	3	1	3	2	4	0	0	1	2	0	4	1	0	2	3	1	3	3	2	0		
	9	4	5	9	4	3	1	0	5	3	8	5	3	8	3	8	0	1	3	8	4	6	7	2	2		
Hematopoietic System																											
Bone marrow	+	+	+	+	A	+	+	+	+	+	+	+	+	+	+	+	+	+	+	+	+	+	+	+	+	+	
Lymph node																											
Deep cervical, carcinoma, metastatic, thyroid gland																											
Lymph node, bronchial	+	M	M	M	M	+	M	M	+	+	+	+	+	+	M	+	+	M	M	+	M	+	+	M	+	+	
Lymph node, mandibular	+	+	+	+	M	+	+	+	+	+	+	+	+	+	+	+	+	+	+	+	+	+	+	+	+	+	
Lymph node, mesenteric	+	+	+	+	A	+	+	+	+	+	+	+	+	+	+	+	+	+	+	+	+	+	+	+	+	+	
Lymph node, mediastinal	+	+	+	M	+	+	+	+	+	+	+	+	+	+	+	+	+	+	+	+	+	+	+	+	+	+	
Spleen	+	+	+	+	+	+	+	+	+	+	+	+	+	+	+	+	+	+	+	+	+	+	+	+	+	+	
Hemangiosarcoma																											
Thymus	+	M	+	+	A	M	M	+	+	+	+	+	+	+	+	+	+	+	+	+	+	+	+	M	+	+	
Integumentary System																											
Mammary gland	+	+	+	+	+	+	+	+	+	+	+	+	+	+	+	+	+	+	+	+	+	+	+	+	+	+	
Carcinoma												X		X													
Fibroadenoma					X	X	X		X				X	X						X	X	X					
Fibroadenoma, multiple																											
Skin	+	+	+	+	+	+	+	+	+	+	+	+	+	+	+	+	+	+	+	+	+	+	+	+	+	+	
Musculoskeletal System																											
Bone	+	+	+	+	+	+	+	+	+	+	+	+	+	+	+	+	+	+	+	+	+	+	+	+	+	+	
Skeletal muscle																											
Nervous System																											
Brain	+	+	+	+	+	+	+	+	+	+	+	+	+	+	+	+	+	+	+	+	+	+	+	+	+	+	
Respiratory System																											
Larynx	+	+	+	+	+	+	+	+	+	+	+	+	+	+	+	+	+	+	+	+	+	+	+	+	+	+	
Lung	+	+	+	+	+	+	+	+	+	+	+	+	+	+	+	+	+	+	+	+	+	+	+	+	+	+	
Carcinoma, metastatic, thyroid gland																											
Nose	+	+	+	+	A	+	+	+	+	+	+	+	+	+	+	+	+	+	+	+	+	+	+	+	+	+	
Trachea	+	+	+	+	+	+	+	+	+	+	+	+	+	+	+	+	+	+	+	+	+	+	+	+	+	+	
Special Senses System																											
Eye																											
Lacrimal gland					+										+										+		
Urinary System																											
Kidney	+	+	+	+	A	+	+	+	+	+	+	+	+	+	+	+	+	+	+	+	+	+	+	+	+	+	
Lipoma																											
Urinary bladder	+	+	+	+	A	+	+	+	+	+	+	+	+	+	+	+	+	+	+	+	+	+	+	+	+	+	
Systemic Lesions																											
Multiple organs	+	+	+	+	+	+	+	+	+	+	+	+	+	+	+	+	+	+	+	+	+	+	+	+	+	+	
Leukemia mononuclear		X	X	X	X	X	X	X						X	X	X				X	X				X		

TABLE B3
Statistical Analysis of Primary Neoplasms in Female Rats in the 2-Year Inhalation Study of Isobutene

	Chamber Control	500 ppm	2,000 ppm	8,000 ppm
Adrenal Medulla: Benign Pheochromocytoma				
Overall rate ^a	3/50 (6%)	3/50 (6%)	10/49 (20%)	4/49 (8%)
Adjusted rate ^b	7.5%	8.2%	22.7%	10.2%
Terminal rate ^c	3/23 (13%)	2/19 (11%)	7/33 (21%)	2/22 (9%)
First incidence (days)	733 (T)	722	626	650
Poly-3 test ^d	P= 0.589	P= 0.625	P= 0.050	P= 0.493
Adrenal Medulla: Benign or Complex Pheochromocytoma				
Overall rate	4/50 (8%)	3/50 (6%)	10/49 (20%)	4/49 (8%)
Adjusted rate	10.0%	8.2%	22.7%	10.2%
Terminal rate	4/23 (17%)	2/19 (11%)	7/33 (21%)	2/22 (9%)
First incidence (days)	733 (T)	722	626	650
Poly-3 test	P= 0.516N	P= 0.545N	P= 0.101	P= 0.638
Clitoral Gland: Adenoma				
Overall rate	3/50 (6%)	3/49 (6%)	6/47 (13%)	0/48 (0%)
Adjusted rate	7.5%	8.4%	14.2%	0.0%
Terminal rate	3/23 (13%)	3/18 (17%)	4/31 (13%)	0/22 (0%)
First incidence (days)	733 (T)	733 (T)	620	— ^e
Poly-3 test	P= 0.080N	P= 0.611	P= 0.269	P= 0.129N
Clitoral Gland: Carcinoma				
Overall rate	1/50 (2%)	0/49 (0%)	5/47 (11%)	1/48 (2%)
Adjusted rate	2.5%	0.0%	12.0%	2.7%
Terminal rate	0/23 (0%)	0/18 (0%)	4/31 (13%)	1/22 (5%)
First incidence (days)	664	—	720	733 (T)
Poly-3 test	P= 0.622N	P= 0.523N	P= 0.109	P= 0.746
Clitoral Gland: Adenoma or Carcinoma				
Overall rate	4/50 (8%)	3/49 (6%)	11/47 (23%)	1/48 (2%)
Adjusted rate	10.0%	8.4%	26.1%	2.7%
Terminal rate	3/23 (13%)	3/18 (17%)	8/31 (26%)	1/22 (5%)
First incidence (days)	664	733 (T)	620	733 (T)
Poly-3 test	P= 0.115N	P= 0.564N	P= 0.051	P= 0.199N
Mammary Gland: Fibroadenoma				
Overall rate	22/50 (44%)	19/50 (38%)	30/50 (60%)	27/50 (54%)
Adjusted rate	52.9%	46.6%	65.6%	62.9%
Terminal rate	14/23 (61%)	8/19 (42%)	23/33 (70%)	16/22 (73%)
First incidence (days)	581	440	560	511
Poly-3 test	P= 0.144	P= 0.357N	P= 0.152	P= 0.230
Mammary Gland: Fibroadenoma or Adenoma				
Overall rate	22/50 (44%)	20/50 (40%)	31/50 (62%)	27/50 (54%)
Adjusted rate	52.9%	49.1%	67.8%	62.9%
Terminal rate	14/23 (61%)	9/19 (47%)	24/33 (73%)	16/22 (73%)
First incidence (days)	581	440	560	511
Poly-3 test	P= 0.178	P= 0.446N	P= 0.104	P= 0.230
Mammary Gland: Carcinoma				
Overall rate	2/50 (4%)	2/50 (4%)	4/50 (8%)	4/50 (8%)
Adjusted rate	4.9%	5.5%	9.1%	10.0%
Terminal rate	1/23 (4%)	2/19 (11%)	3/33 (9%)	2/22 (9%)
First incidence (days)	488	733 (T)	701	597
Poly-3 test	P= 0.284	P= 0.658	P= 0.377	P= 0.331

TABLE B3
Statistical Analysis of Primary Neoplasms in Female Rats in the 2-Year Inhalation Study of Isobutene

	Chamber Control	500 ppm	2,000 ppm	8,000 ppm
Mammary Gland: Adenoma or Carcinoma				
Overall rate	3/50 (6%)	3/50 (6%)	5/50 (10%)	4/50 (8%)
Adjusted rate	7.4%	8.2%	11.3%	10.0%
Terminal rate	2/23 (9%)	3/19 (16%)	4/33 (12%)	2/22 (9%)
First incidence (days)	488	733 (T)	701	597
Poly-3 test	P= 0.478	P= 0.616	P= 0.403	P= 0.494
Mammary Gland: Fibroadenoma, Adenoma, or Carcinoma				
Overall rate	23/50 (46%)	21/50 (42%)	32/50 (64%)	30/50 (60%)
Adjusted rate	54.4%	51.5%	69.8%	68.5%
Terminal rate	14/23 (61%)	10/19 (53%)	24/33 (73%)	17/22 (77%)
First incidence (days)	488	440	560	511
Poly-3 test	P= 0.081	P= 0.481N	P= 0.092	P= 0.117
Pituitary Gland (Pars Distalis): Adenoma				
Overall rate	39/50 (78%)	33/49 (67%)	37/50 (74%)	36/49 (73%)
Adjusted rate	87.8%	77.1%	76.5%	83.7%
Terminal rate	21/23 (91%)	13/18 (72%)	25/33 (76%)	21/22 (95%)
First incidence (days)	496	455	399	469
Poly-3 test	P= 0.492	P= 0.126N	P= 0.111N	P= 0.391N
Skin (Subcutaneous Tissue): Fibrous Histiocytoma, Fibrosarcoma, or Sarcoma				
Overall rate	2/50 (4%)	3/50 (6%)	0/50 (0%)	0/50 (0%)
Adjusted rate	4.9%	8.0%	0.0%	0.0%
Terminal rate	1/23 (4%)	1/19 (5%)	0/33 (0%)	0/22 (0%)
First incidence (days)	488	548	—	—
Poly-3 test	P= 0.117N	P= 0.462	P= 0.219N	P= 0.244N
Skin (Subcutaneous Tissue): Fibroma, Fibrous Histiocytoma, Fibrosarcoma, or Sarcoma				
Overall rate	3/50 (6%)	3/50 (6%)	1/50 (2%)	0/50 (0%)
Adjusted rate	7.4%	8.0%	2.3%	0.0%
Terminal rate	2/23 (9%)	1/19 (5%)	1/33 (3%)	0/22 (0%)
First incidence (days)	488	548	733 (T)	—
Poly-3 test	P= 0.079N	P= 0.625	P= 0.276N	P= 0.123N
Thyroid Gland (C-cell): Adenoma				
Overall rate	7/50 (14%)	6/50 (12%)	3/49 (6%)	5/49 (10%)
Adjusted rate	17.6%	16.4%	6.8%	12.7%
Terminal rate	7/23 (30%)	6/19 (32%)	1/33 (3%)	3/22 (14%)
First incidence (days)	733 (T)	733 (T)	552	663
Poly-3 test	P= 0.416N	P= 0.565N	P= 0.117N	P= 0.384N
Thyroid Gland (C-cell): Carcinoma				
Overall rate	2/50 (4%)	3/50 (6%)	6/49 (12%)	2/49 (4%)
Adjusted rate	5.0%	8.0%	13.7%	5.1%
Terminal rate	0/23 (0%)	0/19 (0%)	4/33 (12%)	1/22 (5%)
First incidence (days)	720	603	534	729
Poly-3 test	P= 0.444N	P= 0.473	P= 0.164	P= 0.686
Thyroid Gland (C-cell): Adenoma or Carcinoma				
Overall rate	9/50 (18%)	9/50 (18%)	9/49 (18%)	7/49 (14%)
Adjusted rate	22.5%	23.9%	20.1%	17.7%
Terminal rate	7/23 (30%)	6/19 (32%)	5/33 (15%)	4/22 (18%)
First incidence (days)	720	603	534	663
Poly-3 test	P= 0.326N	P= 0.550	P= 0.495N	P= 0.400N

TABLE B3
Statistical Analysis of Primary Neoplasms in Female Rats in the 2-Year Inhalation Study of Isobutene

	Chamber Control	500 ppm	2,000 ppm	8,000 ppm
Uterus: Stromal Polyp				
Overall rate	8/50 (16%)	9/50 (18%)	8/50 (16%)	5/50 (10%)
Adjusted rate	18.9%	23.0%	18.0%	12.1%
Terminal rate	1/23 (4%)	4/19 (21%)	7/33 (21%)	2/22 (9%)
First incidence (days)	529	420	626	407
Poly-3 test	P= 0.169N	P= 0.429	P= 0.567N	P= 0.287N
All Organs: Mononuclear Cell Leukemia				
Overall rate	18/50 (36%)	16/50 (32%)	22/50 (44%)	17/50 (34%)
Adjusted rate	41.6%	39.9%	46.8%	37.3%
Terminal rate	7/23 (30%)	7/19 (37%)	13/33 (39%)	3/22 (14%)
First incidence (days)	421	420	534	407
Poly-3 test	P= 0.349N	P= 0.525N	P= 0.386	P= 0.421N
All Organs: Benign Neoplasms				
Overall rate	42/50 (84%)	45/50 (90%)	48/50 (96%)	46/50 (92%)
Adjusted rate	92.7%	94.8%	96.1%	95.7%
Terminal rate	22/23 (96%)	17/19 (90%)	32/33 (97%)	21/22 (96%)
First incidence (days)	496	420	399	407
Poly-3 test	P= 0.444	P= 0.507	P= 0.375	P= 0.417
All Organs: Malignant Neoplasms				
Overall rate	30/50 (60%)	24/50 (48%)	30/50 (60%)	25/50 (50%)
Adjusted rate	63.6%	56.1%	63.6%	54.3%
Terminal rate	12/23 (52%)	9/19 (47%)	20/33 (61%)	9/22 (41%)
First incidence (days)	390	216	534	407
Poly-3 test	P= 0.257N	P= 0.303N	P= 0.585	P= 0.237N
All Organs: Benign or Malignant Neoplasms				
Overall rate	50/50 (100%)	48/50 (96%)	49/50 (98%)	48/50 (96%)
Adjusted rate	100.0%	98.0%	98.0%	98.0%
Terminal rate	23/23 (100%)	18/19 (95%)	32/33 (97%)	21/22 (96%)
First incidence (days)	390	216	399	407
Poly-3 test	P= 0.521N	P= 0.496N	P= 0.500N	P= 0.496N

(T) Terminal sacrifice

^a Number of neoplasm-bearing animals/number of animals examined. Denominator is number of animals examined microscopically for adrenal gland, clitoral gland, pituitary gland, thyroid gland, and uterus; for other tissues, denominator is number of animals necropsied.

^b Poly-3 estimated neoplasm incidence after adjustment for intercurrent mortality

^c Observed incidence at terminal kill

^d Beneath the chamber control incidence are the P values associated with the trend test. Beneath the exposed group incidence are the P values corresponding to pairwise comparisons between the chamber controls and that exposed group. The Poly-3 test accounts for differential mortality in animals that do not reach terminal sacrifice. A negative trend or a lower incidence in an exposure group is indicated by N.

^e Not applicable; no neoplasms in animal group

TABLE B4
Summary of the Incidence of Nonneoplastic Lesions in Female Rats in the 2-Year Inhalation Study of Isobutene^a

	Chamber Control	500 ppm	2,000 ppm	8,000 ppm
Disposition Summary				
Animals initially in study	50	50	50	50
Early deaths				
Accidental death		1		
Moribund	21	25	15	23
Natural deaths	6	5	2	5
Survivors				
Terminal sacrifice	23	19	33	22
Animals examined microscopically	50	50	50	50
Alimentary System				
Esophagus	(50)	(50)	(50)	(50)
Inflammation, suppurative			1 (2%)	
Intestine large, colon	(49)	(50)	(49)	(49)
Inflammation, acute		1 (2%)		
Parasite metazoan	5 (10%)		1 (2%)	1 (2%)
Intestine large, rectum	(47)	(47)	(47)	(48)
Parasite metazoan	8 (17%)	5 (11%)	5 (11%)	3 (6%)
Intestine large, cecum	(48)	(49)	(48)	(49)
Inflammation, acute	1 (2%)	1 (2%)		
Parasite metazoan	5 (10%)	2 (4%)	4 (8%)	3 (6%)
Intestine small, jejunum	(47)	(47)	(48)	(47)
Inflammation, acute		1 (2%)		
Necrosis			1 (2%)	
Intestine small, ileum	(46)	(47)	(48)	(47)
Inflammation, acute		1 (2%)		
Parasite metazoan				1 (2%)
Liver	(50)	(50)	(50)	(49)
Angiectasis	1 (2%)	3 (6%)	4 (8%)	3 (6%)
Basophilic focus	36 (72%)	36 (72%)	43 (86%)	36 (73%)
Clear cell focus	6 (12%)	9 (18%)	12 (24%)	5 (10%)
Cytomegaly				1 (2%)
Degeneration, cystic			2 (4%)	
Degeneration, fatty	12 (24%)	10 (20%)	12 (24%)	12 (24%)
Eosinophilic focus	6 (12%)	6 (12%)	5 (10%)	9 (18%)
Hematopoietic cell proliferation			1 (2%)	
Hepatodiaphragmatic nodule	4 (8%)	7 (14%)	5 (10%)	3 (6%)
Inflammation, granulomatous	1 (2%)			
Mitotic alteration		1 (2%)		
Mixed cell focus	7 (14%)	11 (22%)	9 (18%)	8 (16%)
Necrosis	2 (4%)		2 (4%)	
Regeneration	1 (2%)	1 (2%)	2 (4%)	3 (6%)
Thrombosis	1 (2%)			
Bile duct, hyperplasia	9 (18%)	5 (10%)	7 (14%)	10 (20%)
Centrilobular, necrosis	4 (8%)	4 (8%)	5 (10%)	9 (18%)
Mesentery	(8)	(10)	(12)	(7)
Thrombosis			1 (8%)	
Artery, inflammation, chronic active				2 (29%)
Fat, hemorrhage	1 (13%)			
Fat, necrosis	8 (100%)	10 (100%)	12 (100%)	6 (86%)

^a Number of animals examined microscopically at the site and the number of animals with lesion

TABLE B4
Summary of the Incidence of Nonneoplastic Lesions in Female Rats in the 2-Year Inhalation Study of Isobutene

	Chamber Control	500 ppm	2,000 ppm	8,000 ppm
Alimentary System (continued)				
Pancreas	(50)	(50)	(49)	(49)
Atrophy	9 (18%)	11 (22%)	17 (35%)	10 (20%)
Basophilic focus	1 (2%)	4 (8%)	3 (6%)	2 (4%)
Hyperplasia		1 (2%)	1 (2%)	
Metaplasia, hepatocyte	1 (2%)			
Salivary glands	(50)	(50)	(50)	(50)
Atrophy		1 (2%)		1 (2%)
Stomach, forestomach	(50)	(50)	(50)	(50)
Hyperplasia, basal cell		1 (2%)		
Inflammation, acute	1 (2%)			
Mineralization	1 (2%)			
Necrosis	7 (14%)	7 (14%)	6 (12%)	5 (10%)
Stomach, glandular	(50)	(50)	(50)	(49)
Mineralization			1 (2%)	
Necrosis	3 (6%)	2 (4%)	1 (2%)	1 (2%)
Tongue		(1)		(1)
Hyperplasia, squamous				1 (100%)
Tooth			(1)	
Necrosis			1 (100%)	
Cardiovascular System				
Heart	(50)	(50)	(49)	(50)
Cardiomyopathy	30 (60%)	29 (58%)	37 (76%)	31 (62%)
Atrium, thrombosis			1 (2%)	
Endocrine System				
Adrenal cortex	(50)	(50)	(49)	(49)
Atrophy		1 (2%)		1 (2%)
Degeneration, cystic	2 (4%)	2 (4%)	4 (8%)	2 (4%)
Hyperplasia	15 (30%)	16 (32%)	24 (49%)	21 (43%)
Hypertrophy	11 (22%)	8 (16%)	9 (18%)	9 (18%)
Necrosis	2 (4%)		3 (6%)	1 (2%)
Thrombosis		1 (2%)		
Vacuolization cytoplasmic				1 (2%)
Adrenal medulla	(50)	(50)	(49)	(49)
Hyperplasia	10 (20%)	5 (10%)	6 (12%)	10 (20%)
Islets, pancreatic	(50)	(50)	(49)	(49)
Hyperplasia		1 (2%)		
Pituitary gland	(50)	(49)	(50)	(49)
Angiectasis			1 (2%)	
Pars distalis, angiectasis		1 (2%)		1 (2%)
Pars distalis, cyst				1 (2%)
Pars distalis, hyperplasia	7 (14%)	7 (14%)	11 (22%)	5 (10%)
Thyroid gland	(50)	(50)	(49)	(49)
C-cell, hyperplasia	37 (74%)	34 (68%)	38 (78%)	35 (71%)
Follicular cell, hyperplasia		2 (4%)		
General Body System				
None				

TABLE B4
Summary of the Incidence of Nonneoplastic Lesions in Female Rats in the 2-Year Inhalation Study of Isobutene

	Chamber Control	500 ppm	2,000 ppm	8,000 ppm
Genital System				
Clitoral gland	(50)	(49)	(47)	(48)
Hyperplasia	1 (2%)		5 (11%)	1 (2%)
Inflammation, chronic active			1 (2%)	
Ovary	(50)	(50)	(50)	(50)
Cyst	9 (18%)	4 (8%)	4 (8%)	2 (4%)
Inflammation, granulomatous			1 (2%)	
Uterus	(50)	(50)	(50)	(50)
Fibrosis			1 (2%)	
Inflammation, chronic active				1 (2%)
Necrosis				1 (2%)
Cervix, hypertrophy		1 (2%)		
Vagina	(1)	(1)		(1)
Inflammation, suppurative				1 (100%)
Hematopoietic System				
Bone marrow	(50)	(50)	(49)	(49)
Atrophy	1 (2%)	1 (2%)		2 (4%)
Hyperplasia, histiocytic				1 (2%)
Hyperplasia, reticulum cell			1 (2%)	
Lymph node	(6)	(3)	(3)	(2)
Pancreatic, ectasia		1 (33%)		
Lymph node, mandibular	(44)	(46)	(47)	(47)
Infiltration cellular, plasma cell		1 (2%)		
Infiltration cellular, polymorphonuclear				1 (2%)
Lymph node, mesenteric	(50)	(50)	(49)	(49)
Infiltration cellular, plasma cell			1 (2%)	
Spleen	(50)	(50)	(49)	(50)
Accessory spleen		1 (2%)		
Fibrosis		3 (6%)	6 (12%)	2 (4%)
Hematopoietic cell proliferation	5 (10%)	2 (4%)	3 (6%)	2 (4%)
Hemorrhage	1 (2%)			2 (4%)
Inflammation, granulomatous				1 (2%)
Necrosis	1 (2%)			
Integumentary System				
Mammary gland	(50)	(50)	(50)	(50)
Galactocele	2 (4%)	2 (4%)	1 (2%)	2 (4%)
Hyperplasia, atypical				1 (2%)
Inflammation, acute			1 (2%)	
Inflammation, chronic	1 (2%)			
Skin	(50)	(50)	(50)	(50)
Cyst epithelial inclusion		1 (2%)		
Hyperkeratosis	1 (2%)			
Inflammation, acute			1 (2%)	
Inflammation, chronic active	1 (2%)		1 (2%)	2 (4%)

TABLE B4
Summary of the Incidence of Nonneoplastic Lesions in Female Rats in the 2-Year Inhalation Study of Isobutene

	Chamber Control	500 ppm	2,000 ppm	8,000 ppm
Musculoskeletal System				
Bone	(50)	(50)	(50)	(50)
Hyperostosis	9 (18%)	7 (14%)	11 (22%)	15 (30%)
Skeletal muscle				(1)
Artery, inflammation, chronic				1 (100%)
Nervous System				
Brain	(50)	(50)	(50)	(50)
Hemorrhage	1 (2%)			
Artery, inflammation, chronic				1 (2%)
Respiratory System				
Larynx	(50)	(50)	(50)	(50)
Epiglottis, metaplasia, squamous				2 (4%)
Lung	(50)	(50)	(50)	(50)
Inflammation, granulomatous	7 (14%)	5 (10%)	9 (18%)	11 (22%)
Inflammation, suppurative		1 (2%)		
Alveolar epithelium, hyperplasia	9 (18%)	9 (18%)	7 (14%)	6 (12%)
Alveolus, infiltration cellular, histiocyte		1 (2%)		
Bronchiole, hyperplasia			1 (2%)	
Nose	(50)	(50)	(50)	(49)
Inflammation, suppurative	7 (14%)	2 (4%)	8 (16%)	8 (16%)
Thrombosis	2 (4%)	3 (6%)	2 (4%)	3 (6%)
Lateral wall, metaplasia, squamous				3 (6%)
Olfactory epithelium, degeneration, hyaline	44 (88%)	47 (94%)	48 (96%)	47 (96%)
Respiratory epithelium, metaplasia, squamous		1 (2%)		
Special Senses System				
Eye	(4)	(4)	(6)	(4)
Cataract	4 (100%)	3 (75%)	6 (100%)	4 (100%)
Retina, atrophy	3 (75%)	3 (75%)	6 (100%)	4 (100%)
Urinary System				
Kidney	(50)	(50)	(49)	(49)
Infarct	1 (2%)			2 (4%)
Nephropathy	46 (92%)	46 (92%)	46 (94%)	46 (94%)
Renal tubule, hyperplasia		1 (2%)		
Urinary bladder	(50)	(49)	(49)	(49)
Hemorrhage				1 (2%)

APPENDIX C
SUMMARY OF LESIONS IN MALE MICE
IN THE 2-YEAR INHALATION STUDY
OF ISOBUTENE

TABLE C1	Summary of the Incidence of Neoplasms in Male Mice in the 2-Year Inhalation Study of Isobutene	127
TABLE C2	Individual Animal Tumor Pathology of Male Mice in the 2-Year Inhalation Study of Isobutene	130
TABLE C3	Statistical Analysis of Primary Neoplasms in Male Mice in the 2-Year Inhalation Study of Isobutene	146
TABLE C4	Summary of the Incidence of Nonneoplastic Lesions in Male Mice in the 2-Year Inhalation Study of Isobutene	149

TABLE C1
Summary of the Incidence of Neoplasms in Male Mice in the 2-Year Inhalation Study of Isobutene^a

	Chamber Control	500 ppm	2,000 ppm	8,000 ppm
Disposition Summary				
Animals initially in study	50	50	50	50
Early deaths				
Moribund	16	9	20	13
Natural deaths	6	9	3	9
Survivors				
Terminal sacrifice	28	32	27	28
Animals examined microscopically	50	50	50	50
Alimentary System				
Gallbladder	(46)	(40)	(45)	(34)
Intestine large, cecum	(47)	(45)	(49)	(42)
Leiomyoma				1 (2%)
Intestine small, duodenum	(46)	(45)	(48)	(42)
Histiocytic sarcoma	1 (2%)			
Intestine small, jejunum	(45)	(43)	(48)	(43)
Carcinoma		1 (2%)		1 (2%)
Intestine small, ileum	(46)	(43)	(48)	(42)
Liver	(50)	(50)	(50)	(49)
Hemangiosarcoma	1 (2%)		2 (4%)	2 (4%)
Hepatoblastoma			1 (2%)	
Hepatocellular carcinoma	12 (24%)	12 (24%)	10 (20%)	7 (14%)
Hepatocellular carcinoma, multiple	1 (2%)	1 (2%)	4 (8%)	7 (14%)
Hepatocellular adenoma	15 (30%)	20 (40%)	13 (26%)	10 (20%)
Hepatocellular adenoma, multiple	5 (10%)	4 (8%)	5 (10%)	7 (14%)
Histiocytic sarcoma			1 (2%)	
Pancreas	(50)	(48)	(50)	(47)
Salivary glands	(50)	(49)	(50)	(50)
Stomach, forestomach	(50)	(49)	(50)	(48)
Squamous cell papilloma	1 (2%)			
Tooth	(7)	(14)	(9)	(16)
Odontoma	1 (14%)	3 (21%)	2 (22%)	2 (13%)
Cardiovascular System				
Heart	(50)	(50)	(50)	(50)
Hemangiosarcoma				1 (2%)
Pheochromocytoma malignant, metastatic, adrenal medulla		1 (2%)		
Endocrine System				
Adrenal cortex	(49)	(49)	(50)	(49)
Adenoma	1 (2%)	1 (2%)	1 (2%)	
Capsule, adenoma	1 (2%)	2 (4%)		3 (6%)
Adrenal medulla	(49)	(49)	(50)	(49)
Pheochromocytoma malignant		1 (2%)		
Pheochromocytoma benign		1 (2%)	1 (2%)	2 (4%)
Islets, pancreatic	(50)	(48)	(50)	(48)
Adenoma		1 (2%)		
Pituitary gland	(50)	(48)	(49)	(48)
Pars intermedia, adenoma				1 (2%)
Thyroid gland	(50)	(50)	(50)	(49)
Follicular cell, adenoma			1 (2%)	

TABLE C1
Summary of the Incidence of Neoplasms in Male Mice in the 2-Year Inhalation Study of Isobutene

	Chamber Control	500 ppm	2,000 ppm	8,000 ppm
General Body System				
None				
Genital System				
Epididymis	(50)	(50)	(50)	(50)
Prostate	(48)	(46)	(47)	(48)
Seminal vesicle	(49)	(47)	(50)	(47)
Testes	(50)	(50)	(50)	(50)
Interstitial cell, adenoma			1 (2%)	1 (2%)
Hematopoietic System				
Bone marrow	(50)	(49)	(50)	(49)
Histiocytic sarcoma			1 (2%)	
Lymph node	(4)	(3)	(7)	(1)
Renal, histiocytic sarcoma	1 (25%)			
Lymph node, bronchial	(30)	(33)	(32)	(32)
Pheochromocytoma malignant, metastatic, adrenal medulla		1 (3%)		
Lymph node, mandibular	(34)	(29)	(33)	(35)
Lymph node, mesenteric	(48)	(49)	(48)	(49)
Histiocytic sarcoma	1 (2%)		1 (2%)	
Lymph node, mediastinal	(37)	(38)	(36)	(31)
Histiocytic sarcoma			1 (3%)	
Pheochromocytoma malignant, metastatic, adrenal medulla		1 (3%)		
Spleen	(50)	(49)	(50)	(48)
Hemangiosarcoma		1 (2%)		1 (2%)
Histiocytic sarcoma	1 (2%)		1 (2%)	1 (2%)
Thymus	(41)	(42)	(38)	(41)
Integumentary System				
Skin	(49)	(50)	(50)	(50)
Subcutaneous tissue, hemangioma			1 (2%)	
Subcutaneous tissue, sarcoma			1 (2%)	1 (2%)
Musculoskeletal System				
None				
Nervous System				
None				
Respiratory System				
Lung	(50)	(50)	(50)	(50)
Alveolar/bronchiolar adenoma	9 (18%)	5 (10%)	5 (10%)	3 (6%)
Alveolar/bronchiolar adenoma, multiple	3 (6%)	2 (4%)		
Alveolar/bronchiolar carcinoma	6 (12%)	5 (10%)	4 (8%)	3 (6%)
Alveolar/bronchiolar carcinoma, multiple		1 (2%)		3 (6%)
Hepatocellular carcinoma, metastatic, liver	4 (8%)	4 (8%)	2 (4%)	3 (6%)
Histiocytic sarcoma			1 (2%)	
Pheochromocytoma malignant, metastatic, adrenal medulla		1 (2%)		

TABLE C1
Summary of the Incidence of Neoplasms in Male Mice in the 2-Year Inhalation Study of Isobutene

	Chamber Control	500 ppm	2,000 ppm	8,000 ppm
Special Senses System				
Harderian gland	(4)	(4)	(4)	(4)
Adenoma	2 (50%)	3 (75%)	4 (100%)	2 (50%)
Carcinoma	1 (25%)			2 (50%)
Bilateral, adenoma	1 (25%)			
Urinary System				
Kidney	(50)	(49)	(50)	(50)
Hepatocellular carcinoma, metastatic, liver		1 (2%)		
Histiocytic sarcoma			1 (2%)	
Pheochromocytoma malignant, metastatic, adrenal medulla		1 (2%)		
Renal tubule, adenoma	1 (2%)		2 (4%)	
Systemic Lesions				
Multiple organs ^b	(50)	(50)	(50)	(50)
Histiocytic sarcoma	1 (2%)		1 (2%)	1 (2%)
Lymphoma malignant	4 (8%)	2 (4%)	5 (10%)	5 (10%)
Neoplasm Summary				
Total animals with primary neoplasms ^c	41	41	36	38
Total primary neoplasms	66	66	64	66
Total animals with benign neoplasms	30	32	27	23
Total benign neoplasms	40	42	36	32
Total animals with malignant neoplasms	21	19	23	23
Total malignant neoplasms	26	24	28	34
Total animals with metastatic neoplasms	4	5	2	3
Total metastatic neoplasms	4	10	2	3

^a Number of animals examined microscopically at the site and the number of animals with neoplasm

^b Number of animals with any tissue examined microscopically

^c Primary neoplasms: all neoplasms except metastatic neoplasms

TABLE C2
Individual Animal Tumor Pathology of Male Mice in the 2-Year Inhalation Study of Isobutene: Chamber Control

Number of Days on Study	3	3	4	4	5	5	5	5	5	6	6	6	6	6	6	6	6	6	6	7	7	7	7	7	7	7	
	8	9	2	8	2	6	8	8	9	0	1	1	5	5	6	8	9	9	0	0	1	2	3	3	3	3	
	7	9	6	3	7	0	0	9	2	8	0	1	3	3	4	1	5	5	8	9	5	3	3	3	3	3	
Carcass ID Number	0	0	0	0	0	0	0	0	0	0	0	0	0	0	0	0	0	0	0	0	0	0	0	0	0	0	
	4	5	1	0	2	0	3	4	4	3	0	3	2	3	1	1	1	4	3	2	1	3	0	0	0	0	
	0	0	4	3	6	2	2	7	4	4	9	1	8	3	5	2	7	8	8	3	6	5	1	4	5	5	
Alimentary System																											
Esophagus	+	+	+	+	+	+	+	+	+	+	+	+	+	+	+	+	+	+	+	+	+	+	+	+	+	+	+
Gallbladder	+	+	A	+	+	+	+	M	+	+	+	+	+	+	+	+	+	+	+	A	M	+	+	+	+	+	+
Intestine large, colon	+	+	+	+	+	A	+	A	+	+	+	+	+	+	+	+	+	+	+	A	+	+	+	+	+	+	+
Intestine large, rectum	+	+	+	+	+	A	+	A	+	+	+	+	+	+	+	+	+	+	+	A	+	+	+	+	+	+	+
Intestine large, cecum	+	+	+	+	+	A	+	A	+	+	+	+	+	+	+	+	+	+	+	A	+	+	+	+	+	+	+
Intestine small, duodenum	+	+	A	+	+	A	+	A	+	+	+	+	+	+	+	+	+	+	+	A	+	+	+	+	+	+	+
Histiocytic sarcoma																											
Intestine small, jejunum	+	+	A	+	+	A	+	A	A	+	+	+	+	+	+	+	+	+	+	A	+	+	+	+	+	+	+
Intestine small, ileum	+	+	A	+	+	A	+	A	+	+	+	+	+	+	+	+	+	+	+	A	+	+	+	+	+	+	+
Liver	+	+	+	+	+	+	+	+	+	+	+	+	+	+	+	+	+	+	+	+	+	+	+	+	+	+	+
Hemangiosarcoma																											
Hepatocellular carcinoma			X		X		X	X	X				X			X	X			X		X					
Hepatocellular carcinoma, multiple										X																	
Hepatocellular adenoma																X	X	X		X							X
Hepatocellular adenoma, multiple									X					X													
Mesentery																											
Pancreas	+	+	+	+	+	+	+	+	+	+	+	+	+	+	+	+	+	+	+	+	+	+	+	+	+	+	+
Salivary glands	+	+	+	+	+	+	+	+	+	+	+	+	+	+	+	+	+	+	+	+	+	+	+	+	+	+	+
Stomach, forestomach	+	+	+	+	+	+	+	+	+	+	+	+	+	+	+	+	+	+	+	+	+	+	+	+	+	+	+
Squamous cell papilloma																											
Stomach, glandular	+	+	+	+	+	+	+	A	+	+	+	+	+	+	+	+	+	+	+	+	+	+	+	+	+	+	+
Tooth						+			+																		
Odontoma						X																					
Cardiovascular System																											
Heart	+	+	+	+	+	+	+	+	+	+	+	+	+	+	+	+	+	+	+	+	+	+	+	+	+	+	+
Endocrine System																											
Adrenal cortex	+	+	+	+	+	+	+	+	A	+	+	+	+	+	+	+	+	+	+	+	+	+	+	+	+	+	+
Adenoma																											
Capsule, adenoma																											
Adrenal medulla	+	+	+	+	+	+	+	+	A	+	+	+	+	+	+	+	+	+	+	+	+	+	+	+	+	+	+
Islets, pancreatic	+	+	+	+	+	+	+	+	+	+	+	+	+	+	+	+	+	+	+	+	+	+	+	+	+	+	+
Parathyroid gland	+	+	+	+	+	+	+	M	M	M	M	M	+	M	+	+	+	+	M	+	+	+	+	+	+	+	+
Pituitary gland	+	+	+	+	+	+	+	+	+	+	+	+	+	+	+	+	+	+	+	+	+	+	+	+	+	+	+
Thyroid gland	+	+	+	+	+	+	+	+	+	+	+	+	+	+	+	+	+	+	+	+	+	+	+	+	+	+	+
General Body System																											
None																											
Genital System																											
Epididymis	+	+	+	+	+	+	+	+	+	+	+	+	+	+	+	+	+	+	+	+	+	+	+	+	+	+	+
Preputial gland	+	+	+	+	+	+	+	+	+	+	+	+	+	+	+	+	+	+	+	+	+	+	+	+	+	+	+
Prostate	+	+	+	+	+	+	+	A	+	+	+	+	+	+	+	+	+	+	+	+	+	+	+	+	+	+	+
Seminal vesicle	+	+	+	+	+	+	+	A	+	+	+	+	+	+	+	+	+	+	+	+	+	+	+	+	+	+	+
Testes	+	+	+	+	+	+	+	+	+	+	+	+	+	+	+	+	+	+	+	+	+	+	+	+	+	+	+

+ : Tissue examined microscopically
A: Autolysis precludes examination

M: Missing tissue
I: Insufficient tissue

X: Lesion present
Blank: Not examined

TABLE C2
Individual Animal Tumor Pathology of Male Mice in the 2-Year Inhalation Study of Isobutene: Chamber Control

Number of Days on Study	7 7 7 7 7 7 7 7 7 7 7 7 7 7 7 7 7 7 7 7 7 7 7
Carcass ID Number	3 3 3 3 3 3 3 3 3 3 3 3 3 3 3 3 3 3 3 3 3 3 3 3 3 3 3 3 3 3 3 3 3 3 3 3 4 4 4 4 4 4 4 4 4 4 4
	0 0 0 0 0 0 0 0 0 0 0 0 0 0 0 0 0 0 0 0 0 0 0 Total 0 0 0 1 1 1 1 2 2 2 2 2 2 2 3 3 3 3 4 4 4 4 4 Tissues/ 6 7 8 0 1 3 8 9 0 1 2 4 5 7 9 0 6 7 9 1 2 3 5 6 9 Tumors
Hematopoietic System	
Bone marrow	+ + + + + + + + + + + + + + + + + + + + + + + 50
Lymph node	+ + + + + + + + + + + + + + + + + + + + + + + 4
Renal, histiocytic sarcoma	+ + + + + + + + + + + + + + + + + + + + + + + 1
Lymph node, bronchial	M M + M M + + + + M M + + + M + + + + + + M + + M 30
Lymph node, mandibular	+ + M + + + M + + + + + + + + + + M M + M M M + + + 34
Lymph node, mesenteric	+ + + + + + + + + + + + + + + + + + + + + + + 48
Histiocytic sarcoma	+ + + + + + + + + + + + + + + + + + + + + + + 1
Lymph node, mediastinal	+ + M M + M + M + M M + + + + M + + + + + + + + + 37
Spleen	+ + + + + + + + + + + + + + + + + + + + + + + 50
Histiocytic sarcoma	+ + + + + + + + + + + + + + + + + + + + + + + 1
Thymus	+ + M + + + + + + + + M M + + + + + M + + + + + + 41
Integumentary System	
Mammary gland	M M M M M M M M M M M M M M M M M M M M M M M 49
Skin	+ + + + + I + + + + + + + + + + + + + + + + + + + 49
Musculoskeletal System	
Bone	+ + + + + + + + + + + + + + + + + + + + + + + 50
Nervous System	
Brain	+ + + + + + + + + + + + + + + + + + + + + + + 50
Respiratory System	
Larynx	+ + + + + + + + + + + + + + + + + + + + + + + 50
Lung	+ + + + + + + + + + + + + + + + + + + + + + + 50
Alveolar/bronchiolar adenoma	+ + + + + X X + + + + + + + + + X X X 9
Alveolar/bronchiolar adenoma, multiple	+ + + + + + + + + + + + + + + + + + + + + + X 3
Alveolar/bronchiolar carcinoma	+ + + + + + + + + + + + + + + + + + + + + + X X X 6
Hepatocellular carcinoma, metastatic, liver	+ + + + + + + + + + + + + + + + + + + + + + X 4
Nose	+ + + + + + + + + + + + + + + + + + + + + + + 50
Trachea	+ + + + + + + + + + + + + + + + + + + + + + + 50
Special Senses System	
Eye	+ + + + + + + + + + + + + + + + + + + + + + + 2
Harderian gland	+ + + + + + + + + + + + + + + + + + + + + + + 4
Adenoma	+ + + + + + + + + + + + + + + + + + + + + + + 2
Carcinoma	+ + + + + + + + + + + + + + + + + + + + + + + X 1
Bilateral, adenoma	+ + + + + + + + + + + + + + + + + + + + + + + X 1
Urinary System	
Kidney	+ + + + + + + + + + + + + + + + + + + + + + + 50
Renal tubule, adenoma	+ + + + + + + + + + + + + + + + + + + + + + + X 1
Urinary bladder	+ + + + + + + + + + + + + + + + + + + + + + + 49
Systemic Lesions	
Multiple organs	+ + + + + + + + + + + + + + + + + + + + + + + 50
Histiocytic sarcoma	+ + + + + + + + + + + + + + + + + + + + + + + 1
Lymphoma malignant	+ + + + + X + + + + + X + + + + + + + + + + 4

TABLE C2
Individual Animal Tumor Pathology of Male Mice in the 2-Year Inhalation Study of Isobutene: 500 ppm

Table with columns: Number of Days on Study, Carcass ID Number, System (Alimentary, Cardiovascular, Endocrine, General Body, Genital), Organ, and Total Tissues/Tumors. Data includes presence (+) or absence (-) of tumors in various organs across 25 mice.

TABLE C2
Individual Animal Tumor Pathology of Male Mice in the 2-Year Inhalation Study of Isobutene: 2,000 ppm

Number of Days on Study	3 3 4 4 4 5 5 5 5 5 5 5 6 6 6 6 6 6 6 6 7 7 7 7 7
	8 8 2 8 9 1 1 2 5 5 8 8 2 3 3 3 4 5 8 8 0 1 2 3 3
	7 9 8 0 9 2 2 7 5 9 3 4 8 1 6 9 5 3 1 6 8 3 9 3 3
Carcass ID Number	4 4 4 4 4 4 4 4 4 4 4 4 4 4 4 4 4 4 4 4 4 4 4 4
	2 4 3 1 2 1 2 0 0 0 1 0 1 2 3 3 4 4 2 4 2 5 4 0 0
	1 1 1 0 7 8 9 1 4 7 1 5 9 6 7 8 0 7 3 9 5 0 5 2 3
Hematopoietic System	
Bone marrow	+ + + + + + + + + + + + + + + + + + + + + + + + +
Histiocytic sarcoma	
Lymph node	
Lymph node, bronchial	+ M M + + + M + + M M + + + + + + + + + M M M M +
Lymph node, mandibular	+ + + M + M M M M + + M + + + + + + + M + M + + +
Lymph node, mesenteric	+ + + + + M + + + + + + + + + + + + + + + + + + +
Histiocytic sarcoma	
Lymph node, mediastinal	+ + + + + M + + + M + + M + M M + + M + + + + M +
Histiocytic sarcoma	
Spleen	+ + + + + + + + + + + + + + + + + + + + + + + + +
Histiocytic sarcoma	
Thymus	M + M + + + + + M M + + + M + + + M + M + M + + M
Integumentary System	
Mammary gland	M M M M M M M M M M M M M M M M M M M M M M M
Skin	+ + + + + + + + + + + + + + + + + + + + + + + + +
Subcutaneous tissue, hemangioma	
Subcutaneous tissue, sarcoma	
	X
Musculoskeletal System	
Bone	+ + + + + + + + + + + + + + + + + + + + + + + + +
Nervous System	
Brain	+ + + + + + + + + + + + + + + + + + + + + + + + +
Respiratory System	
Larynx	+ + + + + + + + + + + + + + + + + + + + + + + + +
Lung	+ + + + + + + + + + + + + + + + + + + + + + + + +
Alveolar/bronchiolar adenoma	
Alveolar/bronchiolar carcinoma	
Hepatocellular carcinoma, metastatic, liver	
Histiocytic sarcoma	
Nose	+ + + + + + + + + + + + + + + + + + + + + + + + +
Trachea	+ + + + + + + + + + + + + + + + + + + + + + + + +
Special Senses System	
Harderian gland	
Adenoma	
	+ + +
	X X X
Urinary System	
Kidney	+ + + + + + + + + + + + + + + + + + + + + + + + +
Histiocytic sarcoma	
Renal tubule, adenoma	
Urinary bladder	+ + + A + + + + + + + + + + + + + + + + + + + + +
Systemic Lesions	
Multiple organs	+ + + + + + + + + + + + + + + + + + + + + + + + +
Histiocytic sarcoma	
Lymphoma malignant	
	X X X X

**TABLE C2
Individual Animal Tumor Pathology of Male Mice in the 2-Year Inhalation Study of Isobutene: 8,000 ppm**

Number of Days on Study	7	7	7	7	7	7	7	7	7	7	7	7	7	7	7	7	7	7	7	7	7	7	7	7	
	3	3	3	3	3	3	3	3	3	3	3	3	3	3	3	3	3	3	3	3	3	3	3	3	
	3	3	3	3	3	3	3	3	3	3	3	4	4	4	4	4	4	4	4	4	4	4	4	4	
Carcass ID Number	6	6	6	6	6	6	6	6	6	6	6	6	6	6	6	6	6	6	6	6	6	6	6	Total Tissues/ Tumors	
	0	0	1	1	1	2	2	2	2	2	2	2	2	2	3	3	3	3	3	4	4	4	4		
	8	9	1	7	8	0	1	2	4	5	6	7	8	9	0	1	3	4	5	1	2	6	7	8	9
Alimentary System																									
Esophagus	+	+	+	+	+	+	+	+	+	+	+	+	+	+	+	+	+	+	+	+	+	+	+	50	
Gallbladder	+	M	M	+	+	M	+	+	+	+	+	+	+	+	+	+	+	+	+	+	+	M	+	+	34
Intestine large, colon	+	+	+	+	+	+	+	+	+	+	+	+	+	+	+	+	+	+	+	+	+	+	+	+	48
Intestine large, rectum	+	+	+	+	+	+	+	+	+	+	+	+	+	+	+	+	+	+	+	+	+	+	I	+	46
Intestine large, cecum	+	+	+	+	+	+	+	+	+	+	+	+	+	+	+	+	+	+	+	+	+	+	+	+	42
Leiomyoma																							X	1	
Intestine small, duodenum	+	+	+	+	+	+	+	+	+	+	+	+	+	+	+	+	+	+	+	+	+	+	+	+	42
Intestine small, jejunum	+	+	+	+	+	+	+	+	+	+	+	+	+	+	+	+	+	+	+	+	+	+	+	+	43
Carcinoma										X														1	
Intestine small, ileum	+	+	+	+	+	+	+	+	+	+	+	+	+	+	+	+	+	+	+	+	+	+	+	+	42
Liver	+	+	+	+	+	+	+	+	+	+	+	+	+	+	+	+	+	+	+	+	+	+	+	+	49
Hemangiosarcoma		X																						2	
Hepatocellular carcinoma									X													X		7	
Hepatocellular carcinoma, multiple			X											X										7	
Hepatocellular adenoma		X			X		X								X				X		X	X		10	
Hepatocellular adenoma, multiple	X						X	X				X					X							7	
Mesentery				+																				2	
Pancreas	+	+	+	+	+	+	+	+	+	+	+	+	I	+	+	+	+	+	+	+	+	+	+	+	47
Salivary glands	+	+	+	+	+	+	+	+	+	+	+	+	+	+	+	+	+	+	+	+	+	+	+	+	50
Stomach, forestomach	+	+	+	+	+	+	+	+	+	+	+	+	+	+	+	+	+	+	+	+	+	+	+	+	48
Stomach, glandular	+	+	+	+	+	+	+	+	+	+	+	+	+	+	+	+	+	+	+	+	+	+	+	+	46
Tooth		+		+	+	+	+	+	+	+	+									+	+	+	+	16	
Odontoma						X												X						2	
Cardiovascular System																									
Heart	+	+	+	+	+	+	+	+	+	+	+	+	+	+	+	+	+	+	+	+	+	+	+	+	50
Hemangiosarcoma																									1
Endocrine System																									
Adrenal cortex	+	+	+	+	+	+	+	+	+	+	+	+	+	+	+	+	+	+	+	+	+	+	+	+	49
Capsule, adenoma				X						X	X													3	
Adrenal medulla	+	+	+	+	+	+	+	+	+	+	+	+	+	+	+	+	+	+	+	+	+	+	+	+	49
Pheochromocytoma benign																								2	
Islets, pancreatic	+	+	+	+	+	+	+	+	+	+	+	+	+	+	+	+	+	+	+	+	+	+	+	+	48
Parathyroid gland	+	+	+	+	+	+	+	+	M	M	+	M	+	+	M	+	+	M	+	M	+	+	+	+	37
Pituitary gland	+	+	+	+	+	+	+	+	+	+	+	+	+	+	+	+	+	+	+	+	+	+	+	+	48
Pars intermedia, adenoma						X																		1	
Thyroid gland	+	+	+	+	+	+	+	+	+	+	+	+	+	+	+	+	+	+	+	+	+	+	+	+	49
General Body System																									
None																									
Genital System																									
Epididymis	+	+	+	+	+	+	+	+	+	+	+	+	+	+	+	+	+	+	+	+	+	+	+	+	50
Preputial gland	+	+	+	+	+	+	+	+	+	+	+	+	+	+	+	+	+	+	+	+	+	+	+	+	50
Prostate	+	+	+	+	+	+	+	+	+	+	+	+	+	+	+	+	+	+	+	+	+	+	+	+	48
Seminal vesicle	+	+	+	+	+	+	+	+	+	+	+	+	+	+	+	+	+	+	+	+	+	+	+	+	47
Testes	+	+	+	+	+	+	+	+	+	+	+	+	+	+	+	+	+	+	+	+	+	+	+	+	50
Interstitial cell, adenoma																						X		1	

TABLE C2
Individual Animal Tumor Pathology of Male Mice in the 2-Year Inhalation Study of Isobutene: 8,000 ppm

Number of Days on Study	2	3	3	3	4	4	5	5	5	5	5	6	6	6	6	6	6	6	6	6	7	7	7	7	7		
	5	3	4	8	5	9	0	1	4	4	6	0	3	3	3	6	7	8	8	9	0	2	3	3	3		
	1	0	1	6	7	9	8	2	7	7	2	8	1	3	9	7	0	2	9	5	6	7	3	3	3		
Carcass ID Number	6	6	6	6	6	6	6	6	6	6	6	6	6	6	6	6	6	6	6	6	6	6	6	6	6		
	4	3	0	3	1	0	5	2	1	3	1	1	4	1	4	0	3	1	1	4	3	0	0	0	0		
	4	8	3	9	0	4	0	3	2	6	6	5	5	3	0	5	7	9	4	3	2	2	1	6	7		
Hematopoietic System																											
Bone marrow	+	+	+	+	+	+	+	+	+	+	+	+	+	+	+	+	+	+	+	+	A	+	+	+	+	+	
Lymph node																					+						
Lymph node, bronchial	M	+	M	M	M	M	M	M	+	M	+	+	+	+	+	+	+	M	+	M	M	M	+	+	+	+	
Lymph node, mandibular	+	M	M	+	+	+	M	+	M	M	+	+	+	+	+	+	+	M	M	+	+	+	+	M	+	+	
Lymph node, mesenteric	+	+	+	+	+	+	+	+	+	+	+	+	+	+	+	+	+	+	+	A	+	+	+	+	+	+	
Lymph node, mediastinal	+	M	+	+	M	+	+	M	+	M	+	+	+	+	+	+	M	+	+	M	M	M	M	+	M	+	
Spleen	+	+	A	+	+	+	+	+	+	+	+	+	+	+	+	+	+	+	+	A	+	+	+	+	+	+	
Hemangiosarcoma																										X	
Histiocytic sarcoma																										X	
Thymus	+	+	+	M	+	+	+	M	+	M	+	M	+	+	+	+	M	+	A	+	+	M	+	+	+		
Integumentary System																											
Mammary gland	M	M	M	M	M	M	M	M	M	M	M	M	M	M	M	M	M	M	M	M	M	M	M	M	M	+	
Skin	+	+	+	+	+	+	+	+	+	+	+	+	+	+	+	+	+	+	+	+	+	+	+	+	+	+	
Subcutaneous tissue, sarcoma																										X	
Musculoskeletal System																											
Bone	+	+	+	+	+	+	+	+	+	+	+	+	+	+	+	+	+	+	+	+	+	+	+	+	+	+	
Nervous System																											
Brain	+	+	+	+	+	+	+	+	+	+	+	+	+	+	+	+	+	+	+	+	+	+	+	+	+	+	
Peripheral nerve																										+	
Respiratory System																											
Larynx	+	+	+	+	+	+	+	+	+	+	+	+	+	+	+	+	+	+	A	A	+	+	+	+	+	+	
Lung	+	+	+	+	+	+	+	+	+	+	+	+	+	+	+	+	+	+	+	+	+	+	+	+	+	+	
Alveolar/bronchiolar adenoma																											
Alveolar/bronchiolar carcinoma																										X	
Alveolar/bronchiolar carcinoma, multiple																											
Hepatocellular carcinoma, metastatic, liver								X		X		X															
Nose	+	+	A	+	+	+	+	+	+	+	+	+	+	+	+	+	+	+	A	+	+	+	+	+	+	+	
Trachea	+	+	+	+	+	+	+	+	+	+	+	+	+	+	+	+	+	+	A	+	+	+	+	+	+	+	
Special Senses System																											
Eye																											
Harderian gland																										+	
Adenoma																										X	
Carcinoma																											
Urinary System																											
Kidney	+	+	+	+	+	+	+	+	+	+	+	+	+	+	+	+	+	+	+	+	+	+	+	+	+	+	
Urinary bladder	A	+	A	+	+	+	+	+	+	+	+	+	+	+	+	+	+	+	A	A	+	+	+	+	+	+	
Systemic Lesions																											
Multiple organs	+	+	+	+	+	+	+	+	+	+	+	+	+	+	+	+	+	+	+	+	+	+	+	+	+	+	
Histiocytic sarcoma																										X	
Lymphoma malignant																			X	X					X		

TABLE C3
Statistical Analysis of Primary Neoplasms in Male Mice in the 2-Year Inhalation Study of Isobutene

	Chamber Control	500 ppm	2,000 ppm	8,000 ppm
Adrenal Cortex: Adenoma				
Overall rate ^a	2/49 (4%)	3/49 (6%)	1/50 (2%)	3/49 (6%)
Adjusted rate ^b	4.9%	7.0%	2.5%	7.8%
Terminal rate ^c	2/28 (7%)	3/32 (9%)	1/27 (4%)	3/28 (11%)
First incidence (days)	733 (T)	733 (T)	733 (T)	733 (T)
Poly-3 test ^d	P= 0.432	P= 0.520	P= 0.511N	P= 0.474
Harderian Gland: Adenoma				
Overall rate	3/50 (6%)	3/50 (6%)	4/50 (8%)	2/50 (4%)
Adjusted rate	7.2%	6.9%	10.0%	5.1%
Terminal rate	2/28 (7%)	3/32 (9%)	1/27 (4%)	2/28 (7%)
First incidence (days)	610	733 (T)	631	733 (T)
Poly-3 test	P= 0.434N	P= 0.643N	P= 0.480	P= 0.527N
Harderian Gland: Adenoma or Carcinoma				
Overall rate	4/50 (8%)	3/50 (6%)	4/50 (8%)	4/50 (8%)
Adjusted rate	9.6%	6.9%	10.0%	10.2%
Terminal rate	3/28 (11%)	3/32 (9%)	1/27 (4%)	4/28 (14%)
First incidence (days)	610	733 (T)	631	733 (T)
Poly-3 test	P= 0.477	P= 0.477N	P= 0.624	P= 0.612
Liver: Hepatocellular Adenoma				
Overall rate	20/50 (40%)	24/50 (48%)	18/50 (36%)	17/49 (35%)
Adjusted rate	46.9%	51.8%	43.6%	42.6%
Terminal rate	14/28 (50%)	17/32 (53%)	12/27 (44%)	13/28 (46%)
First incidence (days)	592	522	584	330
Poly-3 test	P= 0.299N	P= 0.400	P= 0.468N	P= 0.432N
Liver: Hepatocellular Carcinoma				
Overall rate	13/50 (26%)	13/50 (26%)	14/50 (28%)	14/49 (29%)
Adjusted rate	28.6%	27.4%	31.9%	31.7%
Terminal rate	2/28 (7%)	4/32 (13%)	5/27 (19%)	4/28 (14%)
First incidence (days)	399	405	389	330
Poly-3 test	P= 0.401	P= 0.541N	P= 0.453	P= 0.464
Liver: Hepatocellular Adenoma or Carcinoma				
Overall rate	30/50 (60%)	32/50 (64%)	28/50 (56%)	29/49 (59%)
Adjusted rate	64.2%	65.7%	62.4%	64.9%
Terminal rate	15/28 (54%)	19/32 (59%)	15/27 (56%)	16/28 (57%)
First incidence (days)	399	405	389	330
Poly-3 test	P= 0.549	P= 0.528	P= 0.516N	P= 0.563
Liver: Hepatocellular Carcinoma or Hepatoblastoma				
Overall rate	13/50 (26%)	13/50 (26%)	14/50 (28%)	14/49 (29%)
Adjusted rate	28.6%	27.4%	31.9%	31.7%
Terminal rate	2/28 (7%)	4/32 (13%)	5/27 (19%)	4/28 (14%)
First incidence (days)	399	405	389	330
Poly-3 test	P= 0.401	P= 0.541N	P= 0.453	P= 0.464
Liver: Hepatocellular Adenoma, Hepatocellular Carcinoma, or Hepatoblastoma				
Overall rate	30/50 (60%)	32/50 (64%)	28/50 (56%)	29/49 (59%)
Adjusted rate	64.2%	65.7%	62.4%	64.9%
Terminal rate	15/28 (54%)	19/32 (59%)	15/27 (56%)	16/28 (57%)
First incidence (days)	399	405	389	330
Poly-3 test	P= 0.549	P= 0.528	P= 0.516N	P= 0.563

TABLE C3
Statistical Analysis of Primary Neoplasms in Male Mice in the 2-Year Inhalation Study of Isobutene

	Chamber Control	500 ppm	2,000 ppm	8,000 ppm
Lung: Alveolar/bronchiolar Adenoma				
Overall rate	12/50 (24%)	7/50 (14%)	5/50 (10%)	3/50 (6%)
Adjusted rate	28.7%	16.1%	12.5%	7.6%
Terminal rate	9/28 (32%)	6/32 (19%)	4/27 (15%)	3/28 (11%)
First incidence (days)	592	698	583	733 (T)
Poly-3 test	P= 0.031N	P= 0.125N	P= 0.060N	P= 0.013N
Lung: Alveolar/bronchiolar Carcinoma				
Overall rate	6/50 (12%)	6/50 (12%)	4/50 (8%)	6/50 (12%)
Adjusted rate	14.2%	13.8%	10.1%	15.3%
Terminal rate	4/28 (14%)	6/32 (19%)	4/27 (15%)	6/28 (21%)
First incidence (days)	580	733 (T)	733 (T)	733 (T)
Poly-3 test	P= 0.490	P= 0.601N	P= 0.411N	P= 0.571
Lung: Alveolar/bronchiolar Adenoma or Carcinoma				
Overall rate	17/50 (34%)	13/50 (26%)	9/50 (18%)	9/50 (18%)
Adjusted rate	39.7%	29.8%	22.5%	22.9%
Terminal rate	12/28 (43%)	12/32 (38%)	8/27 (30%)	9/28 (32%)
First incidence (days)	580	698	583	733 (T)
Poly-3 test	P= 0.119N	P= 0.227N	P= 0.070N	P= 0.077N
Tooth: Odontoma				
Overall rate	1/50 (2%)	3/50 (6%)	2/50 (4%)	2/50 (4%)
Adjusted rate	2.4%	6.8%	5.1%	5.1%
Terminal rate	0/28 (0%)	1/32 (3%)	2/27 (7%)	2/28 (7%)
First incidence (days)	527	649	733 (T)	733 (T)
Poly-3 test	P= 0.575	P= 0.323	P= 0.479	P= 0.478
All Organs: Hemangioma or Hemangiosarcoma				
Overall rate	1/50 (2%)	1/50 (2%)	3/50 (6%)	2/50 (4%)
Adjusted rate	2.4%	2.3%	7.5%	5.1%
Terminal rate	0/28 (0%)	0/32 (0%)	2/27 (7%)	2/28 (7%)
First incidence (days)	664	715	559	733 (T)
Poly-3 test	P= 0.405	P= 0.750N	P= 0.291	P= 0.481
All Organs: Malignant Lymphoma				
Overall rate	4/50 (8%)	2/50 (4%)	5/50 (10%)	5/50 (10%)
Adjusted rate	9.6%	4.6%	12.3%	12.6%
Terminal rate	2/28 (7%)	2/32 (6%)	1/27 (4%)	3/28 (11%)
First incidence (days)	611	733 (T)	631	667
Poly-3 test	P= 0.266	P= 0.318N	P= 0.481	P= 0.469
All Organs: Benign Neoplasms				
Overall rate	30/50 (60%)	32/50 (64%)	27/50 (54%)	23/50 (46%)
Adjusted rate	68.5%	68.6%	63.6%	56.5%
Terminal rate	21/28 (75%)	24/32 (75%)	17/27 (63%)	19/28 (68%)
First incidence (days)	527	522	583	330
Poly-3 test	P= 0.115N	P= 0.591	P= 0.394N	P= 0.167N
All Organs: Malignant Neoplasms				
Overall rate	21/50 (42%)	19/50 (38%)	23/50 (46%)	23/50 (46%)
Adjusted rate	45.0%	39.7%	50.8%	50.9%
Terminal rate	7/28 (25%)	9/32 (28%)	9/27 (33%)	12/28 (43%)
First incidence (days)	399	405	389	330
Poly-3 test	P= 0.237	P= 0.376N	P= 0.363	P= 0.362

TABLE C3
Statistical Analysis of Primary Neoplasms in Male Mice in the 2-Year Inhalation Study of Isobutene

	Chamber Control	500 ppm	2,000 ppm	8,000 ppm
All Organs: Benign or Malignant Neoplasms				
Overall rate	41/50 (82%)	41/50 (82%)	36/50 (72%)	38/50 (76%)
Adjusted rate	85.0%	83.6%	78.4%	83.1%
Terminal rate	22/28 (79%)	27/32 (84%)	20/27 (74%)	24/28 (86%)
First incidence (days)	399	405	389	330
Poly-3 test	P= 0.530N	P= 0.537N	P= 0.281N	P= 0.516N

(T)Terminal sacrifice

^a Number of neoplasm-bearing animals/number of animals examined. Denominator is number of animals examined microscopically for adrenal gland, liver, and lung; for other tissues, denominator is number of animals necropsied.

^b Poly-3 estimated neoplasm incidence after adjustment for intercurrent mortality

^c Observed incidence at terminal kill

^d Beneath the chamber control incidence are the P values associated with the trend test. Beneath the exposed group incidence are the P values corresponding to pairwise comparisons between the chamber controls and that exposed group. The Poly-3 test accounts for differential mortality in animals that do not reach terminal sacrifice. A negative trend or a lower incidence in an exposure group is indicated by **N**.

TABLE C4
Summary of the Incidence of Nonneoplastic Lesions in Male Mice in the 2-Year Inhalation Study of Isobutene^a

	Chamber Control	500 ppm	2,000 ppm	8,000 ppm
Disposition Summary				
Animals initially in study	50	50	50	50
Early deaths				
Moribund	16	9	20	13
Natural deaths	6	9	3	9
Survivors				
Terminal sacrifice	28	32	27	28
Animals examined microscopically	50	50	50	50
Alimentary System				
Liver	(50)	(50)	(50)	(49)
Basophilic focus	7 (14%)	8 (16%)	6 (12%)	5 (10%)
Clear cell focus	9 (18%)	4 (8%)	6 (12%)	10 (20%)
Cyst	1 (2%)	1 (2%)		
Degeneration, fatty	2 (4%)	1 (2%)	2 (4%)	5 (10%)
Eosinophilic focus	5 (10%)	4 (8%)	11 (22%)	7 (14%)
Mixed cell focus		2 (4%)	1 (2%)	
Necrosis	1 (2%)	5 (10%)	2 (4%)	1 (2%)
Vacuolization cytoplasmic, focal	1 (2%)	1 (2%)		1 (2%)
Centrilobular, necrosis	2 (4%)			
Mesentery	(4)	(2)	(4)	(2)
Fat, inflammation, chronic active	1 (25%)			
Fat, necrosis	3 (75%)	2 (100%)	4 (100%)	2 (100%)
Pancreas	(50)	(48)	(50)	(47)
Atrophy	1 (2%)			
Basophilic focus		1 (2%)		
Stomach, forestomach	(50)	(49)	(50)	(48)
Hyperplasia	2 (4%)		1 (2%)	1 (2%)
Inflammation, acute			1 (2%)	1 (2%)
Stomach, glandular	(49)	(47)	(49)	(46)
Inflammation, acute	1 (2%)			
Necrosis		2 (4%)	1 (2%)	
Tooth	(7)	(14)	(9)	(16)
Malformation	6 (86%)	12 (86%)	7 (78%)	14 (88%)
Cardiovascular System				
Heart	(50)	(50)	(50)	(50)
Cardiomyopathy	21 (42%)	18 (36%)	16 (32%)	19 (38%)
Inflammation, chronic	1 (2%)			
Thrombosis	1 (2%)		1 (2%)	

^a Number of animals examined microscopically at the site and the number of animals with lesion

TABLE C4
Summary of the Incidence of Nonneoplastic Lesions in Male Mice in the 2-Year Inhalation Study of Isobutene

	Chamber Control	500 ppm	2,000 ppm	8,000 ppm
Endocrine System				
Adrenal cortex	(49)	(49)	(50)	(49)
Hyperplasia	14 (29%)	10 (20%)	15 (30%)	16 (33%)
Hypertrophy	32 (65%)	24 (49%)	24 (48%)	29 (59%)
Adrenal medulla	(49)	(49)	(50)	(49)
Hyperplasia			1 (2%)	1 (2%)
Islets, pancreatic	(50)	(48)	(50)	(48)
Hyperplasia	1 (2%)		1 (2%)	1 (2%)
Pituitary gland	(50)	(48)	(49)	(48)
Pars distalis, hyperplasia	1 (2%)	4 (8%)	3 (6%)	4 (8%)
Thyroid gland	(50)	(50)	(50)	(49)
Follicular cell, hyperplasia	5 (10%)	6 (12%)	3 (6%)	3 (6%)
General Body System				
None				
Genital System				
Epididymis	(50)	(50)	(50)	(50)
Granuloma sperm		1 (2%)	1 (2%)	5 (10%)
Penis			(2)	
Inflammation, acute			1 (50%)	
Preputial gland	(50)	(48)	(50)	(50)
Cyst			2 (4%)	1 (2%)
Inflammation, chronic active		2 (4%)		3 (6%)
Prostate	(48)	(46)	(47)	(48)
Inflammation, chronic active		2 (4%)	4 (9%)	4 (8%)
Seminal vesicle	(49)	(47)	(50)	(47)
Necrosis			1 (2%)	
Testes	(50)	(50)	(50)	(50)
Atrophy			1 (2%)	1 (2%)
Mineralization		1 (2%)		
Hematopoietic System				
Bone marrow	(50)	(49)	(50)	(49)
Congestion		1 (2%)		
Hemorrhage				1 (2%)
Lymph node	(4)	(3)	(7)	(1)
Iliac, infiltration cellular, plasma cell		1 (33%)	2 (29%)	1 (100%)
Iliac, infiltration cellular, polymorphonuclear			1 (14%)	
Lumbar, infiltration cellular, plasma cell		1 (33%)		
Pancreatic, infiltration cellular, plasma cell	1 (25%)			
Lymph node, mesenteric	(48)	(49)	(48)	(49)
Angiectasis	1 (2%)		1 (2%)	
Infiltration cellular, plasma cell		1 (2%)		
Spleen	(50)	(49)	(50)	(48)
Hematopoietic cell proliferation	4 (8%)	3 (6%)	5 (10%)	4 (8%)
Infiltration cellular, histiocyte		1 (2%)		1 (2%)

TABLE C4
Summary of the Incidence of Nonneoplastic Lesions in Male Mice in the 2-Year Inhalation Study of Isobutene

	Chamber Control	500 ppm	2,000 ppm	8,000 ppm
Integumentary System				
Skin	(49)	(50)	(50)	(50)
Cyst	1 (2%)			
Prepuce, inflammation, chronic active	7 (14%)	6 (12%)	13 (26%)	9 (18%)
Subcutaneous tissue, edema				1 (2%)
Musculoskeletal System				
None				
Nervous System				
Peripheral nerve				(1)
Sciatic, degeneration				1 (100%)
Respiratory System				
Lung	(50)	(50)	(50)	(50)
Hemorrhage			3 (6%)	
Thrombosis	1 (2%)	1 (2%)		
Alveolar epithelium, hyperplasia	5 (10%)	6 (12%)	4 (8%)	3 (6%)
Nose	(50)	(49)	(50)	(48)
Inflammation, suppurative	1 (2%)	2 (4%)	2 (4%)	
Polyp, inflammatory	1 (2%)			1 (2%)
Nasolacrimal duct, polyp, inflammatory				1 (2%)
Olfactory epithelium, atrophy	1 (2%)	1 (2%)	1 (2%)	2 (4%)
Olfactory epithelium, degeneration, hyaline	6 (12%)	7 (14%)	16 (32%)	17 (35%)
Respiratory epithelium, degeneration, hyaline	6 (12%)	19 (39%)	29 (58%)	39 (81%)
Special Senses System				
Eye	(2)			(2)
Cataract				1 (50%)
Cornea, inflammation, chronic active	1 (50%)			
Harderian gland	(4)	(4)	(4)	(4)
Hyperplasia		1 (25%)		
Urinary System				
Kidney	(50)	(49)	(50)	(50)
Cyst	1 (2%)			1 (2%)
Infarct	1 (2%)	2 (4%)	4 (8%)	
Inflammation, chronic active		1 (2%)		
Metaplasia, osseous	1 (2%)			2 (4%)
Mineralization	1 (2%)	1 (2%)		
Nephropathy	36 (72%)	39 (80%)	38 (76%)	40 (80%)
Capsule, inflammation, chronic			1 (2%)	
Papilla, inflammation, suppurative	3 (6%)	3 (6%)	6 (12%)	5 (10%)
Pelvis, dilatation	3 (6%)	2 (4%)	4 (8%)	4 (8%)
Renal tubule, hyperplasia	1 (2%)		1 (2%)	
Urinary bladder	(49)	(47)	(49)	(46)
Calculus, gross observation			1 (2%)	
Inflammation, chronic active	4 (8%)	3 (6%)	7 (14%)	6 (13%)

APPENDIX D
SUMMARY OF LESIONS IN FEMALE MICE
IN THE 2-YEAR INHALATION STUDY
OF ISOBUTENE

TABLE D1	Summary of the Incidence of Neoplasms in Female Mice in the 2-Year Inhalation Study of Isobutene	154
TABLE D2	Individual Animal Tumor Pathology of Female Mice in the 2-Year Inhalation Study of Isobutene	158
TABLE D3	Statistical Analysis of Primary Neoplasms in Female Mice in the 2-Year Inhalation Study of Isobutene	180
TABLE D4	Summary of the Incidence of Nonneoplastic Lesions in Female Mice in the 2-Year Inhalation Study of Isobutene	184

TABLE D1
Summary of the Incidence of Neoplasms in Female Mice in the 2-Year Inhalation Study of Isobutene^a

	Chamber Control	500 ppm	2,000 ppm	8,000 ppm
Disposition Summary				
Animals initially in study	50	50	50	50
Early deaths				
Moribund	13	16	6	13
Natural deaths	5	3	5	4
Survivors				
Terminal sacrifice	32	31	39	33
Animals examined microscopically	50	50	50	50
Alimentary System				
Intestine large, colon	(46)	(48)	(49)	(50)
Intestine large, cecum	(46)	(47)	(47)	(48)
Intestine small, jejunum	(46)	(47)	(46)	(47)
Carcinoma		1 (2%)		
Intestine small, ileum	(46)	(48)	(46)	(47)
Liver	(47)	(50)	(50)	(50)
Hepatoblastoma		1 (2%)		
Hepatoblastoma, multiple		1 (2%)		
Hepatocellular carcinoma	4 (9%)	8 (16%)	6 (12%)	9 (18%)
Hepatocellular carcinoma, multiple	1 (2%)		1 (2%)	2 (4%)
Hepatocellular adenoma	15 (32%)	18 (36%)	11 (22%)	13 (26%)
Hepatocellular adenoma, multiple	5 (11%)	4 (8%)	8 (16%)	7 (14%)
Hepatocholangiocarcinoma	1 (2%)			
Histiocytic sarcoma	2 (4%)	4 (8%)		
Mesentery	(7)	(8)	(8)	(10)
Histiocytic sarcoma		1 (13%)		
Lipoma			1 (13%)	
Pancreas	(47)	(50)	(48)	(49)
Salivary glands	(48)	(50)	(50)	(50)
Stomach, forestomach	(48)	(49)	(49)	(49)
Squamous cell carcinoma			1 (2%)	
Stomach, glandular	(46)	(48)	(48)	(49)
Squamous cell carcinoma, metastatic, stomach, forestomach			1 (2%)	
Tongue				(1)
Squamous cell papilloma				1 (100%)
Cardiovascular System				
Heart	(50)	(50)	(50)	(50)
Histiocytic sarcoma		1 (2%)		

TABLE D1
Summary of the Incidence of Neoplasms in Female Mice in the 2-Year Inhalation Study of Isobutene

	Chamber Control	500 ppm	2,000 ppm	8,000 ppm
Endocrine System				
Adrenal cortex	(49)	(50)	(49)	(50)
Hepatocellular carcinoma, metastatic, liver			1 (2%)	
Histiocytic sarcoma		1 (2%)		
Capsule, adenoma		2 (4%)		1 (2%)
Adrenal medulla	(48)	(49)	(49)	(49)
Pheochromocytoma benign		1 (2%)	2 (4%)	2 (4%)
Bilateral, pheochromocytoma malignant				1 (2%)
Islets, pancreatic	(47)	(49)	(48)	(49)
Adenoma	1 (2%)	1 (2%)	1 (2%)	
Pituitary gland	(49)	(49)	(49)	(49)
Pars distalis, adenoma	8 (16%)	13 (27%)	12 (24%)	12 (24%)
Pars distalis, carcinoma			1 (2%)	
Pars intermedia, adenoma			1 (2%)	
Thyroid gland	(48)	(50)	(49)	(50)
Follicular cell, adenoma	1 (2%)	4 (8%)	3 (6%)	1 (2%)
Follicular cell, adenoma, multiple				1 (2%)
Follicular cell, carcinoma			1 (2%)	1 (2%)
General Body System				
None				
Genital System				
Ovary	(48)	(50)	(48)	(50)
Cystadenoma		3 (6%)	1 (2%)	2 (4%)
Granulosa cell tumor benign	1 (2%)	2 (4%)		
Granulosa-theca tumor benign				1 (2%)
Hemangioma		1 (2%)	1 (2%)	
Hemangiosarcoma			1 (2%)	
Histiocytic sarcoma	2 (4%)	3 (6%)	1 (2%)	
Luteoma			1 (2%)	
Teratoma benign	1 (2%)			
Yolk sac carcinoma	1 (2%)			
Uterus	(49)	(50)	(50)	(50)
Histiocytic sarcoma		2 (4%)	1 (2%)	
Polyp stromal	2 (4%)	1 (2%)	1 (2%)	
Polyp stromal, multiple	1 (2%)			

TABLE D1
Summary of the Incidence of Neoplasms in Female Mice in the 2-Year Inhalation Study of Isobutene

	Chamber Control	500 ppm	2,000 ppm	8,000 ppm
Hematopoietic System				
Bone marrow	(48)	(49)	(49)	(50)
Hemangiosarcoma	1 (2%)			
Histiocytic sarcoma		2 (4%)		
Lymph node	(7)	(2)	(5)	(4)
Iliac, histiocytic sarcoma	1 (14%)	1 (50%)		
Inguinal, hemangiosarcoma			1 (20%)	
Renal, histiocytic sarcoma	1 (14%)	2 (100%)		
Lymph node, bronchial	(38)	(33)	(44)	(44)
Histiocytic sarcoma		1 (3%)		
Lymph node, mandibular	(41)	(42)	(44)	(38)
Histiocytic sarcoma		2 (5%)		
Lymph node, mesenteric	(46)	(48)	(47)	(49)
Histiocytic sarcoma	2 (4%)	3 (6%)		
Lymph node, mediastinal	(38)	(42)	(36)	(42)
Histiocytic sarcoma	1 (3%)	2 (5%)		
Spleen	(49)	(50)	(50)	(50)
Hemangiosarcoma	3 (6%)			1 (2%)
Hepatocholangiocarcinoma, metastatic, liver	1 (2%)			
Histiocytic sarcoma	1 (2%)	2 (4%)		
Thymus	(47)	(44)	(48)	(46)
Histiocytic sarcoma	1 (2%)			
Integumentary System				
Mammary gland	(48)	(49)	(49)	(50)
Carcinoma	2 (4%)		2 (4%)	
Skin	(49)	(50)	(49)	(50)
Subcutaneous tissue, fibrosarcoma		2 (4%)	1 (2%)	1 (2%)
Subcutaneous tissue, fibrous histiocytoma malignant		1 (2%)		
Subcutaneous tissue, hemangiosarcoma		1 (2%)	1 (2%)	
Subcutaneous tissue, sarcoma	2 (4%)	2 (4%)		2 (4%)
Musculoskeletal System				
None				
Nervous System				
Brain	(49)	(50)	(50)	(50)
Astrocytoma benign	1 (2%)			
Carcinoma, metastatic, pituitary gland			1 (2%)	

TABLE D1
Summary of the Incidence of Neoplasms in Female Mice in the 2-Year Inhalation Study of Isobutene

	Chamber Control	500 ppm	2,000 ppm	8,000 ppm
Respiratory System				
Lung	(49)	(50)	(50)	(50)
Alveolar/bronchiolar adenoma	2 (4%)	2 (4%)	2 (4%)	2 (4%)
Alveolar/bronchiolar carcinoma	4 (8%)	2 (4%)	2 (4%)	1 (2%)
Alveolar/bronchiolar carcinoma, metastatic, lung		1 (2%)		
Carcinoma, metastatic, mammary gland	1 (2%)			
Hepatoblastoma, metastatic, liver		1 (2%)		
Hepatocellular carcinoma, metastatic, liver	1 (2%)	4 (8%)	2 (4%)	1 (2%)
Histiocytic sarcoma	2 (4%)	4 (8%)		
Pheochromocytoma malignant, metastatic, adrenal medulla				1 (2%)
Sarcoma, metastatic, skin		1 (2%)		
Nose	(47)	(50)	(49)	(50)
Pleura		(1)		
Hepatoblastoma, metastatic, liver		1 (100%)		
Special Senses System				
Harderian gland	(2)	(2)	(1)	(2)
Adenoma	1 (50%)	1 (50%)	1 (100%)	1 (50%)
Carcinoma		1 (50%)		1 (50%)
Bilateral, carcinoma	1 (50%)			
Urinary System				
Kidney	(49)	(50)	(49)	(50)
Histiocytic sarcoma		3 (6%)		
Urinary bladder	(45)	(49)	(49)	(50)
Histiocytic sarcoma		1 (2%)		
Systemic Lesions				
Multiple organs ^b	(50)	(50)	(50)	(50)
Histiocytic sarcoma	2 (4%)	4 (8%)	2 (4%)	
Lymphoma malignant	16 (32%)	9 (18%)	17 (34%)	19 (38%)
Neoplasm Summary				
Total animals with primary neoplasms ^c	43	45	44	44
Total primary neoplasms	77	86	83	82
Total animals with benign neoplasms	29	35	33	32
Total benign neoplasms	39	53	46	44
Total animals with malignant neoplasms	29	29	30	31
Total malignant neoplasms	38	33	37	38
Total animals with metastatic neoplasms	3	7	4	2
Total metastatic neoplasms	3	8	5	2

^a Number of animals examined microscopically at the site and the number of animals with neoplasm

^b Number of animals with any tissue examined microscopically

^c Primary neoplasms: all neoplasms except metastatic neoplasms

**TABLE D2
Individual Animal Tumor Pathology of Female Mice in the 2-Year Inhalation Study of Isobutene: Chamber Control**

Number of Days on Study	2	3	3	4	5	5	6	6	6	6	6	6	6	6	7	7	7	7	7	7	7	7	7	7	7	7	7	7	7	7	7	7	7	7	7	7	7				
	3	2	7	4	4	8	0	1	2	3	5	6	6	6	8	0	0	2	2	3	3	3	3	3	3	3	3	3	3	3	3	3	3	3	3	3	3				
	0	2	8	9	1	0	8	0	1	9	3	7	7	1	9	9	3	3	5	5	5	5	5	5	5	5	5	5	5	5	5	5	5	5	5	5	5				
Carcass ID Number	1	1	1	1	1	1	1	1	1	1	1	1	1	1	1	1	1	1	1	1	1	1	1	1	1	1	1	1	1	1	1	1	1	1	1	1	1	1			
	4	1	2	2	3	4	0	3	0	0	2	1	4	3	0	1	2	4	0	0	0	0	0	0	0	0	0	0	0	0	0	0	0	0	0	0	0	0	0		
	0	0	4	0	7	7	8	9	6	3	7	5	4	1	4	7	6	9	1	2	5	7	9	1	2	5	7	9	1	2	5	7	9	1	2	5	7	9	1		
Alimentary System																																									
Esophagus	A	+	+	+	+	+	+	+	+	+	+	+	+	+	+	+	+	+	+	+	+	+	+	+	+	+	+	+	+	+	+	+	+	+	+	+	+	+	+		
Gallbladder	A	A	A	+	+	+	+	+	+	+	+	+	+	+	+	+	+	+	+	+	+	+	+	+	+	+	+	+	+	+	+	+	+	+	+	+	+	+	+	+	
Intestine large, colon	A	A	A	+	A	+	+	+	+	+	+	+	+	+	+	+	+	+	+	+	+	+	+	+	+	+	+	+	+	+	+	+	+	+	+	+	+	+	+	+	
Intestine large, rectum	A	A	A	+	A	+	+	+	+	+	+	+	+	+	+	+	+	+	+	I	+	+	+	+	+	+	+	+	+	+	+	+	+	+	+	+	+	+	+		
Intestine large, cecum	A	A	A	+	A	+	+	+	+	+	+	+	+	+	+	+	+	+	+	+	+	+	+	+	+	+	+	+	+	+	+	+	+	+	+	+	+	+	+	+	
Intestine small, duodenum	A	A	A	+	A	+	+	+	+	+	+	+	+	+	+	+	+	+	+	+	+	+	+	+	+	+	+	+	+	+	+	+	+	+	+	+	+	+	+	+	
Intestine small, jejunum	A	A	A	+	A	+	+	+	+	+	+	+	+	+	+	+	+	+	+	+	+	+	+	+	+	+	+	+	+	+	+	+	+	+	+	+	+	+	+	+	
Intestine small, ileum	A	A	A	+	A	+	+	+	+	+	+	+	+	+	+	+	+	+	+	+	+	+	+	+	+	+	+	+	+	+	+	+	+	+	+	+	+	+	+	+	
Liver	A	A	A	+	+	+	+	+	+	+	+	+	+	+	+	+	+	+	+	+	+	+	+	+	+	+	+	+	+	+	+	+	+	+	+	+	+	+	+	+	
Hepatocellular carcinoma																																									
Hepatocellular carcinoma, multiple								X																																	
Hepatocellular adenoma									X	X	X						X																								
Hepatocellular adenoma, multiple																																									
Hepatocholangiocarcinoma								X																																	
Histiocytic sarcoma																																									
Mesentery																																									
Pancreas	A	A	A	+	+	+	+	+	+	+	+	+	+	+	+	+	+	+	+	+	+	+	+	+	+	+	+	+	+	+	+	+	+	+	+	+	+	+	+	+	
Salivary glands	A	+	M	+	+	+	+	+	+	+	+	+	+	+	+	+	+	+	+	+	+	+	+	+	+	+	+	+	+	+	+	+	+	+	+	+	+	+	+	+	
Stomach, forestomach	A	+	A	+	+	+	+	+	+	+	+	+	+	+	+	+	+	+	+	+	+	+	+	+	+	+	+	+	+	+	+	+	+	+	+	+	+	+	+	+	
Stomach, glandular	A	A	A	+	A	+	+	+	+	+	+	+	+	+	+	+	+	+	+	+	+	+	+	+	+	+	+	+	+	+	+	+	+	+	+	+	+	+	+	+	
Cardiovascular System																																									
Heart	+	+	+	+	+	+	+	+	+	+	+	+	+	+	+	+	+	+	+	+	+	+	+	+	+	+	+	+	+	+	+	+	+	+	+	+	+	+	+	+	
Endocrine System																																									
Adrenal cortex	A	+	+	+	+	+	+	+	+	+	+	+	+	+	+	+	+	+	+	+	+	+	+	+	+	+	+	+	+	+	+	+	+	+	+	+	+	+	+	+	
Adrenal medulla	A	+	+	+	+	+	+	+	+	+	+	+	+	+	+	+	+	+	+	I	+	+	+	+	+	+	+	+	+	+	+	+	+	+	+	+	+	+	+	+	
Islets, pancreatic	A	A	A	+	+	+	+	+	+	+	+	+	+	+	+	+	+	+	+	+	+	+	+	+	+	+	+	+	+	+	+	+	+	+	+	+	+	+	+	+	+
Adenoma																																									
Parathyroid gland	A	+	+	M	M	+	+	M	+	+	+	+	+	M	+	+	+	+	M	M	+	M	+	M	+	M	+	+	+	+	+	+	+	+	+	+	+	+	+	+	
Pituitary gland	M	+	+	+	+	+	+	+	+	+	+	+	+	+	+	+	+	+	+	+	+	+	+	+	+	+	+	+	+	+	+	+	+	+	+	+	+	+	+	+	+
Pars distalis, adenoma																																									
Thyroid gland	A	+	A	+	+	+	+	+	+	+	+	+	+	+	+	+	+	+	+	+	+	+	+	+	+	+	+	+	+	+	+	+	+	+	+	+	+	+	+	+	
Follicular cell, adenoma																																									
General Body System																																									
None																																									
Genital System																																									
Clitoral gland	A	M	+	+	+	+	+	+	+	+	+	+	+	I	+	+	+	+	+	+	+	+	+	+	+	+	+	+	+	+	+	+	+	+	+	+	+	+	M	+	
Ovary	A	+	A	+	+	+	+	+	+	+	+	+	+	+	+	+	+	+	+	+	+	+	+	+	+	+	+	+	+	+	+	+	+	+	+	+	+	+	+	+	
Granulosa cell tumor benign																																									
Histiocytic sarcoma																																									
Teratoma benign																																									
Yolk sac carcinoma																																									
Uterus	A	+	+	+	+	+	+	+	+	+	+	+	+	+	+	+	+	+	+	+	+	+	+	+	+	+	+	+	+	+	+	+	+	+	+	+	+	+	+	+	
Polyp stromal																																									
Polyp stromal, multiple																																									

+ : Tissue examined microscopically M: Missing tissue X: Lesion present
 A: Autolysis precludes examination I: Insufficient tissue Blank: Not examined

TABLE D2
Individual Animal Tumor Pathology of Female Mice in the 2-Year Inhalation Study of Isobutene: Chamber Control

Number of Days on Study	7 7 7 7 7 7 7 7 7 7 7 7 7 7 7 7 7 7 7 7 7 7 7 7 7	
	3 3 3 3 3 3 3 3 3 3 3 3 3 3 3 3 3 3 3 3 3 3 3 3 3	
	5 5 5 5 5 5 5 5 5 5 5 5 6 6 6 6 6 6 6 6 6 6 6 6 6	
Carcass ID Number	1 1 1 1 1 1 1 1 1 1 1 1 1 1 1 1 1 1 1 1 1 1 1 1 1	Total
	1 1 1 1 1 2 2 2 2 2 2 3 3 3 3 3 3 3 4 4 4 4 4 4 5	Tissues/
	3 4 6 8 9 1 2 3 5 8 9 0 2 3 4 5 6 8 1 2 3 5 6 8 0	Tumors
Urinary System		
Kidney	+ + + + + + + + + + + + + + + + + + + + + + + +	49
Urinary bladder	+ + + + + + + + + + M + + + + + + + + + + + + + +	45
Systemic Lesions		
Multiple organs	+ + + + + + + + + + + + + + + + + + + + + + + +	50
Histiocytic sarcoma	X	2
Lymphoma malignant	X X	16
	X X	
	X X	

**TABLE D2
Individual Animal Tumor Pathology of Female Mice in the 2-Year Inhalation Study of Isobutene: 2,000 ppm**

Number of Days on Study	4	5	5	6	6	6	6	6	6	6	7	7	7	7	7	7	7	7	7	7	7	7	7	7	7	7
	7	0	4	0	1	2	2	7	8	9	0	3	3	3	3	3	3	3	3	3	3	3	3	3	3	3
	7	9	3	0	8	0	8	5	6	2	9	5	5	5	5	5	5	5	5	5	5	5	5	5	5	5
Carcass ID Number	5	5	5	5	5	5	5	5	5	5	5	5	5	5	5	5	5	5	5	5	5	5	5	5	5	5
	1	2	0	4	2	2	3	4	4	3	3	0	0	0	0	0	0	0	0	1	1	1	1	1	1	1
	3	3	8	9	6	1	5	1	5	4	6	1	2	3	4	5	6	7	9	0	1	2	4	5	6	6
Urinary System																										
Kidney	+	+	A	+	+	+	+	+	+	+	+	+	+	+	+	+	+	+	+	+	+	+	+	+	+	+
Urinary bladder	+	+	A	+	+	+	+	+	+	+	+	+	+	+	+	+	+	+	+	+	+	+	+	+	+	+
Systemic Lesions																										
Multiple organs	+	+	+	+	+	+	+	+	+	+	+	+	+	+	+	+	+	+	+	+	+	+	+	+	+	+
Histiocytic sarcoma									X											X						
Lymphoma malignant			X		X		X	X		X		X			X								X	X		

TABLE D3
Statistical Analysis of Primary Neoplasms in Female Mice in the 2-Year Inhalation Study of Isobutene

	Chamber Control	500 ppm	2,000 ppm	8,000 ppm
Adrenal Medulla: Benign or Malignant Pheochromocytoma				
Overall rate ^a	0/48 (0%)	1/49 (2%)	2/49 (4%)	3/49 (6%)
Adjusted rate ^b	0.0%	2.3%	4.4%	6.7%
Terminal rate ^c	0/32 (0%)	0/31 (0%)	2/39 (5%)	3/33 (9%)
First incidence (days)	— ^e	639	735 (T)	735 (T)
Poly-3 test ^d	P= 0.116	P= 0.509	P= 0.257	P= 0.133
Liver: Hepatocellular Adenoma				
Overall rate	20/47 (43%)	22/50 (44%)	19/50 (38%)	20/50 (40%)
Adjusted rate	46.3%	49.2%	40.8%	43.1%
Terminal rate	16/32 (50%)	17/31 (55%)	17/39 (44%)	16/33 (48%)
First incidence (days)	621	611	543	596
Poly-3 test	P= 0.389N	P= 0.474	P= 0.379N	P= 0.462N
Liver: Hepatocellular Carcinoma				
Overall rate	5/47 (11%)	8/50 (16%)	7/50 (14%)	11/50 (22%)
Adjusted rate	11.7%	17.7%	15.0%	22.9%
Terminal rate	4/32 (13%)	3/31 (10%)	5/39 (13%)	4/33 (12%)
First incidence (days)	610	567	600	527
Poly-3 test	P= 0.133	P= 0.315	P= 0.442	P= 0.132
Liver: Hepatocellular Adenoma or Carcinoma				
Overall rate	23/47 (49%)	28/50 (56%)	22/50 (44%)	28/50 (56%)
Adjusted rate	52.7%	60.0%	46.4%	58.1%
Terminal rate	18/32 (56%)	18/31 (58%)	18/39 (46%)	19/33 (58%)
First incidence (days)	610	567	543	527
Poly-3 test	P= 0.399	P= 0.309	P= 0.348N	P= 0.377
Liver: Hepatocellular Carcinoma or Hepatoblastoma				
Overall rate	5/47 (11%)	10/50 (20%)	7/50 (14%)	11/50 (22%)
Adjusted rate	11.7%	22.0%	15.0%	22.9%
Terminal rate	4/32 (13%)	4/31 (13%)	5/39 (13%)	4/33 (12%)
First incidence (days)	610	567	600	527
Poly-3 test	P= 0.206	P= 0.158	P= 0.442	P= 0.132
Liver: Hepatocellular Adenoma, Hepatocellular Carcinoma, or Hepatoblastoma				
Overall rate	23/47 (49%)	28/50 (56%)	22/50 (44%)	28/50 (56%)
Adjusted rate	52.7%	60.0%	46.4%	58.1%
Terminal rate	18/32 (56%)	18/31 (58%)	18/39 (46%)	19/33 (58%)
First incidence (days)	610	567	543	527
Poly-3 test	P= 0.399	P= 0.309	P= 0.348N	P= 0.377
Lung: Alveolar/bronchiolar Carcinoma				
Overall rate	4/49 (8%)	2/50 (4%)	2/50 (4%)	1/50 (2%)
Adjusted rate	9.3%	4.6%	4.4%	2.2%
Terminal rate	1/32 (3%)	1/31 (3%)	2/39 (5%)	1/33 (3%)
First incidence (days)	639	639	735 (T)	735 (T)
Poly-3 test	P= 0.193N	P= 0.331N	P= 0.311N	P= 0.161N
Lung: Alveolar/bronchiolar Adenoma or Carcinoma				
Overall rate	6/49 (12%)	4/50 (8%)	4/50 (8%)	3/50 (6%)
Adjusted rate	13.8%	9.1%	8.8%	6.5%
Terminal rate	2/32 (6%)	2/31 (6%)	4/39 (10%)	2/33 (6%)
First incidence (days)	639	639	735 (T)	701
Poly-3 test	P= 0.248N	P= 0.360N	P= 0.338N	P= 0.215N

TABLE D3
Statistical Analysis of Primary Neoplasms in Female Mice in the 2-Year Inhalation Study of Isobutene

	Chamber Control	500 ppm	2,000 ppm	8,000 ppm
Ovary: Cystadenoma				
Overall rate	0/48 (0%)	3/50 (6%)	1/48 (2%)	2/50 (4%)
Adjusted rate	0.0%	6.8%	2.3%	4.4%
Terminal rate	0/32 (0%)	1/31 (3%)	1/38 (3%)	2/33 (6%)
First incidence (days)	—	572	735 (T)	735 (T)
Poly-3 test	P= 0.486	P= 0.125	P= 0.509	P= 0.255
Pituitary Gland (Pars Distalis): Adenoma				
Overall rate	8/49 (16%)	13/49 (27%)	12/49 (24%)	12/49 (24%)
Adjusted rate	18.8%	29.8%	26.7%	26.2%
Terminal rate	6/32 (19%)	10/31 (32%)	11/39 (28%)	8/33 (24%)
First incidence (days)	709	615	709	672
Poly-3 test	P= 0.462	P= 0.171	P= 0.265	P= 0.279
Pituitary Gland (Pars Distalis): Adenoma or Carcinoma				
Overall rate	8/49 (16%)	13/49 (27%)	13/49 (27%)	12/49 (24%)
Adjusted rate	18.8%	29.8%	28.4%	26.2%
Terminal rate	6/32 (19%)	10/31 (32%)	11/39 (28%)	8/33 (24%)
First incidence (days)	709	615	477	672
Poly-3 test	P= 0.476	P= 0.171	P= 0.206	P= 0.279
Skin (Subcutaneous Tissue): Fibrous Histiocytoma, Fibrosarcoma, or Sarcoma				
Overall rate	2/50 (4%)	5/50 (10%)	1/50 (2%)	3/50 (6%)
Adjusted rate	4.7%	11.3%	2.2%	6.5%
Terminal rate	0/32 (0%)	3/31 (10%)	0/39 (0%)	1/33 (3%)
First incidence (days)	667	611	692	709
Poly-3 test	P= 0.578N	P= 0.228	P= 0.476N	P= 0.532
Spleen: Hemangiosarcoma				
Overall rate	3/49 (6%)	0/50 (0%)	0/50 (0%)	1/50 (2%)
Adjusted rate	7.1%	0.0%	0.0%	2.2%
Terminal rate	2/32 (6%)	0/31 (0%)	0/39 (0%)	1/33 (3%)
First incidence (days)	709	—	—	735 (T)
Poly-3 test	P= 0.524N	P= 0.115N	P= 0.106N	P= 0.280N
Thyroid Gland (Follicular Cell): Adenoma				
Overall rate	1/48 (2%)	4/50 (8%)	3/49 (6%)	2/50 (4%)
Adjusted rate	2.4%	9.2%	6.6%	4.4%
Terminal rate	1/32 (3%)	3/31 (10%)	3/39 (8%)	2/33 (6%)
First incidence (days)	735 (T)	695	735 (T)	735 (T)
Poly-3 test	P= 0.499N	P= 0.187	P= 0.330	P= 0.527
Thyroid Gland (Follicular Cell): Adenoma or Carcinoma				
Overall rate	1/48 (2%)	4/50 (8%)	4/49 (8%)	3/50 (6%)
Adjusted rate	2.4%	9.2%	8.8%	6.6%
Terminal rate	1/32 (3%)	3/31 (10%)	4/39 (10%)	3/33 (9%)
First incidence (days)	735 (T)	695	735 (T)	735 (T)
Poly-3 test	P= 0.558	P= 0.187	P= 0.200	P= 0.334
Uterus: Stromal Polyp				
Overall rate	3/50 (6%)	1/50 (2%)	1/50 (2%)	0/50 (0%)
Adjusted rate	7.0%	2.3%	2.2%	0.0%
Terminal rate	2/32 (6%)	1/31 (3%)	1/39 (3%)	0/33 (0%)
First incidence (days)	709	735 (T)	735 (T)	—
Poly-3 test	P= 0.132N	P= 0.298N	P= 0.280N	P= 0.106N

TABLE D3
Statistical Analysis of Primary Neoplasms in Female Mice in the 2-Year Inhalation Study of Isobutene

	Chamber Control	500 ppm	2,000 ppm	8,000 ppm
All Organs: Hemangiosarcoma				
Overall rate	3/50 (6%)	1/50 (2%)	3/50 (6%)	1/50 (2%)
Adjusted rate	7.0%	2.3%	6.5%	2.2%
Terminal rate	2/32 (6%)	1/31 (3%)	2/39 (5%)	1/33 (3%)
First incidence (days)	709	735 (T)	618	735 (T)
Poly-3 test	P= 0.323N	P= 0.298N	P= 0.625N	P= 0.280N
All Organs: Hemangioma or Hemangiosarcoma				
Overall rate	3/50 (6%)	2/50 (4%)	4/50 (8%)	1/50 (2%)
Adjusted rate	7.0%	4.6%	8.7%	2.2%
Terminal rate	2/32 (6%)	2/31 (6%)	3/39 (8%)	1/33 (3%)
First incidence (days)	709	735 (T)	618	735 (T)
Poly-3 test	P= 0.236N	P= 0.492N	P= 0.543	P= 0.280N
All Organs: Histiocytic Sarcoma				
Overall rate	2/50 (4%)	4/50 (8%)	2/50 (4%)	0/50 (0%)
Adjusted rate	4.7%	9.1%	4.3%	0.0%
Terminal rate	2/32 (6%)	2/31 (6%)	1/39 (3%)	0/33 (0%)
First incidence (days)	735 (T)	615	628	—
Poly-3 test	P= 0.077N	P= 0.354	P= 0.664N	P= 0.221N
All Organs: Malignant Lymphoma				
Overall rate	16/50 (32%)	9/50 (18%)	17/50 (34%)	19/50 (38%)
Adjusted rate	35.9%	20.4%	36.0%	40.7%
Terminal rate	12/32 (38%)	7/31 (23%)	12/39 (31%)	14/33 (42%)
First incidence (days)	378	506	543	583
Poly-3 test	P= 0.119	P= 0.079N	P= 0.582	P= 0.398
All Organs: Benign Neoplasms				
Overall rate	29/50 (58%)	35/50 (70%)	33/50 (66%)	32/50 (64%)
Adjusted rate	65.0%	74.8%	70.8%	68.4%
Terminal rate	21/32 (66%)	24/31 (77%)	30/39 (77%)	26/33 (79%)
First incidence (days)	449	572	543	596
Poly-3 test	P= 0.490N	P= 0.205	P= 0.351	P= 0.450
All Organs: Malignant Neoplasms				
Overall rate	29/50 (58%)	29/50 (58%)	30/50 (60%)	31/50 (62%)
Adjusted rate	60.9%	60.7%	60.8%	63.2%
Terminal rate	15/32 (47%)	17/31 (55%)	20/39 (51%)	18/33 (55%)
First incidence (days)	322	506	477	527
Poly-3 test	P= 0.440	P= 0.577N	P= 0.581N	P= 0.489

TABLE D3
Statistical Analysis of Primary Neoplasms in Female Mice in the 2-Year Inhalation Study of Isobutene

	Chamber Control	500 ppm	2,000 ppm	8,000 ppm
All Organs: Benign or Malignant Neoplasms				
Overall rate	43/50 (86%)	45/50 (90%)	44/50 (88%)	44/50 (88%)
Adjusted rate	87.7%	91.3%	89.2%	89.1%
Terminal rate	26/32 (81%)	28/31 (90%)	34/39 (87%)	29/33 (88%)
First incidence (days)	322	506	477	527
Poly-3 test	P= 0.568N	P= 0.397	P= 0.534	P= 0.541

(T)Terminal sacrifice

^a Number of neoplasm-bearing animals/number of animals examined. Denominator is number of animals examined microscopically for adrenal gland, liver, lung, ovary, pituitary gland, spleen, and thyroid gland; for other tissues, denominator is number of animals necropsied.

^b Poly-3 estimated neoplasm incidence after adjustment for intercurrent mortality

^c Observed incidence at terminal kill

^d Beneath the chamber control incidence are the P values associated with the trend test. Beneath the exposed group incidence are the P values corresponding to pairwise comparisons between the chamber controls and that exposed group. The Poly-3 test accounts for differential mortality in animals that do not reach terminal sacrifice. A negative trend or a lower incidence in an exposure group is indicated by **N**.

^e Not applicable; no neoplasms in animal group

TABLE D4
Summary of the Incidence of Nonneoplastic Lesions in Female Mice in the 2-Year Inhalation Study of Isobutene^a

	Chamber Control	500 ppm	2,000 ppm	8,000 ppm
Disposition Summary				
Animals initially in study	50	50	50	50
Early deaths				
Moribund	13	16	6	13
Natural deaths	5	3	5	4
Survivors				
Terminal sacrifice	32	31	39	33
Animals examined microscopically	50	50	50	50
Alimentary System				
Intestine large, rectum	(45)	(45)	(47)	(48)
Artery, inflammation, chronic active				1 (2%)
Intestine small, ileum	(46)	(48)	(46)	(47)
Inflammation, chronic active			1 (2%)	
Liver	(47)	(50)	(50)	(50)
Angiectasis	1 (2%)	1 (2%)		1 (2%)
Basophilic focus	4 (9%)	4 (8%)	2 (4%)	5 (10%)
Clear cell focus		4 (8%)	3 (6%)	4 (8%)
Cyst	1 (2%)			1 (2%)
Degeneration, fatty	2 (4%)	1 (2%)	5 (10%)	1 (2%)
Eosinophilic focus	17 (36%)	11 (22%)	12 (24%)	7 (14%)
Hematopoietic cell proliferation			1 (2%)	1 (2%)
Mixed cell focus				1 (2%)
Necrosis		2 (4%)	3 (6%)	1 (2%)
Tension lipidosis	1 (2%)	3 (6%)	1 (2%)	
Bile duct, hyperplasia			1 (2%)	
Centrilobular, necrosis			1 (2%)	3 (6%)
Mesentery	(7)	(8)	(8)	(10)
Artery, inflammation		1 (13%)		1 (10%)
Fat, inflammation, chronic active				1 (10%)
Fat, necrosis	7 (100%)	6 (75%)	6 (75%)	10 (100%)
Pancreas	(47)	(50)	(48)	(49)
Atrophy				1 (2%)
Basophilic focus	1 (2%)	2 (4%)		
Lipomatosis	1 (2%)			1 (2%)
Duct, cyst	1 (2%)	1 (2%)		
Stomach, forestomach	(48)	(49)	(49)	(49)
Hyperplasia	2 (4%)	4 (8%)	1 (2%)	1 (2%)
Inflammation, acute	1 (2%)	2 (4%)		
Stomach, glandular	(46)	(48)	(48)	(49)
Necrosis			1 (2%)	
Artery, inflammation, chronic active				1 (2%)
Tooth			(1)	(1)
Malformation			1 (100%)	1 (100%)
Cardiovascular System				
Heart	(50)	(50)	(50)	(50)
Cardiomyopathy	10 (20%)	10 (20%)	12 (24%)	8 (16%)
Mineralization		1 (2%)		

^a Number of animals examined microscopically at the site and the number of animals with lesion

TABLE D4
Summary of the Incidence of Nonneoplastic Lesions in Female Mice in the 2-Year Inhalation Study of Isobutene

	Chamber Control	500 ppm	2,000 ppm	8,000 ppm
Endocrine System				
Adrenal cortex	(49)	(50)	(49)	(50)
Hematopoietic cell proliferation	1 (2%)		1 (2%)	1 (2%)
Hyperplasia	3 (6%)	4 (8%)	3 (6%)	5 (10%)
Hypertrophy	3 (6%)	1 (2%)	4 (8%)	2 (4%)
Vacuolization cytoplasmic	1 (2%)	2 (4%)	1 (2%)	2 (4%)
Adrenal medulla	(48)	(49)	(49)	(49)
Hyperplasia		3 (6%)		
Islets, pancreatic	(47)	(49)	(48)	(49)
Hyperplasia	1 (2%)		1 (2%)	3 (6%)
Pituitary gland	(49)	(49)	(49)	(49)
Pars distalis, hyperplasia	13 (27%)	15 (31%)	19 (39%)	14 (29%)
Thyroid gland	(48)	(50)	(49)	(50)
Follicular cell, hyperplasia	25 (52%)	16 (32%)	29 (59%)	30 (60%)
General Body System				
None				
Genital System				
Ovary	(48)	(50)	(48)	(50)
Angiectasis		1 (2%)		3 (6%)
Cyst	13 (27%)	14 (28%)	11 (23%)	8 (16%)
Inflammation, suppurative	1 (2%)			
Uterus	(49)	(50)	(50)	(50)
Angiectasis				1 (2%)
Hydrometra	6 (12%)	7 (14%)	3 (6%)	4 (8%)
Inflammation, suppurative		1 (2%)	1 (2%)	
Necrosis			1 (2%)	
Thrombosis			1 (2%)	
Endometrium, hyperplasia, cystic				1 (2%)
Hematopoietic System				
Bone marrow	(48)	(49)	(49)	(50)
Necrosis		1 (2%)		
Lymph node	(7)	(2)	(5)	(4)
Lumbar, hemorrhage	1 (14%)			
Lymph node, bronchial	(38)	(33)	(44)	(44)
Hyperplasia, plasma cell	1 (3%)			
Lymph node, mandibular	(41)	(42)	(44)	(38)
Hyperplasia, lymphoid	1 (2%)			
Infiltration cellular, mixed cell			1 (2%)	
Lymph node, mesenteric	(46)	(48)	(47)	(49)
Angiectasis	1 (2%)	2 (4%)		
Infiltration cellular, plasma cell				1 (2%)
Infiltration cellular, mixed cell			1 (2%)	
Lymph node, mediastinal	(38)	(42)	(36)	(42)
Infiltration cellular, mixed cell			1 (3%)	
Spleen	(49)	(50)	(50)	(50)
Hematopoietic cell proliferation	4 (8%)	12 (24%)	6 (12%)	5 (10%)
Infarct				1 (2%)
Infiltration cellular, histiocyte		1 (2%)		

TABLE D4
Summary of the Incidence of Nonneoplastic Lesions in Female Mice in the 2-Year Inhalation Study of Isobutene

	Chamber Control	500 ppm	2,000 ppm	8,000 ppm
Integumentary System				
Skin	(49)	(50)	(49)	(50)
Inflammation, acute		1 (2%)		
Inflammation, chronic active	1 (2%)	1 (2%)		1 (2%)
Musculoskeletal System				
None				
Nervous System				
Brain	(49)	(50)	(50)	(50)
Inflammation, chronic active		1 (2%)		
Respiratory System				
Lung	(49)	(50)	(50)	(50)
Hemorrhage		1 (2%)		
Infiltration cellular, histiocyte			1 (2%)	1 (2%)
Inflammation, granulomatous				1 (2%)
Metaplasia, osseous		1 (2%)		
Alveolar epithelium, hyperplasia	4 (8%)	3 (6%)	3 (6%)	1 (2%)
Nose	(47)	(50)	(49)	(50)
Inflammation, chronic				1 (2%)
Inflammation, suppurative		1 (2%)	1 (2%)	
Olfactory epithelium, atrophy		1 (2%)		
Olfactory epithelium, degeneration, hyaline	17 (36%)	19 (38%)	24 (49%)	27 (54%)
Respiratory epithelium, degeneration, hyaline	21 (45%)	39 (78%)	41 (84%)	48 (96%)
Special Senses System				
Eye	(1)	(1)		(1)
Degeneration	1 (100%)			
Cornea, metaplasia, squamous		1 (100%)		
Urinary System				
Kidney	(49)	(50)	(49)	(50)
Amyloid deposition	1 (2%)			
Cyst		1 (2%)		
Infarct	1 (2%)	2 (4%)	1 (2%)	
Metaplasia, osseous	1 (2%)	1 (2%)	2 (4%)	
Mineralization			1 (2%)	
Nephropathy	13 (27%)	14 (28%)	18 (37%)	12 (24%)
Renal tubule, necrosis			1 (2%)	
Urinary bladder	(45)	(49)	(49)	(50)
Artery, inflammation, chronic active				1 (2%)

APPENDIX E

GENETIC TOXICOLOGY

SALMONELLA TYPHIMURIUM MUTAGENICITY TEST PROTOCOL	188
MOUSE PERIPHERAL BLOOD MICRONUCLEUS TEST PROTOCOL	188
RESULTS	189
TABLE E1 Mutagenicity of Isobutene in <i>Salmonella typhimurium</i>	190
TABLE E2 Frequency of Micronuclei in Peripheral Blood Erythrocytes of Mice Following Treatment with Isobutene by Inhalation for 14 Weeks	191

GENETIC TOXICOLOGY

SALMONELLA TYPHIMURIUM MUTAGENICITY TEST PROTOCOL

Because isobutene is a gas, it was tested in a desiccator (Zeiger *et al.*, 1992). The *Salmonella typhimurium* strains (TA97, TA98, TA100, and TA1535) and buffer or S9 mix (metabolic activation enzymes and cofactors from Aroclor 1254-induced male F344 rat or Syrian hamster liver) were incorporated into the top agar and poured onto minimal medium plates. The lids of the plates were slightly raised, and the plates were stacked in glass desiccator jars. The air was evacuated. A measured amount of isobutene was introduced, and air was allowed to enter until atmospheric pressure was reached. The desiccator was then sealed and placed in a 37° C incubator for 24 hours, after which time the desiccator was moved to a safety hood, the lid was opened, and the residual test gas was allowed to dissipate. The plates were removed from the desiccator and incubated at 37° C for an additional 24 hours. The concentration was expressed as moles of isobutene per desiccator.

Each trial consisted of triplicate plates of concurrent positive and negative controls and five doses of isobutene. The high dose of 0.027 mol/dessicator was limited by toxicity.

In this assay, a positive response is defined as a reproducible, dose-related increase in histidine-independent (revertant) colonies in any one strain/activation combination. An equivocal response is defined as an increase in revertants that is not dose related, is not reproducible, or is not of sufficient magnitude to support a determination of mutagenicity. A negative response is obtained when no increase in revertant colonies is observed following chemical treatment. There is no minimum percentage or fold increase required for a chemical to be judged positive or weakly positive.

MOUSE PERIPHERAL BLOOD MICRONUCLEUS TEST PROTOCOL

A detailed discussion of this assay is presented in MacGregor *et al.* (1990). At the end of the 14-week toxicity study, peripheral blood samples were obtained from male and female mice. Smears were immediately prepared and fixed in absolute methanol. The methanol-fixed slides were stained with acridine orange and coded. Slides were scanned to determine the frequency of micronuclei in 2,000 normochromatic erythrocytes (NCEs) in each of five male and five female mice per dose group.

The results were tabulated as the mean of the pooled results from all animals within a treatment group plus or minus the standard error of the mean. The frequency of micronucleated cells among NCEs was analyzed by a statistical software package that tested for increasing trend over exposure groups with a one-tailed Cochran-Armitage trend test, followed by pairwise comparisons between each exposed group and the control group (Margolin *et al.*, 1990). In the presence of excess binomial variation, as detected by a binomial dispersion test, the binomial variance of the Cochran-Armitage test was adjusted upward in proportion to the excess variation. In the micronucleus test, an individual trial is considered positive if the trend test P value is less than or equal to 0.025 or if the P value for any single exposed group is less than or equal to 0.025 divided by the number of exposure groups. A final call of positive for micronucleus induction is preferably based on reproducibly positive trials (as noted above). Ultimately, the final call is determined by the scientific staff after considering the results of statistical analyses, reproducibility of any effects observed, and the magnitudes of those effects.

RESULTS

Isobutene (0.001 to 0.027 mol/desiccator) was not mutagenic in *S. typhimurium* strain TA97, TA98, TA100, or TA1535, with or without induced rat or hamster liver S9 enzymes (Table E1). *In vivo*, no increase in the frequency of micronucleated NCEs was seen in peripheral blood samples from male or female mice administered isobutene via inhalation for 14 weeks (Table E2).

TABLE E1
Mutagenicity of Isobutene in *Salmonella typhimurium*^a

Strain	Concentration (mol/dessicator)	Revertants/plate ^b					
		S9		+ hamster S9		+ rat S9	
		Trial 1	Trial 2	10%	30%	10%	30%
TA100	Air	110 ± 7.5	143 ± 14.3	131 ± 2.2	127 ± 4.7	142 ± 11.0	141 ± 10.4
	0.001	98 ± 1.9	152 ± 5.3	132 ± 13.5	121 ± 8.0	131 ± 12.9	147 ± 12.5
	0.002	100 ± 4.0	151 ± 11.0	128 ± 11.6	114 ± 8.6	142 ± 1.9	124 ± 9.1
	0.007	101 ± 4.9	135 ± 2.6	130 ± 3.2	117 ± 7.2	146 ± 5.5	134 ± 4.3
	0.013	81 ± 1.9	124 ± 11.9	112 ± 11.8	87 ± 4.7	117 ± 10.6	95 ± 0.9
	0.027	68 ± 11.7	84 ± 1.2	127 ± 17.1	79 ± 5.9	89 ± 10.4	83 ± 7.2
	Trial summary	Negative	Negative	Negative	Negative	Negative	Negative
Positive control ^c	432 ± 11.8	383 ± 12.4	332 ± 15.3	859 ± 31.9	914 ± 55.4	583 ± 11.5	
TA1535	Air	10 ± 2.6	8 ± 1.5	12 ± 0.9	22 ± 4.2	15 ± 1.2	14 ± 3.2
	0.001	11 ± 1.2	10 ± 1.2	13 ± 1.3	15 ± 2.1	11 ± 1.5	20 ± 2.7
	0.002	15 ± 2.0	14 ± 2.3	10 ± 2.0	16 ± 0.9	13 ± 1.9	20 ± 3.9
	0.007	13 ± 1.0	11 ± 0.6	11 ± 1.3	16 ± 2.0	12 ± 3.2	14 ± 3.7
	0.013	10 ± 1.8	14 ± 0.9	13 ± 1.7	16 ± 1.3	13 ± 3.0	16 ± 1.9
	0.027	9 ± 0.9	13 ± 2.0	13 ± 3.1	16 ± 2.2	13 ± 2.1	13 ± 2.9
	Trial summary	Negative	Negative	Negative	Negative	Negative	Negative
Positive control	359 ± 14.5	340 ± 8.8	63 ± 4.8	129 ± 5.7	164 ± 9.6	121 ± 11.6	
TA97	Air	153 ± 7.3	153 ± 3.3	134 ± 5.5	185 ± 13.0	155 ± 5.2	212 ± 5.0
	0.001	142 ± 3.2	140 ± 7.1	136 ± 9.0	195 ± 13.3	168 ± 8.8	196 ± 1.5
	0.002	139 ± 2.7	139 ± 6.8	157 ± 16.1	194 ± 11.6	170 ± 7.6	205 ± 6.1
	0.007	135 ± 9.5	140 ± 7.5	135 ± 4.3	194 ± 3.0	162 ± 2.6	225 ± 15.9
	0.013	134 ± 4.3	155 ± 7.6	137 ± 8.0	175 ± 5.5	147 ± 8.0	209 ± 16.8
	0.027	121 ± 1.2	161 ± 6.6	125 ± 4.4	149 ± 2.0	139 ± 8.7	189 ± 13.5
	Trial summary	Negative	Negative	Negative	Negative	Negative	Negative
Positive control	583 ± 35.8	432 ± 38.4	2,035 ± 28.9	1,505 ± 74.3	942 ± 19.7	759 ± 44.8	
TA98	Air	17 ± 2.2	15 ± 2.2	24 ± 2.9	21 ± 1.5	26 ± 4.6	26 ± 5.5
	0.001	19 ± 1.5	13 ± 2.3	19 ± 1.0	23 ± 2.9	17 ± 0.6	25 ± 1.2
	0.002	17 ± 1.5	14 ± 0.7	22 ± 1.9	26 ± 3.8	17 ± 2.7	31 ± 2.9
	0.007	15 ± 0.7	14 ± 0.9	26 ± 3.8	20 ± 1.2	20 ± 2.0	29 ± 4.6
	0.013	18 ± 3.9	13 ± 0.6	19 ± 2.4	19 ± 2.7	27 ± 3.6	19 ± 4.1
	0.027	11 ± 1.5	10 ± 1.0	18 ± 2.6	14 ± 1.5	23 ± 0.3	15 ± 1.5
	Trial summary	Negative	Negative	Negative	Negative	Negative	Negative
Positive control	377 ± 14.1	316 ± 11.1	265 ± 8.0	979 ± 2.0	314 ± 22.1	321 ± 16.7	

^a Study was performed at Microbiological Associates, Inc. The detailed protocol is presented in Zeiger *et al.* (1992). Air was the control.

^b Revertants are presented as mean ± standard error from three plates.

^c The positive controls in the absence of metabolic activation were sodium azide (TA100 and TA1535), 9-aminoacridine (TA97), and 4-nitro-*o*-phenylenediamine (TA98). The positive control for metabolic activation with all strains was 2-aminoanthracene.

TABLE E2
Frequency of Micronuclei in Peripheral Blood Erythrocytes of Mice Following Treatment with Isobutene by Inhalation for 14 Weeks^a

Compound	Concentration (ppm)	Number of Mice with Erythrocytes Scored	Micronucleated NCEs/1,000 NCEs ^b	NCEs ^b (%)
Male				
Chamber Control		5	1.10 ± 0.37	97.20 ± 0.38
Isobutene	500	5	1.40 ± 0.33	97.42 ± 0.38
	1,000	5	1.70 ± 0.12	97.20 ± 0.33
	2,000	5	1.70 ± 0.20	97.68 ± 0.31
	4,000	5	1.60 ± 0.33	97.58 ± 0.51
	8,000	5	2.00 ± 0.47	97.50 ± 0.19
			P= 0.086 ^c	
Female				
Chamber Control		5	0.80 ± 0.20	97.38 ± 0.15
Isobutene	500	5	1.00 ± 0.32	97.42 ± 0.24
	1,000	5	1.10 ± 0.29	97.28 ± 0.36
	2,000	5	0.60 ± 0.10	96.38 ± 0.18
	4,000	5	1.20 ± 0.25	97.06 ± 0.33
	8,000	5	0.80 ± 0.25	96.72 ± 0.34
			P= 0.541	

^a Analysis was performed at Environmental Health Research and Testing, Inc. The detailed protocol is presented in MacGregor *et al.* (1990).

NCE= normochromatic erythrocyte

^b Mean ± standard error

^c Significance of micronucleated NCEs/1,000 NCEs tested by the one-tailed trend test, significant at P 0.025 (Margolin *et al.*, 1990)

APPENDIX F HEMATOLOGY AND CLINICAL CHEMISTRY RESULTS

TABLE F1	Hematology and Clinical Chemistry Data for Rats in the 14-Week Inhalation Study of Isobutene	194
-----------------	-----------------------------------------------------------------------------------------------------------	------------

TABLE F1
Hematology and Clinical Chemistry Data for Rats in the 14-Week Inhalation Study of Isobutene^a

	Chamber Control	500 ppm	1,000 ppm	2,000 ppm	4,000 ppm	8,000 ppm
Male						
Hematology						
n	10	10	10	10	10	10
Automated hematocrit (%)						
Day 3	41.6 ± 0.3	41.8 ± 0.4	41.5 ± 0.5	41.5 ± 0.7	42.0 ± 0.5	42.1 ± 0.5
Day 23	45.7 ± 0.7	45.0 ± 0.4	44.4 ± 0.5	45.4 ± 0.2	45.6 ± 0.3	45.5 ± 0.4
Week 14	45.8 ± 0.4	45.4 ± 0.3	44.9 ± 0.3	45.4 ± 0.4	45.8 ± 0.4	45.1 ± 0.4
Manual hematocrit (%)						
Day 3	42.5 ± 0.3	42.6 ± 0.4	42.8 ± 0.4	42.2 ± 0.6	43.3 ± 0.4	43.4 ± 0.4
Day 23	46.6 ± 0.7	45.9 ± 0.5	45.4 ± 0.6	46.2 ± 0.3	46.4 ± 0.3	46.5 ± 0.3
Week 14	46.3 ± 0.4	46.8 ± 0.9	45.5 ± 0.3	45.9 ± 0.4	46.6 ± 0.3	46.0 ± 0.3
Hemoglobin (g/dL)						
Day 3	13.9 ± 0.1	14.1 ± 0.1	13.8 ± 0.2	13.7 ± 0.2	14.0 ± 0.1	13.8 ± 0.2
Day 23	16.0 ± 0.2	15.7 ± 0.2	15.6 ± 0.2	15.8 ± 0.1	15.7 ± 0.1	15.8 ± 0.1
Week 14	15.4 ± 0.1	15.3 ± 0.1	15.2 ± 0.1	15.2 ± 0.1	15.3 ± 0.1	15.2 ± 0.1
Erythrocytes (10 ⁶ /μL)						
Day 3	7.47 ± 0.11	7.55 ± 0.11	7.41 ± 0.12	7.33 ± 0.17	7.50 ± 0.12	7.37 ± 0.12
Day 23	8.64 ± 0.11	8.55 ± 0.12	8.34 ± 0.11	8.50 ± 0.09	8.51 ± 0.06	8.56 ± 0.09
Week 14	9.18 ± 0.05	9.08 ± 0.06	9.03 ± 0.06	9.05 ± 0.06	9.12 ± 0.06	9.03 ± 0.08
Reticulocytes (10 ⁶ /μL)						
Day 3	0.24 ± 0.05	0.17 ± 0.03	0.18 ± 0.03	0.12 ± 0.02	0.16 ± 0.05	0.27 ± 0.03
Day 23	0.10 ± 0.02 ^b	0.09 ± 0.02 ^b	0.07 ± 0.02	0.09 ± 0.02 ^b	0.13 ± 0.03	0.12 ± 0.02 ^b
Week 14	0.07 ± 0.01	0.05 ± 0.01	0.06 ± 0.01	0.07 ± 0.01	0.06 ± 0.01	0.06 ± 0.01
Nucleated erythrocytes (10 ³ /μL)						
Day 3	0.11 ± 0.03	0.07 ± 0.02	0.08 ± 0.03	0.09 ± 0.03	0.11 ± 0.04	0.14 ± 0.05
Day 23	0.02 ± 0.01	0.01 ± 0.01	0.04 ± 0.02	0.02 ± 0.01	0.01 ± 0.01	0.01 ± 0.01
Week 14	0.03 ± 0.01	0.03 ± 0.02	0.04 ± 0.02	0.02 ± 0.01	0.03 ± 0.02	0.02 ± 0.02
Mean cell volume (fL)						
Day 3	55.5 ± 0.7	55.4 ± 0.6	55.9 ± 0.5	56.8 ± 0.6	56.1 ± 0.3	57.2 ± 0.4
Day 23	52.8 ± 0.4	52.6 ± 0.4	53.2 ± 0.4	53.3 ± 0.4	53.5 ± 0.4	53.1 ± 0.5
Week 14	49.9 ± 0.3	50.0 ± 0.3	49.8 ± 0.3	50.2 ± 0.2	50.1 ± 0.3	50.1 ± 0.4
Mean cell hemoglobin (pg)						
Day 3	18.6 ± 0.1	18.7 ± 0.1	18.7 ± 0.1	18.7 ± 0.2	18.7 ± 0.1	18.7 ± 0.1
Day 23	18.5 ± 0.1	18.4 ± 0.1	18.7 ± 0.1	18.6 ± 0.2	18.5 ± 0.1	18.5 ± 0.1
Week 14	16.8 ± 0.0	16.9 ± 0.1	16.8 ± 0.0	16.8 ± 0.0	16.8 ± 0.0	16.8 ± 0.1
Mean cell hemoglobin concentration (g/dL)						
Day 3	33.4 ± 0.2	33.6 ± 0.1	33.4 ± 0.2	32.9 ± 0.2	33.3 ± 0.2	32.7 ± 0.1**
Day 23	35.1 ± 0.2	34.9 ± 0.2	35.1 ± 0.1	34.8 ± 0.1	34.5 ± 0.2	34.8 ± 0.2
Week 14	33.7 ± 0.2	33.7 ± 0.2	33.7 ± 0.3	33.5 ± 0.1	33.5 ± 0.1	33.6 ± 0.3
Platelets (10 ³ /μL)						
Day 3	922.4 ± 25.1	878.9 ± 26.9	874.8 ± 43.1	815.7 ± 14.4*	836.6 ± 33.9	851.0 ± 14.6
Day 23	680.2 ± 19.2	672.0 ± 13.6	669.8 ± 14.2	646.3 ± 24.1	681.5 ± 17.9	642.8 ± 30.8
Week 14	515.5 ± 10.4	530.9 ± 12.0	535.1 ± 7.3	501.6 ± 7.4	525.9 ± 5.3	541.2 ± 7.9
Leukocytes (10 ³ /μL)						
Day 3	7.85 ± 0.39	8.76 ± 0.36	8.71 ± 0.31	8.55 ± 0.32	7.84 ± 0.48	7.86 ± 0.34
Day 23	5.56 ± 0.55	6.12 ± 0.18	5.85 ± 0.35	6.08 ± 0.45	5.87 ± 0.45	6.61 ± 0.35
Week 14	5.73 ± 0.39	6.14 ± 0.27	6.13 ± 0.36	6.73 ± 0.30	6.04 ± 0.36	5.69 ± 0.37
Segmented neutrophils (10 ³ /μL)						
Day 3	0.80 ± 0.09	0.74 ± 0.11	0.91 ± 0.12	0.77 ± 0.10	0.74 ± 0.10	0.92 ± 0.08
Day 23	0.82 ± 0.14	0.90 ± 0.09	0.78 ± 0.07	0.83 ± 0.07	0.73 ± 0.07	0.84 ± 0.10
Week 14	0.93 ± 0.08	1.17 ± 0.10	1.33 ± 0.12	0.95 ± 0.12	1.07 ± 0.10	1.02 ± 0.11
Lymphocytes (10 ³ /μL)						
Day 3	6.81 ± 0.34	7.88 ± 0.35	7.74 ± 0.26	7.72 ± 0.24	6.87 ± 0.44	6.81 ± 0.31
Day 23	4.68 ± 0.48	5.20 ± 0.13	5.03 ± 0.37	5.21 ± 0.42	5.11 ± 0.42	5.73 ± 0.38
Week 14	4.70 ± 0.35	4.86 ± 0.24	4.70 ± 0.30	5.71 ± 0.25	4.93 ± 0.34	4.59 ± 0.32

TABLE F1
Hematology and Clinical Chemistry Data for Rats in the 14-Week Inhalation Study of Isobutene

	Chamber Control	500 ppm	1,000 ppm	2,000 ppm	4,000 ppm	8,000 ppm
Male (continued)						
Hematology (continued)						
n	10	10	10	10	10	10
Monocytes ($10^3/\mu\text{L}$)						
Day 3	0.20 ± 0.05	0.12 ± 0.04	0.06 ± 0.03	0.02 ± 0.01**	0.15 ± 0.04	0.12 ± 0.03
Day 23	0.04 ± 0.02	0.01 ± 0.01	0.02 ± 0.02	0.03 ± 0.03	0.01 ± 0.01	0.01 ± 0.01
Week 14	0.06 ± 0.02	0.05 ± 0.02	0.06 ± 0.02	0.04 ± 0.02	0.03 ± 0.01	0.05 ± 0.02
Eosinophils ($10^3/\mu\text{L}$)						
Day 3	0.03 ± 0.02	0.02 ± 0.02	0.01 ± 0.01	0.03 ± 0.02	0.07 ± 0.02	0.02 ± 0.01
Day 23	0.03 ± 0.01	0.01 ± 0.01	0.02 ± 0.01	0.00 ± 0.00	0.02 ± 0.01	0.03 ± 0.01
Week 14	0.05 ± 0.02	0.06 ± 0.02	0.04 ± 0.02	0.03 ± 0.02	0.01 ± 0.01	0.03 ± 0.02
Clinical Chemistry						
n						
Day 3	10	10	10	10	9	10
Day 23	10	10	10	10	10	10
Week 14	10	10	10	10	10	10
Urea nitrogen (mg/dL)						
Day 3	12.7 ± 0.7	14.2 ± 0.6	12.3 ± 0.4	11.1 ± 0.5	11.9 ± 0.6	11.5 ± 0.5
Day 23	15.6 ± 0.4	14.7 ± 0.3	14.6 ± 0.3	15.2 ± 0.5	14.9 ± 0.2	14.6 ± 0.2
Week 14	20.6 ± 0.7	19.7 ± 0.6	18.8 ± 0.7	20.4 ± 0.7	19.6 ± 0.8	19.2 ± 0.6
Creatinine (mg/dL)						
Day 3	0.61 ± 0.05	0.62 ± 0.02	0.56 ± 0.03	0.47 ± 0.02**	0.53 ± 0.04*	0.51 ± 0.02*
Day 23	0.73 ± 0.02	0.72 ± 0.01	0.71 ± 0.02	0.70 ± 0.02	0.72 ± 0.01	0.71 ± 0.02
Week 14	0.86 ± 0.02	0.88 ± 0.02	0.89 ± 0.01	0.86 ± 0.02	0.86 ± 0.02	0.84 ± 0.02
Serum glucose (mg/dL)						
Day 3	146 ± 4	158 ± 2	162 ± 4	162 ± 4*	147 ± 3	138 ± 2
Day 23	157 ± 4	156 ± 10	157 ± 4	150 ± 3	153 ± 2	155 ± 5
Week 14	153 ± 7	185 ± 12	158 ± 5	171 ± 11	178 ± 13	166 ± 10
Total protein (g/dL)						
Day 3	6.2 ± 0.1	6.5 ± 0.1	6.2 ± 0.1	6.0 ± 0.1	6.0 ± 0.1	6.1 ± 0.1
Day 23	6.8 ± 0.1	6.6 ± 0.1	6.7 ± 0.1	6.8 ± 0.1	6.7 ± 0.1	6.6 ± 0.1
Week 14	7.6 ± 0.1	7.6 ± 0.1	7.7 ± 0.1	7.5 ± 0.1	7.7 ± 0.1	7.5 ± 0.1
Albumin (g/dL)						
Day 3	5.0 ± 0.1	5.3 ± 0.1	5.1 ± 0.1	4.8 ± 0.1	4.9 ± 0.1	5.0 ± 0.1
Day 23	4.9 ± 0.1	4.9 ± 0.1	4.9 ± 0.1	5.0 ± 0.1	4.9 ± 0.1	4.9 ± 0.1
Week 14	4.8 ± 0.1	4.9 ± 0.1	4.9 ± 0.1	4.8 ± 0.1	4.8 ± 0.1	4.8 ± 0.1
Globulin (g/dL)						
Day 3	1.1 ± 0.1	1.2 ± 0.1	1.1 ± 0.0	1.1 ± 0.1	1.2 ± 0.1	1.1 ± 0.0
Day 23	1.9 ± 0.1	1.7 ± 0.1	1.8 ± 0.1	1.8 ± 0.1	1.8 ± 0.1	1.7 ± 0.1
Week 14	2.8 ± 0.1	2.7 ± 0.1	2.9 ± 0.1	2.7 ± 0.1	2.9 ± 0.0	2.7 ± 0.1
A/G ratio						
Day 3	4.5 ± 0.3	4.6 ± 0.3	4.9 ± 0.3	4.4 ± 0.2	4.4 ± 0.3	4.4 ± 0.2
Day 23	2.7 ± 0.2	2.9 ± 0.2	2.9 ± 0.2	2.8 ± 0.1	2.8 ± 0.2	3.0 ± 0.2
Week 14	1.7 ± 0.1	1.8 ± 0.0	1.7 ± 0.1	1.8 ± 0.1	1.7 ± 0.0	1.8 ± 0.1

TABLE F1
Hematology and Clinical Chemistry Data for Rats in the 14-Week Inhalation Study of Isobutene

	Chamber Control	500 ppm	1,000 ppm	2,000 ppm	4,000 ppm	8,000 ppm
Female (continued)						
n	10	10	10	10	10	10
Hematology (continued)						
Nucleated erythrocytes ($10^3/\mu\text{L}$)						
Day 3	0.05 ± 0.02	0.05 ± 0.02	0.06 ± 0.02	0.06 ± 0.03	0.04 ± 0.02	0.07 ± 0.04
Day 23	0.03 ± 0.01	0.02 ± 0.02	0.01 ± 0.01	0.02 ± 0.01	0.02 ± 0.01	0.00 ± 0.00
Week 14	0.03 ± 0.01	0.01 ± 0.01	0.02 ± 0.01	0.04 ± 0.01	0.01 ± 0.01	0.01 ± 0.01
Mean cell volume (fL)						
Day 3	55.3 ± 0.4	56.5 ± 0.4	55.3 ± 0.7	57.1 ± 0.3*	56.4 ± 0.3	56.3 ± 0.6
Day 23	56.0 ± 0.4	55.6 ± 0.5	55.7 ± 0.4	55.9 ± 0.4	55.3 ± 0.3	56.4 ± 0.3
Week 14	53.4 ± 0.3	53.6 ± 0.2	53.2 ± 0.3	53.2 ± 0.2	53.3 ± 0.2	53.6 ± 0.2
Mean cell hemoglobin (pg)						
Day 3	18.9 ± 0.1	19.0 ± 0.1	18.8 ± 0.1	18.8 ± 0.1	18.7 ± 0.1	18.8 ± 0.1
Day 23	18.9 ± 0.1	19.0 ± 0.1	18.9 ± 0.1	18.9 ± 0.1	18.8 ± 0.1	19.0 ± 0.1
Week 14	18.2 ± 0.1	18.2 ± 0.1	18.1 ± 0.1	18.1 ± 0.0	18.2 ± 0.1	18.3 ± 0.1
Mean cell hemoglobin concentration (g/dL)						
Day 3	34.1 ± 0.2	33.7 ± 0.3	34.1 ± 0.4	32.9 ± 0.2*	33.3 ± 0.1	33.5 ± 0.3
Day 23	34.0 ± 0.3	34.1 ± 0.2	33.9 ± 0.3	33.8 ± 0.2	34.0 ± 0.1	33.5 ± 0.2
Week 14	34.1 ± 0.2	34.1 ± 0.1	34.1 ± 0.1	34.1 ± 0.2	34.2 ± 0.1	34.0 ± 0.2
Platelets ($10^3/\mu\text{L}$)						
Day 3	797.5 ± 48.0	861.6 ± 63.7	831.0 ± 40.1	871.7 ± 39.4	840.8 ± 54.6	791.4 ± 32.1
Day 23	705.0 ± 21.4	675.0 ± 30.5	754.5 ± 35.2	721.4 ± 20.5	707.4 ± 11.4	745.5 ± 19.9
Week 14	599.4 ± 16.2	615.8 ± 26.6	570.2 ± 24.2	530.5 ± 13.4*	575.8 ± 15.1	603.8 ± 19.2
Leukocytes ($10^3/\mu\text{L}$)						
Day 3	8.24 ± 0.39	8.61 ± 0.25	8.45 ± 0.38	8.90 ± 0.28	9.94 ± 0.54*	9.34 ± 0.43*
Day 23	5.44 ± 0.36	6.26 ± 0.57	5.68 ± 0.34	5.76 ± 0.31	5.97 ± 0.60	5.74 ± 0.43
Week 14	6.71 ± 0.14	6.95 ± 0.27	6.92 ± 0.45	6.95 ± 0.20	7.26 ± 0.39	6.43 ± 0.40
Segmented neutrophils ($10^3/\mu\text{L}$)						
Day 3	0.78 ± 0.10	0.77 ± 0.10	0.79 ± 0.10	0.78 ± 0.08	1.16 ± 0.13	0.97 ± 0.19
Day 23	0.72 ± 0.08	0.76 ± 0.12	0.76 ± 0.08	0.76 ± 0.09	0.99 ± 0.12	0.81 ± 0.09
Week 14	1.03 ± 0.10	0.86 ± 0.08	1.22 ± 0.15	0.95 ± 0.08	1.40 ± 0.12	1.05 ± 0.14
Lymphocytes ($10^3/\mu\text{L}$)						
Day 3	7.33 ± 0.39	7.70 ± 0.20	7.54 ± 0.37	7.99 ± 0.28	8.71 ± 0.46	8.28 ± 0.36
Day 23	4.65 ± 0.33	5.42 ± 0.49	4.81 ± 0.31	4.95 ± 0.33	4.90 ± 0.52	4.87 ± 0.49
Week 14	5.59 ± 0.17	6.02 ± 0.27	5.62 ± 0.32	5.90 ± 0.20	5.76 ± 0.35	5.29 ± 0.31
Monocytes ($10^3/\mu\text{L}$)						
Day 3	0.09 ± 0.04	0.11 ± 0.04	0.09 ± 0.03	0.07 ± 0.04	0.03 ± 0.02	0.04 ± 0.03
Day 23	0.02 ± 0.01	0.02 ± 0.01	0.02 ± 0.01	0.01 ± 0.01	0.00 ± 0.00	0.01 ± 0.01
Week 14	0.04 ± 0.02	0.03 ± 0.02	0.04 ± 0.02	0.05 ± 0.02	0.05 ± 0.02	0.03 ± 0.01
Eosinophils ($10^3/\mu\text{L}$)						
Day 3	0.04 ± 0.02	0.03 ± 0.01	0.04 ± 0.02	0.05 ± 0.02	0.05 ± 0.02	0.05 ± 0.02
Day 23	0.05 ± 0.02	0.06 ± 0.02	0.07 ± 0.02	0.03 ± 0.01	0.07 ± 0.02	0.03 ± 0.01
Week 14	0.05 ± 0.02	0.04 ± 0.01	0.04 ± 0.02	0.06 ± 0.02	0.05 ± 0.02	0.08 ± 0.02
Clinical Chemistry						
Urea nitrogen (mg/dL)						
Day 3	18.3 ± 1.1	13.4 ± 0.5**	14.6 ± 0.7**	14.1 ± 0.3**	13.5 ± 0.5**	12.9 ± 0.5**
Day 23	14.3 ± 0.4	14.6 ± 0.6	14.0 ± 0.5	13.5 ± 0.6	13.7 ± 0.4	13.1 ± 0.3
Week 14	19.4 ± 1.0	20.0 ± 0.7	20.0 ± 0.8	19.2 ± 1.1	19.7 ± 0.5	19.0 ± 0.8
Creatinine (mg/dL)						
Day 3	0.63 ± 0.02	0.63 ± 0.02	0.59 ± 0.02	0.55 ± 0.02**	0.59 ± 0.02*	0.58 ± 0.03*
Day 23	0.76 ± 0.02	0.84 ± 0.02	0.77 ± 0.03	0.76 ± 0.02	0.77 ± 0.02	0.75 ± 0.02
Week 14	0.83 ± 0.03	0.81 ± 0.03	0.85 ± 0.02	0.84 ± 0.02	0.83 ± 0.03	0.80 ± 0.02

TABLE F1
Hematology and Clinical Chemistry Data for Rats in the 14-Week Inhalation Study of Isobutene

	Chamber Control	500 ppm	1,000 ppm	2,000 ppm	4,000 ppm	8,000 ppm
Female (continued)						
n	10	10	10	10	10	10
Clinical Chemistry (continued)						
Serum glucose (mg/dL)						
Day 3	124 ± 4	136 ± 6	141 ± 9	128 ± 3	127 ± 4	122 ± 4
Day 23	155 ± 4	171 ± 13	166 ± 8	148 ± 6	158 ± 3	164 ± 5
Week 14	164 ± 5	169 ± 11	176 ± 10	170 ± 7	167 ± 4	169 ± 5
Total protein (g/dL)						
Day 3	6.1 ± 0.1	6.1 ± 0.1	6.0 ± 0.1	6.0 ± 0.1	6.0 ± 0.1	6.1 ± 0.1
Day 23	6.5 ± 0.1	6.6 ± 0.1	6.5 ± 0.1	6.4 ± 0.1	6.5 ± 0.1	6.6 ± 0.1
Week 14	7.3 ± 0.1	7.5 ± 0.1	7.6 ± 0.1	7.3 ± 0.1	7.3 ± 0.1	7.3 ± 0.1
Albumin (g/dL)						
Day 3	5.4 ± 0.1	5.7 ± 0.1	5.5 ± 0.1	5.5 ± 0.0	5.4 ± 0.1	5.3 ± 0.1
Day 23	4.7 ± 0.1	4.8 ± 0.1	4.8 ± 0.1	4.7 ± 0.0	4.8 ± 0.1	4.7 ± 0.1
Week 14	5.1 ± 0.1	5.2 ± 0.1	5.1 ± 0.1	5.1 ± 0.1	5.0 ± 0.1	5.0 ± 0.1
Globulin (g/dL)						
Day 3	0.7 ± 0.1	0.5 ± 0.1	0.5 ± 0.1	0.5 ± 0.0*	0.6 ± 0.1	0.8 ± 0.1
Day 23	1.8 ± 0.1	1.8 ± 0.1	1.8 ± 0.1	1.7 ± 0.1	1.7 ± 0.0	1.8 ± 0.1
Week 14	2.2 ± 0.1	2.3 ± 0.1	2.5 ± 0.1	2.3 ± 0.1	2.4 ± 0.1	2.3 ± 0.1
A/G ratio						
Day 3	8.1 ± 0.8	14.5 ± 2.7 ^b	12.8 ± 2.0	13.1 ± 1.1	9.9 ± 1.3	7.5 ± 1.0
Day 23	2.7 ± 0.1	2.6 ± 0.1	2.7 ± 0.1	2.9 ± 0.1	2.8 ± 0.1	2.6 ± 0.1
Week 14	2.4 ± 0.1	2.3 ± 0.1	2.1 ± 0.1	2.3 ± 0.1	2.1 ± 0.1	2.3 ± 0.1
Alanine aminotransferase (IU/L)						
Day 3	34 ± 1	34 ± 1	35 ± 2	34 ± 1	33 ± 1	33 ± 1
Day 23	30 ± 1	34 ± 3	30 ± 1	29 ± 1	29 ± 1	30 ± 1
Week 14	47 ± 2	65 ± 6*	55 ± 3	66 ± 7*	54 ± 5	60 ± 4
Alkaline phosphatase (IU/L)						
Day 3	583 ± 22	577 ± 21	569 ± 32	539 ± 20	486 ± 18*	554 ± 26
Day 23	347 ± 10	391 ± 10*	366 ± 12	366 ± 9	330 ± 10	347 ± 8
Week 14	307 ± 15	328 ± 11	369 ± 14*	317 ± 15	321 ± 12	306 ± 13
Creatine kinase (IU/L)						
Day 3	204 ± 16	222 ± 12	210 ± 24	198 ± 18	205 ± 26	277 ± 36
Day 23	197 ± 35	196 ± 24	162 ± 20	202 ± 27	183 ± 28	221 ± 59
Week 14	109 ± 9	122 ± 20	112 ± 12	139 ± 17	134 ± 14	146 ± 13
Sorbitol dehydrogenase (IU/L)						
Day 3	16 ± 0	16 ± 1	14 ± 1*	14 ± 0**	15 ± 1*	14 ± 1*
Day 23	15 ± 1	19 ± 2	14 ± 1	16 ± 1	15 ± 1	16 ± 0
Week 14	14 ± 1	17 ± 1	17 ± 1	17 ± 1	15 ± 2	17 ± 1
Bile acids (µmol/L)						
Day 3	17.9 ± 1.9	13.6 ± 1.3	20.0 ± 3.7	17.8 ± 1.3	16.1 ± 1.2	16.1 ± 1.2
Day 23	14.6 ± 0.7	21.7 ± 5.7	18.0 ± 2.0	14.7 ± 1.1	14.2 ± 0.6	16.6 ± 1.4
Week 14	24.8 ± 3.5	24.5 ± 3.4	30.5 ± 6.1	40.1 ± 5.6	32.6 ± 5.4	30.4 ± 4.2

* Significantly different ($P \leq 0.05$) from the chamber control group by Dunn's or Shirley's test

** $P \leq 0.01$

^a Mean ± standard error. Statistical tests were performed on unrounded data.

^b n=9

^c n=8

TABLE F1
Hematology and Clinical Chemistry Data for Rats in the 14-Week Inhalation Study of Isobutene^a

	Chamber Control	500 ppm	1,000 ppm	2,000 ppm	4,000 ppm	8,000 ppm
Male						
Hematology						
n	10	10	10	10	10	10
Automated hematocrit (%)						
Day 3	41.6 ± 0.3	41.8 ± 0.4	41.5 ± 0.5	41.5 ± 0.7	42.0 ± 0.5	42.1 ± 0.5
Day 23	45.7 ± 0.7	45.0 ± 0.4	44.4 ± 0.5	45.4 ± 0.2	45.6 ± 0.3	45.5 ± 0.4
Week 14	45.8 ± 0.4	45.4 ± 0.3	44.9 ± 0.3	45.4 ± 0.4	45.8 ± 0.4	45.1 ± 0.4
Manual hematocrit (%)						
Day 3	42.5 ± 0.3	42.6 ± 0.4	42.8 ± 0.4	42.2 ± 0.6	43.3 ± 0.4	43.4 ± 0.4
Day 23	46.6 ± 0.7	45.9 ± 0.5	45.4 ± 0.6	46.2 ± 0.3	46.4 ± 0.3	46.5 ± 0.3
Week 14	46.3 ± 0.4	46.8 ± 0.9	45.5 ± 0.3	45.9 ± 0.4	46.6 ± 0.3	46.0 ± 0.3
Hemoglobin (g/dL)						
Day 3	13.9 ± 0.1	14.1 ± 0.1	13.8 ± 0.2	13.7 ± 0.2	14.0 ± 0.1	13.8 ± 0.2
Day 23	16.0 ± 0.2	15.7 ± 0.2	15.6 ± 0.2	15.8 ± 0.1	15.7 ± 0.1	15.8 ± 0.1
Week 14	15.4 ± 0.1	15.3 ± 0.1	15.2 ± 0.1	15.2 ± 0.1	15.3 ± 0.1	15.2 ± 0.1
Erythrocytes (10 ⁶ /μL)						
Day 3	7.47 ± 0.11	7.55 ± 0.11	7.41 ± 0.12	7.33 ± 0.17	7.50 ± 0.12	7.37 ± 0.12
Day 23	8.64 ± 0.11	8.55 ± 0.12	8.34 ± 0.11	8.50 ± 0.09	8.51 ± 0.06	8.56 ± 0.09
Week 14	9.18 ± 0.05	9.08 ± 0.06	9.03 ± 0.06	9.05 ± 0.06	9.12 ± 0.06	9.03 ± 0.08
Reticulocytes (10 ⁶ /μL)						
Day 3	0.24 ± 0.05	0.17 ± 0.03	0.18 ± 0.03	0.12 ± 0.02	0.16 ± 0.05	0.27 ± 0.03
Day 23	0.10 ± 0.02 ^b	0.09 ± 0.02 ^b	0.07 ± 0.02	0.09 ± 0.02 ^b	0.13 ± 0.03	0.12 ± 0.02 ^b
Week 14	0.07 ± 0.01	0.05 ± 0.01	0.06 ± 0.01	0.07 ± 0.01	0.06 ± 0.01	0.06 ± 0.01
Nucleated erythrocytes (10 ³ /μL)						
Day 3	0.11 ± 0.03	0.07 ± 0.02	0.08 ± 0.03	0.09 ± 0.03	0.11 ± 0.04	0.14 ± 0.05
Day 23	0.02 ± 0.01	0.01 ± 0.01	0.04 ± 0.02	0.02 ± 0.01	0.01 ± 0.01	0.01 ± 0.01
Week 14	0.03 ± 0.01	0.03 ± 0.02	0.04 ± 0.02	0.02 ± 0.01	0.03 ± 0.02	0.02 ± 0.02
Mean cell volume (fL)						
Day 3	55.5 ± 0.7	55.4 ± 0.6	55.9 ± 0.5	56.8 ± 0.6	56.1 ± 0.3	57.2 ± 0.4
Day 23	52.8 ± 0.4	52.6 ± 0.4	53.2 ± 0.4	53.3 ± 0.4	53.5 ± 0.4	53.1 ± 0.5
Week 14	49.9 ± 0.3	50.0 ± 0.3	49.8 ± 0.3	50.2 ± 0.2	50.1 ± 0.3	50.1 ± 0.4
Mean cell hemoglobin (pg)						
Day 3	18.6 ± 0.1	18.7 ± 0.1	18.7 ± 0.1	18.7 ± 0.2	18.7 ± 0.1	18.7 ± 0.1
Day 23	18.5 ± 0.1	18.4 ± 0.1	18.7 ± 0.1	18.6 ± 0.2	18.5 ± 0.1	18.5 ± 0.1
Week 14	16.8 ± 0.0	16.9 ± 0.1	16.8 ± 0.0	16.8 ± 0.0	16.8 ± 0.0	16.8 ± 0.1
Mean cell hemoglobin concentration (g/dL)						
Day 3	33.4 ± 0.2	33.6 ± 0.1	33.4 ± 0.2	32.9 ± 0.2	33.3 ± 0.2	32.7 ± 0.1**
Day 23	35.1 ± 0.2	34.9 ± 0.2	35.1 ± 0.1	34.8 ± 0.1	34.5 ± 0.2	34.8 ± 0.2
Week 14	33.7 ± 0.2	33.7 ± 0.2	33.7 ± 0.3	33.5 ± 0.1	33.5 ± 0.1	33.6 ± 0.3
Platelets (10 ³ /μL)						
Day 3	922.4 ± 25.1	878.9 ± 26.9	874.8 ± 43.1	815.7 ± 14.4*	836.6 ± 33.9	851.0 ± 14.6
Day 23	680.2 ± 19.2	672.0 ± 13.6	669.8 ± 14.2	646.3 ± 24.1	681.5 ± 17.9	642.8 ± 30.8
Week 14	515.5 ± 10.4	530.9 ± 12.0	535.1 ± 7.3	501.6 ± 7.4	525.9 ± 5.3	541.2 ± 7.9
Leukocytes (10 ³ /μL)						
Day 3	7.85 ± 0.39	8.76 ± 0.36	8.71 ± 0.31	8.55 ± 0.32	7.84 ± 0.48	7.86 ± 0.34
Day 23	5.56 ± 0.55	6.12 ± 0.18	5.85 ± 0.35	6.08 ± 0.45	5.87 ± 0.45	6.61 ± 0.35
Week 14	5.73 ± 0.39	6.14 ± 0.27	6.13 ± 0.36	6.73 ± 0.30	6.04 ± 0.36	5.69 ± 0.37
Segmented neutrophils (10 ³ /μL)						
Day 3	0.80 ± 0.09	0.74 ± 0.11	0.91 ± 0.12	0.77 ± 0.10	0.74 ± 0.10	0.92 ± 0.08
Day 23	0.82 ± 0.14	0.90 ± 0.09	0.78 ± 0.07	0.83 ± 0.07	0.73 ± 0.07	0.84 ± 0.10
Week 14	0.93 ± 0.08	1.17 ± 0.10	1.33 ± 0.12	0.95 ± 0.12	1.07 ± 0.10	1.02 ± 0.11
Lymphocytes (10 ³ /μL)						
Day 3	6.81 ± 0.34	7.88 ± 0.35	7.74 ± 0.26	7.72 ± 0.24	6.87 ± 0.44	6.81 ± 0.31
Day 23	4.68 ± 0.48	5.20 ± 0.13	5.03 ± 0.37	5.21 ± 0.42	5.11 ± 0.42	5.73 ± 0.38
Week 14	4.70 ± 0.35	4.86 ± 0.24	4.70 ± 0.30	5.71 ± 0.25	4.93 ± 0.34	4.59 ± 0.32

TABLE F1
Hematology and Clinical Chemistry Data for Rats in the 14-Week Inhalation Study of Isobutene

	Chamber Control	500 ppm	1,000 ppm	2,000 ppm	4,000 ppm	8,000 ppm
Male (continued)						
Hematology (continued)						
n	10	10	10	10	10	10
Monocytes ($10^3/\mu\text{L}$)						
Day 3	0.20 ± 0.05	0.12 ± 0.04	0.06 ± 0.03	0.02 ± 0.01**	0.15 ± 0.04	0.12 ± 0.03
Day 23	0.04 ± 0.02	0.01 ± 0.01	0.02 ± 0.02	0.03 ± 0.03	0.01 ± 0.01	0.01 ± 0.01
Week 14	0.06 ± 0.02	0.05 ± 0.02	0.06 ± 0.02	0.04 ± 0.02	0.03 ± 0.01	0.05 ± 0.02
Eosinophils ($10^3/\mu\text{L}$)						
Day 3	0.03 ± 0.02	0.02 ± 0.02	0.01 ± 0.01	0.03 ± 0.02	0.07 ± 0.02	0.02 ± 0.01
Day 23	0.03 ± 0.01	0.01 ± 0.01	0.02 ± 0.01	0.00 ± 0.00	0.02 ± 0.01	0.03 ± 0.01
Week 14	0.05 ± 0.02	0.06 ± 0.02	0.04 ± 0.02	0.03 ± 0.02	0.01 ± 0.01	0.03 ± 0.02
Clinical Chemistry						
n						
Day 3	10	10	10	10	9	10
Day 23	10	10	10	10	10	10
Week 14	10	10	10	10	10	10
Urea nitrogen (mg/dL)						
Day 3	12.7 ± 0.7	14.2 ± 0.6	12.3 ± 0.4	11.1 ± 0.5	11.9 ± 0.6	11.5 ± 0.5
Day 23	15.6 ± 0.4	14.7 ± 0.3	14.6 ± 0.3	15.2 ± 0.5	14.9 ± 0.2	14.6 ± 0.2
Week 14	20.6 ± 0.7	19.7 ± 0.6	18.8 ± 0.7	20.4 ± 0.7	19.6 ± 0.8	19.2 ± 0.6
Creatinine (mg/dL)						
Day 3	0.61 ± 0.05	0.62 ± 0.02	0.56 ± 0.03	0.47 ± 0.02**	0.53 ± 0.04*	0.51 ± 0.02*
Day 23	0.73 ± 0.02	0.72 ± 0.01	0.71 ± 0.02	0.70 ± 0.02	0.72 ± 0.01	0.71 ± 0.02
Week 14	0.86 ± 0.02	0.88 ± 0.02	0.89 ± 0.01	0.86 ± 0.02	0.86 ± 0.02	0.84 ± 0.02
Serum glucose (mg/dL)						
Day 3	146 ± 4	158 ± 2	162 ± 4	162 ± 4*	147 ± 3	138 ± 2
Day 23	157 ± 4	156 ± 10	157 ± 4	150 ± 3	153 ± 2	155 ± 5
Week 14	153 ± 7	185 ± 12	158 ± 5	171 ± 11	178 ± 13	166 ± 10
Total protein (g/dL)						
Day 3	6.2 ± 0.1	6.5 ± 0.1	6.2 ± 0.1	6.0 ± 0.1	6.0 ± 0.1	6.1 ± 0.1
Day 23	6.8 ± 0.1	6.6 ± 0.1	6.7 ± 0.1	6.8 ± 0.1	6.7 ± 0.1	6.6 ± 0.1
Week 14	7.6 ± 0.1	7.6 ± 0.1	7.7 ± 0.1	7.5 ± 0.1	7.7 ± 0.1	7.5 ± 0.1
Albumin (g/dL)						
Day 3	5.0 ± 0.1	5.3 ± 0.1	5.1 ± 0.1	4.8 ± 0.1	4.9 ± 0.1	5.0 ± 0.1
Day 23	4.9 ± 0.1	4.9 ± 0.1	4.9 ± 0.1	5.0 ± 0.1	4.9 ± 0.1	4.9 ± 0.1
Week 14	4.8 ± 0.1	4.9 ± 0.1	4.9 ± 0.1	4.8 ± 0.1	4.8 ± 0.1	4.8 ± 0.1
Globulin (g/dL)						
Day 3	1.1 ± 0.1	1.2 ± 0.1	1.1 ± 0.0	1.1 ± 0.1	1.2 ± 0.1	1.1 ± 0.0
Day 23	1.9 ± 0.1	1.7 ± 0.1	1.8 ± 0.1	1.8 ± 0.1	1.8 ± 0.1	1.7 ± 0.1
Week 14	2.8 ± 0.1	2.7 ± 0.1	2.9 ± 0.1	2.7 ± 0.1	2.9 ± 0.0	2.7 ± 0.1
A/G ratio						
Day 3	4.5 ± 0.3	4.6 ± 0.3	4.9 ± 0.3	4.4 ± 0.2	4.4 ± 0.3	4.4 ± 0.2
Day 23	2.7 ± 0.2	2.9 ± 0.2	2.9 ± 0.2	2.8 ± 0.1	2.8 ± 0.2	3.0 ± 0.2
Week 14	1.7 ± 0.1	1.8 ± 0.0	1.7 ± 0.1	1.8 ± 0.1	1.7 ± 0.0	1.8 ± 0.1

TABLE F1
Hematology and Clinical Chemistry Data for Rats in the 14-Week Inhalation Study of Isobutene

	Chamber Control	500 ppm	1,000 ppm	2,000 ppm	4,000 ppm	8,000 ppm
Female (continued)						
n	10	10	10	10	10	10
Hematology (continued)						
Nucleated erythrocytes ($10^3/\mu\text{L}$)						
Day 3	0.05 ± 0.02	0.05 ± 0.02	0.06 ± 0.02	0.06 ± 0.03	0.04 ± 0.02	0.07 ± 0.04
Day 23	0.03 ± 0.01	0.02 ± 0.02	0.01 ± 0.01	0.02 ± 0.01	0.02 ± 0.01	0.00 ± 0.00
Week 14	0.03 ± 0.01	0.01 ± 0.01	0.02 ± 0.01	0.04 ± 0.01	0.01 ± 0.01	0.01 ± 0.01
Mean cell volume (fL)						
Day 3	55.3 ± 0.4	56.5 ± 0.4	55.3 ± 0.7	57.1 ± 0.3*	56.4 ± 0.3	56.3 ± 0.6
Day 23	56.0 ± 0.4	55.6 ± 0.5	55.7 ± 0.4	55.9 ± 0.4	55.3 ± 0.3	56.4 ± 0.3
Week 14	53.4 ± 0.3	53.6 ± 0.2	53.2 ± 0.3	53.2 ± 0.2	53.3 ± 0.2	53.6 ± 0.2
Mean cell hemoglobin (pg)						
Day 3	18.9 ± 0.1	19.0 ± 0.1	18.8 ± 0.1	18.8 ± 0.1	18.7 ± 0.1	18.8 ± 0.1
Day 23	18.9 ± 0.1	19.0 ± 0.1	18.9 ± 0.1	18.9 ± 0.1	18.8 ± 0.1	19.0 ± 0.1
Week 14	18.2 ± 0.1	18.2 ± 0.1	18.1 ± 0.1	18.1 ± 0.0	18.2 ± 0.1	18.3 ± 0.1
Mean cell hemoglobin concentration (g/dL)						
Day 3	34.1 ± 0.2	33.7 ± 0.3	34.1 ± 0.4	32.9 ± 0.2*	33.3 ± 0.1	33.5 ± 0.3
Day 23	34.0 ± 0.3	34.1 ± 0.2	33.9 ± 0.3	33.8 ± 0.2	34.0 ± 0.1	33.5 ± 0.2
Week 14	34.1 ± 0.2	34.1 ± 0.1	34.1 ± 0.1	34.1 ± 0.2	34.2 ± 0.1	34.0 ± 0.2
Platelets ($10^3/\mu\text{L}$)						
Day 3	797.5 ± 48.0	861.6 ± 63.7	831.0 ± 40.1	871.7 ± 39.4	840.8 ± 54.6	791.4 ± 32.1
Day 23	705.0 ± 21.4	675.0 ± 30.5	754.5 ± 35.2	721.4 ± 20.5	707.4 ± 11.4	745.5 ± 19.9
Week 14	599.4 ± 16.2	615.8 ± 26.6	570.2 ± 24.2	530.5 ± 13.4*	575.8 ± 15.1	603.8 ± 19.2
Leukocytes ($10^3/\mu\text{L}$)						
Day 3	8.24 ± 0.39	8.61 ± 0.25	8.45 ± 0.38	8.90 ± 0.28	9.94 ± 0.54*	9.34 ± 0.43*
Day 23	5.44 ± 0.36	6.26 ± 0.57	5.68 ± 0.34	5.76 ± 0.31	5.97 ± 0.60	5.74 ± 0.43
Week 14	6.71 ± 0.14	6.95 ± 0.27	6.92 ± 0.45	6.95 ± 0.20	7.26 ± 0.39	6.43 ± 0.40
Segmented neutrophils ($10^3/\mu\text{L}$)						
Day 3	0.78 ± 0.10	0.77 ± 0.10	0.79 ± 0.10	0.78 ± 0.08	1.16 ± 0.13	0.97 ± 0.19
Day 23	0.72 ± 0.08	0.76 ± 0.12	0.76 ± 0.08	0.76 ± 0.09	0.99 ± 0.12	0.81 ± 0.09
Week 14	1.03 ± 0.10	0.86 ± 0.08	1.22 ± 0.15	0.95 ± 0.08	1.40 ± 0.12	1.05 ± 0.14
Lymphocytes ($10^3/\mu\text{L}$)						
Day 3	7.33 ± 0.39	7.70 ± 0.20	7.54 ± 0.37	7.99 ± 0.28	8.71 ± 0.46	8.28 ± 0.36
Day 23	4.65 ± 0.33	5.42 ± 0.49	4.81 ± 0.31	4.95 ± 0.33	4.90 ± 0.52	4.87 ± 0.49
Week 14	5.59 ± 0.17	6.02 ± 0.27	5.62 ± 0.32	5.90 ± 0.20	5.76 ± 0.35	5.29 ± 0.31
Monocytes ($10^3/\mu\text{L}$)						
Day 3	0.09 ± 0.04	0.11 ± 0.04	0.09 ± 0.03	0.07 ± 0.04	0.03 ± 0.02	0.04 ± 0.03
Day 23	0.02 ± 0.01	0.02 ± 0.01	0.02 ± 0.01	0.01 ± 0.01	0.00 ± 0.00	0.01 ± 0.01
Week 14	0.04 ± 0.02	0.03 ± 0.02	0.04 ± 0.02	0.05 ± 0.02	0.05 ± 0.02	0.03 ± 0.01
Eosinophils ($10^3/\mu\text{L}$)						
Day 3	0.04 ± 0.02	0.03 ± 0.01	0.04 ± 0.02	0.05 ± 0.02	0.05 ± 0.02	0.05 ± 0.02
Day 23	0.05 ± 0.02	0.06 ± 0.02	0.07 ± 0.02	0.03 ± 0.01	0.07 ± 0.02	0.03 ± 0.01
Week 14	0.05 ± 0.02	0.04 ± 0.01	0.04 ± 0.02	0.06 ± 0.02	0.05 ± 0.02	0.08 ± 0.02
Clinical Chemistry						
Urea nitrogen (mg/dL)						
Day 3	18.3 ± 1.1	13.4 ± 0.5**	14.6 ± 0.7**	14.1 ± 0.3**	13.5 ± 0.5**	12.9 ± 0.5**
Day 23	14.3 ± 0.4	14.6 ± 0.6	14.0 ± 0.5	13.5 ± 0.6	13.7 ± 0.4	13.1 ± 0.3
Week 14	19.4 ± 1.0	20.0 ± 0.7	20.0 ± 0.8	19.2 ± 1.1	19.7 ± 0.5	19.0 ± 0.8
Creatinine (mg/dL)						
Day 3	0.63 ± 0.02	0.63 ± 0.02	0.59 ± 0.02	0.55 ± 0.02**	0.59 ± 0.02*	0.58 ± 0.03*
Day 23	0.76 ± 0.02	0.84 ± 0.02	0.77 ± 0.03	0.76 ± 0.02	0.77 ± 0.02	0.75 ± 0.02
Week 14	0.83 ± 0.03	0.81 ± 0.03	0.85 ± 0.02	0.84 ± 0.02	0.83 ± 0.03	0.80 ± 0.02

TABLE F1
Hematology and Clinical Chemistry Data for Rats in the 14-Week Inhalation Study of Isobutene

	Chamber Control	500 ppm	1,000 ppm	2,000 ppm	4,000 ppm	8,000 ppm
Female (continued)						
n	10	10	10	10	10	10
Clinical Chemistry (continued)						
Serum glucose (mg/dL)						
Day 3	124 ± 4	136 ± 6	141 ± 9	128 ± 3	127 ± 4	122 ± 4
Day 23	155 ± 4	171 ± 13	166 ± 8	148 ± 6	158 ± 3	164 ± 5
Week 14	164 ± 5	169 ± 11	176 ± 10	170 ± 7	167 ± 4	169 ± 5
Total protein (g/dL)						
Day 3	6.1 ± 0.1	6.1 ± 0.1	6.0 ± 0.1	6.0 ± 0.1	6.0 ± 0.1	6.1 ± 0.1
Day 23	6.5 ± 0.1	6.6 ± 0.1	6.5 ± 0.1	6.4 ± 0.1	6.5 ± 0.1	6.6 ± 0.1
Week 14	7.3 ± 0.1	7.5 ± 0.1	7.6 ± 0.1	7.3 ± 0.1	7.3 ± 0.1	7.3 ± 0.1
Albumin (g/dL)						
Day 3	5.4 ± 0.1	5.7 ± 0.1	5.5 ± 0.1	5.5 ± 0.0	5.4 ± 0.1	5.3 ± 0.1
Day 23	4.7 ± 0.1	4.8 ± 0.1	4.8 ± 0.1	4.7 ± 0.0	4.8 ± 0.1	4.7 ± 0.1
Week 14	5.1 ± 0.1	5.2 ± 0.1	5.1 ± 0.1	5.1 ± 0.1	5.0 ± 0.1	5.0 ± 0.1
Globulin (g/dL)						
Day 3	0.7 ± 0.1	0.5 ± 0.1	0.5 ± 0.1	0.5 ± 0.0*	0.6 ± 0.1	0.8 ± 0.1
Day 23	1.8 ± 0.1	1.8 ± 0.1	1.8 ± 0.1	1.7 ± 0.1	1.7 ± 0.0	1.8 ± 0.1
Week 14	2.2 ± 0.1	2.3 ± 0.1	2.5 ± 0.1	2.3 ± 0.1	2.4 ± 0.1	2.3 ± 0.1
A/G ratio						
Day 3	8.1 ± 0.8	14.5 ± 2.7 ^b	12.8 ± 2.0	13.1 ± 1.1	9.9 ± 1.3	7.5 ± 1.0
Day 23	2.7 ± 0.1	2.6 ± 0.1	2.7 ± 0.1	2.9 ± 0.1	2.8 ± 0.1	2.6 ± 0.1
Week 14	2.4 ± 0.1	2.3 ± 0.1	2.1 ± 0.1	2.3 ± 0.1	2.1 ± 0.1	2.3 ± 0.1
Alanine aminotransferase (IU/L)						
Day 3	34 ± 1	34 ± 1	35 ± 2	34 ± 1	33 ± 1	33 ± 1
Day 23	30 ± 1	34 ± 3	30 ± 1	29 ± 1	29 ± 1	30 ± 1
Week 14	47 ± 2	65 ± 6*	55 ± 3	66 ± 7*	54 ± 5	60 ± 4
Alkaline phosphatase (IU/L)						
Day 3	583 ± 22	577 ± 21	569 ± 32	539 ± 20	486 ± 18*	554 ± 26
Day 23	347 ± 10	391 ± 10*	366 ± 12	366 ± 9	330 ± 10	347 ± 8
Week 14	307 ± 15	328 ± 11	369 ± 14*	317 ± 15	321 ± 12	306 ± 13
Creatine kinase (IU/L)						
Day 3	204 ± 16	222 ± 12	210 ± 24	198 ± 18	205 ± 26	277 ± 36
Day 23	197 ± 35	196 ± 24	162 ± 20	202 ± 27	183 ± 28	221 ± 59
Week 14	109 ± 9	122 ± 20	112 ± 12	139 ± 17	134 ± 14	146 ± 13
Sorbitol dehydrogenase (IU/L)						
Day 3	16 ± 0	16 ± 1	14 ± 1*	14 ± 0**	15 ± 1*	14 ± 1*
Day 23	15 ± 1	19 ± 2	14 ± 1	16 ± 1	15 ± 1	16 ± 0
Week 14	14 ± 1	17 ± 1	17 ± 1	17 ± 1	15 ± 2	17 ± 1
Bile acids (µmol/L)						
Day 3	17.9 ± 1.9	13.6 ± 1.3	20.0 ± 3.7	17.8 ± 1.3	16.1 ± 1.2	16.1 ± 1.2
Day 23	14.6 ± 0.7	21.7 ± 5.7	18.0 ± 2.0	14.7 ± 1.1	14.2 ± 0.6	16.6 ± 1.4
Week 14	24.8 ± 3.5	24.5 ± 3.4	30.5 ± 6.1	40.1 ± 5.6	32.6 ± 5.4	30.4 ± 4.2

* Significantly different ($P \leq 0.05$) from the chamber control group by Dunn's or Shirley's test

** $P \leq 0.01$

^a Mean ± standard error. Statistical tests were performed on unrounded data.

^b n=9

^c n=8

APPENDIX G

ORGAN WEIGHTS AND ORGAN-WEIGHT-TO-BODY-WEIGHT RATIOS

TABLE G1	Organ Weights and Organ-Weight-to-Body-Weight Ratios for Rats in the 14-Week Inhalation Study of Isobutene	200
TABLE G2	Organ Weights and Organ-Weight-to-Body-Weight Ratios for Mice in the 14-Week Inhalation Study of Isobutene	201

TABLE G1
Organ Weights and Organ-Weight-to-Body-Weight Ratios for Rats in the 14-Week Inhalation Study of Isobutene^a

	Chamber Control	500 ppm	1,000 ppm	2,000 ppm	4,000 ppm	8,000 ppm
n	10	10	10	10	10	10
Male						
Necropsy body wt	359 ± 8	367 ± 6	365 ± 8	364 ± 6	362 ± 7	366 ± 6
Heart						
Absolute	0.993 ± 0.022	1.040 ± 0.021	1.090 ± 0.026*	1.031 ± 0.017	1.033 ± 0.015	1.050 ± 0.025
Relative	2.77 ± 0.05	2.83 ± 0.02	2.99 ± 0.06*	2.84 ± 0.05	2.86 ± 0.06	2.87 ± 0.06
R. Kidney						
Absolute	1.116 ± 0.019	1.191 ± 0.028	1.187 ± 0.030	1.182 ± 0.021	1.219 ± 0.030**	1.231 ± 0.024**
Relative	3.12 ± 0.04	3.24 ± 0.04*	3.25 ± 0.03*	3.25 ± 0.06*	3.36 ± 0.05**	3.36 ± 0.04**
Liver						
Absolute	12.073 ± 0.484	12.419 ± 0.279	12.377 ± 0.301	12.348 ± 0.291	12.438 ± 0.323	12.461 ± 0.364
Relative	33.58 ± 0.66	33.81 ± 0.53	33.93 ± 0.29	33.91 ± 0.45	34.31 ± 0.43	33.98 ± 0.59
Lung						
Absolute	1.649 ± 0.074	1.625 ± 0.040	1.728 ± 0.039	1.677 ± 0.055	1.666 ± 0.036	1.785 ± 0.057
Relative	4.60 ± 0.17	4.43 ± 0.10	4.75 ± 0.14	4.62 ± 0.17	4.61 ± 0.10	4.89 ± 0.20
R. Testis						
Absolute	1.416 ± 0.031	1.412 ± 0.026	1.417 ± 0.025	1.412 ± 0.011	1.419 ± 0.016	1.445 ± 0.011
Relative	3.96 ± 0.07	3.84 ± 0.03	3.89 ± 0.06	3.89 ± 0.07	3.93 ± 0.06	3.95 ± 0.06
Thymus						
Absolute	0.324 ± 0.015	0.314 ± 0.017	0.319 ± 0.010	0.332 ± 0.014	0.296 ± 0.021	0.309 ± 0.014
Relative	0.91 ± 0.05	0.86 ± 0.05	0.88 ± 0.03	0.91 ± 0.04	0.82 ± 0.06	0.84 ± 0.04
Female						
Necropsy body wt	207 ± 4	202 ± 2	215 ± 5	213 ± 5	208 ± 4	217 ± 6
Heart						
Absolute	0.669 ± 0.014	0.655 ± 0.010	0.710 ± 0.017	0.689 ± 0.016	0.680 ± 0.010	0.719 ± 0.015
Relative	3.23 ± 0.05	3.24 ± 0.04	3.30 ± 0.06	3.23 ± 0.04	3.27 ± 0.06	3.32 ± 0.05
R. Kidney						
Absolute	0.682 ± 0.023	0.669 ± 0.012	0.746 ± 0.017	0.696 ± 0.018	0.645 ± 0.045	0.725 ± 0.017
Relative	3.29 ± 0.10	3.31 ± 0.07	3.47 ± 0.05	3.27 ± 0.06	3.09 ± 0.21	3.35 ± 0.04
Liver						
Absolute	6.101 ± 0.129	6.450 ± 0.133	7.267 ± 0.193**	6.875 ± 0.257**	6.673 ± 0.211**	7.006 ± 0.248**
Relative	29.45 ± 0.51	31.92 ± 0.65*	33.75 ± 0.64**	32.20 ± 0.73*	32.01 ± 0.65*	32.27 ± 0.53*
Lung						
Absolute	1.116 ± 0.034	1.014 ± 0.030	1.162 ± 0.069	1.182 ± 0.058	1.173 ± 0.057	1.222 ± 0.045
Relative	5.38 ± 0.13	5.01 ± 0.11	5.38 ± 0.25	5.55 ± 0.25	5.64 ± 0.27	5.67 ± 0.28
Thymus						
Absolute	0.235 ± 0.012	0.245 ± 0.007	0.250 ± 0.014	0.236 ± 0.011	0.243 ± 0.015	0.246 ± 0.009
Relative	1.14 ± 0.06	1.21 ± 0.03	1.16 ± 0.05	1.10 ± 0.03	1.16 ± 0.06	1.14 ± 0.03

* Significantly different ($P \leq 0.05$) from the chamber control group by Williams' or Dunnett's test

** $P \leq 0.01$

^a Organ weights (absolute weights) and body weights are given in grams; organ-weight-to-body-weight ratios (relative weights) are given as mg organ weight/g body weight (mean ± standard error).

TABLE G2
Organ Weights and Organ-Weight-to-Body-Weight Ratios for Mice in the 14-Week Inhalation Study of Isobutene^a

	Chamber Control	500 ppm	1,000 ppm	2,000 ppm	4,000 ppm	8,000 ppm
n	10	10	10	10	10	10
Male						
Necropsy body wt	37.8 ± 1.4	38.2 ± 0.8	39.8 ± 0.8	38.0 ± 0.9	37.5 ± 0.6	37.8 ± 1.1
Heart						
Absolute	0.164 ± 0.005	0.169 ± 0.004	0.164 ± 0.005	0.165 ± 0.005	0.166 ± 0.005	0.160 ± 0.004
Relative	4.38 ± 0.16	4.43 ± 0.09	4.15 ± 0.17	4.35 ± 0.08	4.41 ± 0.09	4.25 ± 0.10
R. Kidney						
Absolute	0.309 ± 0.012	0.340 ± 0.008	0.345 ± 0.010*	0.339 ± 0.007	0.336 ± 0.007	0.345 ± 0.008*
Relative	8.26 ± 0.38	8.91 ± 0.16	8.70 ± 0.27	8.97 ± 0.24	8.95 ± 0.12	9.15 ± 0.17*
Liver						
Absolute	1.747 ± 0.076	1.800 ± 0.034	1.819 ± 0.043	1.794 ± 0.046	1.764 ± 0.034	1.815 ± 0.054
Relative	46.21 ± 0.72	47.23 ± 0.96	45.80 ± 0.81	47.29 ± 0.61	47.00 ± 0.58	48.04 ± 0.67
Lung						
Absolute	0.228 ± 0.007	0.228 ± 0.016	0.232 ± 0.007	0.239 ± 0.004	0.244 ± 0.006	0.238 ± 0.004
Relative	6.09 ± 0.21	5.97 ± 0.38	5.85 ± 0.19	6.33 ± 0.17	6.51 ± 0.15	6.34 ± 0.19
R. Testis						
Absolute	0.121 ± 0.002	0.125 ± 0.002	0.123 ± 0.003	0.124 ± 0.002	0.127 ± 0.003	0.109 ± 0.010
Relative	3.25 ± 0.12	3.27 ± 0.04	3.11 ± 0.11	3.28 ± 0.08	3.38 ± 0.06	2.91 ± 0.27
Thymus						
Absolute	0.037 ± 0.003	0.037 ± 0.002	0.037 ± 0.003	0.040 ± 0.002	0.041 ± 0.002	0.036 ± 0.003
Relative	0.99 ± 0.09	0.97 ± 0.05	0.94 ± 0.08	1.04 ± 0.04	1.10 ± 0.04	0.95 ± 0.08
Female						
Necropsy body wt	33.8 ± 0.7	32.6 ± 0.9	35.6 ± 1.2	34.8 ± 0.9	33.8 ± 1.0	33.9 ± 0.8
Heart						
Absolute	0.134 ± 0.003	0.138 ± 0.002	0.142 ± 0.003	0.140 ± 0.003	0.135 ± 0.002	0.137 ± 0.003
Relative	3.98 ± 0.10	4.25 ± 0.10	4.02 ± 0.13	4.04 ± 0.09	4.02 ± 0.10	4.05 ± 0.10
R. Kidney						
Absolute	0.198 ± 0.004	0.226 ± 0.005**	0.226 ± 0.006**	0.222 ± 0.005**	0.226 ± 0.005**	0.234 ± 0.003**
Relative	5.89 ± 0.19	6.95 ± 0.19**	6.38 ± 0.12**	6.40 ± 0.13**	6.72 ± 0.16**	6.93 ± 0.13**
Liver						
Absolute	1.603 ± 0.036	1.622 ± 0.038	1.697 ± 0.050	1.694 ± 0.047	1.659 ± 0.050	1.665 ± 0.040
Relative	47.48 ± 0.59	49.80 ± 0.91	47.85 ± 0.76	48.72 ± 0.59	49.14 ± 0.89	49.11 ± 0.45
Lung						
Absolute	0.232 ± 0.007	0.233 ± 0.005	0.247 ± 0.007	0.248 ± 0.005	0.233 ± 0.007	0.236 ± 0.004
Relative	6.88 ± 0.20	7.17 ± 0.20	6.97 ± 0.14	7.15 ± 0.13	6.90 ± 0.11	6.99 ± 0.18
Thymus						
Absolute	0.054 ± 0.002	0.055 ± 0.003	0.062 ± 0.006	0.057 ± 0.002	0.054 ± 0.004	0.055 ± 0.003
Relative	1.60 ± 0.07	1.68 ± 0.08	1.71 ± 0.10	1.65 ± 0.07	1.60 ± 0.09	1.62 ± 0.06

* Significantly different ($P \leq 0.05$) from the chamber control group by Williams' or Dunnett's test

** $P \leq 0.01$

^a Organ weights (absolute weights) and body weights are given in grams; organ-weight-to-body-weight ratios (relative weights) are given as mg organ weight/g body weight (mean ± standard error).

APPENDIX H

REPRODUCTIVE TISSUE EVALUATIONS AND ESTROUS CYCLE CHARACTERIZATION

TABLE H1	Summary of Reproductive Tissue Evaluations for Male Rats in the 14-Week Inhalation Study of Isobutene	204
TABLE H2	Summary of Estrous Cycle Characterization for Female Rats in the 14-Week Inhalation Study of Isobutene	204
TABLE H3	Summary of Reproductive Tissue Evaluations for Male Mice in the 14-Week Inhalation Study of Isobutene	205
TABLE H4	Summary of Estrous Cycle Characterization for Female Mice in the 14-Week Inhalation Study of Isobutene	205

TABLE H1
Summary of Reproductive Tissue Evaluations for Male Rats in the 14-Week Inhalation Study of Isobutene^a

	Chamber Control	2,000 ppm	4,000 ppm	8,000 ppm
n	10	10	10	10
Weights (g)				
Necropsy body wt	358 ± 8	364 ± 6	362 ± 7	366 ± 6
L. cauda epididymis	0.1742 ± 0.0063	0.1906 ± 0.0020	0.1838 ± 0.0065	0.1936 ± 0.0046*
L. epididymis	0.4650 ± 0.0067	0.4758 ± 0.0040	0.4601 ± 0.0107	0.4780 ± 0.0067
L. testis	1.4802 ± 0.0260	1.4905 ± 0.0079	1.4913 ± 0.0304	1.5185 ± 0.0211
Spermatid measurements				
Spermatid heads (10 ⁷ /g testis)	9.89 ± 0.34	10.11 ± 0.40	9.95 ± 0.28	9.97 ± 0.22
Spermatid heads (10 ⁷ /testis)	14.63 ± 0.54	15.07 ± 0.62	14.82 ± 0.44	15.15 ± 0.43
Spermatid count (mean/10 ⁻⁴ mL suspension)	73.13 ± 2.68	75.35 ± 3.09	74.08 ± 2.18	75.75 ± 2.13
Epididymal spermatozoal measurements				
Motility (%)	91.15 ± 3.18	89.32 ± 2.01	88.04 ± 1.97	86.53 ± 1.90*
Concentration (10 ⁶ /g cauda epididymal tissue)	886 ± 55	836 ± 39	819 ± 66	840 ± 39

* Significantly different ($P \leq 0.05$) from the chamber control group by Shirley's test (motility) or by Dunnett's test (left caudal weights)

^a Data are presented as mean ± standard error. Differences from the chamber control group are not significant by Dunnett's test (body weights) or Dunn's test (spermatid measurements and epididymal spermatozoal measurements).

TABLE H2
Summary of Estrous Cycle Characterization for Female Rats in the 14-Week Inhalation Study of Isobutene^a

	Chamber Control	2,000 ppm	4,000 ppm	8,000 ppm
n	10	10	10	10
Necropsy body wt (g)	207 ± 4	213 ± 5	208 ± 4	217 ± 6
Estrous cycle length (days)	4.70 ± 0.15	4.80 ± 0.13	4.80 ± 0.11	4.80 ± 0.08
Estrous stages (% of cycle)				
Diestrus	40.0	38.3	38.3	39.2
Proestrus	17.5	18.3	18.3	13.3
Estrus	20.8	20.8	25.0	24.2
Metestrus	20.8	20.8	18.3	21.7
Uncertain diagnoses	0.8	1.7	0.0	1.7

^a Necropsy body weight and estrous cycle length data are presented as mean ± standard error. Differences from the chamber control group are not significant by Dunnett's test (body weights) or Dunn's test (estrous cycle length). By multivariate analysis of variance, exposed females do not differ significantly from the chamber control females in the relative length of time spent in the estrous stages.

TABLE H3
Summary of Reproductive Tissue Evaluations for Male Mice in the 14-Week Inhalation Study of Isobutene^a

	Chamber Control	2,000 ppm	4,000 ppm	8,000 ppm
n	10	10	10	10
Weights (g)				
Necropsy body wt	37.8 ± 1.4	38.0 ± 0.9	37.5 ± 0.6	37.8 ± 1.1
L. cauda epididymis	0.0167 ± 0.0011	0.0187 ± 0.0014	0.0196 ± 0.0007	0.0173 ± 0.0009
L. epididymis	0.0436 ± 0.0016	0.0485 ± 0.0015	0.0462 ± 0.0017	0.0426 ± 0.0022
L. testis	0.1165 ± 0.0020	0.1191 ± 0.0010	0.1201 ± 0.0018	0.1038 ± 0.0093
Spermatid measurements				
Spermatid heads (10 ⁷ /g testis)	18.17 ± 0.54	17.49 ± 0.53	18.21 ± 0.90	15.32 ± 1.80
Spermatid heads (10 ⁷ /testis)	2.12 ± 0.08	2.09 ± 0.07	2.18 ± 0.10	1.73 ± 0.20
Spermatid count (mean/10 ⁻⁴ mL suspension)	66.20 ± 2.39	65.15 ± 2.30	68.23 ± 3.22	53.95 ± 6.29
Epididymal spermatozoal measurements				
Motility (%)	79.31 ± 2.74	77.65 ± 1.94	76.94 ± 1.53	76.07 ± 1.38 ^b
Concentration (10 ⁶ /g cauda epididymal tissue)	1,261 ± 142 ^b	1,534 ± 151	1,225 ± 88 ^b	1,444 ± 228

^a Data are presented as mean ± standard error. Differences from the chamber control group are not significant by Dunnett's test (body and tissue weights) or Dunn's test (spermatid and epididymal spermatozoal measurements).

^b n= 9

TABLE H4
Summary of Estrous Cycle Characterization for Female Mice in the 14-Week Inhalation Study of Isobutene^a

	Chamber Control	2,000 ppm	4,000 ppm	8,000 ppm
n	10	10	10	10
Necropsy body wt (g)	33.8 ± 0.7	34.8 ± 0.9	33.8 ± 1.0	33.9 ± 0.8
Estrous cycle length (days)	4.50 ± 0.15	4.11 ± 0.07 ^b	4.56 ± 0.13 ^b	4.20 ± 0.11
Estrous stages ^c (% of cycle)				
Diestrus	27.5	34.2	39.2	33.3
Proestrus	16.7	21.7	19.2	20.0
Estrus	37.5	25.8	24.2	29.2
Metestrus	17.5	18.3	17.5	15.0
Uncertain diagnoses	0.8	0.0	0.0	2.5

^a Necropsy body weight and estrous cycle length data are presented as mean ± standard error. Differences from the chamber control group are not significant by Dunnett's test (body weights) or Dunn's test (estrous cycle length).

^b Estrous cycle was longer than 12 days or unclear in 1 of 10 animals.

^c Evidence shows that females exposed to 2,000 or 4,000 ppm differ significantly (Wilk's Criterion, P<0.05) from the chamber control females in the relative length of time spent in the estrous stages. Exposed females spent more time in diestrus and less time in estrus than chamber control females.

APPENDIX I
2-HYDROXYISOBUTYRIC ACID —
BIOMARKER OF EXPOSURE

TABLE I1	Urinary Biomarker Data for Rats in the 2-Year Inhalation Study of Isobutene	208
TABLE I2	Urinary Biomarker Data for Mice in the 2-Year Inhalation Study of Isobutene	209

TABLE II
Urinary Biomarker Data for Rats in the 2-Year Inhalation Study of Isobutene

	Chamber Control	500 ppm	2,000 ppm	8,000 ppm	Trend P Value ^a
n	5	10	10	10	
Male					
Urine excretion (g)					
6 Months	11.04 ± 1.67 ^b	9.08 ± 0.46	9.46 ± 0.94	8.80 ± 0.70	NS ^c
12 Months	6.83 ± 0.91	7.39 ± 0.69	7.61 ± 0.95	6.93 ± 0.44	NS
18 Months	8.96 ± 0.69	9.85 ± 1.11	12.11 ± 1.17	9.56 ± 0.73	NS
Urine creatinine (µg/g urine)					
6 Months	934.0 ± 90.3	1,073.0 ± 54.5	1,083.0 ± 79.5	1,131.0 ± 79.7	NS
12 Months	1,114.0 ± 95.7	1,240.0 ± 100.1	1,164.0 ± 83.2	1,279.0 ± 61.4	NS
18 Months	1,044.0 ± 84.5	989.0 ± 83.5	869.0 ± 60.9	1,011.0 ± 44.2	NS
Urine HIBA/urine (mg/total sample)					
6 Months	— ^d	5.040 ± 0.128	12.859 ± 0.273**	19.920 ± 0.379**	P ≤ 0.01
12 Months	—	5.353 ± 0.203	15.857 ± 0.643**	24.746 ± 1.352**	P ≤ 0.01
18 Months	—	4.059 ± 0.243	12.551 ± 1.650**	23.693 ± 1.132**	P ≤ 0.01
Urine HIBA/creatinine (µg/µg)					
6 Months	—	0.530 ± 0.010	1.348 ± 0.035**	2.103 ± 0.057**	P ≤ 0.01
12 Months	—	0.630 ± 0.020	1.959 ± 0.114**	2.843 ± 0.070**	P ≤ 0.01
18 Months	—	0.457 ± 0.018	1.211 ± 0.079**	2.526 ± 0.065**	P ≤ 0.01
Urine HIBA/creatinine/isobutene (ng/µg/ppm)					
6 Months	—	1.060 ± 0.020	0.674 ± 0.017**	0.263 ± 0.007**	P ≤ 0.01
12 Months	—	1.260 ± 0.041	0.979 ± 0.057**	0.355 ± 0.009**	P ≤ 0.01
18 Months	—	0.914 ± 0.035	0.606 ± 0.040**	0.316 ± 0.008**	P ≤ 0.01
Female					
Urine excretion (g)					
6 Months	6.70 ± 1.06	8.13 ± 1.37	9.65 ± 1.47	6.26 ± 0.71	NS
12 Months	6.30 ± 0.61	9.99 ± 3.67	9.71 ± 3.76	5.95 ± 0.86	NS
18 Months	6.44 ± 0.24	7.06 ± 0.73	9.82 ± 3.33	7.72 ± 0.64	NS
Urine creatinine (µg/g urine)					
6 Months	652.0 ± 62.2	733.0 ± 121.5	593.0 ± 88.6	693.0 ± 64.6	NS
12 Months	754.0 ± 65.2	787.0 ± 112.1	752.0 ± 91.1	846.0 ± 74.7	NS
18 Months	708.0 ± 30.1	652.0 ± 51.7	707.0 ± 83.2	731.0 ± 60.7	NS
Urine HIBA/urine (mg/total sample)					
6 Months	—	3.317 ± 0.146	6.203 ± 0.248**	8.657 ± 0.788**	P ≤ 0.01
12 Months	—	3.328 ± 0.265	8.541 ± 0.495**	13.356 ± 0.920**	P ≤ 0.01
18 Months	—	2.684 ± 0.340	8.431 ± 0.780**	15.450 ± 0.747**	P ≤ 0.01
Urine HIBA/creatinine (µg/µg)					
6 Months	—	0.731 ± 0.025	1.347 ± 0.075**	2.064 ± 0.060**	P ≤ 0.01
12 Months	—	0.672 ± 0.041	1.831 ± 0.123**	2.916 ± 0.122**	P ≤ 0.01
18 Months	—	0.564 ± 0.066	1.825 ± 0.122**	2.932 ± 0.222**	P ≤ 0.01
Urine HIBA/creatinine/isobutene (ng/µg/ppm)					
6 Months	—	1.462 ± 0.050	0.674 ± 0.037**	0.258 ± 0.008**	P ≤ 0.01
12 Months	—	1.344 ± 0.082	0.916 ± 0.061**	0.365 ± 0.015**	P ≤ 0.01
18 Months	—	1.128 ± 0.131	0.913 ± 0.061**	0.367 ± 0.028**	P ≤ 0.01

** Significantly different (P ≤ 0.01) from the 500 ppm group by Dunnett's test

^a The trend was assessed by linear regression analysis.

^b Mean ± standard error. HIBA = 2-hydroxyisobutyric acid

^c Not significant

^d Sample measurement less than limit of quantitation

TABLE I2
Urinary Biomarker Data for Mice in the 2-Year Inhalation Study of Isobutene

	Chamber Control	500 ppm	2,000 ppm	8,000 ppm	Trend P Value ^a
Male					
n					
6 Months	5	10	10	9	
12 Months	5	9	7	8	
18 Months	5	10	9	10	
Urine excretion (g)					
6 Months	1.34 ± 0.18 ^b	1.31 ± 0.23	1.15 ± 0.18	1.71 ± 0.33	NS ^c
12 Months	1.64 ± 0.26	2.05 ± 0.10	3.62 ± 1.22	1.80 ± 0.22	NS
18 Months	1.49 ± 0.37	1.84 ± 0.22	1.97 ± 0.32	1.84 ± 0.25	NS
Urine creatinine (µg/g urine)					
6 Months	314.0 ± 34.9	302.0 ± 17.0	337.5 ± 19.6 ^d	282.2 ± 18.4	NS
12 Months	244.0 ± 21.8	270.0 ± 25.4	220.0 ± 35.8	220.0 ± 29.5	NS
18 Months	230.0 ± 40.4	252.0 ± 11.1	242.2 ± 26.2	214.0 ± 21.9	NS
Urine HIBA/urine (mg/total sample)					
6 Months	— ^e	1.075 ± 0.174	3.224 ± 0.654*	6.169 ± 1.265**	P ≤ 0.01
12 Months	—	2.046 ± 0.079	7.336 ± 0.334**	10.971 ± 1.757**	P ≤ 0.01
18 Months	—	1.629 ± 0.134	6.079 ± 0.903**	11.277 ± 1.497**	P ≤ 0.01
Urine HIBA/creatinine (µg/µg)					
6 Months	—	2.832 ± 0.222	8.665 ± 1.565** ^d	13.298 ± 1.640**	P ≤ 0.01
12 Months	—	3.971 ± 0.343	14.226 ± 1.689**	26.269 ± 2.839**	P ≤ 0.01
18 Months	—	4.159 ± 0.749	11.882 ± 0.833**	25.888 ± 2.127**	P ≤ 0.01
Urine HIBA/creatinine/isobutene (ng/µg/ppm)					
6 Months	—	5.664 ± 0.444	4.333 ± 0.782 ^d	1.662 ± 0.205**	P ≤ 0.01
12 Months	—	7.942 ± 0.687	7.113 ± 0.844	3.284 ± 0.355**	P ≤ 0.01
18 Months	—	8.318 ± 1.498	5.941 ± 0.416	3.236 ± 0.266**	P ≤ 0.01
Female					
n					
6 Months	5	10	9	10	
12 Months	5	10	10	10	
18 Months	5	10	10	10	
Urine excretion (g)					
6 Months	1.47 ± 0.14	1.17 ± 0.12	1.39 ± 0.13	1.14 ± 0.17	NS
12 Months	1.66 ± 0.17	1.62 ± 0.11	2.96 ± 1.21	1.44 ± 0.08	NS
18 Months	1.60 ± 0.13	1.70 ± 0.15	1.81 ± 0.23	1.55 ± 0.10	NS
Urine creatinine (µg/g urine)					
6 Months	294.0 ± 18.6	331.0 ± 33.4	331.1 ± 30.2	352.2 ± 28.7 ^f	NS
12 Months	278.0 ± 22.0	217.0 ± 9.3	235.0 ± 23.2	274.0 ± 11.1	NS
18 Months	264.0 ± 16.3	208.0 ± 15.5	246.0 ± 20.9	241.0 ± 10.6	NS
Urine HIBA/urine (mg/total sample)					
6 Months	—	1.370 ± 0.130	5.441 ± 0.446**	5.843 ± 0.841**	P ≤ 0.05
12 Months	—	1.640 ± 0.078	5.894 ± 0.475**	8.294 ± 0.779**	P ≤ 0.01
18 Months	—	1.668 ± 0.137	6.349 ± 0.292**	8.524 ± 0.743**	P ≤ 0.01
Urine HIBA/creatinine (µg/µg)					
6 Months	—	4.017 ± 0.529	12.341 ± 0.653**	15.977 ± 1.361** ^f	P ≤ 0.01
12 Months	—	4.830 ± 0.266	12.989 ± 1.389**	21.375 ± 2.187**	P ≤ 0.01
18 Months	—	4.983 ± 0.345	15.898 ± 1.205**	22.758 ± 1.859**	P ≤ 0.01

TABLE I2
Urinary Biomarker Data for Mice in the 2-Year Inhalation Study of Isobutene

	Chamber Control	500 ppm	2,000 ppm	8,000 ppm	Trend P Value
Female (continued)					
n					
6 Months	5	10	9	10	
12 Months	5	10	10	10	
18 Months	5	10	10	10	
Urine HIBA/creatinine/isobutene (ng/ μ g/ppm)					
6 Months	—	8.034 \pm 1.057	6.171 \pm 0.326 ^d	1.997 \pm 0.170 ^{**f}	P \leq 0.01
12 Months	—	9.660 \pm 0.532	6.495 \pm 0.695 ^{**}	2.672 \pm 0.273 ^{**}	P \leq 0.01
18 Months	—	9.966 \pm 0.691	7.949 \pm 0.603	2.845 \pm 0.232 ^{**}	P \leq 0.01

* Significantly different (P \leq 0.05) from the 500 ppm group by Dunnett's test

** P \leq 0.01

^a The trend was assessed by linear regression analysis.

^b Mean \pm standard error. HIBA= 2-hydroxyisobutyric acid

^c Not significant

^d n= 8

^e Sample measurement less than limit of quantitation

^f n= 9

APPENDIX J

CHEMICAL CHARACTERIZATION AND GENERATION OF CHAMBER CONCENTRATIONS

PROCUREMENT AND CHARACTERIZATION OF ISOBUTENE	212
VAPOR GENERATION AND EXPOSURE SYSTEM	213
VAPOR CONCENTRATION MONITORING	214
CHAMBER ATMOSPHERE CHARACTERIZATION	214
FIGURE J1 Infrared Absorption Spectrum of Isobutene	216
FIGURE J2 Nuclear Magnetic Resonance Spectrum of Isobutene	217
FIGURE J3 Schematic of Generation and Delivery System	218
FIGURE J4 14-Week Inhalation Suite	219
FIGURE J5 2-Year Inhalation Suite	220
TABLE J1 Summary of Chamber Concentrations in the 14-Week Inhalation Studies of Isobutene . . .	221
TABLE J2 Summary of Chamber Concentrations in the 2-Year Inhalation Studies of Isobutene	221

CHEMICAL CHARACTERIZATION AND GENERATION OF CHAMBER CONCENTRATIONS

PROCUREMENT AND CHARACTERIZATION OF ISOBUTENE

Isobutene was manufactured by Exxon, Inc. (Baytown, TX), supplied by Specialty Gas Concepts (La Porte, TX) and shipped through Norco (Kennewick, WA) in two lots (SGC051091ECA and SGC020594ECA). Lot SGC051091ECA was used during the 14-week and 2-year studies, and lot SGC020594ECA was used during the 2-year studies. Identity, purity, and stability analyses were conducted by the study laboratory, Battelle Pacific Northwest Laboratories (Richland, WA). Reports on analyses performed in support of the isobutene studies are on file at the National Institute of Environmental Health Sciences.

The chemical, a colorless vapor at room temperature, was identified as isobutene by infrared and nuclear magnetic resonance spectroscopy. The infrared spectrum was consistent with a literature spectrum (Aldrich, 1985) of isobutene. Both spectra were consistent with those expected for the structure of isobutene and with those of a reference standard supplied by Matheson Gas Products (East Rutherford, NJ) at a stated purity of 99.9%. The infrared and nuclear magnetic spectra are presented in Figures J1 and J2.

The initial purity of each lot was determined with gas chromatography/flame ionization detection (GC/FID). Two systems were used for initial purity determinations on each lot:

- A) $\text{Al}_2\text{O}_3/\text{KCl}$ PLOT column (10 M \times 0.53 mm), with an oven temperature program of 45° C for 5 minutes, then 45° to 180° C at 20° C per minute and held for 1 minute, using a nitrogen carrier gas at a flow rate of 30 mL/minute,
- B) DB-624 fused silica column (30 M \times 0.53 mm) with a 3 μm film thickness, with an oven temperature program of -15° C for 10 minutes, then -15° to 100° C at 20° C per minute and held for 1 minute, and a nitrogen carrier gas at a flow rate of 5 to 15 mL/minute, and
- C) $\text{Al}_2\text{O}_3/\text{Na}_2\text{SO}_4$ PLOT column (50 M \times 0.53 mm), with an oven temperature program of 130° C for 5 minutes to 190° C (no hold time) at 10° C/minute using nitrogen as a carrier gas at a flow rate of 30 mL/minute.

Major peak comparisons with GC/FID indicated a relative purity of 100.0% by system A and 100.6% by system B for lot SGC051091ECA relative to the reference standard. For lot SGC020594ECA, gas chromatographic peak comparison indicated a relative purity of 98.7% by system C and 98.5% by system A. The overall purity of lot SGC051091ECA was determined to be greater than 99%, and the overall purity of lot SGC020594ECA was greater than 98%.

Additional analyses of each lot were performed with gas chromatography/mass spectrometry (GC/MS) to identify and quantify the impurities indicated by the manufacturer or by GC/FID. The gas chromatograph system included a flame ionization detector, an RT_X volatile fused silica column (60 M \times 0.32 mm with 1.5 μm film thickness) with a nitrogen carrier gas at a flow rate of 1.7 mL per minute and an oven temperature program of -15° C for 12 minutes, then -15° to 150° C at 15° C per minute and held for 3 minutes. The mass spectrum pattern of the major peak was consistent with isobutene. The following impurities were detected for lot SGC051091ECA (concentrations were estimated): propane/propene, 42 ppm; isobutane, 140 ppm; 1,3-butadiene, 6 ppm; *trans*-2-butene, 213 ppm; and *cis*-2-butene, 286 ppm. Butane and *n*-butene coeluted with the major peak and were not quantified. Lot SGC020594ECA contained an estimated 11 ppm propane/propene, 339 ppm isobutane, 15 ppm *trans*-2-butene, 11 ppm *cis*-2-butene, and no 1,3-butadiene. Samples from each cylinder of each lot of isobutene were analyzed for 1,3-butadiene

before the cylinder was used for exposure by GC/MS with the same system but with an isothermal oven temperature of -15°C . All cylinders used in the 14-week studies contained less than 50 ppm 1,3-butadiene, well within the maximum limit of 100 ppm; the maximum concentration detected in cylinders used in the 2-year studies was 15 ppm. Cylinders used in the 14-week studies were also screened individually for other impurities; results indicated less than 1% impurities by peak area.

In a 4-day pilot study, the stability of isobutene was monitored in grab-bag samples taken from the distribution manifold at the beginning and the end of 6-hour generation periods until approximately 94% of the cylinder was exhausted. Isobutene in the distribution manifold was assumed to be of equivalent purity to that in the cylinder headspace because no dilution flow was present. Samples were analyzed using GC/FID with a column as in system B (14-week studies) or a column as in system C (2-year studies) and using modified temperature programs. The results from samples taken over 8 test generation days showed no significant enhancement of any volatile impurities, and no additional impurities were detected with relative areas of 0.1% or greater relative to isobutene. Based on these results, approximately 90% of the contents of each cylinder were used during the 14-week and 2-year studies.

During the studies, the bulk chemical was stored in its original shipping cylinders at approximately 22°C . Stability was monitored throughout the studies by the study laboratory with GC/FID by system A. No degradation of the bulk chemical was detected.

VAPOR GENERATION AND EXPOSURE SYSTEM

Diagrams of the isobutene generation and delivery system used in the 14-week and 2-year studies are shown in Figure J3. Because isobutene is a vapor at room temperature, it was distributed under regulated pressure, and the chemical flow rate to each chamber was monitored and adjusted individually. Isobutene was delivered directly from the cylinder. Two cylinders of isobutene were connected in parallel to the exposure system; one supplied isobutene for exposures while the other cylinder was available if the first did not maintain sufficient gas pressure in the distribution manifold. Warm circulating-water blankets surrounding the cylinders provided additional heat to replace the heat lost due to isobutene vaporization. The manifold pressure was regulated to approximately 7 psi with a two-stage regulator on the cylinder. The gas passed through a filter via a main on/off pneumatic valve, operated either manually or by computer, and then was distributed by a manifold to five (14-week studies) or six (2-year studies) pairs of metering valves with corresponding flow meters. Isobutene was delivered to each exposure chamber through these flow meters via three-way solenoid valves located at the chamber end of the vapor delivery line. Each three-way valve was controlled either manually or by computer; when the valve to a chamber was closed, the vapor was routed to the exposure system exhaust.

Isobutene vapor was diluted with conditioned air as it was injected into the chamber inlet duct. The concentration in each chamber was controlled by manually adjusting the individual chamber metering valves. The generation system was purged with nitrogen at the end of the exposure day.

Stainless-steel chambers (Hazleton H-2000®) manufactured by Lab Products, Inc. (Harford Systems Division, Aberdeen, MD) were used throughout the studies. The total volume of each chamber was 2.3 m^3 ; the active mixing volume of each chamber was 1.7 m^3 . The chamber was designed by the study laboratory so that uniform vapor concentrations could be maintained through the chamber when catch pans were in place. Diagrams of the inhalation suites are shown in Figures J4 and J5.

VAPOR CONCENTRATION MONITORING

Chamber concentrations of isobutene were monitored during both studies by an on-line GC/FID with a column as in system A and a modified temperature program. Samples were drawn from each chamber, the

exposure room, and the on-line standard approximately every 20 minutes during exposures by a computer-controlled, 12-port stream select valve.

The on-line GC/FID was calibrated by direct analysis of volumetrically prepared gas-bag standards during the 14-week studies and against validated, commercially prepared, certified standards for the 2-year studies. Calibrations were performed approximately once a month or if drift occurred in the value of the on-line standard. An on-line standard of isobutene in nitrogen was used to monitor instrument drift before the start of each exposure day and once during each monitoring cycle. Standard exposure and chamber samples were taken in triplicate. A Teflon® line was coupled directly to the calibration port of the on-line monitor stream select valve.

Summaries of the chamber concentrations for the 14-week and 2-year studies are presented in Tables J1 and J2.

CHAMBER ATMOSPHERE CHARACTERIZATION

The times for the exposure concentration to build up to 90% of the final exposure concentration (T_{90}) and to decay to 10% of the exposure concentration (T_{10}) were measured. In all studies, T_{90} and T_{10} were measured in all exposure chambers with and without animals present. At a chamber air flow rate of 15 air changes per hour, the theoretical value for both T_{90} and T_{10} was calculated to be 12.5 minutes. The actual chamber air flow rates were maintained at 12 to 18 changes per hour during all studies.

In the 14-week studies, without animals present, T_{90} values and T_{10} values ranged from 8 to 9 minutes for rats and mice. With animals present, T_{90} values ranged from 9 to 10 minutes for rats and mice; T_{10} values ranged from 9 to 11 minutes for rats and mice. In the 2-year studies, without animals present, T_{90} values ranged from 11 to 15 minutes for rats and from 9 to 13 minutes for mice; T_{10} values ranged from 8 to 10 minutes for rats and from 6 to 9 minutes for mice. With animals present, T_{90} values ranged from 9 to 12 minutes for rats and from 8 to 11 minutes for mice; T_{10} values ranged from 9 to 12 minutes for rats and from 10 to 11 minutes for mice. The T_{90} value selected for all studies was 12 minutes.

Vapor concentration uniformity in the exposure chambers without animals present was measured before each of the studies began. Concentration uniformity with animals present was measured during the first week of the 14-week rat study and at approximately 90-day intervals during the 2-year studies. Vapor concentration was measured using the on-line GC/FID with the automatic 12-port sample valve disabled to allow continuous monitoring from a single input line. Samples were taken from several positions in each chamber without animals and from two positions with animals present. Chamber concentration uniformity was maintained throughout the studies.

During the 14-week and 2-year studies, the persistence of isobutene after exposure ceased was monitored by GC/FID in the 8,000 ppm chambers with animals present. Persistence in the chambers with no animals present was tested before the 14-week and 2-year studies began. Without animals present, the concentration fell to less than 1% of the target concentration within 19 minutes for the 14-week studies and 2-year rat study; for the 2-year mouse study, the concentration fell to less than 1% of the target concentration within 16 minutes. In the 14-week studies with animals present, the concentration decreased to less than 1% within 22 minutes. In the 2-year studies with animals present, the concentration decreased to less than 1% of the target concentration within 24 minutes (rat chamber) or 25 minutes (mouse chamber).

Before and during the 14-week and 2-year studies, the stability of isobutene in the 500 and 8,000 ppm chambers was analyzed with the on-line GC/FID within the first and last hours of the exposure day. Additionally, samples from the 500 and 8,000 ppm chambers were collected with a syringe and transferred to a gas sample bag; these samples and samples collected directly from the distribution manifold were

analyzed by an off-line GC/FID with a DB-624 column (14-week studies) or GC/FID with an Al₂O₃/Na₂SO₄ PLOT column (2-year studies) within the first and last hours of the exposure day. Mixed standard gas bags containing equivalent concentrations of each of the expected volatile contaminants (propene, propane, isobutane, 1-butene, 1,3-butadiene, *n*-butane, *trans*-2-butene, and *cis*-2-butene) were volumetrically prepared in addition to an isobutene reference standard gas bag. During the 14-week study analyses, butene was the only contaminant completely unresolved from isobutene on both GC/FIDs. One unidentified impurity with a concentration of 0.14% relative to the concentration of isobutene was detected by the off-line GC/FID at the beginning of the exposure period in the 8,000 ppm chamber before the 14-week studies began; this impurity was not detected at the end of the exposure period. An unidentified impurity was also detected in the 500 ppm chamber with a relative concentration of 0.12% at the beginning of exposure and 0.04% at the end of the exposure period. No other impurities were detected with relative areas of 0.1% or greater during the 14-week studies, although several volatile impurities were present in the 500 and 8,000 ppm chambers and the distribution manifold at concentrations of less than 0.1% relative to the isobutene concentrations. No impurities with concentrations of 0.1% or greater relative to the isobutene concentration were detected by the on-line or off-line GC/FID before the 2-year studies began. During the 2-year studies, the on-line GC/FID detected an unidentified impurity at the beginning of the exposure period in the 500 ppm rat and mouse chambers at relative concentrations of 0.6% and 0.7%, respectively, and at the end of the exposure period in the 500 ppm mouse chamber with a relative concentration of less than 1%. No other impurities with concentrations of 0.1% or greater relative to the isobutene concentrations were identified during the 2-year studies by either GC/FID.

Relative concentrations of 1,3-butadiene remained well below 100 ppm. The results from these stability studies indicated that isobutene was stable under the conditions used to generate and transport it to the exposure chambers and that no significant enhancement of impurities was detected in the distribution manifold or the exposure chambers over the course of a typical exposure day.

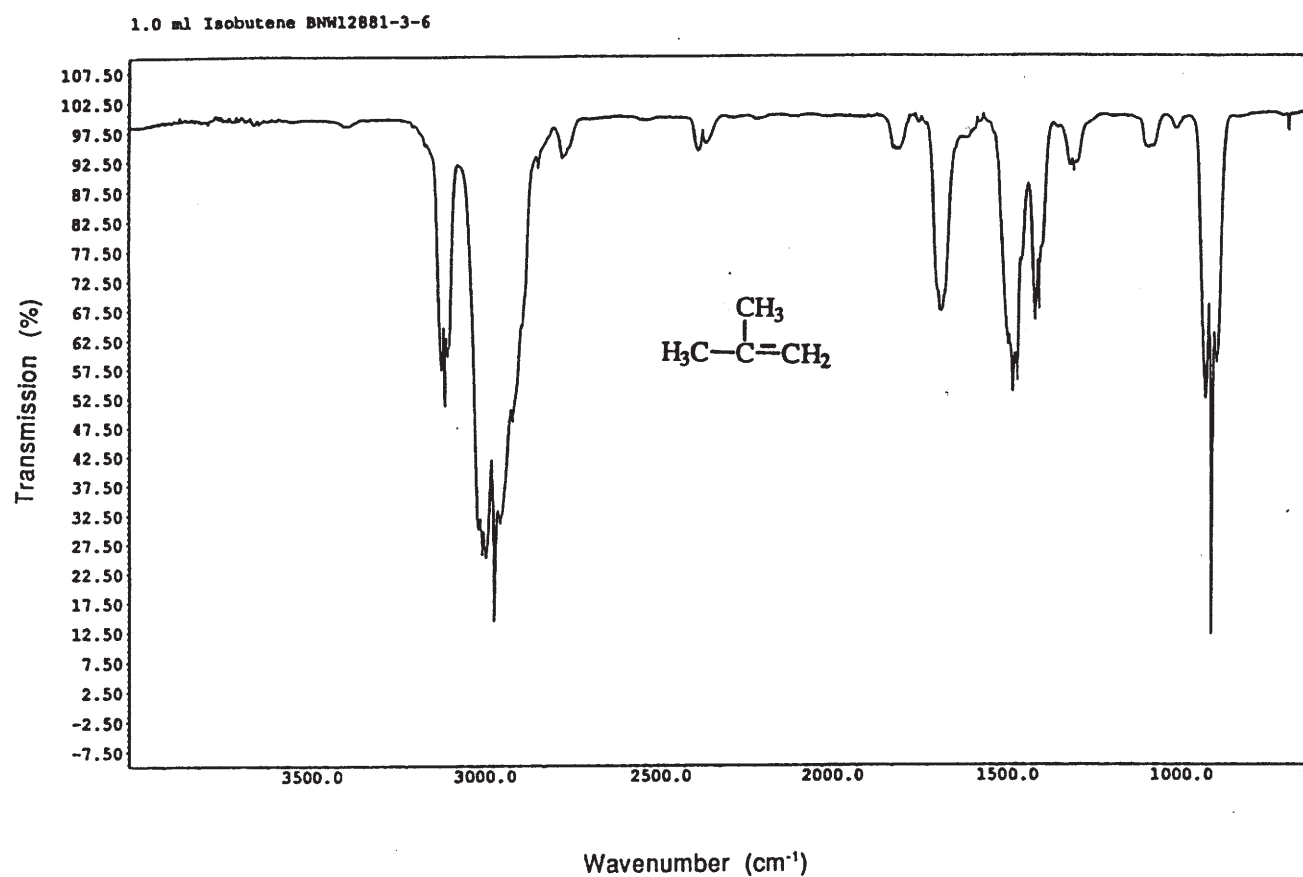

FIGURE J1
Infrared Absorption Spectrum of Isobutene

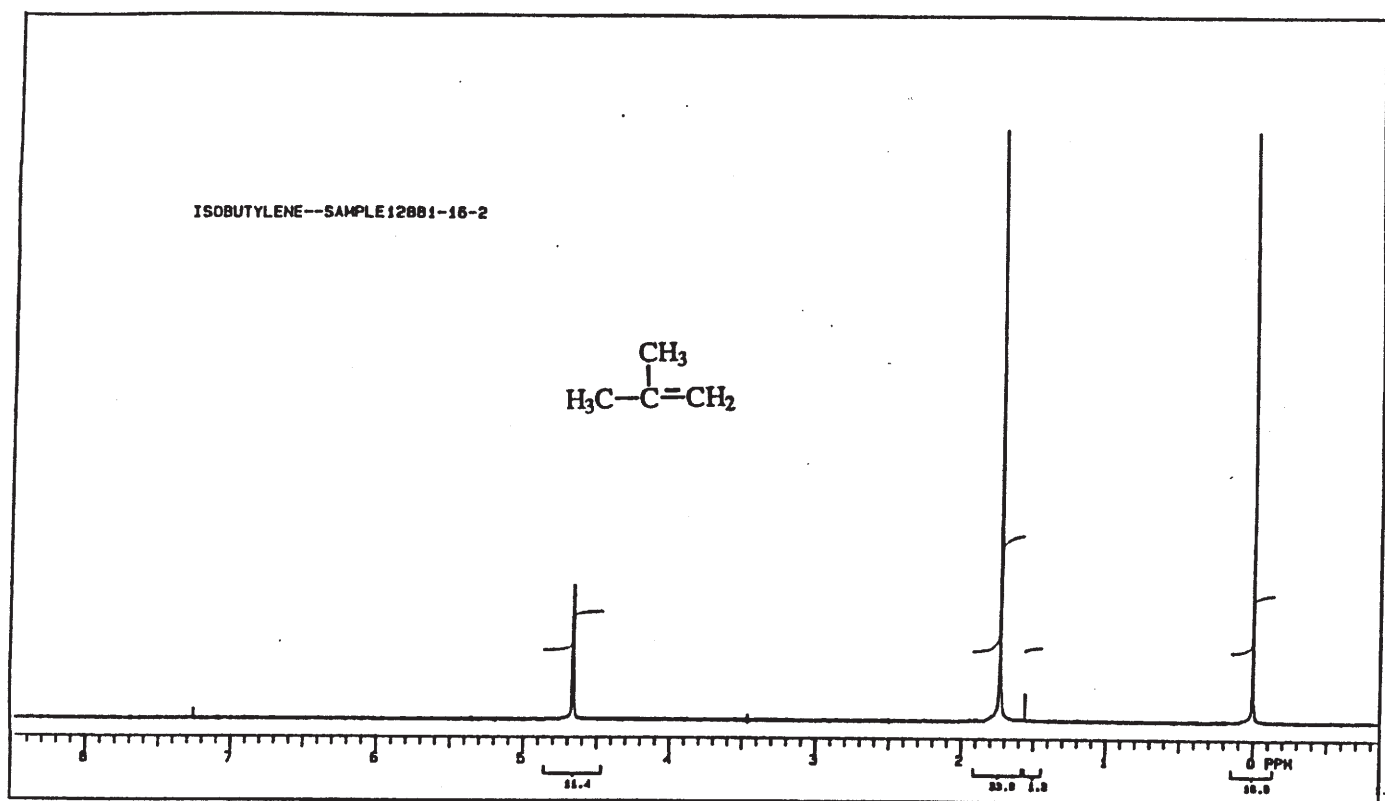

FIGURE J2
Nuclear Magnetic Resonance Spectrum of Isobutene

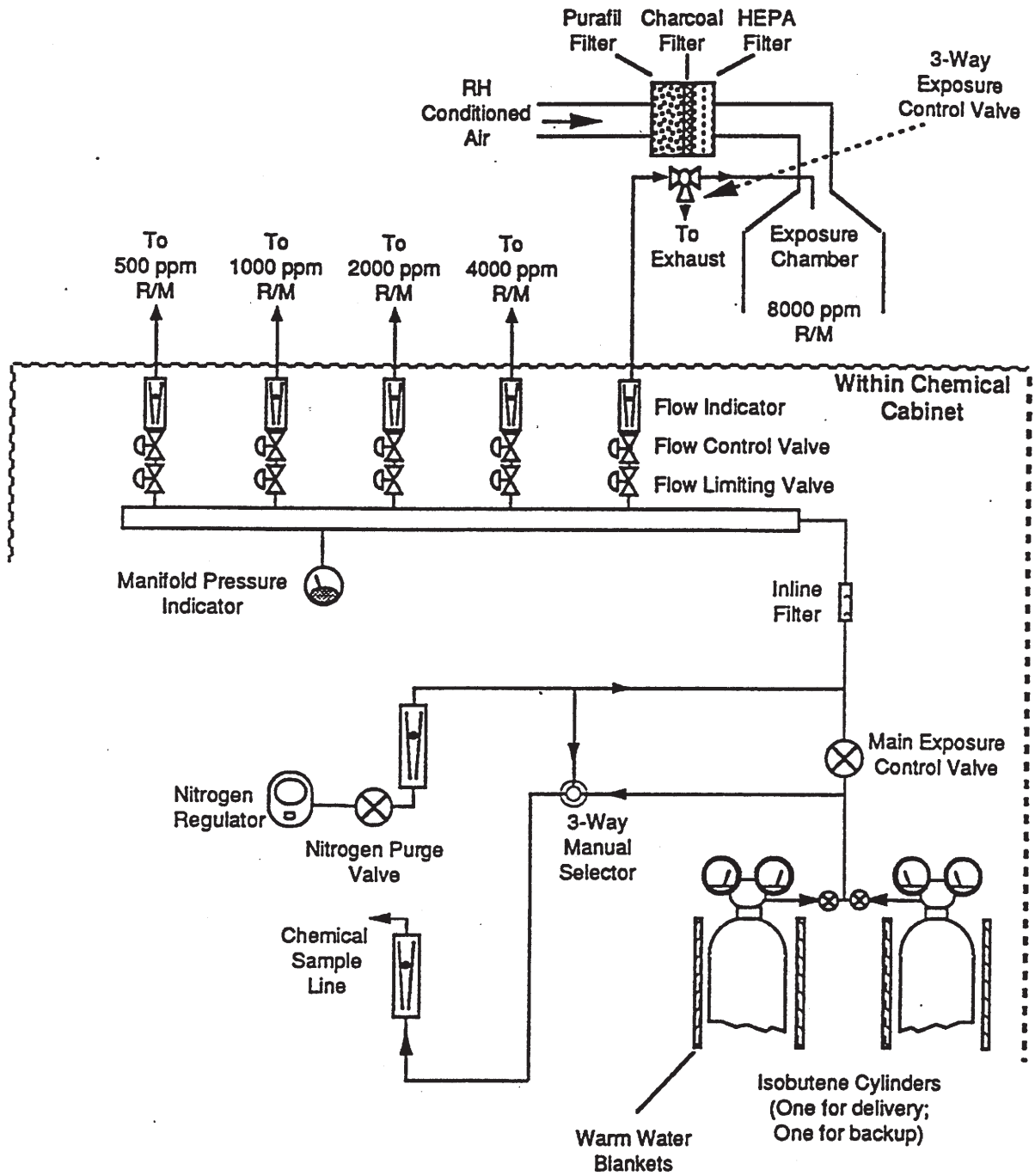

FIGURE J3
Schematic of Generation and Delivery System

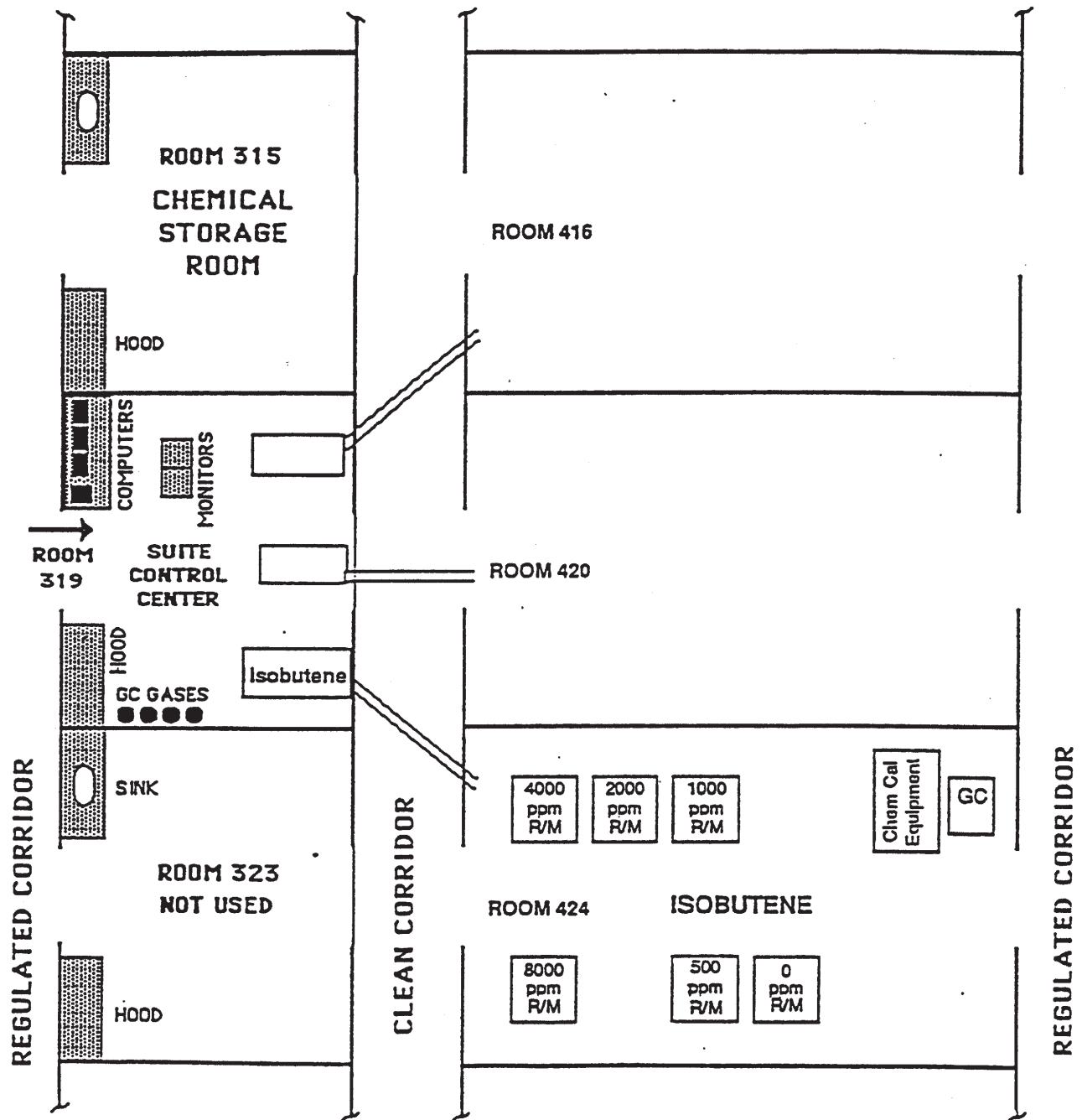

FIGURE J4
14-Week Inhalation Suite

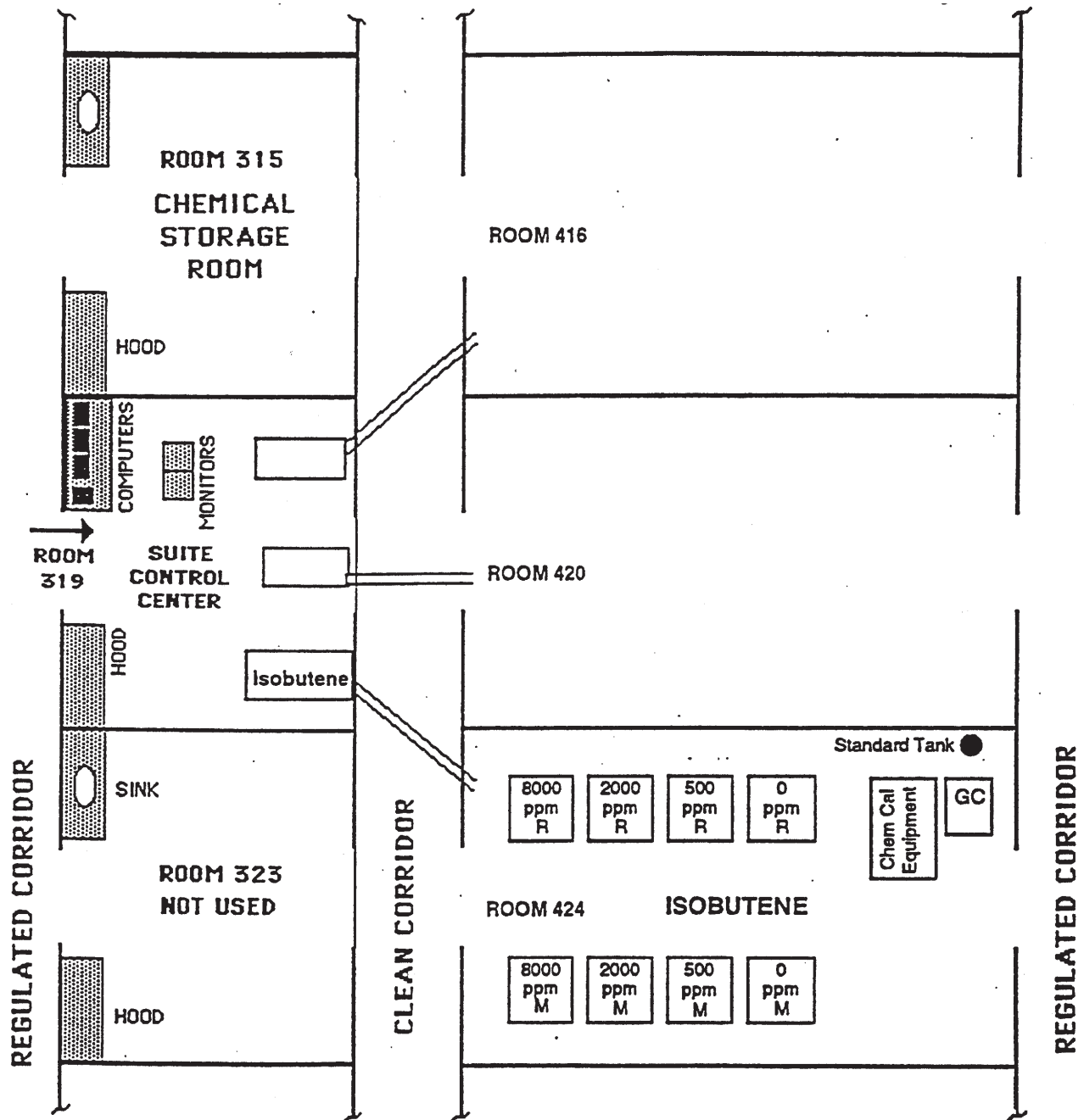

FIGURE J5
2 Year Inhalation Suite

TABLE J1
Summary of Chamber Concentrations in the 14-Week Inhalation Studies of Isobutene

Target Concentration (ppm)	Total Number of Readings	Average Concentration ^a (ppm)
Rat Chambers		
500	1,176	495 ± 16
1,000	1,183	1,010 ± 35
2,000	1,185	1,990 ± 61
4,000	1,185	4,010 ± 130
8,000	1,184	7,970 ± 585
Mouse Chambers		
500	1,193	495 ± 16
1,000	1,201	1,010 ± 35
2,000	1,203	1,990 ± 62
4,000	1,203	4,010 ± 130
8,000	1,202	7,980 ± 582

^a Mean ± standard deviation

TABLE J2
Summary of Chamber Concentrations in the 2-Year Inhalation Studies of Isobutene

Target Concentration (ppm)	Total Number of Readings	Average Concentration ^a (ppm)
Rat Chambers		
500	7,467	497 ± 21
2,000	7,521	1,990 ± 72
8,000	7,550	7,940 ± 313
Mouse Chambers		
500	7,476	498 ± 20
2,000	7,430	1,990 ± 74
8,000	7,536	7,960 ± 283

^a Mean ± standard deviation

APPENDIX K
INGREDIENTS, NUTRIENT COMPOSITION,
AND CONTAMINANT LEVELS
IN NIH-07 RAT AND MOUSE RATION

TABLE K1	Ingredients of NIH-07 Rat and Mouse Ration	224
TABLE K2	Vitamins and Minerals in NIH-07 Rat and Mouse Ration	224
TABLE K3	Nutrient Composition of NIH-07 Rat and Mouse Ration	225
TABLE K4	Contaminant Levels in NIH-07 Rat and Mouse Ration	226

TABLE K1
Ingredients of NIH-07 Rat and Mouse Ration^a

Ingredients ^b	Percent by Weight
Ground #2 yellow shelled corn	24.50
Ground hard winter wheat	23.00
Soybean meal (49% protein)	12.00
Fish meal (60% protein)	10.00
Wheat middlings	10.00
Dried skim milk	5.00
Alfalfa meal (dehydrated, 17% protein)	4.00
Corn gluten meal (60% protein)	3.00
Soy oil	2.50
Dried brewer's yeast	2.00
Dry molasses	1.50
Dicalcium phosphate	1.25
Ground limestone	0.50
Salt	0.50
Premixes (vitamin and mineral)	0.25

^a NCI, 1976; NIH, 1978

^b Ingredients were ground to pass through a U.S. Standard Screen No. 16 before being mixed.

TABLE K2
Vitamins and Minerals in NIH-07 Rat and Mouse Ration^a

	Amount	Source
Vitamins		
A	5,500,000 IU	Stabilized vitamin A palmitate or acetate
D ₃	4,600,000 IU	D-activated animal sterol
K ₃	2.8 g	Menadione
<i>d</i> - α -Tocopheryl acetate	20,000 IU	
Choline	560.0 g	Choline chloride
Folic acid	2.2 g	
Niacin	30.0 g	
<i>d</i> -Pantothenic acid	18.0 g	<i>d</i> -Calcium pantothenate
Riboflavin	3.4 g	
Thiamine	10.0 g	Thiamine mononitrate
B ₁₂	4,000 μ g	
Pyridoxine	1.7 g	Pyridoxine hydrochloride
Biotin	140.0 mg	<i>d</i> -Biotin
Minerals		
Iron	120.0 g	Iron sulfate
Manganese	60.0 g	Manganous oxide
Zinc	16.0 g	Zinc oxide
Copper	4.0 g	Copper sulfate
Iodine	1.4 g	Calcium iodate
Cobalt	0.4 g	Cobalt carbonate

^a Per ton (2,000 lb) of finished product

TABLE K3
Nutrient Composition of NIH-07 Rat and Mouse Ration

Nutrient	Mean \pm Standard Deviation	Range	Number of Samples
Protein (% by weight)	22.91 \pm 0.48	22.1) 23.6	24
Crude fat (% by weight)	5.34 \pm 0.18	5.00) 5.80	24
Crude fiber (% by weight)	3.12 \pm 0.29	2.60) 4.00	24
Ash (% by weight)	6.23 \pm 0.16	5.72) 6.54	24
Amino Acids (% of total diet)			
Arginine	1.273 \pm 0.083	1.100) 1.390	12
Cystine	0.307 \pm 0.068	0.181) 0.400	12
Glycine	1.152 \pm 0.051	1.060) 1.220	12
Histidine	0.581 \pm 0.029	0.531) 0.630	12
Isoleucine	0.913 \pm 0.034	0.867) 0.965	12
Leucine	1.969 \pm 0.053	1.850) 2.040	12
Lysine	1.269 \pm 0.050	1.200) 1.370	12
Methionine	0.436 \pm 0.104	0.306) 0.699	12
Phenylalanine	0.999 \pm 0.114	0.665) 1.110	12
Threonine	0.899 \pm 0.059	0.824) 0.985	12
Tryptophan	0.216 \pm 0.146	0.107) 0.671	12
Tyrosine	0.690 \pm 0.091	0.564) 0.794	12
Valine	1.079 \pm 0.057	0.962) 1.170	12
Essential Fatty Acids (% of total diet)			
Linoleic	2.389 \pm 0.223	1.830) 2.570	11
Linolenic	0.273 \pm 0.034	0.210) 0.320	11
Vitamins			
Vitamin A (IU/kg)	6,802 \pm 546	5,550) 8,800	24
Vitamin D (IU/kg)	4,450 \pm 1,382	3,000) 6,300	4
α -Tocopherol (ppm)	35.24 \pm 8.58	22.5) 48.9	12
Thiamine (ppm)	16.87 \pm 3.66	13.0) 26.0	23
Riboflavin (ppm)	7.78 \pm 0.899	6.10) 9.00	12
Niacin (ppm)	98.73 \pm 23.21	65.0) 150.0	12
Pantothenic acid (ppm)	32.94 \pm 8.92	23.0) 59.2	12
Pyridoxine (ppm)	9.28 \pm 2.49	5.60) 14.0	12
Folic acid (ppm)	2.56 \pm 0.70	1.80) 3.70	12
Biotin (ppm)	0.265 \pm 0.046	0.190) 0.354	12
Vitamin B ₁₂ (ppb)	41.6 \pm 18.6	10.6) 65.0	12
Choline (ppm)	2,955 \pm 382	2,300) 3,430	11
Minerals			
Calcium (%)	1.15 \pm 0.06	1.03) 1.27	24
Phosphorus (%)	0.89 \pm 0.02	0.84) 0.95	24
Potassium (%)	0.886 \pm 0.059	0.772) 0.971	10
Chloride (%)	0.531 \pm 0.082	0.380) 0.635	10
Sodium (%)	0.316 \pm 0.031	0.258) 0.370	12
Magnesium (%)	0.165 \pm 0.010	0.148) 0.180	12
Sulfur (%)	0.266 \pm 0.060	0.208) 0.420	11
Iron (ppm)	348.0 \pm 83.7	255.0) 523.0	12
Manganese (ppm)	93.27 \pm 5.62	81.7) 102.0	12
Zinc (ppm)	59.42 \pm 9.73	46.1) 81.6	12
Copper (ppm)	11.63 \pm 2.46	8.09) 15.4	12
Iodine (ppm)	3.49 \pm 1.14	1.52) 5.83	11
Chromium (ppm)	1.57 \pm 0.53	0.60) 2.09	12
Cobalt (ppm)	0.81 \pm 0.27	0.49) 1.23	8

TABLE K4
Contaminant Levels in NIH-07 Rat and Mouse Ration^a

	Mean \pm Standard Deviation ^b	Range	Number of Samples
Contaminants			
Arsenic (ppm)	0.52 \pm 0.17	0.10) 0.80	24
Cadmium (ppm)	0.04 \pm 0.01	0.04) 0.06	24
Lead (ppm)	0.24 \pm 0.06	0.20) 0.40	24
Mercury (ppm)	< 0.02		24
Selenium (ppm)	0.34 \pm 0.10	0.10) 0.50	24
Aflatoxins (ppb)	< 5.0		24
Nitrate nitrogen (ppm) ^c	7.76 \pm 2.61	2.90) 14.0	24
Nitrite nitrogen (ppm) ^c	1.37 \pm 0.89	0.30) 3.50	24
BHA (ppm) ^d	1.32 \pm 1.88	0.05) 10.0	24
BHT (ppm) ^d	1.68 \pm 1.14	0.18) 5.0	24
Aerobic plate count (CFU/g)	121,708 \pm 126,261	20,000) 460,000	24
Coliform (MPN/g)	136 \pm 569	3) 2,800	24
<i>Escherichia coli</i> (MPN/g)	6 \pm 3.5	3) 10	24
<i>Salmonella</i> (MPN/g)	Negative		24
Total nitrosoamines (ppb) ^e	12.15 \pm 4.09	4.0) 23.0	24
<i>N</i> -Nitrosodimethylamine (ppb) ^e	10.41 \pm 3.86	3.0) 21.0	24
<i>N</i> -Nitrosopyrrolidine (ppb) ^e	1.74 \pm 0.79	1.0) 4.0	24
Pesticides (ppm)			
α -BHC	< 0.01		24
β -BHC	< 0.02		24
γ -BHC	< 0.01		24
δ -BHC	< 0.01		24
Heptachlor	< 0.01		24
Aldrin	< 0.01		24
Heptachlor epoxide	< 0.01		24
DDE	< 0.01		24
DDD	< 0.01		24
DDT	< 0.01		24
HCB	< 0.01		24
Mirex	< 0.01		24
Methoxychlor	< 0.05		24
Dieldrin	< 0.01		24
Endrin	< 0.01		24
Telodrin	< 0.01		24
Chlordane	< 0.05		24
Toxaphene	< 0.10		24
Estimated PCBs	< 0.20		24
Ronnel	< 0.01		24
Ethion	< 0.02		24
Trithion	< 0.05		24
Diazinon	< 0.10		24
Methyl parathion	< 0.02		24
Ethyl parathion	< 0.02		24
Malathion	0.13 \pm 0.16	0.02) 0.83	24
Endosulfan I	< 0.01		24
Endosulfan II	< 0.01		24
Endosulfan sulfate	< 0.03		24

^a CFU= colony-forming units; MPN= most probable number; BHC= hexachlorocyclohexane or benzene hexachloride

^b For values less than the limit of detection, the detection limit is given as the mean.

^c Sources of contamination: alfalfa, grains, and fish meal

^d Sources of contamination: soy oil and fish meal

^e All values were corrected for percent recovery.

APPENDIX L

SENTINEL ANIMAL PROGRAM

METHODS	228
RESULTS	229

SENTINEL ANIMAL PROGRAM

METHODS

Rodents used in the Carcinogenesis Program of the National Toxicology Program are produced in optimally clean facilities to eliminate potential pathogens that may affect study results. The Sentinel Animal Program is part of the periodic monitoring of animal health that occurs during the toxicologic evaluation of chemical compounds. Under this program, the disease state of the rodents is monitored via serology on sera from extra (sentinel) animals in the study rooms. These animals and the study animals are subject to identical environmental conditions. The sentinel animals come from the same production source and weanling groups as the animals used for the studies of chemical compounds.

Serum samples were collected from randomly selected rats and mice during the 2-year studies. Blood from each animal was collected and allowed to clot, and the serum was separated. The samples were processed appropriately and sent to Microbiological Associates, Inc. (Bethesda, MD), for determination of antibody titers. The laboratory serology methods and viral agents for which testing was performed are tabulated below; the times at which blood was collected during the studies are also listed.

Method and Test

Time of Analysis

RATS

ELISA

Mycoplasma arthritidis

Study termination

Mycoplasma pulmonis

Study termination

PVM (pneumonia virus of mice)

6, 12, and 18 months, study termination

RCV/SDA (rat coronavirus/
sialodacryoadenitis virus)

6, 12, and 18 months, study termination

Sendai

6, 12, and 18 months, study termination

Immunofluorescence Assay

M. arthritidis

Study termination

Hemagglutination Inhibition

H-1 (Toolan's H-1 virus)

6, 12, and 18 months, study termination

KRV (Kilham rat virus)

6, 12, and 18 months, study termination

Method and Test**Time of Analysis****MICE**

ELISA

Ectromelia virus	6, 12, and 18 months, study termination
EDIM (epizootic diarrhea of infant mice)	6, 12, and 18 months, study termination
GDVII (mouse encephalomyelitis virus)	6, 12, and 18 months, study termination
LCM (lymphocytic choriomeningitis virus)	6, 12, and 18 months, study termination
Mouse adenoma virus-FL	6, 12, and 18 months, study termination
MHV (mouse hepatitis virus)	6, 12, and 18 months, study termination
<i>M. arthritis</i>	Study termination
<i>M. pulmonis</i>	Study termination
PVM	6, 12, and 18 months, study termination
Reovirus 3	6, 12, and 18 months, study termination
Sendai	6, 12, and 18 months, study termination

Immunofluorescence Assay

EDIM	12 months
<i>M. arthritis</i>	Study termination
Reovirus 3	18 months, study termination

Hemagglutination Inhibition

K (papovavirus)	6, 12, and 18 months, study termination
MVM (minute virus of mice)	6, 12, and 18 months, study termination
Polyoma virus	6, 12, and 18 months, study termination

RESULTS

Four rats and six mice had positive titers for *M. arthritis*. Further evaluation of samples positive for immunoblot and Western blot procedures indicated that the positive titers may have been due to cross reaction with antibodies of nonpathogenic *Mycoplasma* or other agents. There were no clinical findings or histopathologic changes of *M. arthritis* infection in animals with positive titers. Accordingly, *M. arthritis*-positive titers were considered false positives.

