

NATIONAL TOXICOLOGY PROGRAM
Technical Report Series
No. 461



TOXICOLOGY AND CARCINOGENESIS

STUDIES OF NITROMETHANE

(CAS NO. 75-52-5)

IN F344/N RATS AND B6C3F₁ MICE

(INHALATION STUDIES)

U.S. DEPARTMENT OF HEALTH AND HUMAN SERVICES
Public Health Service
National Institutes of Health

FOREWORD

The National Toxicology Program (NTP) is made up of four charter agencies of the U.S. Department of Health and Human Services (DHHS): the National Cancer Institute (NCI), National Institutes of Health; the National Institute of Environmental Health Sciences (NIEHS), National Institutes of Health; the National Center for Toxicological Research (NCTR), Food and Drug Administration; and the National Institute for Occupational Safety and Health (NIOSH), Centers for Disease Control. In July 1981, the Carcinogenesis Bioassay Testing Program, NCI, was transferred to the NIEHS. The NTP coordinates the relevant programs, staff, and resources from these Public Health Service agencies relating to basic and applied research and to biological assay development and validation.

The NTP develops, evaluates, and disseminates scientific information about potentially toxic and hazardous chemicals. This knowledge is used for protecting the health of the American people and for the primary prevention of disease.

The studies described in this Technical Report were performed under the direction of the NIEHS and were conducted in compliance with NTP laboratory health and safety requirements and must meet or exceed all applicable federal, state, and local health and safety regulations. Animal care and use were in accordance with the Public Health Service Policy on Humane Care and Use of Animals. The prechronic and chronic studies were conducted in compliance with Food and Drug Administration (FDA) Good Laboratory Practice Regulations, and all aspects of the chronic studies were subjected to retrospective quality assurance audits before being presented for public review.

These studies are designed and conducted to characterize and evaluate the toxicologic potential, including carcinogenic activity, of selected chemicals in laboratory animals (usually two species, rats and mice). Chemicals selected for NTP toxicology and carcinogenesis studies are chosen primarily on the bases of human exposure, level of production, and chemical structure. The interpretive conclusions presented in this Technical Report are based only on the results of these NTP studies. Extrapolation of these results to other species and quantitative risk analyses for humans require wider analyses beyond the purview of these studies. Selection *per se* is not an indicator of a chemical's carcinogenic potential.

These NTP Technical Reports are available for sale from the National Technical Information Service, U.S. Department of Commerce, 5285 Port Royal Road, Springfield, VA 22161 (703-487-4650). Single copies of this Technical Report are available without charge while supplies last from NTP Central Data Management, NIEHS, P.O. Box 12233, MD E1-02, Research Triangle Park, NC 27709 (919-541-3419). Listings of all published NTP reports and ongoing studies are also available from NTP Central Data Management. The Abstracts and other study information for 2-year studies are also available at the NTP's World Wide Web site: <http://ntp-server.niehs.nih.gov>.

NTP TECHNICAL REPORT
ON THE
TOXICOLOGY AND CARCINOGENESIS
STUDIES OF NITROMETHANE
(CAS NO. 75-52-5)
IN F344/N RATS AND B6C3F₁ MICE
(INHALATION STUDIES)

NATIONAL TOXICOLOGY PROGRAM
P.O. Box 12233
Research Triangle Park, NC 27709

February 1997

NTP TR 461

NIH Publication No. 97-3377

U.S. DEPARTMENT OF HEALTH AND HUMAN SERVICES
Public Health Service
National Institutes of Health

CONTRIBUTORS

National Toxicology Program

Evaluated and interpreted results and reported findings

J.H. Roycroft, Ph.D., Study Scientist
 G.A. Boorman, D.V.M., Ph.D.
 D.A. Bridge, B.S.
 J.R. Bucher, Ph.D.
 L.T. Burka, Ph.D.
 R.E. Chapin, Ph.D.
 J.R. Hailey, D.V.M.
 J.K. Haseman, Ph.D.
 G.N. Rao, D.V.M., Ph.D.
 G.S. Travlos, D.V.M.
 D.B. Walters, Ph.D.
 K.L. Witt, M.S., Oak Ridge Associated Universities

Battelle Pacific Northwest Laboratories

Conducted studies, evaluated pathology findings

B.J. Chou, D.V.M., Ph.D., Principal Investigator
 S.L. Grumbein, D.V.M., Ph.D.
 R.A. Miller, D.V.M., Ph.D.
 R.J. Weigel, Ph.D.
 R.B. Westerberg, Ph.D.

Experimental Pathology Laboratories, Inc.

Provided pathology quality assurance

J.F. Hardisty, D.V.M., Principal Investigator
 M.R. Wells, D.V.M.

Dynamac Corporation

Prepared quality assurance audits

S. Brecher, Ph.D., Principal Investigator

Biotechnical Services, Inc.

Prepared Technical Report

S.R. Gunnels, M.A., Principal Investigator
 L.M. Harper, B.S.
 D.C. Serbus, Ph.D.
 W.D. Sharp, B.A., B.S.
 S.M. Swift, B.S.

NTP Pathology Working Group

*Evaluated slides, prepared pathology report on rats
 (13 February 1995)*

J.C. Seely, D.V.M., Chairperson
 PATHCO, Inc.
 M.R. Elwell, D.V.M., Ph.D.
 National Toxicology Program
 J.R. Hailey, D.V.M.
 National Toxicology Program
 R.A. Herbert, D.V.M., Ph.D.
 National Toxicology Program
 J.R. Leininger, D.V.M., Ph.D.
 Chemical Industry Institute of Toxicology
 D.E. Malarkey, D.V.M.
 National Toxicology Program (observer)
 A. Radovsky, D.V.M., Ph.D.
 National Toxicology Program
 M.R. Wells, D.V.M.
 Experimental Pathology Laboratories, Inc.

*Evaluated slides, prepared pathology report on mice
 (22 May 1995)*

J.C. Seely, D.V.M., Chairperson
 PATHCO, Inc.
 A. Enomoto, D.V.M.
 National Toxicology Program
 J.R. Hailey, D.V.M.
 National Toxicology Program
 R.A. Herbert, D.V.M., Ph.D.
 National Toxicology Program
 G. Hill, D.V.M.
 North Carolina State University
 R. Miller, D.V.M., Ph.D.
 North Carolina State University
 A. Radovsky, D.V.M., Ph.D.
 National Toxicology Program
 M. Takaoka, D.V.M., Ph.D.
 National Toxicology Program
 M.R. Wells, D.V.M.
 Experimental Pathology Laboratories, Inc.

Analytical Sciences, Inc.

Provided statistical analyses

R.W. Morris, M.S., Principal Investigator
 N.G. Mintz, B.S.
 S. Rosenblum, M.S.

CONTENTS

ABSTRACT	5
EXPLANATION OF LEVELS OF EVIDENCE OF CARCINOGENIC ACTIVITY	11
TECHNICAL REPORTS REVIEW SUBCOMMITTEE	12
SUMMARY OF TECHNICAL REPORTS REVIEW SUBCOMMITTEE COMMENTS	13
INTRODUCTION	15
MATERIALS AND METHODS	21
RESULTS	33
DISCUSSION AND CONCLUSIONS	65
REFERENCES	69
APPENDIX A Summary of Lesions in Male Rats in the 2-Year Inhalation Study of Nitromethane	75
APPENDIX B Summary of Lesions in Female Rats in the 2-Year Inhalation Study of Nitromethane	117
APPENDIX C Summary of Lesions in Male Mice in the 2-Year Inhalation Study of Nitromethane	151
APPENDIX D Summary of Lesions in Female Mice in the 2-Year Inhalation Study of Nitromethane	187
APPENDIX E Genetic Toxicology	227
APPENDIX F Organ Weights and Organ-Weight-to-Body-Weight Ratios	235
APPENDIX G Hematology and Clinical Chemistry Results	241
APPENDIX H Reproductive Tissue Evaluations and Estrous Cycle Characterization	249
APPENDIX I Neurobehavioral Evaluation Results	253
APPENDIX J Chemical Characterization and Generation of Chamber Concentrations	255
APPENDIX K Ingredients, Nutrient Composition, and Contaminant Levels in NIH-07 Rat and Mouse Ration	277
APPENDIX L Sentinel Animal Program	281

ABSTRACT



NITROMETHANE

CAS No. 75-52-5

Molecular Weight: 61.04

Synonym: Nitrocarbol

Nitromethane is used as a rocket and engine fuel; as a synthesis intermediate for agricultural fumigants, biocides, and other products; as a solvent; and as an explosive in mining, oil-well drilling, and seismic exploration. It has been detected in air, in surface and drinking water, and in cigarette smoke. Nitromethane was studied because of the potential for widespread human exposure and because it is structurally related to the carcinogens 2-nitropropane and tetranitromethane. Male and female F344/N rats and B6C3F₁ mice received nitromethane (purity 98% or greater) by inhalation for 16 days, 13 weeks, or 2 years. Genetic toxicology studies were conducted in *Salmonella typhimurium*, cultured Chinese hamster ovary cells, and peripheral blood erythrocytes of mice.

16-DAY STUDY IN RATS

Groups of five male and five female rats were exposed to 0, 94, 188, 375, 750, or 1,500 ppm nitromethane by inhalation, 6 hours per day, 5 days per week, for 16 days. All rats survived until the end of the study. The mean body weight gain of male rats in the 1,500 ppm group was slightly but significantly less than that of the controls; the final mean body weights and mean body weight gains of exposed females were similar to those of the controls. Clinical findings in all male and female rats in the 1,500 ppm groups included increased preening, rapid

breathing, hyperactivity early in the study, and hypoactivity and loss of coordination in the hindlimbs near the end of the study. The relative liver weights of all exposed groups of male rats and the absolute and relative liver weights of females exposed to 375 ppm or greater were significantly greater than those of the controls.

Minimal to mild degeneration of the olfactory epithelium was observed in the nose of males and females exposed to 375 ppm or greater. Sciatic nerve degeneration was present in all male and female rats exposed to 375 ppm or greater; rats exposed to 750 or 1,500 ppm also had reduced myelin around sciatic axons.

16-DAY STUDY IN MICE

Groups of five male and five female mice were exposed to 0, 94, 188, 375, 750, or 1,500 ppm nitromethane by inhalation, 6 hours per day, 5 days per week, for 16 days. All mice survived to the end of the study. The final mean body weights and weight gains of exposed males and females were similar to those of the controls. Clinical findings included hypoactivity and tachypnea in male and female mice in the 1,500 ppm groups. Absolute and relative liver weights of male mice in the 750 and 1,500 ppm groups and female mice in all exposed groups and the relative liver weight of males in the

375 ppm group were significantly greater than those of the controls. Degeneration of the olfactory epithelium of the nose was observed microscopically in all males and females exposed to 375 ppm or greater; this lesion was of minimal severity in males and minimal to mild severity in females.

13-WEEK STUDY IN RATS

Groups of 10 male and 10 female rats were exposed to 0, 94, 188, 375, 750, or 1,500 ppm nitromethane by inhalation, 6 hours per day, 5 days per week, for 13 weeks. All rats survived to the end of the study. The final mean body weight and weight gain of male rats in the 1,500 ppm group were significantly less than those of the controls. Clinical findings included hindlimb paralysis in rats in the 750 and 1,500 ppm groups.

Inhalation exposure of rats to nitromethane resulted in an exposure concentration-dependent, microcytic, responsive anemia; anemia was most pronounced in males and females exposed to 375 ppm or greater. The presence of schistocytes, Heinz bodies, and spherocytes and increased mean cell hemoglobin concentration and methemoglobin concentration were evidence that a hemolytic process was occurring; this hemolytic process could have accounted, in part, for the anemia. Thrombocytosis accompanied the anemia and would be consistent with a reactive bone marrow or could have been due to the erroneous inclusion of small erythrocyte fragments as part of the platelet count. On day 23, transient decreases in serum triiodothyronine, thyroxine, and free thyroxine were observed in male rats exposed to 375 ppm or greater and female rats exposed to 750 or 1,500 ppm. There was little or no pituitary response to the thyroid hormone decreases, as evidenced by the lack of significantly increased concentrations of thyroid-stimulating hormone in exposed rats.

No biologically significant differences in organ weights were observed. The forelimb and hindlimb grip strengths of males in the 1,500 ppm group were significantly less than those of the controls. The hindlimb grip strengths of females in the 750 and 1,500 ppm groups were also significantly less than the control value.

Minimal to mild hyperplasia of the bone marrow was observed microscopically in male rats in the 750 and 1,500 ppm groups and in females exposed to 188 ppm or greater. Nasal lesions in exposed males and females included olfactory epithelial degeneration in males and females exposed to 375 ppm or greater and in one female exposed to 188 ppm and respiratory epithelial hyaline droplets and goblet cell hyperplasia in males and females in the 750 and 1,500 ppm groups; the severity of nasal lesions in males and females was minimal to mild. Males and females exposed to 375 ppm or greater had minimal to mild degeneration of the sciatic nerve and the lumbar spinal cord.

13-WEEK STUDY IN MICE

Groups of 10 male and 10 female mice were exposed to 0, 94, 188, 375, 750, or 1,500 ppm nitromethane by inhalation, 6 hours per day, 5 days per week, for 13 weeks. All mice survived to the end of the study. The final mean body weights and weight gains of exposed mice were generally similar to those of the controls. There were no treatment-related clinical findings.

The absolute right kidney weights of all groups of exposed male mice except the 1,500 ppm group and of females exposed to 188 ppm or greater and the relative right kidney weights of all groups of exposed males and of females in the 750 and 1,500 ppm groups were significantly greater than those of the controls. The absolute liver weight of male mice in the 750 ppm group and the relative liver weights of males exposed to 375 ppm or greater were significantly greater than those of the controls.

Olfactory epithelial degeneration and respiratory epithelial hyaline droplets were observed microscopically in all male and female mice exposed to 375 ppm or greater. Degeneration also occurred in females in the 188 ppm group, and hyaline droplets occurred in females in the 94 and 188 ppm groups. The average severity of the nasal lesions ranged from minimal to mild in males. In females, the average severity of olfactory epithelial degeneration ranged from minimal to mild and the severity of respiratory epithelial hyaline droplets ranged from minimal to

moderate. All males and nine females in the 1,500 ppm groups also had minimal extramedullary hematopoiesis of the spleen.

2-YEAR STUDY IN RATS

Groups of 50 male and 50 female rats were exposed to 0, 94, 188, or 375 ppm nitromethane by inhalation, 6 hours per day, 5 days per week, for 103 weeks.

Survival, Body Weights, and Clinical Findings

There were no significant differences in survival rates between exposed and control male or female rats. The mean body weight of females in the 375 ppm group was slightly greater than that of the control group; the mean body weights of exposed males were generally similar to the mean body weight of the controls throughout the study. Clinical findings were consistent with incidences of mammary gland neoplasms in females exposed to 188 or 375 ppm; no hindlimb paralysis, as occurred in rats in the 13-week study, was observed in male or female rats in the 2-year study.

Pathology Findings

The incidences of mammary gland fibroadenoma and fibroadenoma, adenoma, or carcinoma (combined) in female rats in the 188 and 375 ppm groups were significantly greater than those in the controls. Additionally, the incidence of mammary gland carcinoma in the 375 ppm group was significantly greater than in the controls.

2-YEAR STUDY IN MICE

Groups of 50 male and 50 female mice were exposed to 0, 188, 375, or 750 ppm nitromethane by inhalation, 6 hours per day, 5 days per week, for 103 weeks.

Survival, Body Weights, and Clinical Findings

The survival rate of females in the 750 ppm group was marginally greater than that of the controls. The mean body weights of exposed females were generally slightly greater than the mean body weights of the controls during the study but were generally

similar to the mean body weight of the controls at the end of the study. The mean body weights of exposed males were similar to those of the controls throughout the study. Clinical findings included swelling around the eyes and exophthalmos in exposed males and females; these findings were coincident with harderian gland neoplasms.

Pathology Findings

The incidences of harderian gland adenoma and adenoma or carcinoma (combined) in exposed mice increased with increasing exposure concentration and were significantly greater in males and females in the 375 and 750 ppm groups than those in the controls. The incidences of harderian gland carcinoma in males and females in the 375 and 750 ppm groups were also slightly greater than those in the controls.

Female mice in the 188 and 750 ppm groups had significantly greater incidences of hepatocellular adenoma and hepatocellular adenoma or carcinoma (combined) than the controls. The incidences of liver eosinophilic focus increased with increasing exposure concentration, and the incidences in the 375 and 750 ppm groups were significantly greater than the control incidence.

The incidences of alveolar/bronchiolar carcinoma in male mice in the 750 ppm group and female mice in the 375 ppm group were significantly greater than those in the controls. Females in the 750 ppm group also had a significantly greater incidence of alveolar/bronchiolar adenoma or carcinoma (combined) and a slightly greater incidence of alveolar/bronchiolar adenoma than the controls. Females in the 375 ppm group had a significantly greater incidence of cellular infiltration of histiocytes in the lung than the controls.

The incidences of degeneration and metaplasia of the olfactory epithelium and hyaline degeneration of the respiratory epithelium were significantly greater in exposed male and female mice than those in the controls. Additionally, males in the 375 and 750 ppm groups had significantly greater incidences of inflammation of the nasolacrimal duct than did the controls.

GENETIC TOXICOLOGY

Nitromethane was not mutagenic in any tests performed by the NTP. It did not induce mutations in *Salmonella typhimurium*, with or without S9 metabolic activation, and no induction of sister chromatid exchanges or chromosomal aberrations in cultured Chinese hamster ovary cells exposed to nitromethane was noted with or without S9. No increase in the frequency of micronucleated erythrocytes was observed in peripheral blood samples of male and female mice at the end of the 13-week inhalation study of nitromethane.

CONCLUSIONS

Under the conditions of these 2-year inhalation studies, there was *no evidence of carcinogenic activity** of nitromethane in male F344/N rats exposed to 94, 188, or 375 ppm. There was *clear*

evidence of carcinogenic activity of nitromethane in female F344/N rats based on increased incidences of mammary gland fibroadenomas and carcinomas. There was *clear evidence of carcinogenic activity* of nitromethane in male B6C3F₁ mice based on increased incidences of harderian gland adenomas and carcinomas. There was *clear evidence of carcinogenic activity* in female B6C3F₁ mice, based on increased incidences of liver neoplasms (primarily adenomas) and harderian gland adenomas and carcinomas. Increased incidences of alveolar/bronchiolar adenomas and carcinomas in male and female mice exposed to nitromethane were also considered to be related to chemical administration.

Exposure to nitromethane by inhalation for 2 years resulted in increased incidences of nasal lesions including degeneration and metaplasia of the olfactory epithelium and degeneration of the respiratory epithelium in male and female mice.

* Explanation of Levels of Evidence of Carcinogenic Activity is on page 11. A summary of the Technical Reports Review Subcommittee comments and the public discussion on this Technical Report appears on page 13.

Summary of the 2-Year Carcinogenesis and Genetic Toxicology Studies of Nitromethane

	Male F344/N Rats	Female F344/N Rats	Male B6C3F ₁ Mice	Female B6C3F ₁ Mice
Exposure concentrations	0, 94, 188, or 375 ppm	0, 94, 188, or 375 ppm	0, 188, 375, or 750 ppm	0, 188, 375, or 750 ppm
Body weights	Exposed groups similar to controls	375 ppm group slightly greater than controls	Exposed groups similar to controls	Exposed groups similar to controls
2-Year survival rates	13/50, 16/50, 14/50, 8/50	28/50, 19/50, 30/50, 23/50	31/50, 36/50, 30/50, 29/50	25/50, 28/50, 26/50, 36/50
Nonneoplastic effects	None	None	<u>Nose:</u> olfactory epithelium, degeneration (0/50, 10/49, 50/50, 50/50); olfactory epithelium, metaplasia (0/50, 1/49, 41/50, 49/50); respiratory epithelium, hyaline degeneration (5/50, 5/49, 50/50, 50/50)	<u>Nose:</u> olfactory epithelium, degeneration (0/50, 22/49, 50/50, 50/50); olfactory epithelium, metaplasia (0/50, 2/49, 46/50, 48/50); respiratory epithelium, hyaline degeneration (16/50, 39/49, 50/50, 50/50)
Neoplastic effects	None	<u>Mammary gland:</u> fibroadenoma (19/50, 21/50, 33/50, 36/50); carcinoma (2/50, 7/50, 1/50, 11/50); fibroadenoma, adenoma, or carcinoma (21/50, 25/50, 34/50, 41/50)	<u>Harderian gland:</u> adenoma (9/50, 10/50, 19/50, 32/50); carcinoma (1/50, 1/50, 6/50, 5/50); adenoma or carcinoma (10/50, 11/50, 25/50, 37/50) <u>Lung:</u> alveolar/bronchiolar carcinoma (2/50, 3/50, 3/50, 11/50); alveolar/bronchiolar adenoma or carcinoma (13/50, 13/50, 12/50, 20/50)	<u>Harderian gland:</u> adenoma (5/50, 7/50, 16/50, 19/50); adenoma or carcinoma (6/50, 9/50, 20/50, 21/50) <u>Liver:</u> hepatocellular adenoma (14/50, 25/49, 17/49, 35/50); hepatocellular adenoma or carcinoma (19/50, 34/49, 22/49, 40/50) <u>Lung:</u> alveolar/bronchiolar adenoma (3/50, 3/50, 2/49, 9/50); alveolar/bronchiolar carcinoma (0/50, 3/50, 5/49, 3/50); alveolar/bronchiolar adenoma or carcinoma (3/50, 6/50, 6/49, 12/50)
Level of evidence of carcinogenic activity	No evidence	Clear evidence	Clear evidence	Clear evidence

Summary of the 2-Year Carcinogenesis and Genetic Toxicology Studies of Nitromethane (continued)

Genetic toxicology

<i>Salmonella typhimurium</i> gene mutations:	Negative in strains TA98, TA100, TA1535, and TA1537 with and without S9
Sister chromatid exchanges	
Cultured Chinese hamster ovary cells <i>in vitro</i> :	Negative with and without S9
Chromosomal aberrations	
Cultured Chinese hamster ovary cells <i>in vitro</i> :	Negative with and without S9
Micronucleated erythrocytes	
Mouse peripheral blood <i>in vivo</i> :	Negative

EXPLANATION OF LEVELS OF EVIDENCE OF CARCINOGENIC ACTIVITY

The National Toxicology Program describes the results of individual experiments on a chemical agent and notes the strength of the evidence for conclusions regarding each study. Negative results, in which the study animals do not have a greater incidence of neoplasia than control animals, do not necessarily mean that a chemical is not a carcinogen, inasmuch as the experiments are conducted under a limited set of conditions. Positive results demonstrate that a chemical is carcinogenic for laboratory animals under the conditions of the study and indicate that exposure to the chemical has the potential for hazard to humans. Other organizations, such as the International Agency for Research on Cancer, assign a strength of evidence for conclusions based on an examination of all available evidence, including animal studies such as those conducted by the NTP, epidemiologic studies, and estimates of exposure. Thus, the actual determination of risk to humans from chemicals found to be carcinogenic in laboratory animals requires a wider analysis that extends beyond the purview of these studies.

Five categories of evidence of carcinogenic activity are used in the Technical Report series to summarize the strength of the evidence observed in each experiment: two categories for positive results (**clear evidence** and **some evidence**); one category for uncertain findings (**equivocal evidence**); one category for no observable effects (**no evidence**); and one category for experiments that cannot be evaluated because of major flaws (**inadequate study**). These categories of interpretative conclusions were first adopted in June 1983 and then revised in March 1986 for use in the Technical Report series to incorporate more specifically the concept of actual weight of evidence of carcinogenic activity. For each separate experiment (male rats, female rats, male mice, female mice), one of the following five categories is selected to describe the findings. These categories refer to the strength of the experimental evidence and not to potency or mechanism.

- **Clear evidence** of carcinogenic activity is demonstrated by studies that are interpreted as showing a dose-related (i) increase of malignant neoplasms, (ii) increase of a combination of malignant and benign neoplasms, or (iii) marked increase of benign neoplasms if there is an indication from this or other studies of the ability of such tumors to progress to malignancy.
- **Some evidence** of carcinogenic activity is demonstrated by studies that are interpreted as showing a chemical-related increased incidence of neoplasms (malignant, benign, or combined) in which the strength of the response is less than that required for clear evidence.
- **Equivocal evidence** of carcinogenic activity is demonstrated by studies that are interpreted as showing a marginal increase of neoplasms that may be chemical related.
- **No evidence** of carcinogenic activity is demonstrated by studies that are interpreted as showing no chemical-related increases in malignant or benign neoplasms.
- **Inadequate study** of carcinogenic activity is demonstrated by studies that, because of major qualitative or quantitative limitations, cannot be interpreted as valid for showing either the presence or absence of carcinogenic activity.

When a conclusion statement for a particular experiment is selected, consideration must be given to key factors that would extend the actual boundary of an individual category of evidence. Such consideration should allow for incorporation of scientific experience and current understanding of long-term carcinogenesis studies in laboratory animals, especially for those evaluations that may be on the borderline between two adjacent levels. These considerations should include:

- adequacy of the experimental design and conduct;
- occurrence of common versus uncommon neoplasia;
- progression (or lack thereof) from benign to malignant neoplasia as well as from preneoplastic to neoplastic lesions;
- some benign neoplasms have the capacity to regress but others (of the same morphologic type) progress. At present, it is impossible to identify the difference. Therefore, where progression is known to be a possibility, the most prudent course is to assume that benign neoplasms of those types have the potential to become malignant;
- combining benign and malignant tumor incidence known or thought to represent stages of progression in the same organ or tissue;
- latency in tumor induction;
- multiplicity in site-specific neoplasia;
- metastases;
- supporting information from proliferative lesions (hyperplasia) in the same site of neoplasia or in other experiments (same lesion in another sex or species);
- presence or absence of dose relationships;
- statistical significance of the observed tumor increase;
- concurrent control tumor incidence as well as the historical control rate and variability for a specific neoplasm;
- survival-adjusted analyses and false positive or false negative concerns;
- structure-activity correlations; and
- in some cases, genetic toxicology.

**NATIONAL TOXICOLOGY PROGRAM BOARD OF SCIENTIFIC COUNSELORS
TECHNICAL REPORTS REVIEW SUBCOMMITTEE**

The members of the Technical Reports Review Subcommittee who evaluated the draft NTP Technical Report on nitromethane on December 5, 1995, are listed below. Subcommittee members serve as independent scientists, not as representatives of any institution, company, or governmental agency. In this capacity, subcommittee members have five major responsibilities in reviewing NTP studies:

- to ascertain that all relevant literature data have been adequately cited and interpreted,
- to determine if the design and conditions of the NTP studies were appropriate,
- to ensure that the Technical Report presents the experimental results and conclusions fully and clearly,
- to judge the significance of the experimental results by scientific criteria, and
- to assess the evaluation of the evidence of carcinogenic activity and other observed toxic responses.

Arnold L. Brown, M.D., Chair
University of Wisconsin Medical School
Madison, WI

Gary P. Carlson, Ph.D.
School of Health Sciences
Purdue University
West Lafayette, IN

Thomas L. Goldsworthy, Ph.D.
Department of Experimental Pathology and Toxicology
Chemical Industry Institute of Toxicology
Research Triangle Park, NC

Robert LeBoeuf, Ph.D., Principal Reviewer
Corporate Professional and Regulatory Services
Human Safety Department
The Procter & Gamble Company
Cincinnati, OH

Janardan K. Reddy, M.D.*
Department of Pathology
Northwestern University Medical School
Chicago, IL

Irma Russo, M.D., Principal Reviewer
Fox Chase Cancer Center
Philadelphia, PA

Louise Ryan, Ph.D., Principal Reviewer
Division of Biostatistics
Dana-Farber Cancer Institute
Boston, MA

Robert E. Taylor, M.D., Ph.D.
Department of Pharmacology
Howard University College of Medicine
Washington, DC

Frederick L. Tyson, Ph.D.
St. Mary's Hospital and Medical Center
Cancer Research Institute
Grand Junction, CO

Jerrold M. Ward, D.V.M., Ph.D.*
National Cancer Institute
Frederick, MD

* Did not attend

SUMMARY OF TECHNICAL REPORTS REVIEW SUBCOMMITTEE COMMENTS

On December 5, 1995, the draft Technical Report on the toxicity and carcinogenesis studies of nitromethane received public review by the National Toxicology Program's Board of Scientific Counselors' Technical Reports Review Subcommittee. The review meeting was held at the National Institute of Environmental Health Sciences, Research Triangle Park, NC.

Dr. J.H. Roycroft, NIEHS, introduced the toxicity and carcinogenesis studies of nitromethane by discussing the uses, describing the experimental design, reporting on the survival and body weight effects, and commenting on chemical-related neoplastic lesions in female rats and male and female mice and nonneoplastic lesions in male and female mice. The proposed conclusions for the 2-year studies in rats and mice were *no evidence of carcinogenic activity* in male F344/N rats and *clear evidence of carcinogenic activity* in female F344/N rats and male and female B6C3F₁ mice.

Dr. Russo, a principal reviewer, agreed with the proposed conclusions and found the report otherwise acceptable.

Dr. Ryan, the second principal reviewer, agreed with the proposed conclusions. She noted that 375 ppm female rats weighed more than the controls and wondered whether this could be related to chemical effects on the thyroid gland and, further, what impact the weight effect might have had on the increased incidence of mammary gland tumors. Dr. Roycroft responded that transient thyroid gland effects were seen early in the 13-week studies but not at the end and were not observed in the 2-year study, so he did not think the thyroid gland had an impact. Dr. J.K. Haseman, NIEHS, described a model developed by Dr. S. Seilkop using NTP historical control data to predict how certain tumors are affected by body weight and how body weights at certain ages are predictive of subsequent tumor development. Using the model, one would predict a 51% incidence of mammary gland tumors in

375 ppm female rats, while the actual incidence in the study was 82%. Dr. Haseman said in this case the increase in body weights could not account for the increase in tumors.

Dr. LeBoeuf, the third principal reviewer, agreed with the proposed conclusions in principle. He questioned whether the increases in hepatocellular adenomas alone in female mice were sufficient to support the conclusion of clear evidence. Dr. Roycroft said the incidences of 51% and 70% in the 188 and 750 ppm groups well exceeded the concurrent control incidence of 28% as well as the highest historical rate of 40% in any of the contemporary inhalation studies and justified their inclusion as support. Dr. LeBoeuf commented that since neurotoxicity was the prime determinant for dose setting for the 2-year rat study, there should have been histopathologic examination of sciatic nerve and spinal cord in animals from this study. Dr. Roycroft observed that the 13-week data indicated sciatic nerve degeneration was less severe than in the 16-day study, although there were obvious clinical observations in the longer study. He noted that the standard protocol calls for cutting sections of sciatic nerve, spinal cord, and other nervous system tissues when neurobehavioral effects are seen clinically, but such effects were not seen in the 2-year nitromethane study. However, Dr. Roycroft reported that subsequently, sections were taken from 375 ppm and control animals, and none of the lesions observed in prechronic studies were seen.

Dr. A. Bollmeier, Angus Chemical Company, said Angus was essentially the only manufacturer of nitroparaffins now in the country. He pointed out the variation among the three batches used for the studies and wondered if this might not play a role in differences in toxicology findings among the 16-day, 13-week, and 2-year studies. Dr. Bollmeier commented that the potential for human exposure estimates by NIOSH were done in 1981 to 1983, while current exposures would be much less, likely less than 10,000.

Dr. Russo moved that the Technical Report on nitromethane be accepted with the revisions discussed and with the conclusions as written. Dr. Ryan seconded the motion. Dr. J.R. Bucher, NIEHS, asked that the wording of the statement supporting the level of evidence for female mice be changed to add 'adenomas' after 'liver.' Dr. Brown said this would not be an amendment but should be kept in mind by the members when voting. Dr. Goldsworthy commented that one could argue for

the same change with the harderian gland in female mice as the tumor response in this organ is primarily driven by the adenomas. Dr. Bucher proposed also using the less specific word 'neoplasm.' The revised sentence could read: "There was *clear evidence of carcinogenic activity* in female mice based on increased incidences of liver neoplasms (primarily adenomas) and harderian gland adenomas and carcinomas." The motion by Dr. Russo was then accepted unanimously with seven votes.

INTRODUCTION



NITROMETHANE

CAS No. 75-52-5

Molecular Weight: 61.04

Synonym: Nitrocarbol

CHEMICAL AND PHYSICAL PROPERTIES

Nitromethane is a colorless, oily liquid with a moderately strong, disagreeable odor (*Merck Index*, 1989). Nitromethane has a melting point of -29°C , a boiling point of 101.2°C , a flash point of 112°F , and a lower explosive limit of 7.3%. Its density is 1.1322 at 25°C ; the vapor density is 2.11 and the vapor pressure is 27.8 mm Hg at 20°C . Nitromethane is soluble in alcohol, ether, *N,N*-dimethylformamide, acetone, and alkali and is slightly soluble in water (9.5 g/L at 20°C). Nitromethane will explode when heated under confinement to near its critical temperature (315°C) or when rapidly compressed under adiabatic conditions. The sodium salt is also explosive and bursts into flames upon contact with water.

PRODUCTION, USE, AND HUMAN EXPOSURE

Nitromethane can be prepared by vapor phase nitration of propane or by the reaction of sodium nitrite with sodium chloroacetate (*Merck Index*, 1989). In the past, nitromethane was used extensively as a chemical stabilizer to prevent the decomposition of various halogenated hydrocarbons such as metal degreasers and aerosol propellants such as 1,1,1-trichloroethane. Nitromethane is used as a fuel or fuel additive to increase the power output of rockets,

racing cars, boats, and model engines. Nitromethane is also used as a synthesis intermediate for a variety of chemicals, such as trichloronitromethane (chloropicrin), an agricultural soil and grain fumigant; the nitroalcohol, 2-hydroxymethyl-2-nitro-1,3-propanediol, which is used as a biocide for cutting fluids and as a source of formaldehyde for cross-linking amino resins; and the alkanolamine, 2-hydroxymethyl-2-amino-1,3-propanediol, which is used as a formaldehyde scavenger in resin curing and polyester resin modification and as a buffer. Nitromethane is used in a variety of solvent applications, such as solvent-extraction separation of aromatics from aliphatic compounds, in the crystallization of nitrofurantoin, as a reaction medium for aluminum chloride in Friedel-Crafts reactions, and as a solvent for resins such as α -cyanoacrylate. Nitromethane is used in mixtures with ammonium nitrate as an explosive in mining, oil-well drilling, and seismic exploration (*Biocides, U.S.A.*, 1974; *Remington's Pharmaceutical Sciences*, 1975; *Kirk-Othmer*, 1978, 1981; SRI, International, 1980).

Although nitromethane was reported to the U.S. International Trade Commission for the year 1992, the production volume was not published (USITC, 1994). According to the National Occupational Exposure Survey, approximately 135,000 male and 46,500 female workers in the U.S. were potentially exposed to nitromethane during the years 1981 to

1983 (NIOSH, 1990). The time-weighted average threshold limit value for nitromethane is 20 ppm, or 50 mg/m³ (ACGIH, 1995). The exposure limit of nitromethane permitted by Occupational Safety and Health Administration is 100 ppm or 250 mg/m³ (29 CFR, § 1910). Although an odor threshold of 3.5 ppm has been reported for nitromethane, the odor and sensory symptoms are not dependable warning properties (Davis, 1993). Products containing nitromethane are not widely used by consumers; therefore, consumer exposure to nitromethane from such products is presumed to be low.

Nitromethane has been detected in air and in surface and drinking water; its occurrence in the atmosphere results either from emissions from industrial processes or from its formation as a byproduct of certain chemical reactions. Nitromethane is found in cigarette smoke and is a byproduct of hydrocarbon combustion and munitions manufacture. It is possibly synthesized in the atmosphere by the photolytic reaction of nitrogen dioxide and ethylene.

Nitromethane is fairly reactive and therefore does not persist in the environment; the half-life ($t_{1/2}$) of nitromethane is from 4 to 9 hours in air and about 1 day in water (National Library of Medicine, 1995a). However, because nitromethane is slightly soluble in water and evaporates at about the same rate as water, the $t_{1/2}$ is somewhat dependent on the rate of evaporation. In the atmosphere and in water, nitromethane is degraded through its reaction with hydroxyl radicals; it may also undergo aerobic or anaerobic degradation. It may react with chlorine in water to form trichloronitromethane if the pH of the medium is high (Wade *et al.*, 1977).

ABSORPTION, DISTRIBUTION, METABOLISM, AND EXCRETION

Experimental Animals

Nitromethane is oxidized *in vitro* to formaldehyde, nitrite, and hydrogen peroxide by D-amino acid oxidase prepared from hog kidney (Porter *et al.*, 1972). However, when incubated with rat nasal and liver microsomes to determine if the cytochrome P₄₅₀-dependent demethylation produces formaldehyde, no formaldehyde was generated from nasal microsomes and only a trace was generated from liver

microsomes (Dahl and Hadley, 1983). Flavoenzymes also oxidize nitromethane. Nitromethane inhibits rabbit liver cytochrome P₄₅₀ activity, apparently competing for the same ferrohemochrome-binding sites as carbon monoxide (Wade *et al.*, 1977). Dequidt *et al.* (1973) administered nitromethane to Wistar rats by intraperitoneal injection (2,400 mg/kg) or by inhalation (13,000 ppm for 6 hours) and measured nitrite and methemoglobin concentrations in exposed animals. No methemoglobin was detected in rats treated with nitromethane by either route; nitrite was detected in low concentrations in the heart, lungs, kidneys, and spleen, but not the liver, of rats treated by each route. Following daily 6-hour inhalation exposures to 2,500 ppm nitromethane for 4 days, nitrite concentrations in heart, lung, kidney, and spleen tissues of Wistar rats were similar to those observed following a single exposure. No unchanged nitromethane was present in the organs of animals administered nitromethane intraperitoneally. In rats exposed by inhalation, nitromethane was detected only in the liver (0.27 g/100 g) and was not detected in rats exposed to less than 13,000 ppm.

Humans

No studies of absorption, distribution, metabolism, and excretion of nitromethane in humans were found in the literature (National Library of Medicine, 1995b).

TOXICITY

Experimental Animals

Oral LD₅₀ values range from 940 to 1,210 mg/kg for rats (Subbotin, 1967; International Technical Information Institute, 1979) and from 950 to 1,440 mg/kg for mice (Machle *et al.*, 1940). In an early study of nitromethane toxicity performed by Gibbs and Reichert (1891), a minimum lethal dose of 565 to 1,130 mg/kg for dogs was reported. Injections of nitromethane caused lassitude, drowsiness, weakness, salivation, urination, defecation, and vomiting. Nitromethane first accelerated, then retarded, the pulse rate. Treated dogs exhibited progressive weakness, coma, paralysis, and terminal convulsions. Death by respiratory failure usually occurred within 24 hours of injection.

Dogs that were administered a single oral dose of nitromethane at a concentration of 200, 500, 1,000,

or 1,500 mg/kg died within 36 hours (Weatherby, 1955). Pathologic examination revealed hepatic edema, focal areas of necrosis, and cells with enlarged nuclei. Pathologic examinations performed on dogs that were administered a single, nonlethal oral dose of 125 mg/kg nitromethane revealed slight changes in the liver, including mild fatty change of the hepatic parenchyma and a few lymphocytes in the portal areas. Within 48 hours after dosing, regeneration of hepatic cells was observed. Liver damage was more severe as the dose was increased. Kidney damage (swollen glomeruli, swollen proximal and distal convoluted tubules, and hyaline casts in the tubules) was observed only in animals administered 1,500 mg/kg. All other tissues were normal.

Rabbits receiving gavage doses of 750 to 1,000 mg/kg nitromethane displayed progressive weakness and collapse, unsteadiness and incoordination ending in complete ataxia; their breathing was first slowed, then rapid (Machle *et al.*, 1940). There were no changes in blood chemistry variables and no methemoglobin formation. Liver damage (edema, cloudy swelling, and necrosis) was present in all animals that died from administration of the chemical. Inhalation experiments with rabbits, monkeys, and guinea pigs were also performed. The symptoms of nitromethane toxicity following inhalation were similar for each species, although guinea pigs seemed to be somewhat more susceptible than rabbits or monkeys (Machle *et al.*, 1940). Mortality was related to total dose (concentration of exposure multiplied by duration) at concentrations greater than 500 ppm. The LC_{50} for monkeys was determined to be 1,000 ppm. Rabbits and guinea pigs (two of each species) survived exposure to 30,000 ppm for 15 minutes or 10,000 ppm for 1 hour; however, all died when exposed to 30,000 ppm for 2 hours or 10,000 ppm for 6 hours (Machle *et al.*, 1940). A latency period was observed before the onset of symptoms of nitromethane toxicity and was inversely related to the concentration of nitromethane in the air. Central nervous system effects were observed within 30 minutes to 1 hour after exposure to 30,000 or 50,000 ppm; however, in animals exposed to 10,000 ppm, central nervous system effects were not observed until 5 hours after exposure began. Inhalation of nitromethane first caused restlessness and slight irritation of the respiratory tract. After the latency period, the animals began salivating,

appeared ill, and showed signs of narcosis. As the exposure period progressed, the animals became weak, ataxic, and incoordinated and often exhibited circular movement, convulsions, and twitching. At necropsy, all exposed animals were found to have some liver damage (edema and necrosis). Animals that died from nitromethane inhalation exhibited general visceral and cerebral congestion and acute pulmonary congestion with edema. Application of nitromethane (dose not specified) to the clipped skin of rabbits caused neither skin irritation nor compound-related clinical findings (Machle *et al.*, 1940). In a study comparing hepatotoxicity, groups of three to five BALB/C mice were injected intraperitoneally with 275, 410, or 550 mg nitromethane, 2-nitropropane, or nitroethane per kilogram body weight and were killed 24, 48, 72, or 96 hours after dosing (Dayal *et al.*, 1989). Nitromethane and nitroethane were not hepatotoxic; treatment with 550 mg/kg 2-nitropropane caused increases in plasma sorbitol dehydrogenase, alanine aminotransferase, and aspartate aminotransferase activities and caused necrosis, degeneration, and cell proliferation in the liver.

Nitromethane has been used experimentally to cause histidinemia in inbred, weanling male Sprague-Dawley rats (Douay and Kamoun, 1980). The rats were injected subcutaneously with nitromethane at the rate of 0.8 mL of 110 g/L per 100 g body weight once daily for 6 days. Liver histidase in treated rats was 30% that of untreated control animals, while plasma, liver, and brain histidine increased threefold. Paralysis was observed in 61% of treated animals, while 15% displayed seizures. The rate of body weight gain was significantly reduced. No effect was observed on brain serotonin content or in plasma free amino acid concentrations. These findings indicate that animal histidinemia produced by nitromethane treatment is similar to human histidinemia.

In a study comparing the acute toxic effects of nitromethane and nitroethane, 3-month-old male Wistar rats were dosed intraperitoneally with 200 mg/kg of either compound (Zitting *et al.*, 1982). The rats were examined after 4, 24, or 48 hours. Both nitromethane and nitroethane caused an increase in brain acid proteinase and acetylcholine esterase activities. Nitromethane decreased NADPH-cytochrome C reductase activity in liver microsomes.

Nitroethane depressed 7-ethoxycoumarin *O*-deethylase and NADPH-cytochrome C reductase but increased epoxide hydrolase and UDP-glucuronosyltransferase activities in liver microsomes. In an earlier study, 2-nitropropane was shown to cause an increase in hepatic epoxide hydrolase and UDP-glucuronosyltransferase and brain acetylcholine esterase activities (Zitting *et al.*, 1982). Rats and rabbits provided drinking water containing 23, 47, or 94 mg nitromethane per kilogram body weight for 2 months had increased alanine transaminase and aspartate transaminase activities and α - and γ -globulin concentrations, liver impairment (decreased plasma prothrombin), and increased whole blood cholinesterase; there were no effects on blood cell morphology (Subbotin, 1967). However, in studies in which rats and rabbits were provided drinking water containing 0.05, 0.5, or 12.5 mg/kg nitromethane for 6 months, serum alanine and aspartate transaminase activities were increased only in animals administered 12.5 mg/kg (Subbotin, 1967).

In a 6-month inhalation study, Sprague-Dawley rats and New Zealand white rabbits were exposed to 98 or 745 ppm nitromethane or 27 or 207 ppm 2-nitropropane for 7 hours per day, 5 days per week, for 6 months (Lewis *et al.*, 1979). Interim evaluations were conducted on days 2 and 10 for rats and at 1 and 3 months for rats and rabbits. No deaths were attributed to nitromethane or 2-nitropropane administration in either species. Rats exposed to 745 ppm nitromethane did not gain weight as rapidly as the controls. There were no effects on hematologic parameters, prothrombin time, or alanine transaminase activity in either species, and no methemoglobin was produced in animals exposed to nitromethane. Rabbits in both groups exposed to nitromethane had depressed serum thyroxin concentrations throughout the study (statistically significant at 1 month for the 745 ppm group and at 6 months for both groups); this effect did not occur in animals exposed to 2-nitropropane. Rats and rabbits exposed to 745 ppm nitromethane also had greater thyroid gland weights than the controls. At all time points, lung weights of rats exposed to nitromethane were reduced. Lung and liver weights of rats exposed to 207 ppm 2-nitropropane were significantly increased at 3 and 6 months; 2-nitropropane did not cause organ weight effects in rabbits. There were no histopathologic

changes related to nitromethane treatment in rats or rabbits at either concentration at any evaluation period. However, rats exposed to 207 ppm 2-nitropropane for 3 months had focal hepatocellular hypertrophy with large hepatocytes and basophilic foci containing small hyperplastic foci. Following 6 months of exposure to 207 ppm 2-nitropropane, all rats had multiple hepatocellular carcinomas (Lewis *et al.*, 1979).

In a study to investigate the potential hepatotoxicity of 1-nitropropane, Griffin *et al.* (1982) exposed male and female Long-Evans rats to 100 ppm 1-nitropropane by inhalation for 7 hours per day, 5 days per week, for up to 21½ months. No treatment-related mortality, weight-gain effects, clinical signs, or effects on hematologic indices were observed. 1-Nitropropane exposure did not cause changes in clinical chemistry indices indicative of hepatotoxicity. No neoplasms or nonneoplastic lesions were attributed to exposure; the liver effects observed in the 2-nitropropane study (Lewis *et al.*, 1979) did not occur in rats exposed to 1-nitropropane.

Male and female Long-Evans rats exposed to 100 or 200 ppm nitroethane by inhalation for 7 hours per day, 5 days per week, for 2 years had no treatment-related mortality or effects on body weight gains (Griffin *et al.*, 1988). Hematology and clinical chemistry evaluations performed at the end of the study indicated no treatment-related effects. Additionally, there were no neoplasms or nonneoplastic lesions associated with nitroethane exposure.

Humans

No epidemiological studies of nitromethane alone were found in the literature (National Library of Medicine, 1995b). The estimated oral LD₅₀ for humans is 500 mg/kg (Gosselin *et al.*, 1984). Nitromethane and its decomposition products are toxic if ingested or inhaled. Eye and skin irritation has occurred from repeated exposure.

REPRODUCTIVE AND DEVELOPMENTAL TOXICITY

No information on the reproductive or developmental toxicity of nitromethane in experimental animals or

in humans was found in the literature (National Library of Medicine, 1995b).

CARCINOGENICITY

No information on the carcinogenicity of nitromethane in experimental animals was found in the literature; additionally, no epidemiological studies or case reports examining the relationship between exposure to nitromethane and human cancer were found in the literature (National Library of Medicine, 1995b). As discussed previously, Sprague-Dawley rats exposed to 207 ppm 2-nitropropane by inhalation for 6 months had multiple hepatocellular carcinomas (Lewis *et al.*, 1979). Male and female Long-Evans rats exposed to 100 or 200 ppm nitroethane by inhalation for 2 years (Griffin *et al.*, 1988) or to 100 ppm 1-nitropropane by inhalation for 21½ months (Griffin *et al.*, 1982) had no neoplasms or nonneoplastic lesions associated with treatment.

GENETIC TOXICITY

Little information is available on the mutagenicity of nitromethane, but the results of published studies are uniformly negative. Results for induction of mutations in *Salmonella typhimurium* strains TA98, TA100, TA1535, and TA1537 by nitromethane were negative with and without S9 metabolic activation in tests incorporating either the standard plate assay or preincubation (Chiu *et al.*, 1978; Mortelmans *et al.*, 1986; Dayal *et al.*, 1989; Dellarco and Prival, 1989). The nitronate form of nitromethane was negative for induction of mutations in *S. typhimurium* strains

TA100 and TA102 (Dayal *et al.*, 1989). No significant increases in sex-linked recessive lethal mutations were noted in germ cells of male *Drosophila melanogaster* after administration of nitromethane by feeding (Gocke *et al.*, 1981). No induction of micronuclei was observed in bone marrow polychromatic erythrocytes of male NMRI mice administered two intraperitoneal injections of 205 to 1,830 mg nitromethane per kilogram body weight (Gocke *et al.*, 1981). In this test, bone marrow was sampled 6 hours after the second injection, so the effect of the second treatment is not likely to be reflected in these results; 24 hours is the preferred interval between treatment and observation of induced micronuclei. However, this negative result is in agreement with the results of the 13-week micronucleus study conducted by the NTP and presented in this report (Appendix E).

STUDY RATIONALE

Nitromethane was the sole chemical selected from the amines, amides, nitros, nitriles, ureas, and carbamates subclass of air pollutants and was subsequently nominated to the NTP for toxicity and carcinogenicity testing by the National Cancer Institute based on its high potential for human exposure and its structural relationship to 2-nitropropane and tetranitromethane, known animal carcinogens (NTP, 1990, 1994). Inhalation was chosen as the route of exposure because of the volatility of the chemical and because human exposure would likely occur by this route.

MATERIALS AND METHODS

PROCUREMENT AND CHARACTERIZATION OF NITROMETHANE

Nitromethane was obtained from W.R. Grace and Company (Lexington, MA) in three lots. Lot 1F 13 06 was used during the 16-day studies and the beginning of the 13-week studies; lot 1-H-0501 was used throughout the remainder of the 13-week studies and at the beginning of the 2-year studies. Lot 1-H-1004 was used throughout the remainder of the 2-year studies. Identity, purity, and stability analyses were conducted by the analytical chemistry laboratory, Midwest Research Institute (Kansas City, MO). Reports on the analyses performed in support of the nitromethane studies are on file at the National Institute of Environmental Health Sciences. The methods and results of these studies are detailed in Appendix J. The chemical, a clear, colorless liquid, was identified as nitromethane by infrared, ultraviolet/visible, and nuclear magnetic resonance spectrometry. The purity of each lot was determined by elemental analysis, Karl Fischer water analysis, functional group titration, and two gas chromatographic systems.

For lot 1F 13 06, elemental analyses of carbon and hydrogen agreed with the theoretical values for nitromethane, but results for nitrogen were low. Karl Fischer water analysis indicated $0.022\% \pm 0.004\%$ water. Functional group titration indicated a purity of $100\% \pm 1\%$. Both gas chromatographic systems indicated one impurity with an area greater than 0.1% relative to the major peak. The area of the impurity peak was 0.62% relative to the major peak by one gas chromatographic system and 0.52% relative to the major peak by the second system. The overall purity of lot 1F 13 06 was determined to be approximately 99%. Gas chromatography/mass spectrometry used to identify the impurity indicated that the mass spectrum of the impurity was consistent with that of propionitrile; an additional impurity observed in the sample was

identified as 2-nitropropane. The quantity of propionitrile was determined with gas chromatography to be $0.400\% \pm 0.001\%$; the quantity of 2-nitropropane was determined to be $0.017\% \pm 0.000\%$.

For lot 1-H-0501 (batch 2), the supplier indicated a purity of 99.3% for the bulk chemical, with 0.27% nitroethane present as a contaminant. Elemental analyses of carbon and hydrogen by the analytical chemistry laboratory agreed with the theoretical values for nitromethane, but results for nitrogen were low. Karl Fischer water analysis indicated $0.018\% \pm 0.003\%$ water. Functional group titration indicated a purity of $98.9\% \pm 0.8\%$. Gas chromatography indicated three impurities with a combined area of 1.69% relative to the major peak by one system and two impurities with a combined area of 1.49% relative to the major peak by the second system. Batch 3 of lot 1-H-0501 was also analyzed with gas chromatographic system A; one major peak and three impurities with a total peak area 1.71% relative to the major peak were identified. Major peak comparisons of batch 2 with lot 1F 13 06 and of batch 3 with batch 2 were performed with gas chromatography; the results indicated a purity of $99.3\% \pm 0.3\%$ for batch 2 of lot 1-H-0501 relative to lot 1F 13 06 and a purity of $99.5\% \pm 0.5\%$ for batch 3 relative to batch 2. The overall purity of lot 1-H-0501 was determined to be approximately 98%.

For lot 1-H-1004, the supplier indicated a 99% purity of the bulk chemical, with nitroethane (0.25%) and 2-nitropropane (0.03%) present as contaminants. Elemental analyses of carbon and hydrogen by the analytical chemistry laboratory agreed with the theoretical values for nitromethane, but results for nitrogen were low. Karl Fischer water analysis indicated $0.086\% \pm 0.006\%$ water. Functional group titration indicated a purity of $97.8\% \pm 0.5\%$. Gas chromatography indicated three impurities with a combined area of 1.5% relative to the major peak by one system and three impurities with a combined

area of 1.9% relative to the major peak by the second system. Major peak comparison of lot 1-H-1004 with lot 1F 13 06 by gas chromatography indicated a purity of $100.3\% \pm 0.9\%$ for lot 1-H-1004 relative to lot 1F 13 06. The overall purity of lot 1-H-1004 was determined to be approximately 98%.

Accelerated stability studies of lots 1F 13 06 and 1-H-0501 of the bulk chemical were conducted with gas chromatography. Nitromethane was determined to be stable as a bulk chemical when stored in Teflon®-lined amber glass bottles, protected from light, for up to 2 weeks at temperatures up to 60° C. To ensure stability, the bulk chemical was stored in the original shipping containers (metal drums and amber glass bottles) at room temperature; lot 1F 13 06 was stored under a nitrogen headspace. Stability was monitored by the study laboratory throughout the studies with gas chromatography; no degradation of the bulk chemical was detected.

VAPOR GENERATION AND EXPOSURE SYSTEM

Nitromethane was held in a stainless-steel reservoir under a nitrogen blanket; a MasterFlex variable-speed peristaltic pump head (Cole-Parmer, Inc., Chicago, IL) was used to pump nitromethane through a liquid distribution manifold of stainless steel tubing to heated-wick vaporizers. During the 16-day studies, single vaporizers were used for each of the 750 and 1,500 ppm chambers, and a third vaporizer was located in the vapor distribution system that supplied the 94, 188, and 375 ppm chambers. During the 13-week and 2-year studies, one set of dual vaporizers supplied nitromethane vapor to all chambers. Detailed descriptions of the inhalation chambers and the vapor generation system are provided in Appendix J.

The vapor-laden air was transferred through the distribution line, where it was diluted with HEPA- and charcoal-filtered air, to the inhalation chambers; three-way valves mounted in the chamber inlet ducts allowed nitromethane vapors to be diverted to the exhaust until a stable concentration of nitromethane was built up in the distribution line. At each chamber, air moving through the chamber inlet duct was

further diluted with HEPA- and charcoal-filtered air to the appropriate nitromethane concentration for the chamber with a metered three-way valve. The study laboratory designed the inhalation exposure chamber (Harford Systems Division of Lab Products, Inc., Aberdeen, MD) so that uniform vapor concentrations could be maintained throughout the chamber with the catch pans in place. A small particle detector (Type CN, Gardner Associates, Schenectady, NY) was used with and without animals in the exposure chambers to ensure that nitromethane vapor, and not aerosol, was produced. No particle counts above the minimum resolvable level of approximately 200 particles/cm³ were detected.

VAPOR CONCENTRATION MONITORING

Chamber concentrations were monitored with an on-line gas chromatograph. The monitor was coupled with the inhalation chambers by a computer-controlled 12-port stream select valve. The gas chromatograph was calibrated by a comparison of chamber concentration data to data from grab samples analyzed by an off-line gas chromatograph; the grab samples were collected in bubblers containing dimethylformamide. The off-line gas chromatograph was calibrated with gravimetrically prepared nitromethane standards. Chamber concentration uniformity was maintained throughout the 16-day, 13-week, and 2-year studies. Summaries of the chamber concentrations for the 16-day, 13-week, and 2-year studies are presented in Tables J1 through J3. The monthly mean exposure concentrations for the 2-year study chambers are presented in Figures J7 through J12.

CHAMBER ATMOSPHERE CHARACTERIZATION

Buildup and decay rates for chamber concentrations were determined with and without animals present in the chambers. The time to achieve 90% of the target concentration after the beginning of vapor generation (T_{90}) ranged from 10 to 13 minutes during the 16-day studies and from 6 to 13 minutes during the 13-week studies. The time for the concentration in the chamber to decay to 10% of the target concentration after vapor generation ended (T_{10}) ranged from 11 to 14 minutes during the 16-day studies and from 11 to

15 minutes during the 13-week studies. During the 2-year studies, T_{90} ranged from 11 to 14 minutes without animals and from 5 to 17 minutes with animals in the chambers; T_{10} ranged from 13 to 16 minutes without animals and from 13 to 19 minutes with animals. A T_{90} value of 12 minutes was selected for all studies.

Studies of nitromethane degradation and monitoring for impurities were conducted throughout the studies by comparing bubbler samples to a reference sample of nitromethane. No significant degradation of nitromethane was observed during the studies.

16-DAY STUDIES

Male and female F344/N rats and B6C3F₁ mice were obtained from Simonsen Laboratories, Inc. (Gilroy, CA). On receipt, the rats and mice were 5 weeks old. Animals were quarantined for 12 days (rats) or 13 days (mice) and were 7 weeks old on the first day of the studies. Before the studies began, two male and two female rats and mice were randomly selected for parasite evaluation and gross observation for evidence of disease.

Groups of five male and five female rats and mice were exposed to 0, 94, 188, 375, 750, or 1,500 ppm nitromethane by inhalation, 6 hours plus T_{90} (12 minutes) per day, 5 days per week, for 16 days. Rats and mice received a total of 12 exposures, including two (rats) or three (mice) consecutive exposures before necropsy. Water was available *ad libitum*; feed was available *ad libitum* except during exposure periods. Rats and mice were housed individually. Clinical observations were recorded twice each day for rats and mice. The animals were weighed initially, on day 8, and at the end of the studies. Details of the study design and animal maintenance are summarized in Table 1.

At the end of the 16-day studies, a necropsy was performed on all rats and mice. The heart, right kidney, liver, lungs, right testis, thymus, and thyroid glands (rats only) were weighed. Histopathologic examinations were performed on all rats and mice. Following the 13-week studies, sections of the sciatic nerve of rats from the 16-day study were stained with Sevier-Munger Luxol Fast Blue to allow for evaluation of myelin around sciatic nerve axons. The

tissues and organs routinely examined are listed in Table 1.

13-WEEK STUDIES

The 13-week studies were conducted to evaluate the cumulative toxic effects of repeated exposure to nitromethane and to determine the appropriate exposure concentrations to be used in the 2-year studies.

Male and female F344/N rats and B6C3F₁ mice were obtained from Simonsen Laboratories (Gilroy, CA). On receipt, the rats and mice were 4 weeks old. Animals were quarantined for 13 or 14 days and were approximately 6 weeks old on the first day of the studies. Before the studies began, five male and five female rats and mice were randomly selected for parasite evaluation and gross observation for evidence of disease. Additionally, the kidneys of five male and five female mice were screened to ensure genetic integrity; the genetic profile of these mice was consistent with that of the B6C3F₁ strain. At the end of the study, serologic analyses were performed on five male and five female sentinel rats and control mice under the protocols of the NTP Sentinel Animal Program (Appendix L).

Groups of 10 male and 10 female rats and mice were exposed to 0, 94, 188, 375, 750, or 1,500 ppm nitromethane by inhalation, 6 hours plus T_{90} (12 minutes) per day, 5 days per week, for 13 weeks. Additional groups of 10 male and 10 female rats designated for clinical pathology evaluations received the same exposure concentrations as the core study rats. Water was available *ad libitum*; feed was available *ad libitum* except during exposure periods. Rats and mice were housed individually. Clinical observations were recorded weekly. The core study animals were weighed initially, weekly, and at the end of the studies. Details of the study design and animal maintenance are summarized in Table 1.

Neurobehavior tests including forelimb and hindlimb grip strength measurements, response to stimulus (tail flick latency), and startle response were performed on all male and female rats in the core study over a 2-day period during week 11. Rats were allowed to acclimate to the testing room for at least 2 hours. Forelimb and hindlimb grip strengths were measured

by allowing each rat to grip a triangular ring with its forepaws; the rat was pulled back along a channel until its forelimb grip was broken. While the backward motion continued, the rat was allowed to grasp a T-bar in the same channel with its hindpaws, then forced to release the bar by continued pulling. The strain required to break the forelimb and hindlimb grip was recorded with a calibrated push-pull strain gauge; for each animal, the means of three successive readings were determined for forelimb and hindlimb grip strength. Tail flick latency was measured with a Tail Flick Analgesiometer (Socrel, Varese, Italy), consisting of an infrared heat source (100 W) with radiant energy of adjustable intensity focused by a parabolic mirror on a photocell. Each rat was placed with its tail on the photocell window and a footpedal was depressed to activate the heat source and a timer; when the rat felt pain and flicked its tail, the photocell became energized, turning off the timer and the heat source. The reaction time was recorded as the time from heat onset to tail flick. Startle response to acoustic stimulation was measured with an SR Lab System (SRI, Scientific and Professional Support Group, La Jolla, CA); this system, which was located in an isolation chamber, measured the response of each rat to a series of six 40-millisecond bursts of 120 dB white noise, spaced 15 seconds apart, after the animal was acclimated to the system for 5 minutes. The maximum response amplitude and the time to reach the maximum response were measured.

Clinical pathology analyses were performed on rats designated for clinical pathology evaluation on days 3 and 23 and on core study rats at the end of the 13-week study. Rats were anesthetized and blood was withdrawn from the retroorbital plexus. Blood for hematology determinations was placed in collection tubes containing potassium EDTA as an anticoagulant. Blood for clinical chemistry evaluations was placed in tubes without anticoagulant and allowed to clot; these samples were then centrifuged and serum was removed. Erythrocyte and leukocyte counts, hematocrit, hemoglobin concentration, mean cell volume, mean cell hemoglobin, mean cell hemoglobin concentration, and platelet counts were measured on an Ortho ELT-8/ds Hematology Counter (Ortho Instruments, Westwood, MA). Differential leukocyte counts, morphologic evaluation of blood cells, and nucleated erythrocyte counts were

determined by light microscopic examination of blood films stained with Wright-Giemsa. Methemoglobin was measured within 30 minutes of blood collection with an IL co-oximeter (Instrumentation Laboratory, Inc., Lexington, MA). Clinical chemistry determinations were performed on an Abbott VP chemistry analyzer (Abbott Laboratories, Abbott Park, IL) with commercially available reagents. Serum triiodothyronine, thyroxine, free thyroxine, and thyroid-stimulating hormone concentrations were determined by ¹²⁵I radioimmunoassay techniques on a Packard Auto-Gamma counter (Packard Instrument Company, Downers Grove, IL). Reagents for triiodothyronine, thyroxine, and free thyroxine assays were obtained commercially; thyroid-stimulating hormone concentration measurements were performed with reference material obtained from the National Hormone and Pituitary Program. The hematology and clinical chemistry parameters measured are listed in Table 1.

At the end of the 13-week studies, samples were collected for sperm motility and vaginal cytology evaluations from all rats and mice in the 0, 375, 750, and 1,500 ppm groups. The parameters evaluated are listed in Table 1. Methods used were those described in the NTP's sperm motility and vaginal cytology evaluations protocol (NTP, 1987). For 7 consecutive days before the scheduled terminal sacrifice, the vaginal vaults of the females were moistened with saline, if necessary, and samples of vaginal fluid and cells were stained. Relative numbers of leukocytes, nucleated epithelial cells, and large squamous epithelial cells were determined and used to ascertain estrous cycle stage (i.e., diestrus, proestrus, estrus, and metestrus). Male animals were evaluated for sperm count and motility. The left epididymis and testis were isolated and weighed. The tail of the epididymis (cauda epididymis) was then removed from the epididymal body (corpus epididymis) and weighed. Test yolk (rats) or modified Tyrode's buffer (mice) was applied to slides, and a small incision was made at the distal border of the cauda epididymis. The sperm effluxing from the incision were dispersed in the buffer on the slides, and the numbers of motile and nonmotile spermatozoa were counted for five fields per slide by two observers. Following completion of sperm motility estimates, each left cauda epididymis was placed in buffered saline solution. Caudae were finely minced, and the tissue was incubated in the

saline solution and then heat fixed at 65° C. Sperm density was then determined microscopically with the aid of a hemacytometer. To quantify spermatogenesis, the testicular spermatid head count was determined by removing the tunica albuginea and homogenizing the left testis in phosphate-buffered saline containing 10% dimethyl sulfoxide. Homogenization-resistant spermatid nuclei were counted with a hemacytometer.

A necropsy was performed on all core study animals. The heart, right kidney, liver, lungs, right testis, thymus, and thyroid gland (rats only) were weighed. Tissues for microscopic examination were fixed and preserved in 10% neutral buffered formalin, processed and trimmed, embedded in paraffin, sectioned to a thickness of 5 to 6 μm , and stained with hematoxylin and eosin; additional sections of the spinal cord and sciatic nerve of rats were stained with Sevier-Munger Luxol Fast Blue to allow for a more complete evaluation of myelin around sciatic nerve axons. A complete histopathologic examination was performed on core study rats and mice in the 0 and 1,500 ppm groups. Additionally, all gross lesions and tissue masses and selected tissues of rats and mice in the lower exposure groups were examined. The tissues and organs examined are listed in Table 1.

2-YEAR STUDIES

Study Design

Groups of 50 male and 50 female rats and mice were exposed to nitromethane by inhalation, 6 hours plus T_{90} (12 minutes) per day, 5 days per week, for 103 weeks. Rats were exposed to 0, 94, 188, or 375 ppm. Mice were exposed to 0, 188, 375, or 750 ppm.

Source and Specification of Animals

Male and female F344/N rats and B6C3F₁ mice were obtained from Simonsen Laboratories, Inc. (Gilroy, CA) for use in the 2-year studies. Rats and mice were quarantined for 14 days before the studies began. Five male and five female rats and mice were selected for parasite evaluation and gross observation of disease. Additionally, the kidneys of five male and five female mice were screened to ensure genetic integrity; the genetic profile of these mice was consistent with that of the B6C3F₁ strain. Rats and

mice were approximately 6 weeks old at the beginning of the studies. The health of the animals was monitored during the studies according to the protocols of the NTP Sentinel Animal Program (Appendix L).

Animal Maintenance

Rats and mice were housed individually. Water was available *ad libitum*; feed was available *ad libitum* except during exposure periods. Cages were rotated within the inhalation chambers weekly. Further details of animal maintenance are given in Table 1. Information on feed composition and contaminants is provided in Appendix K.

Clinical Examinations and Pathology

All animals were observed twice daily. Clinical findings were recorded monthly through week 91, then every 2 weeks until the end of the studies. Animals were weighed at the beginning of the studies, weekly through week 12, monthly from week 15 through week 91, every 2 weeks thereafter, and at the end of the studies.

Complete necropsies and microscopic examinations were performed on all rats and mice. At necropsy, all organs and tissues were examined for grossly visible lesions, and all major tissues were fixed and preserved in 10% neutral buffered formalin, processed and trimmed, embedded in paraffin, sectioned to a thickness of 5 to 6 μm , and stained with hematoxylin and eosin for microscopic examination. For all paired organs (i.e., adrenal gland, kidney, ovary), samples from each organ were examined. Complete histopathologic examinations were performed on all animals. The sciatic nerves and spinal cords from approximately 15 male and 15 female rats in the 0 and 375 ppm groups were examined. For extended evaluation of renal tubule proliferative lesions in male rats, kidneys were step-sectioned at 1-mm intervals, and four additional sections were obtained from each kidney. The tissues and organs routinely examined are listed in Table 1.

Microscopic evaluations were completed by the study laboratory pathologist, and the pathology data were entered into the Toxicology Data Management System. The microscopic slides, paraffin blocks, and residual wet tissues were sent to the NTP Archives for inventory, slide/block match, and wet tissue

audit. The slides, individual animal data records, and pathology tables were evaluated by an independent quality assessment laboratory. The individual animal records and tables were compared for accuracy, the slide and tissue counts were verified, and the histotechnique was evaluated. For the 2-year studies, a quality assessment pathologist reviewed the lung, nasal cavity, and all neoplasms of all male and female rats; the kidney of all male rats; the mammary gland of all female rats; the sciatic nerve and spinal cord of approximately 15 male and 15 female rats in the 0 and 375 ppm groups; and the harderian gland, liver, lung, and nose and all neoplasms of all male and female mice.

The quality assessment report and the reviewed slides were submitted to the NTP Pathology Working Group (PWG) chairperson, who reviewed selected tissues and addressed any inconsistencies in the diagnoses made by the laboratory and quality assessment pathologists. Representative histopathology slides containing examples of lesions related to chemical administration, examples of disagreements in diagnoses between the laboratory and quality assessment pathologists, or lesions of general interest were presented by the chairperson to the PWG for review. The PWG consisted of the quality assessment pathologist and other pathologists experienced in rodent toxicologic pathology. This group examined the tissues without knowledge of dose groups or previously rendered diagnoses. When the PWG consensus differed from the opinion of the laboratory pathologist, the diagnosis was changed. Thus, the final diagnoses represent a consensus of quality assessment pathologists, the PWG chairperson, and the PWG. Details of these review procedures have been described, in part, by Maronpot and Boorman (1982) and Boorman *et al.* (1985). For subsequent analyses of the pathology data, the diagnosed lesions for each tissue type were evaluated separately or combined according to the guidelines of McConnell *et al.* (1986).

STATISTICAL METHODS

Survival Analyses

The probability of survival was estimated by the product-limit procedure of Kaplan and Meier (1958) and is presented in the form of graphs. Animals found dead of other than natural causes were

censored from the survival analyses; animals dying from natural causes were not censored. Statistical analyses for possible dose-related effects on survival used Cox's (1972) method for testing two groups for equality and Tarone's (1975) life table test to identify dose-related trends. All reported P values for the survival analyses are two sided.

Calculation of Incidence

The incidences of neoplasms or nonneoplastic lesions as presented in Tables A1, A4, B1, B5, C1, C5, D1, and D5 are given as the number of animals bearing such lesions at a specific anatomic site and the number of animals with that site examined microscopically. For calculation of statistical significance, the incidences of most neoplasms (Tables A3, B3, C3, and D3) and all nonneoplastic lesions are given as the numbers of animals affected at each site examined microscopically. However, when macroscopic examination was required to detect neoplasms in certain tissues (e.g., skin, intestine, harderian gland, and mammary gland) before microscopic evaluation, or when neoplasms had multiple potential sites of occurrence (e.g., leukemia or lymphoma), the denominators consist of the number of animals on which a necropsy was performed. Tables A3, B3, C3, and D3 also give the survival-adjusted neoplasm rate for each group and each site-specific neoplasm, i.e., the Kaplan-Meier estimate of the neoplasm incidence that would have been observed at the end of the study in the absence of mortality from all other competing risks (Kaplan and Meier, 1958).

Analysis of Neoplasm Incidences

The majority of neoplasms in these studies were considered to be incidental to the cause of death or not rapidly lethal. Thus, the primary statistical method used was logistic regression analysis, which assumed that the diagnosed neoplasms were discovered as the result of death from an unrelated cause and thus did not affect the risk of death. In this approach, neoplasm prevalence was modeled as a logistic function of chemical exposure and time. Both linear and quadratic terms in time were incorporated initially, and the quadratic term was eliminated if the fit of the model was not significantly enhanced. The neoplasm incidences of exposed and control groups were compared on the basis of the likelihood score test for the regression coefficient of dose. This method of adjusting for intercurrent mortality is the

prevalence analysis of Dinse and Lagakos (1983), further described and illustrated by Dinse and Haseman (1986). When neoplasms are incidental, this comparison of the time-specific neoplasm prevalences also provides a comparison of the time-specific neoplasm incidences (McKnight and Crowley, 1984).

In addition to logistic regression, other methods of statistical analysis were used, and the results of these tests are summarized in the appendixes. These methods include the life table test (Cox, 1972; Tarone, 1975), appropriate for rapidly lethal neoplasms, and the Fisher exact test and the Cochran-Armitage trend test (Armitage, 1971; Gart *et al.*, 1979), procedures based on the overall proportion of neoplasm-bearing animals.

Tests of significance included pairwise comparisons of each exposed group with controls and a test for an overall dose-related trend. Continuity-corrected tests were used in the analysis of neoplasm incidence, and reported P values are one sided. For further discussion of these statistical methods, refer to Haseman (1984).

Using individual animal data from more than 3,000 rats and mice in the NTP historical control database, Seilkop (1995) demonstrated that certain site-specific neoplasms are strongly correlated with body weight. Seilkop also developed a logistic regression model that accurately predicted the control incidence of these neoplasms based on survival and 52-week body weights. The Seilkop model was used in these studies to evaluate the possible impact of survival and body weight differences on the incidence of mammary gland neoplasms in female F344/N rats and liver neoplasms in B6C3F₁ mice, the neoplasms having the strongest correlation with body weights.

Analysis of Nonneoplastic Lesion Incidences
Because all nonneoplastic lesions in this study were considered to be incidental to the cause of death or not rapidly lethal, the primary statistical analysis used was a logistic regression analysis in which nonneoplastic lesion prevalence was modeled as a logistic function of chemical exposure and time.

Analysis of Continuous Variables

Two approaches were employed to assess the significance of pairwise comparisons between exposed and

control groups in the analysis of continuous variables. Organ and body weight and neurobehavior data, which have approximately normal distributions, were analyzed with the parametric multiple comparison procedures of Dunnett (1955) and Williams (1971, 1972). Hematology, clinical chemistry, spermatid, and epididymal spermatozoal data, which have typically skewed distributions, were analyzed with the nonparametric multiple comparison methods of Shirley (1977) and Dunn (1964). Jonckheere's test (Jonckheere, 1954) was used to assess the significance of the dose-related trends and to determine whether a trend-sensitive test (Williams' or Shirley's test) was more appropriate for pairwise comparisons than a test that does not assume a monotonic dose-related trend (Dunnett's or Dunn's test). Prior to statistical analysis, extreme values identified by the outlier test of Dixon and Massey (1951) were examined by NTP personnel, and implausible values were eliminated from the analysis. Average severity values were analyzed for significance with the Mann-Whitney U test (Hollander and Wolfe, 1973). Because the vaginal cytology data are proportions (the proportion of the observation period that an animal was in a given estrous stage), an arcsine transformation was used to bring the data into closer conformance with a normality assumption. Treatment effects were investigated by applying a multivariate analysis of variance (Morrison, 1976) to the transformed data to test for simultaneous equality of measurements across exposure levels.

Historical Control Data

Although the concurrent control group is always the first and most appropriate control group used for evaluation, historical control data can be helpful in the overall assessment of neoplasm incidence in certain instances. Consequently, neoplasm incidences from the NTP historical control database, which is updated yearly, are included in the NTP reports for neoplasms appearing to show compound-related effects.

QUALITY ASSURANCE METHODS

The 13-week and 2-year studies were conducted in compliance with Food and Drug Administration Good Laboratory Practice Regulations (21 CFR, Part 58). In addition, as records from the 2-year studies were submitted to the NTP Archives, these studies were

audited retrospectively by an independent quality assurance contractor. Separate audits covering completeness and accuracy of the pathology data, pathology specimens, final pathology tables, and a draft of this NTP Technical Report were conducted. Audit procedures and findings are presented in the reports and are on file at NIEHS. The audit findings were reviewed and assessed by NTP staff, so all comments had been resolved or were otherwise addressed during the preparation of this Technical Report.

GENETIC TOXICOLOGY

The genetic toxicity of nitromethane was assessed by testing the ability of the chemical to induce mutations in various strains of *Salmonella typhimurium*, sister chromatid exchanges and chromosomal aberrations in cultured Chinese hamster ovary cells, and increases in the frequency of micronucleated erythrocytes in mouse peripheral blood. The protocols for these studies and the results are given in Appendix E.

The genetic toxicity studies of nitromethane are part of a larger effort by the NTP to develop a database that would permit the evaluation of carcinogenicity in experimental animals from the structure and responses of the chemical in short-term *in vitro* and *in vivo* genetic toxicity tests. These genetic toxicity tests were originally developed to study mechanisms

of chemically induced DNA damage and to predict carcinogenicity in animals, based on the electrophilic theory of chemical carcinogenesis and the somatic mutation theory (Miller and Miller, 1977; Straus, 1981; Crawford, 1985).

There is a strong correlation between a chemical's potential electrophilicity (structural alert to DNA reactivity), mutagenicity in *Salmonella*, and carcinogenicity in rodents. The combination of electrophilicity and *Salmonella* mutagenicity is highly correlated with the induction of carcinogenicity in rats and mice and/or at multiple tissue sites (Ashby and Tennant, 1991). Other *in vitro* genetic toxicity tests do not correlate well with rodent carcinogenicity (Tennant *et al.*, 1987; Zeiger *et al.*, 1990), although these other tests can provide information on the types of DNA and chromosome effects that can be induced by the chemical being investigated. Data from NTP studies show that a positive response in *Salmonella* is currently the most predictive *in vitro* test for rodent carcinogenicity (89% of the *Salmonella* mutagens were rodent carcinogens), and that there is no complementarity among the *in vitro* genetic toxicity tests. That is, no battery of tests that included the *Salmonella* test improved the predictivity of the *Salmonella* test alone. The predictivity for carcinogenicity of a positive response in bone marrow chromosome aberration or micronucleus tests is not yet defined.

TABLE 1
Experimental Design and Materials and Methods in the Inhalation Studies of Nitromethane

16-Day Studies	13-Week Studies	2-Year Studies
Study Laboratory Battelle Pacific Northwest Laboratories (Richland, WA)	Battelle Pacific Northwest Laboratories (Richland, WA)	Battelle Pacific Northwest Laboratories (Richland, WA)
Strain and Species Rats: F344/N Mice: B6C3F ₁	Rats: F344/N Mice: B6C3F ₁	Rats: F344/N Mice: B6C3F ₁
Animal Source Simonsen Laboratories, Inc. (Gilroy, CA)	Simonsen Laboratories, Inc. (Gilroy, CA)	Simonsen Laboratories, Inc. (Gilroy, CA)
Time Held Before Studies Rats: 12 days Mice: 13 days	Rats: 13 (male) or 14 days (female) Mice: 14 days	14 days
Average Age When Studies Began 7 weeks	6 weeks	7 weeks
Date of First Dose Rats: 14 March 1988 Mice: 15 March 1988	Rats: 5 (male) or 6 (female) July 1988 Mice: 6 July 1988	Rats: 7 September 1989 Mice: 31 August 1989
Duration of Dosing 6 hours plus T ₉₀ (12 minutes) per day, 5 days per week, for 16 days	6 hours plus T ₉₀ (12 minutes) per day, 5 days per week, for 13 weeks	6 hours plus T ₉₀ (12 minutes) per day, 5 days per week, for 103 weeks
Date of Last Dose Rats: 29 March 1988 Mice: 30 March 1988	Rats: 3 (male) or 4 (female) October 1988 Mice: 5 (male) or 6 (female) October 1988	Rats: 28 August 1991 Mice: 21 August 1991
Necropsy Dates Rats: 30 March 1988 Mice: 31 March 1988	Rats: 4 (male) or 5 (female) October 1988 Mice: 6 (male) or 7 (female) October 1988	Rats: 9-11 September 1991 Mice: 3-6 September 1991
Average Age at Necropsy 9 weeks	Rats: 19 weeks Mice: 19 (male) or 20 weeks (female)	Rats: 111 weeks Mice: 111-112 weeks
Size of Study Groups 5 males and 5 females	10 males and 10 females	50 males and 50 females
Method of Distribution Animals were distributed randomly into groups of approximately equal initial mean body weight.	Same as 16-day studies	Same as 16-day studies

TABLE 1
Experimental Design and Materials and Methods in the Inhalation Studies of Nitromethane (continued)

16-Day Studies	13-Week Studies	2-Year Studies
Animals per Cage 1	1	1
Method of Animal Identification Rats: tail tattoo Mice: toe clip	Tail tattoo	Tail tattoo
Diet NIH-07 open formula pelleted diet (Zeigler Brothers, Inc., Gardners, PA), available <i>ad libitum</i> except during exposure periods, changed weekly	Same as 16-day studies	Same as 16-day studies
Water Distribution Softened tap water (City of Richland municipal supply) via automatic watering system (Systems Engineering, Napa, CA), available <i>ad libitum</i>	Softened tap water (City of Richland municipal supply) via automatic watering system (Edstrom Industries, Waterford, WI), available <i>ad libitum</i>	Same as 16-day studies
Cages Stainless steel wire-bottom cages (Lab Products, Inc., Harford Systems, Aberdeen, MD); changed weekly and rotated in chamber daily	Same as 16-day studies, but rotated in chamber weekly	Stainless steel wire-bottom cages (Lab Products, Inc., Maywood, NJ); changed and rotated in chamber weekly
Chambers Stainless steel chambers (Lab Products Inc., Harford Systems, Aberdeen, MD), changed weekly	Same as 16-day studies	Same as 16-day studies
Chamber Filters Single HEPA (Flanders Filters, Inc., San Rafael, CA) and charcoal (RSE, Inc., New Baltimore, MI)	Same as 16-day studies	Same as 16-day studies
Chamber Environment Mean temperature: 22.5° to 24.2° C Mean relative humidity: 51% to 55% Room fluorescent light: 12 hours/day Chamber air: 14.5 to 15.9 ft ³ /minute	Mean temperature: 23.2° to 24.1° C Mean relative humidity: 55% to 57% Room fluorescent light: 12 hours/day Chamber air: 14.4 to 14.6 ft ³ /minute	Mean temperature: 23.9° to 24.3° C (rats), 23.5° to 23.9° C (mice) Mean relative humidity: 55% to 57% (rats), 54% to 56% (mice) Room fluorescent light: 12 hours/day Chamber air: 15.1 to 15.6 ft ³ /minute (rats), 14.6 to 14.7 ft ³ /minute (mice)
Exposure Concentrations 0, 94, 188, 375, 750, or 1,500 ppm	0, 94, 188, 375, 750, or 1,500 ppm	Rats: 0, 94, 188, or 375 ppm Mice: 0, 188, 375, or 750 ppm

TABLE 1
Experimental Design and Materials and Methods in the Inhalation Studies of Nitromethane (continued)

16-Day Studies	13-Week Studies	2-Year Studies
<p>Type and Frequency of Observation Observed and clinical observations recorded twice daily; animals were weighed initially, on day 8, and at the end of the studies.</p>	<p>Observed twice daily; animals were weighed initially, weekly, and at the end of the studies; clinical observations were recorded weekly.</p>	<p>Observed twice daily; clinical observations were recorded monthly through week 91, then every 2 weeks until the end of the studies. Animals were weighed initially, weekly through week 12, monthly from week 15 through week 91, every 2 weeks thereafter, and at the end of the studies.</p>
<p>Method of Sacrifice Asphyxiation with 70% CO₂</p>	<p>Asphyxiation with 70% CO₂</p>	<p>Asphyxiation with 70% CO₂</p>
<p>Necropsy Necropsy performed on all animals. Organs weighed were heart, right kidney, liver, lungs, right testis, thymus, and thyroid glands (rats only).</p>	<p>Necropsy performed on all core study animals. Organs weighed were heart, right kidney, liver, lungs, right testis, thymus, and thyroid glands (rats only).</p>	<p>Necropsy performed on all animals.</p>
<p>Clinical Pathology None</p>	<p>Blood was collected from all clinical pathology group rats on days 3 and 23 and from all core study rats at the end of the study for hematology and clinical chemistry. Blood was collected from the retroorbital plexus of animals anesthetized with 70% CO₂ after 2 or 3 consecutive days of exposure. Hematology: hematocrit, hemoglobin concentration, erythrocyte counts, nucleated erythrocyte counts, mean cell volume, mean cell hemoglobin, mean cell hemoglobin concentration, platelet counts, total leukocyte count and differentials, and methemoglobin concentration Clinical chemistry: urea nitrogen, creatinine, total protein, albumin, and globulin concentrations; alanine aminotransferase, alkaline phosphatase, creatine kinase, and sorbitol dehydrogenase activities; bile acid, thyroid-stimulating hormone, triiodothyronine, and total and free thyroxine concentrations</p>	<p>None</p>

TABLE 1
Experimental Design and Materials and Methods in the Inhalation Studies of Nitromethane (continued)

16-Day Studies	13-Week Studies	2-Year Studies
<p>Histopathology Histopathology was performed on all rats and mice. In addition to gross lesions and tissue masses, the tissues examined included: brain, larynx, lung and attached tracheobronchial lymph nodes, nose, sciatic nerve (rats), and trachea (longitudinal and transverse sections).</p>	<p>Complete histopathology was performed on core study rats and mice in the 0 and 1,500 ppm groups. In addition to gross lesions and tissue masses, the tissues examined included: adrenal gland, bone and marrow, brain, clitoral gland, epididymis, esophagus, eyes (if grossly abnormal), gallbladder (mice), heart, kidney, large intestine (cecum, colon, and rectum), larynx, liver, lung, lymph nodes (bronchial, mandibular, mediastinal, and mesenteric), mammary gland, nose, ovary, pancreas, parathyroid gland, pharynx (if grossly abnormal), pituitary gland, preputial gland, prostate gland, salivary gland, seminal vesicle, skin, small intestine (duodenum, jejunum, and ileum), spinal cord and sciatic nerve (rats), spleen, stomach (forestomach and glandular stomach), testis, thigh muscle, thymus, thyroid gland, trachea, urinary bladder, uterus, and vagina (females in vaginal cytology studies only). Additionally, the bone marrow, lung, and nose of male and female rats; cecum, larynx, and testis of male rats; and the nose and spleen of male and female mice in the 94, 188, 375, and 750 ppm groups were examined until a no-effect level was reached.</p>	<p>Complete histopathology was performed on all rats and mice. In addition to gross lesions and tissue masses, the tissues examined included: adrenal gland, bone and marrow, brain, clitoral gland, epididymis, esophagus, gallbladder (mice), harderian gland (mice), heart, kidney, large intestine (cecum, colon, and rectum), larynx, liver, lung, lymph nodes (bronchial, mandibular, mediastinal, and mesenteric), mammary gland, nose, ovary, pancreas, parathyroid gland, pituitary gland, preputial gland, prostate gland, salivary gland, seminal vesicle, skin, small intestine (duodenum, jejunum, and ileum), spinal cord and sciatic nerve (a limited review of male and female rats in the 0 and 375 ppm groups), spleen, stomach (forestomach and glandular stomach), testis, thymus, thyroid gland, trachea, urinary bladder, and uterus.</p>
<p>Sperm Motility and Vaginal Cytology Evaluations None</p>	<p>Rats and mice in the 0, 375, 750, and 1,500 ppm groups were evaluated. Sperm samples were collected at the end of the studies and evaluated for sperm count and motility. The left cauda, epididymis, and testis were weighed. Vaginal samples were collected for 7 consecutive days before the end of the studies and evaluated for the relative frequency of estrous stages and for estrous cycle length.</p>	<p>None</p>
<p>Neurobehavioral Evaluations None</p>	<p>Neurobehavior testing was performed on core study rats over a 2-day period during week 11 of the study. Parameters measured included forelimb and hindlimb grip strength, tail flick latency, and startle response.</p>	<p>None</p>

RESULTS

RATS

16-DAY STUDY

All rats survived until the end of the study (Table 2). The mean body weight gain of male rats in the 1,500 ppm group was slightly but significantly less than that of the controls; the final mean body weights and mean body weight gains of exposed females were similar to those of the controls. Clinical findings of toxicity were observed in all male and female rats in the 1,500 ppm groups and included increased preening, rapid breathing, hyperactivity early in the study, and hypoactivity and loss of coordination in the hindlimbs near the end of the study.

The relative liver weights of all exposed groups of male rats and the absolute and relative liver weights of females exposed to 375 ppm or greater were significantly greater than those of the controls (Table F1). The relative kidney weights of male rats in the 750 and 1,500 ppm groups and female rats in the 1,500 ppm group were significantly greater than those of the controls; other differences in organ weights between exposed and control rats were secondary to body weight changes. Absolute and relative lung weights of exposed rats were similar to those of the controls.

TABLE 2
Survival and Body Weights of Rats in the 16-Day Inhalation Study of Nitromethane

Concentration (ppm)	Survival ^a	Mean Body Weight ^b (g)			Final Weight Relative to Controls (%)
		Initial	Final	Change	
Male					
0	5/5	145 ± 4	182 ± 4	38 ± 2	
94	5/5	147 ± 4	189 ± 5	43 ± 2	104
188	5/5	146 ± 4	187 ± 5	41 ± 2	103
375	5/5	145 ± 3	182 ± 6	37 ± 3	100
750	5/5	144 ± 3	177 ± 4	34 ± 1	97
1,500	5/5	146 ± 3	171 ± 4	25 ± 3**	94
Female					
0	5/5	116 ± 2	134 ± 3	17 ± 1	
94	5/5	116 ± 2	135 ± 3	18 ± 3	101
188	5/5	116 ± 2	133 ± 2	17 ± 1	99
375	5/5	116 ± 2	133 ± 2	18 ± 2	100
750	5/5	117 ± 2	132 ± 1	15 ± 2	99
1,500	5/5	117 ± 2	128 ± 2	11 ± 1	96

** Significantly different ($P \leq 0.01$) from the control group by Williams' or Dunnett's test

^a Number of animals surviving at 16 days/number initially in group

^b Weights and weight changes are given as mean ± standard error.

All males exposed to 375 ppm or greater, all females in the 750 and 1,500 ppm groups, and four females in the 375 ppm group had degeneration of the olfactory epithelium of the nasal turbinates; this lesion was of minimal to mild severity in exposed males and females (Table 3). There were no exposure-related lesions in the lungs of exposed male or female rats.

During the 16-day study, neurobehavioral effects were not sufficient to warrant evaluation of nervous system tissues. However, because of the hindlimb paralysis and histopathologic effects on the sciatic nerve in the 13-week study, the sciatic nerves from rats in the 16-day study were subsequently evaluated histopathologically. Sciatic nerve degeneration was present in all male and female rats exposed to 375 ppm or greater (Table 3). This lesion was characterized by prominent, diffuse vacuolization and

dilatation of the axonal sheaths and increased cellularity, which was apparently due to Schwann cell hyperplasia. The severity of these lesions increased with increasing exposure concentration and ranged from minimal to moderate. Rats exposed to 750 or 1,500 ppm had significantly less myelin around the sciatic axons than did the controls.

Exposure Concentration Selection Rationale: Due to the lack of significant toxicologic or histopathologic effects, including the absence of histopathologic effects in the lung, nitromethane exposure concentrations selected for use in the 13-week study were the same as for the 16-day study. The sciatic nerve degeneration in rats in the 16-day study was not discovered until after the conclusion of the 13-week study.

TABLE 3
Incidences of Selected Nonneoplastic Lesions in Rats in the 16-Day Inhalation Study of Nitromethane

	0 ppm	94 ppm	188 ppm	375 ppm	750 ppm	1,500 ppm
Male						
Nose/Turbinates ^a	5	5	5	5	5	5
Degeneration, Olfactory Epithelium ^b	0	0	0	5** (1.0) ^c	5** (2.0)	5** (2.0)
Sciatic Nerve	4	5	5	5	5	5
Degeneration	0	0	0	5** (1.0)	5** (2.0)	5** (3.0)
Female						
Nose/Turbinates						
Degeneration, Olfactory Epithelium	5	5	5	5	5	5
	0	0	0	4* (1.0)	5** (1.8)	5** (2.0)
Sciatic Nerve	5	5	5	5	5	5
Degeneration	0	0	0	5** (1.0)	5** (2.0)	5** (3.0)

* Significantly different ($P \leq 0.05$) from the control group by the Fisher exact test

** $P \leq 0.01$

^a Number of animals with tissue examined microscopically

^b Number of animals with lesion

^c Average severity of lesions in affected rats: 1 = minimal, 2 = mild, 3 = moderate, 4 = marked

13-WEEK STUDY

All rats survived to the end of the study (Table 4). The final mean body weight and weight gain of male rats in the 1,500 ppm group were significantly less than those of the controls. Clinical findings included hindlimb paralysis in all male and female rats in the 1,500 ppm groups, beginning on day 21, and one male and four females in the 750 ppm groups, beginning on day 63.

Hematology and clinical chemistry data are provided in Table G1. Exposure to nitromethane caused an exposure concentration-dependent, microcytic, responsive anemia in rats. The anemia was characterized by mild to moderate decreases in hematocrit values and hemoglobin concentrations, and the microcytosis was evidenced by minimal to moderate decreases in mean cell volume. Hematocrit values

and hemoglobin concentrations were less than those of the controls for male and female rats in the 375, 750, and 1,500 ppm groups at all time points and in the 94 and 188 ppm groups at various time points. Additionally, erythrocyte counts on day 3 were minimally to mildly decreased in males exposed to 188 ppm or greater and females exposed to 750 or 1,500 ppm compared those of the controls; this finding is consistent with anemia. The decreases in mean cell volume occurred in all groups of exposed females at all time points and in all groups of exposed males at the end of the study; decreased mean cell volumes indicate increased numbers of smaller erythrocytes in the circulation. Review of erythrocyte size distribution information on day 23 revealed that two distinct populations of erythrocytes were present in rats in the higher exposure groups; one of these populations consisted of smaller

TABLE 4
Survival and Body Weights of Rats in the 13-Week Inhalation Study of Nitromethane

Concentration (ppm)	Survival ^a	Mean Body Weight ^b (g)			Final Weight Relative to Controls (%)
		Initial	Final	Change	
Male					
0	10/10	107 ± 3	334 ± 7	228 ± 6	
94	10/10	105 ± 2	323 ± 7	218 ± 7	97
188	10/10	113 ± 2	345 ± 4	232 ± 3	103
375	10/10	109 ± 3	336 ± 5	227 ± 4	101
750	10/10	106 ± 2	327 ± 4	221 ± 5	98
1,500	10/10	109 ± 2	295 ± 10**	185 ± 9**	88
Female					
0	10/10	95 ± 1	185 ± 5	90 ± 3	
94	10/10	96 ± 2	197 ± 3	101 ± 2	107
188	10/10	97 ± 2	197 ± 3	100 ± 2	106
375	10/10	95 ± 2	198 ± 5	103 ± 4**	107
750	10/10	96 ± 2	194 ± 4	97 ± 2	105
1,500	10/10	94 ± 2	177 ± 4	84 ± 3	96

** Significantly different ($P \leq 0.01$) from the control group by Williams' or Dunnett's test

^a Number of animals surviving at 13 weeks/number initially in group

^b Weights and weight changes are given as mean ± standard error.

erythrocytes. Additionally, microcytosis was observed in the blood smears of exposed rats; microcytosis is consistent with the decreased mean cell volume. At all time points, mean cell hemoglobin values of exposed rats were decreased compared to those of the controls; these decreases were attributed to the smaller erythrocyte sizes. The mean cell hemoglobin concentrations of males exposed to 750 or 1,500 ppm and females exposed to 1,500 ppm were minimally greater than those of the controls at all time points. Increases in mean cell hemoglobin concentration have been related to erythrocyte hemolysis (*in vivo* or *in vitro*). On day 23 and at week 13, a hematopoietic response was evidenced by increased numbers of nucleated erythrocytes in exposed animals compared to the controls.

Exposure concentration-dependent alterations in erythrocyte morphology occurred at all time points. On day 3, minimal numbers of Heinz bodies were observed in male rats in the 750 and 1,500 ppm groups; other red blood cell changes were present in males and females in the higher exposure groups on day 23 and at week 13. Morphologic alterations of red blood cells included anisocytosis (e.g., microcytes and spherocytes), poikilocytosis (e.g., schistocytes and acanthocytes), polychromasia, and target cells. The presence of Heinz bodies would be consistent with oxidative red blood cell damage. Schistocytes are irregular erythrocyte fragments that usually result from trauma to red blood cells; the presence of these would suggest a hemolytic process. Spherocytes have been observed in conjunction with immune-mediated and Heinz body anemias. Polychromasia would be consistent with the presence of young erythrocytes (reticulocytes) and would indicate a bone marrow response to the anemia.

Minimal, exposure concentration-dependent increases in methemoglobin concentration occurred in male and female rats, indicating oxidative red cell injury. Male rats exposed to 375 ppm or greater had minimally increased methemoglobin concentrations compared to the controls at all time points. Methemoglobin concentrations were also minimally increased in females in the 750 and 1,500 ppm groups compared to the controls on day 23 and at 13 weeks.

Platelet counts in all groups of exposed rats were mildly to markedly increased compared to the controls at all time points. A review of platelet size distribution information on day 23 revealed a wide size-distribution curve and indicated the presence of significant numbers of large platelets or particles counted as platelets. Increased platelet counts may be consistent with a reactive thrombocytosis, which can be caused by a variety of conditions, including bone marrow response to anemia. In light of the evidence suggestive of a hemolytic process (e.g., schistocytes, Heinz bodies, and increased mean cell hemoglobin concentration and methemoglobin concentration), the erroneous inclusion of small erythrocyte fragments in the platelet count could, in part, account for the platelet count increases.

On day 23, a hypothyroid state, evidenced by decreased serum triiodothyronine, thyroxine, and free thyroxine, occurred in males exposed to 375 ppm or greater and females exposed to 750 or 1,500 ppm; thyroxine concentrations of female rats in the 188 and 375 ppm groups were also decreased. There was little or no pituitary response to the thyroid hormone decreases, as evidenced by the lack of significantly increased thyroid-stimulating hormone concentrations in exposed rats. The change in thyroid hormone concentrations was transient, and at 13 weeks, hormone concentrations of exposed rats were similar to those of the controls. Differences in other hematology and clinical chemistry variables were not related to exposure and were not considered biologically significant.

No biologically significant differences in organ weights between exposed and control rats were observed (Table F2). The forelimb and hindlimb grip strengths of males in the 1,500 ppm group were significantly less than those of the controls (Table I1). The hindlimb grip strengths of females in the 750 and 1,500 ppm groups were also significantly less than the control value.

Male rats in the 750 and 1,500 ppm groups had significantly lower epididymal spermatozoal motility than the controls; the left cauda, epididymis, and testis weights of males in the 1,500 ppm group were also significantly less than those of the controls (Table H1). There were no biologically significant differences in the length of the estrous cycle or in the

relative amounts of time spent in the various estrous stages between exposed and control females.

At necropsy, no gross lesions were observed that were considered related to nitromethane exposure. Minimal to mild hyperplasia of the bone marrow was observed microscopically in male rats in the 750 and 1,500 ppm groups and in females exposed to 188 ppm or greater (Table 5). Olfactory epithelial degeneration was observed in males and females exposed to 375 ppm or greater and in one female in the 188 ppm group. Respiratory epithelial hyaline droplets and goblet cell hyperplasia were observed in males and females in the 750 and 1,500 ppm groups (Table 5); the severity of nasal lesions in exposed males and females ranged from minimal to mild.

Males and females exposed to 375 ppm or greater had minimal to mild degeneration of the spinal cord and sciatic nerve (Table 5). Sciatic nerve degeneration, as observed in the 16-day study, was observed in most rats exposed to 375 ppm and in all rats exposed to 750 or 1,500 ppm; however, the degeneration in exposed rats in the 13-week study was less

severe than that observed in the 16-day study. In rats exposed to 1,500 ppm, the lesion was considered mild and was characterized by focal dilatation, with foci containing eosinophilic debris, and vacuolization of the axonal sheaths. Increased cellularity, presumably due to Schwann cell hyperplasia, was apparent, primarily in rats exposed to 1,500 ppm. The presence of inflammatory cells and myelin debris was less prevalent than in the 16-day study. Minimal to mild degeneration of the lumbar spinal cord was present in some rats exposed to 375 ppm and in all rats exposed to 750 or 1,500 ppm. This lesion was characterized by focal vacuolization in the white matter of the lumbar region of the cord and, to a greater extent, in the spinal nerves. The foci contained eosinophilic, granular debris.

Exposure Concentration Selection Rationale: Due to the increased incidences and severity of degeneration of the sciatic nerve and spinal cord in rats exposed to 750 or 1,500 ppm and to the rather minimal changes in the 375 ppm groups, nitromethane exposure concentrations selected for the 2-year study in rats were 94, 188, and 375 ppm.

TABLE 5
Incidences of Selected Nonneoplastic Lesions in Rats in the 13-Week Inhalation Study of Nitromethane

	0 ppm	94 ppm	188 ppm	375 ppm	750 ppm	1,500 ppm
Male						
Bone Marrow ^a	10	10	10	10	10	10
Hyperplasia ^b	0	0	0	0	9** (1.1) ^c	10** (2.0)
Nose/Turbinates	10	— ^d	10	10	10	10
Degeneration, Olfactory Epithelium	0		0	9** (1.0)	10** (1.0)	10** (1.0)
Hyaline Droplets, Respiratory Epithelium	0		0	0	1 (1.0)	8** (1.0)
Hyperplasia, Goblet Cell	0		0	0	1 (1.0)	10** (2.0)
Sciatic Nerve	10	—	10	10	10	10
Degeneration	0		0	5* (1.0)	10** (1.2)	10** (1.5)
Spinal Cord	10	—	10	10	10	10
Degeneration	0		0	9** (1.0)	10** (1.4)	10** (2.0)
Female						
Bone Marrow	10	10	10	10	10	10
Hyperplasia	0	0	1 (2.0)	6** (1.0)	7** (1.1)	10** (1.7)
Nose/Turbinates	10	10	10	10	10	10
Degeneration, Olfactory Epithelium	0	0	1 (1.0)	10** (1.0)	10** (1.2)	10** (1.8)
Hyaline Droplets, Respiratory Epithelium	0	0	0	0	4* (1.0)	10** (1.0)
Hyperplasia, Goblet Cell	0	0	0	0	2 (1.5)	10** (1.7)
Sciatic Nerve	10	—	10	10	10	10
Degeneration	0		0	8** (1.0)	10** (1.1)	10** (1.8)
Spinal Cord	10	—	10	10	10	10
Degeneration	0		0	2 (1.0)	10** (1.4)	10** (1.9)

* Significantly different ($P \leq 0.05$) from the control group by the Fisher exact test

** $P \leq 0.01$

^a Number of animals with tissue examined microscopically

^b Number of animals with lesion

^c Average severity of lesions in affected rats: 1 = minimal, 2 = mild, 3 = moderate, 4 = marked

^d Not examined at this exposure concentration

2-YEAR STUDY

Survival

Estimates of 2-year survival probabilities for male and female rats are shown in Table 6 and in the Kaplan-Meier survival curves (Figure 1). There were no significant differences in survival rates between exposed and control male or female rats.

Body Weights and Clinical Findings

Mean body weights are given in Figure 2 and Tables 7 and 8. From week 23 to the end of the

study, the mean body weight of females in the 375 ppm group was slightly greater than that of the control group. The mean body weights of exposed males were generally similar to the mean body weight of the controls throughout the study. Clinical findings (masses on shoulder and torso) consistent with mammary gland neoplasms were observed in females in the 188 and 375 ppm groups during the course of the study; there were no indications of hindlimb paralysis, as observed in the 13-week study, or other treatment-related clinical findings during the study.

TABLE 6
Survival of Rats in the 2-Year Inhalation Study of Nitromethane

	0 ppm	94 ppm	188 ppm	375 ppm
Male				
Animals initially in study	50	50	50	50
Moribund	33	31	34	39
Natural deaths	4	3	2	3
Animals surviving to study termination	13	16	14	8
Percent probability of survival at end of study ^a	26	32	28	16
Mean survival (days) ^b	642	631	646	640
Survival analysis ^c	P=0.378	P=1.000N	P=1.000N	P=0.361
Female				
Animals initially in study	50	50	50	50
Moribund	17	26	18	25
Natural deaths	5	5	2	2
Animals surviving to study termination	28	19	30	23
Percent probability of survival at end of study	56	38	60	46
Mean survival (days)	683	653	679	670
Survival analysis	P=0.780	P=0.083	P=0.900N	P=0.404

^a Kaplan-Meier determinations

^b Mean of all deaths (uncensored, censored, and terminal sacrifice)

^c The result of the life table trend test (Tarone, 1975) is in the control column, and the results of the life table pairwise comparisons (Cox, 1972) with the controls are in the exposed group columns. A lower mortality in an exposed group is indicated by N.

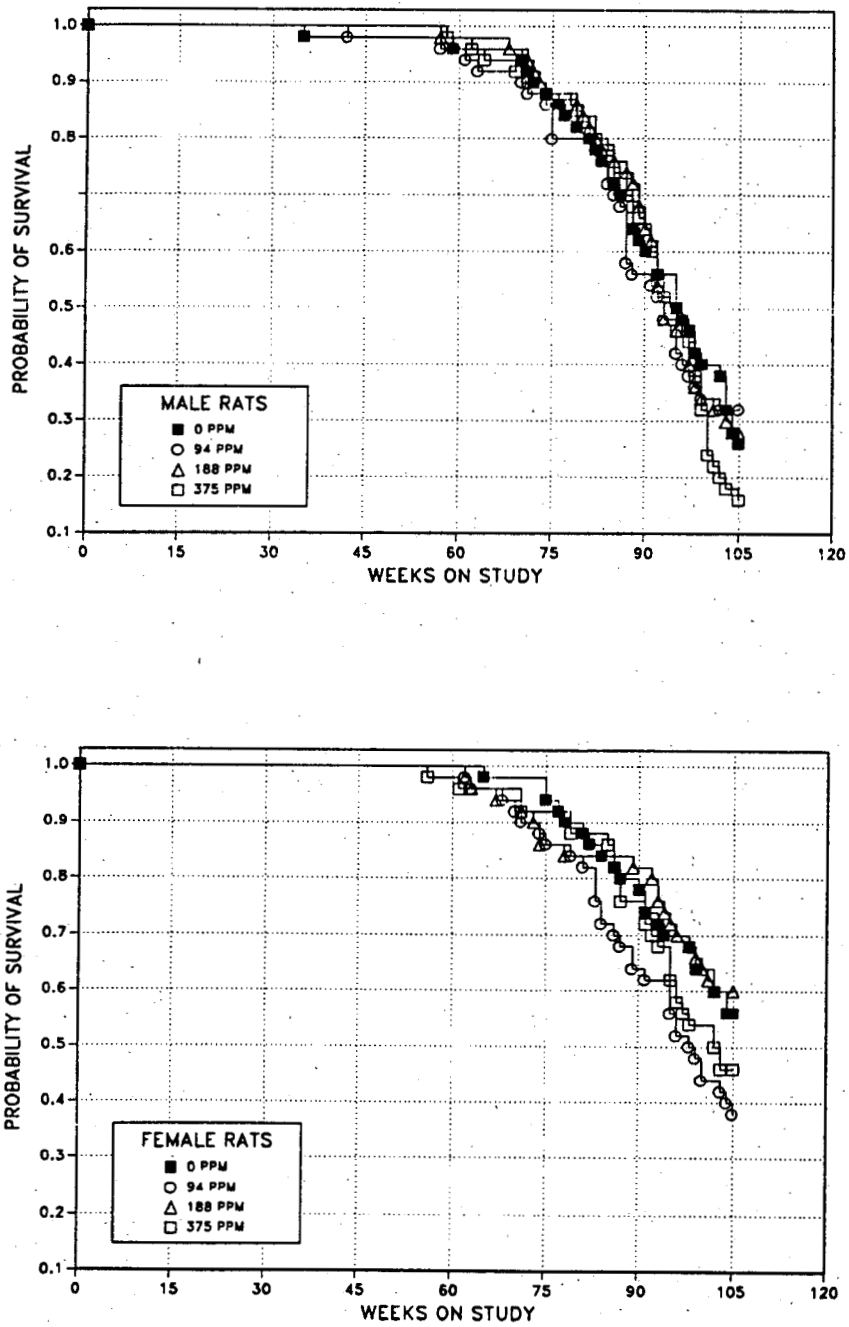

FIGURE 1
Kaplan-Meier Survival Curves for Male and Female Rats Exposed to Nitromethane by Inhalation for 2 Years

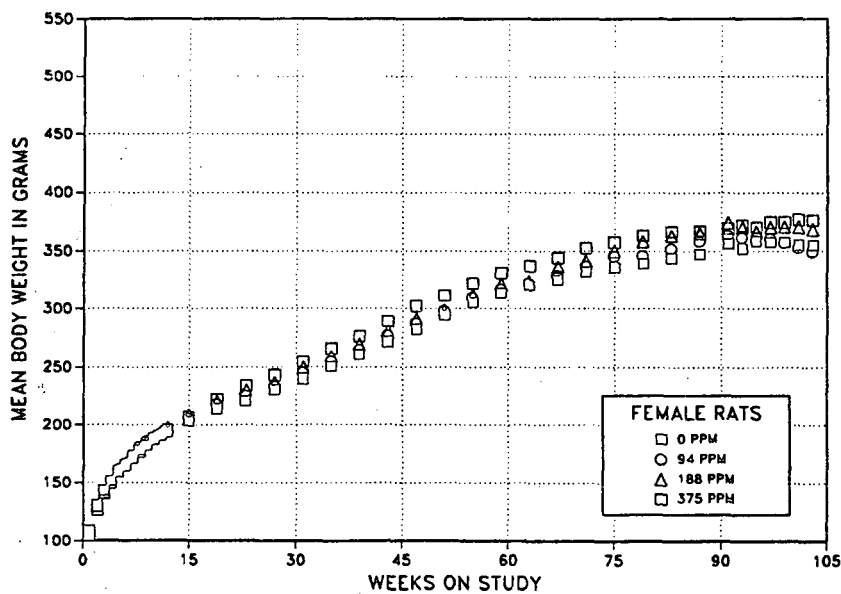
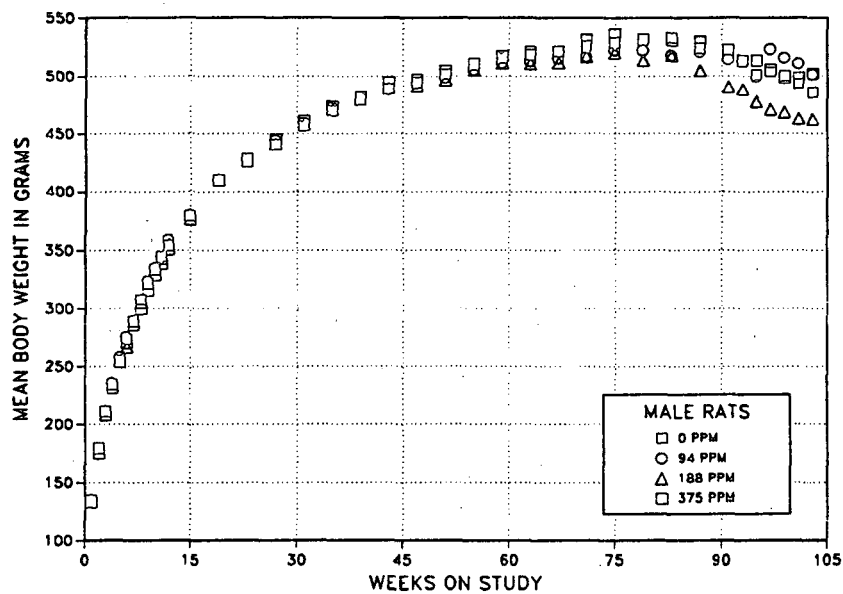

FIGURE 2
Growth Curves for Male and Female Rats Exposed to Nitromethane by Inhalation for 2 Years

TABLE 7
Mean Body Weights and Survival of Male Rats in the 2-Year Inhalation Study of Nitromethane

Weeks on Study	0 ppm		94 ppm			188 ppm			375 ppm		
	Av. Wt. (g)	No. of Survivors	Av. Wt. (g)	Wt. (% of controls)	No. of Survivors	Av. Wt. (g)	Wt. (% of controls)	No. of Survivors	Av. Wt. (g)	Wt. (% of controls)	No. of Survivors
1	135	50	135	100	50	135	100	50	133	98	50
2	180	50	179	100	50	179	100	50	175	98	50
3	211	50	211	100	50	211	100	50	208	99	50
4	234	50	236	101	50	235	100	50	231	99	50
5	255	50	258	101	50	255	100	50	253	99	50
6	274	50	276	101	50	267	98	50	271	99	50
7	289	50	290	100	50	289	100	50	286	99	50
8	307	50	308	100	50	306	99	50	300	98	50
9	322	50	324	101	50	322	100	50	316	98	50
10	333	50	335	101	50	334	100	50	329	99	50
11	345	50	344	100	50	343	100	50	338	98	50
12	354	50	359	102	50	355	100	50	351	99	50
15	379	50	380	100	50	380	100	50	376	99	50
19	409	50	410	100	50	410	100	50	410	100	50
23	425	50	428	101	50	426	100	50	429	101	50
27	441	50	444	101	50	441	100	50	445	101	50
31	456	50	460	101	50	458	100	50	462	101	50
35	470	49	473	101	50	471	100	50	474	101	50
39	480	49	481	100	50	480	100	50	482	101	50
43	489	49	488	100	49	490	100	50	495	101	50
47	495	49	494	100	49	492	99	50	497	101	50
51	502	49	498	99	49	496	99	50	505	101	50
55	510	49	505	99	49	506	99	50	511	100	50
59	516	48	512	99	48	511	99	49	518	100	49
63	518	48	513	99	46	511	99	49	521	101	48
67	521	48	515	99	46	512	98	49	522	100	47
71	526	46	517	98	44	517	98	47	532	101	45
75	529	44	523	99	40	521	98	44	537	102	44
79	531	41	523	98	40	514	97	43	532	100	42
83	533	38	518	97	39	518	97	39	531	100	40
87	524	35	521	100	30	505	96	37	530	101	35
91	522	30	514	99	28	491	94	31	522	100	31
93	512	28	513	100	25	489	95	27	513	100	28
95	501	27	499	100	24	478	95	24	514	103	24
97	503	23	523	104	19	471	94	22	506	100	22
99	500	21	516	103	18	469	94	18	499	100	18
101	493	20	511	104	17	463	94	17	499	101	11
103	486	17	501	103	16	462	95	16	502	103	9
Mean for weeks											
1-13	270		271	100		269	100		266	99	
14-52	455		456	100		454	100		458	101	
53-103	514		514	100		496	96		518	101	

TABLE 8
Mean Body Weights and Survival of Female Rats in the 2-Year Inhalation Study of Nitromethane

Weeks on Study	0 ppm		94 ppm			188 ppm			375 ppm		
	Av. Wt. (g)	No. of Survivors	Av. Wt. (g)	Wt. (% of controls)	No. of Survivors	Av. Wt. (g)	Wt. (% of controls)	No. of Survivors	Av. Wt. (g)	Wt. (% of controls)	No. of Survivors
1	108	50	108	100	50	108	100	50	107	99	50
2	130	50	130	100	50	130	99	50	126	97	50
3	143	50	143	100	50	142	99	50	140	98	50
4	151	50	152	100	50	150	99	50	149	99	50
5	159	50	161	101	50	160	101	50	159	100	50
6	164	50	166	101	50	167	101	50	165	100	50
7	172	50	174	101	50	173	101	50	171	100	50
8	178	50	181	102	50	180	101	50	177	99	50
9	182	50	186	102	50	186	102	50	182	100	50
10	187	50	189	101	50	191	102	50	188	101	50
11	191	50	193	101	50	194	102	50	191	100	50
12	194	50	196	101	50	198	102	50	196	101	50
15	203	50	206	102	50	209	103	50	207	102	50
19	214	50	218	102	50	221	103	50	222	104	50
23	220	50	227	103	50	230	105	50	234	107	50
27	230	50	234	102	50	237	103	50	243	106	50
31	239	50	246	103	50	250	104	50	255	107	50
35	250	50	255	102	50	260	104	50	266	106	50
39	261	50	265	102	50	270	104	50	276	106	50
43	272	50	277	102	50	281	103	50	289	107	50
47	282	50	287	102	50	291	103	50	303	107	50
51	294	50	298	101	50	299	102	50	311	106	50
55	306	50	310	101	50	312	102	50	322	106	50
59	314	50	317	101	50	321	103	50	332	106	49
63	320	50	323	101	48	324	101	49	337	105	48
67	325	49	329	101	48	337	104	47	344	106	48
71	332	49	337	101	45	342	103	46	353	106	46
75	336	47	346	103	43	350	104	43	358	107	46
79	340	45	346	102	42	358	106	42	364	107	44
83	344	43	352	102	38	364	106	42	367	107	44
87	347	40	359	103	34	365	105	42	367	106	38
91	356	37	364	102	32	375	105	41	370	104	37
93	352	37	362	103	31	370	105	39	372	106	35
95	358	35	359	100	30	367	103	37	371	104	33
97	358	35	361	101	26	370	104	35	375	105	28
99	358	32	357	100	24	371	104	33	375	105	27
101	355	32	353	99	22	371	104	31	377	106	27
103	355	30	350	99	22	369	104	30	376	106	25
Mean for weeks											
1-13	163		165	101		165	101		163	100	
14-52	247		251	102		255	103		261	106	
53-103	341		345	101		354	104		360	106	

Pathology and Statistical Analyses

This section describes the statistically significant or biologically noteworthy changes in the incidences of neoplasms and nonneoplastic lesions of the mammary gland and kidney and in the incidences of mononuclear cell leukemia. Summaries of the incidences of neoplasms and nonneoplastic lesions, individual animal tumor diagnoses, statistical analyses of primary neoplasms that occurred with an incidence of at least 5% in at least one animal group, and historical incidences for the neoplasms mentioned in this section are presented in Appendix A for male rats and Appendix B for female rats.

Mammary Gland: The incidences of fibroadenoma, fibroadenoma or adenoma (combined), and fibroadenoma, adenoma, or carcinoma (combined) in female rats increased with increasing exposure concentration, and the incidences in the 188 and 375 ppm groups were significantly greater than those in the controls (Tables 9 and B3). Additionally, the incidences of carcinoma and adenoma or carcinoma (combined) in the 375 ppm group were significantly greater than those in the controls. The incidences of fibroadenoma and carcinoma exceeded the ranges of historical incidences for these neoplasms in untreated (chamber control) female rats in 2-year NTP inhalation studies (Table B4). No treatment-related mammary gland neoplasms were observed in male rats (Table A1).

The morphology of the mammary gland fibroadenomas was typical, with the lesions characterized by dense, fibrous tissue surrounding scattered glands (Plate 1).

Adenomas were composed of glands with scant fibrous tissue. The carcinomas were very cellular lesions (Plate 2) that often contained a well-differentiated glandular formation (Plate 3); other mammary gland carcinomas exhibited a papillary pattern or showed more solid areas of growth. Mammary gland carcinomas contained occasional areas of necrosis and hemorrhage, and in some cases mitotic activity was quite high. The two carcinomas that metastasized to the lung (Plate 4) did not vary appreciably in morphology from the carcinomas that did not metastasize.

Hematopoietic System: The incidences of mononuclear cell leukemia in exposed female rats were lower than the control incidence (0 ppm, 22/50; 94 ppm, 13/50; 188 ppm, 14/50; 375 ppm, 9/50), and the difference was significant in the 375 ppm group (Table B3). The incidences in all exposed groups fell below the historical range (30% to 54%) for leukemias (all types) in female chamber control rats in 2-year NTP inhalation studies. In addition, the incidences of mononuclear cell leukemia in exposed males were slightly, although not significantly, less than the control incidence (35/50, 27/50, 33/50, 25/50; Table A3); however, these decreases were not related to exposure concentration. The biological significance of these decreases is uncertain. However, the incidences in exposed females were well within the range of historical incidences for leukemias in untreated female control rats in NTP noninhalation (feed) studies (14%-52%), and the incidences in exposed males were within or slightly above the range of historical incidences in untreated males (32%-64%).

TABLE 9
Incidences of Neoplasms and Nonneoplastic Lesions of the Mammary Gland in Female Rats
in the 2-Year Inhalation Study of Nitromethane

	0 ppm	94 ppm	188 ppm	375 ppm
Mammary Gland ^a	50	50	50	50
Hyperplasia ^b	0	0	1 (3.0) ^c	2 (2.5)
Hyperplasia, Atypical	12 (1.7)	17 (1.2)	14 (1.4)	15 (1.7)
Fibroadenoma				
Overall rate ^d	19/50 (38%)	21/50 (42%)	33/50 (66%)	36/50 (72%)
Adjusted rate ^e	58.2%	68.5%	80.0%	92.1%
Terminal rate ^f	15/28 (54%)	10/19 (53%)	22/30 (73%)	20/23 (87%)
First incidence (days)	454	435	468	552
Logistic regression test ^g	P<0.001	P=0.219	P=0.003	P<0.001
Adenoma				
Overall rate	2/50 (4%)	0/50 (0%)	0/50 (0%)	2/50 (4%)
Carcinoma ^h				
Overall rate	2/50 (4%)	7/50 (14%)	1/50 (2%)	11/50 (22%)
Adjusted rate	6.0%	29.3%	2.0%	33.0%
Terminal rate	1/28 (4%)	4/19 (21%)	0/30 (0%)	5/23 (22%)
First incidence (days)	631	588	440	425
Logistic regression test	P=0.009	P=0.052	P=0.447N	P=0.011
Fibroadenoma, Adenoma, or Carcinoma ⁱ				
Overall rate	21/50 (42%)	25/50 (50%)	34/50 (68%)	41/50 (82%)
Adjusted rate	62.4%	74.9%	80.4%	95.2%
Terminal rate	16/28 (57%)	11/19 (58%)	22/30 (73%)	21/23 (91%)
First incidence (days)	454	435	440	425
Logistic regression test	P<0.001	P=0.112	P=0.006	P<0.001

^a Number of animals necropsied

^b Number of animals with lesion

^c Average severity grade of lesions in affected animals: 1=minimal, 2=mild, 3=moderate, 4=marked

^d Number of animals with neoplasm per number of animals necropsied

^e Kaplan-Meier estimated neoplasm incidence at the end of the study after adjustment for intercurrent mortality

^f Observed incidence in animals surviving until the end of the study

^g In the control column are the P values associated with the trend test. In the exposed group columns are the P values corresponding to the pairwise comparisons between the controls and that exposed group. The logistic regression test regards neoplasms in animals dying prior to terminal kill as nonfatal. A lower incidence in an exposed group is indicated by N.

^h Historical incidence for all 2-year NTP inhalation studies with chamber control groups (mean \pm standard deviation): 25/653 (3.8% \pm 2.7%); range, 0%-8%. Historical incidence (Battelle Pacific Northwest Laboratories): 14/348 (4.0% \pm 2.6%); range, 0%-8%.

ⁱ Historical incidence (all laboratories): 202/653 (30.9% \pm 9.1%); range, 16%-46%. Historical incidence (Battelle Pacific Northwest Laboratories): 108/348 (31.0% \pm 8.1%); range, 22%-46%.

Kidney: At the end of the study, renal tubule hyperplasia and adenoma were observed in a few exposed males (Tables 10, A3, and A5); the incidences were not related to exposure concentration. The incidences of renal tubule adenoma in exposed males were within or only slightly above the historical incidence range of 0% to 4% for these neoplasms in male chamber control rats in NTP inhalation studies; however, because no hyperplasia or adenomas were observed in the control group, additional step sections of the kidneys of control and exposed males were prepared. Adenomas were observed in step sections of the kidneys of two males in each of the control and 94 ppm groups and four males in the 375 ppm group (Tables 10 and A3), including multiple adenomas in one male each in the 94 and 375 ppm groups. However, the combined incidences of renal tubule adenoma (from the single and step sections) were not significantly different from the control incidence. Renal tubule hyperplasia was also identified in step sections of kidneys from exposed and control males; the incidence in the 375 ppm group (from step sections and combined single and

step sections) was slightly, but not significantly, greater than the control incidence.

Renal tubule hyperplasia consisted of tubules that were dilated approximately two to four times the normal diameter with lumens filled by clusters of renal tubule epithelial cells; these cells were somewhat pleomorphic, often with large nuclei with prominent nucleoli, and with cytoplasm varying from eosinophilic to slightly basophilic. Renal tubule adenomas consisted of cells that resembled those in the hyperplasia. However, the adenomas were larger (five or more tubule diameters) and generally had a more complex structure, often consisting of multiple, variably sized tubule-like structures or multiple solid clusters of cells separated by fine bands of stroma.

Nervous System: Histopathologic evaluation of hematoxylin- and eosin-stained sections of spinal cords and sciatic nerves from approximately 15 male and 15 female rats per group from the 0 and 375 ppm groups revealed no significant differences between exposed and control rats.

TABLE 10
Incidences of Neoplasms and Nonneoplastic Lesions of the Kidney in Male Rats
in the 2-Year Inhalation Study of Nitromethane

	0 ppm	94 ppm	188 ppm	375 ppm
Single Sections (Standard Evaluation)				
Kidney ^a	50	50	50	50
Nephropathy ^b	50 (2.8) ^c	50 (2.9)	50 (3.1)	50 (3.2)
Renal Tubule, Hyperplasia	0	3 (2.7)	2 (2.5)	1 (2.0)
Renal Tubule, Adenoma ^d				
Overall rate ^e	0/50 (0%)	3/50 (6%)	2/50 (4%)	1/50 (2%)
Adjusted rate ^f	0.0%	14.9%	14.3%	12.5%
Terminal rate ^g	0/13 (0%)	1/16 (6%)	2/14 (14%)	1/8 (13%)
First incidence (days)	— ⁱ	636	733 (T)	733 (T)
Logistic regression test ^h	P=0.487	P=0.107	P=0.252	P=0.403
Step Sections (Extended Evaluation)				
Kidney	50	50	50	50
Renal Tubule, Hyperplasia	6 (2.5)	7 (2.3)	5 (1.4)	12 (2.0)
Renal Tubule, Adenoma				
Overall rate	2/50 (4%)	2/50 (4%)	0/50 (0%)	4/50 (6%)
Adjusted rate	15.4%	12.5%	0.0%	22.7%
Terminal rate	2/13 (15%)	2/16 (13%)	0/14 (0%)	1/8 (13%)
First incidence (days)	733 (T)	733 (T)	—	650
Logistic regression test	P=0.184	P=0.622N	P=0.219N	P=0.283
Single Sections and Step Sections (Combined)				
Kidney	50	50	50	50
Renal Tubule, Hyperplasia	6 (2.5)	8 (2.5)	6 (1.7)	12 (2.0)
Renal Tubule, Adenoma				
Overall rate	2/50 (4%)	5/50 (10%)	2/50 (4%)	5/50 (10%)
Adjusted rate	15.4%	26.3%	14.3%	33.7%
Terminal rate	2/13 (15%)	3/16 (19%)	2/14 (14%)	2/8 (25%)
First incidence (days)	733 (T)	636	733 (T)	650
Logistic regression test	P=0.181	P=0.173	P=0.675N	P=0.158

(T)Terminal sacrifice

^a Number of animals with kidney examined microscopically

^b Number of animals with lesion

^c Average severity of lesions in affected rats: 1=minimal, 2=mild, 3=moderate, 4=marked

^d Historical incidence for all 2-year NTP inhalation studies with chamber control groups (mean ± standard deviation): 6/652 (0.9% ± 1.3%); range, 0%-4%. Historical incidence (Battelle Pacific Northwest Laboratories): 5/347 (1.4% ± 1.5%); range, 0%-4%.

^e Number of animals with neoplasm per number of animals with kidney examined microscopically

^f Kaplan-Meier estimated neoplasm incidence at the end of the study after adjustment for intercurrent mortality

^g Observed incidence in animals surviving until the end of the study

^h In the control column are the P values associated with the trend test. In the exposed group columns are the P values corresponding to the pairwise comparisons between the controls and that exposed group. The logistic regression test regards neoplasms in animals dying prior to terminal kill as nonfatal. A lower incidence in an exposed group is indicated by N.

ⁱ Not applicable; no neoplasms in animal group

MICE

16-DAY STUDY

All mice survived to the end of the study (Table 11). The final mean body weights and mean body weight gains of exposed males and females were similar to those of the controls. Clinical findings included hypoactivity and tachypnea in male and female mice in the 1,500 ppm groups near the end of the study.

The absolute and relative liver weights of male mice in the 750 and 1,500 ppm groups and female mice in all exposed groups were significantly greater than those of the controls (Table F3). The relative liver weight of males in the 375 ppm group was also significantly greater than that of the controls.

At necropsy, no lesions were observed grossly that were attributed to nitromethane exposure. Degeneration of the olfactory epithelium of the nose was observed microscopically in all males and females exposed to 375 ppm or greater; this lesion was of minimal severity in males and minimal to mild severity in females.

Exposure Concentration Selection Rationale: Due to the lack of significant toxicologic or histopathologic effects (including the absence of histopathologic effects in the lung), nitromethane exposure concentrations selected for use in the 13-week study were the same as for the 16-day study.

TABLE 11
Survival and Body Weights of Mice in the 16-Day Inhalation Study of Nitromethane

Concentration (ppm)	Survival ^a	Mean Body Weight ^b (g)			Final Weight Relative to Controls (%)
		Initial	Final	Change	
Male					
0	5/5	24.4 ± 0.3	26.7 ± 0.4	2.2 ± 0.3	
94	5/5	24.5 ± 0.3	27.5 ± 0.6	3.0 ± 0.6	103
188	5/5	24.5 ± 0.2	27.2 ± 0.5	2.8 ± 0.6	102
375	5/5	24.5 ± 0.2	26.5 ± 0.4	2.0 ± 0.4	99
750	5/5	24.6 ± 0.2	27.2 ± 0.5	2.5 ± 0.3	102
1,500	5/5	24.5 ± 0.2	27.1 ± 0.4	2.6 ± 0.3	102
Female					
0	5/5	18.8 ± 0.3	21.9 ± 0.4	3.1 ± 0.5	
94	5/5	18.8 ± 0.2	22.2 ± 0.3	3.4 ± 0.2	102
188	5/5	18.8 ± 0.3	22.0 ± 0.5	3.3 ± 0.5	101
375	5/5	18.8 ± 0.3	21.8 ± 0.5	3.0 ± 0.5	100
750	5/5	18.8 ± 0.3	22.4 ± 0.3	3.6 ± 0.4	102
1,500	5/5	18.9 ± 0.3	22.3 ± 0.3	3.4 ± 0.4	102

^a Number of animals surviving at 16 days/number initially in group

^b Weights and weight changes are given as mean ± standard error. Differences from the control group were not significant by Dunnett's test.

13-WEEK STUDY

All mice survived to the end of the study (Table 12). The final mean body weights and mean body weight gains of exposed males were similar to those of the controls. The final mean body weights and mean body weight gains of exposed females were similar to or slightly greater than those of the controls. There were no treatment-related clinical findings.

The absolute right kidney weights of all groups of exposed male mice except the 1,500 ppm group and the relative right kidney weights of all groups of exposed males were significantly greater than those of the controls (Table F4); the absolute right kidney weights of females exposed to 188 ppm or greater

and the relative right kidney weights of females in the 750 and 1,500 ppm groups were also significantly greater than those of the controls. The absolute liver weight of male mice in the 750 ppm group and the relative liver weights of males exposed to 375 ppm or greater were significantly greater than those of the controls.

Exposed male mice had significantly less epididymal spermatozoal motility than the controls (Table H2). The estrous cycle lengths of exposed females were significantly longer than the cycle length of the controls; exposed females spent more time in metestrus and proestrus and less time in estrus than the controls.

TABLE 12
Survival and Body Weights of Mice in the 13-Week Inhalation Study of Nitromethane

Concentration (ppm)	Survival ^a	Mean Body Weight ^b (g)			Final Weight Relative to Controls (%)
		Initial	Final	Change	
Male					
0	10/10	24.5 ± 0.2	34.3 ± 0.4	9.8 ± 0.4	
94	10/10	24.4 ± 0.2	34.1 ± 0.5	9.7 ± 0.6	100
188	10/10	24.0 ± 0.3	34.3 ± 0.8	10.3 ± 0.7	100
375	10/10	24.1 ± 0.4	34.1 ± 0.7	10.0 ± 0.5	100
750	10/10	24.3 ± 0.3	33.6 ± 0.3	9.3 ± 0.3	98
1,500	10/10	24.4 ± 0.3	34.1 ± 0.6	9.7 ± 0.4	99
Female					
0	10/10	19.8 ± 0.3	28.9 ± 0.7	9.1 ± 0.5	
94	10/10	19.9 ± 0.3	29.7 ± 0.7	9.8 ± 0.8	103
188	10/10	20.0 ± 0.3	30.9 ± 0.7	10.8 ± 0.6	107
375	10/10	20.4 ± 0.2	31.7 ± 0.8*	11.3 ± 0.8	110
750	10/10	20.4 ± 0.1	29.8 ± 0.6	9.4 ± 0.6	103
1,500	10/10	20.1 ± 0.3	29.1 ± 0.5	9.1 ± 0.3	101

* Significantly different ($P \leq 0.05$) from the control group by Dunnett's test

^a Number of animals surviving at 13 weeks/number initially in group

^b Weights and weight changes are given as mean ± standard error.

At necropsy, no lesions were observed grossly that were attributed to nitromethane exposure. Olfactory epithelial degeneration and respiratory epithelial hyaline droplets (not observed in the 16-day study) were observed microscopically in all male and female mice exposed to 375 ppm or greater (Table 13). Seven females in the 188 ppm group also had epithelial degeneration; one male and nine females in the 188 ppm groups and two females in the 94 ppm group had hyaline droplets. Olfactory epithelial degeneration was characterized by loss of orderly arrangement of the olfactory epithelium and thinning of the epithelium due to a loss of bipolar sensory neurons. Some of the remaining epithelial (sustentacular) cells contained hyaline droplets. Inflammation associated with these changes was minimal. Olfactory epithelial degeneration was more prominent along the dorsal meatus but was occasionally present along the medial aspects of the ethmoid turbinates close to the septum. Hyaline droplet formation of the respiratory epithelium, similar to that observed in the olfactory epithelium, was striking and was most frequently observed in the epithelium of the nasopharyngeal duct, nasal septum, and medial aspects of the nasal turbinates. The respiratory epithelium near the olfactory epithelium seemed particularly vulnerable.

In males, the average severity of the nasal lesions was minimal in the 188, 375, and 750 ppm groups and mild in the 1,500 ppm group. In females, the severity of olfactory epithelial degeneration was minimal in the 188 and 375 ppm groups and mild in the 750 and 1,500 ppm groups; the severity of respiratory epithelial hyaline droplets was minimal in the 94 and 188 ppm groups, mild in the 375 and 750 ppm groups, and moderate in the 1,500 ppm group.

All males and nine females in the 1,500 ppm groups had minimal extramedullary hematopoiesis of the spleen (Table 13); although this lesion was also observed in a few males and females exposed to 375 or 750 ppm, the incidences were low and the change was very subtle in these groups. No kidney, liver, or lung lesions were observed in exposed mice.

Exposure Concentration Selection Rationale: Due to the increased severity and extent of nasal lesions in mice in the 13-week study compared to those in the 16-day study and to the presence of splenic hematopoiesis in mice in the 1,500 ppm groups, the nitromethane exposure concentrations selected for the 2-year study in mice were 188, 375, and 750 ppm.

TABLE 13
Incidences of Selected Nonneoplastic Lesions in Mice in the 13-Week Inhalation Study of Nitromethane

	0 ppm	94 ppm	188 ppm	375 ppm	750 ppm	1,500 ppm
Male						
Nose/Turbinates ^a	10	10	10	10	10	10
Degeneration, Olfactory Epithelium ^b	0	0	0	10** (1.0) ^c	10** (1.3)	10** (2.0)
Hyaline Droplets, Respiratory Epithelium	0	0	1 (1.0)	10** (1.0)	10** (1.0)	10** (2.0)
Spleen	10	10	10	10	10	10
Extramedullary Hematopoiesis	0	1 (1.0)	0	1 (1.0)	2 (1.0)	10** (1.0)
Female						
Nose/Turbinates	10	10	10	10	10	10
Degeneration, Olfactory Epithelium	0	0	7** (1.0)	10** (1.0)	10** (2.0)	10** (3.0)
Hyaline Droplets, Respiratory Epithelium	0	2 (1.0)	9** (1.0)	10** (2.0)	10** (2.0)	10** (3.0)
Spleen	10	10	10	10	10	10
Extramedullary Hematopoiesis	0	0	0	2 (1.0)	3 (1.0)	9** (1.0)

** Significantly different ($P \leq 0.01$) from the control group by the Fisher exact test

^a Number of animals with tissue examined microscopically

^b Number of animals with lesion

^c Average severity of lesions in affected mice: 1 = minimal, 2 = mild, 3 = moderate, 4 = marked

2-YEAR STUDY

Survival

Estimates of 2-year survival probabilities for male and female mice are shown in Table 14 and in the Kaplan-Meier survival curves (Figure 3). The survival rate of females in the 750 ppm group was marginally greater than that of the controls.

Body Weights and Clinical Findings

Mean body weights are given in Tables 15 and 16 and Figure 4. The mean body weights of

exposed females were generally slightly greater than the mean body weights of the controls during the study but were generally similar to the mean body weight of the control females at the end of the study. The mean body weights of exposed and control males were similar throughout the study.

Clinical findings included swelling around the eyes and exophthalmos in exposed males and females. These findings were coincident with harderian gland neoplasms.

TABLE 14
Survival of Mice in the 2-Year Inhalation Study of Nitromethane

	0 ppm	188 ppm	375 ppm	750 ppm
Male				
Animals initially in study	50	50	50	50
Moribund	14	11	16	16
Natural deaths	5	3	4	5
Animals surviving to study termination	31	36	30	29
Percent probability of survival at end of study ^a	62	72	60	58
Mean survival (days) ^b	681	700	674	687
Survival analysis ^c	P=0.519	P=0.321N	P=0.960	P=0.949
Female				
Animals initially in study	50	50	50	50
Accidental deaths ^d	2	0	1	0
Moribund	16	17	20	12
Natural deaths	7	5	3	2
Animals surviving to study termination	25	28 ^e	26	36
Percent probability of survival at end of study	52	56	53	72
Mean survival (days)	662	663	673	695
Survival analysis	P=0.046N	P=1.000N	P=0.993N	P=0.056N

^a Kaplan-Meier determinations

^b Mean of all deaths (uncensored, censored, and terminal sacrifice)

^c The result of the life table trend test (Tarone, 1975) is in the control column, and the results of the life table pairwise comparisons (Cox, 1972) with the controls are in the exposed group columns. A negative trend or a lower mortality in an exposed group is indicated by N.

^d Censored from survival analyses

^e Includes one animal that died during the last week of the study

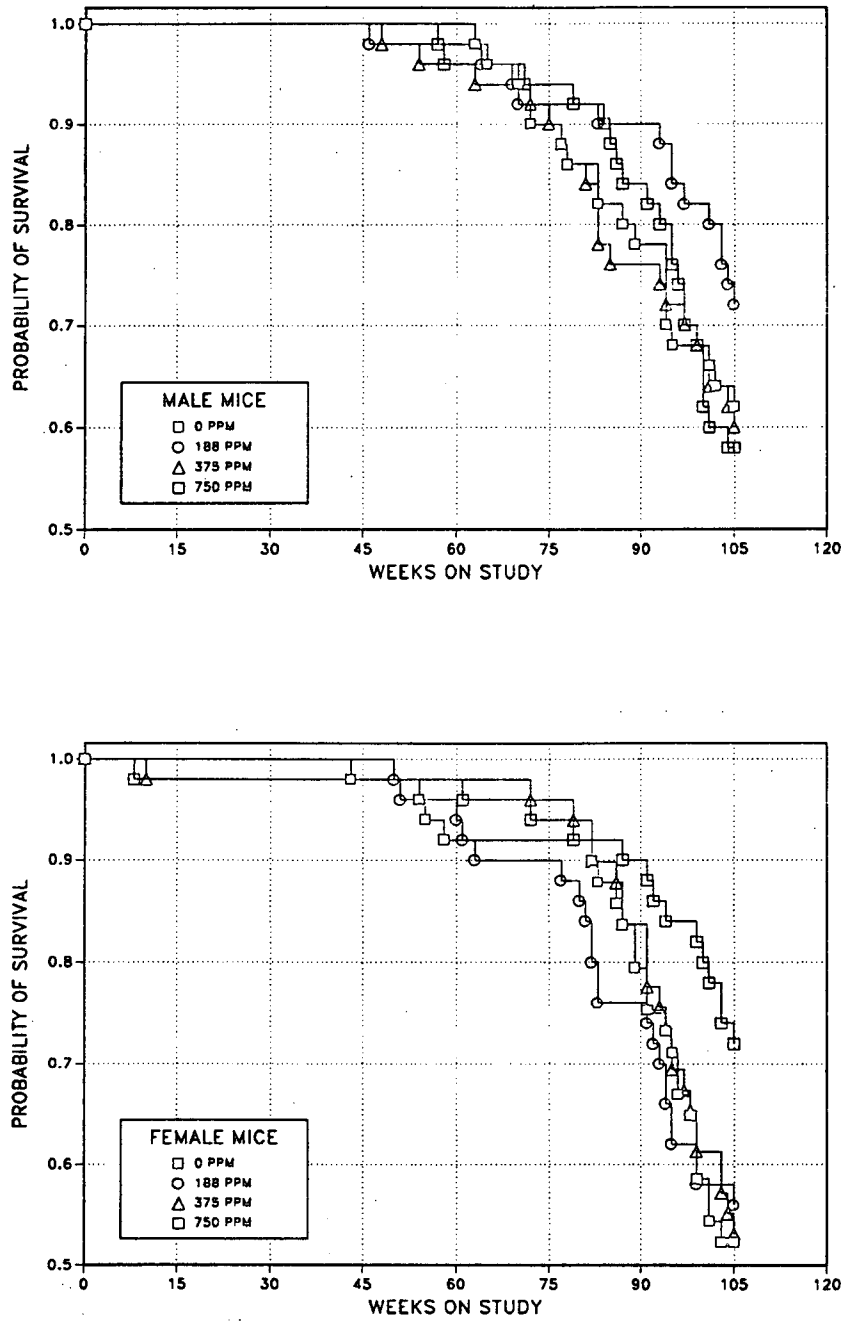

FIGURE 3
Kaplan-Meier Survival Curves for Male and Female Mice Exposed to Nitromethane by Inhalation for 2 Years

TABLE 15
Mean Body Weights and Survival of Male Mice in the 2-Year Inhalation Study of Nitromethane

Weeks on Study	0 ppm		188 ppm			375 ppm			750 ppm		
	Av. Wt. (g)	No. of Survivors	Av. Wt. (g)	Wt. (% of controls)	No. of Survivors	Av. Wt. (g)	Wt. (% of controls)	No. of Survivors	Av. Wt. (g)	Wt. (% of controls)	No. of Survivors
1	25.4	50	25.0	98	50	25.3	100	50	25.4	100	50
2	27.7	50	27.0	98	50	27.7	100	50	28.0	101	50
3	28.9	50	28.2	98	50	29.0	100	50	29.2	101	50
4	29.7	50	29.1	98	50	30.2	102	50	30.4	102	50
5	30.6	50	30.0	98	50	30.9	101	50	31.3	102	50
6	31.2	50	30.0	96	50	31.5	101	50	31.9	102	50
7	31.7	50	30.7	97	50	32.2	102	50	32.0	101	50
8	32.3	50	31.6	98	50	32.7	101	50	32.7	101	50
9	33.1	50	32.2	97	50	33.5	101	50	33.8	102	50
10	33.9	50	33.4	99	50	34.2	101	50	34.5	102	50
11	34.3	50	33.3	97	50	34.2	100	50	34.9	102	50
12	35.1	50	34.0	97	50	34.8	99	50	35.5	101	50
15	36.9	50	35.7	97	50	36.2	98	50	37.7	102	50
19	39.6	50	38.7	98	50	38.6	98	50	40.1	101	50
23	41.3	50	39.5	96	50	39.8	96	50	41.2	100	50
27	43.2	50	42.0	97	50	42.2	98	50	43.3	100	50
31	45.6	50	43.9	96	50	44.5	98	50	45.8	100	50
35	46.6	50	44.7	96	50	45.6	98	50	46.7	100	50
39	47.9	50	46.6	97	50	46.9	98	50	48.0	100	50
43	48.5	50	47.4	98	50	48.1	99	50	49.5	102	50
47	48.7	50	47.8	98	49	47.5	98	50	49.6	102	50
51	48.9	50	48.4	99	49	48.4	99	49	50.2	103	50
55	49.4	50	48.7	99	49	49.5	100	48	51.0	103	50
59	49.9	50	49.9	100	49	50.1	100	48	51.3	103	48
63	50.4	50	49.9	99	49	50.2	100	47	51.7	103	48
67	50.8	48	50.3	99	48	50.9	100	47	51.8	102	48
71	50.8	47	50.6	100	46	50.2	99	47	51.5	101	47
75	51.5	45	50.8	99	46	50.8	99	45	51.7	100	47
79	51.9	43	50.6	98	46	51.2	99	43	51.8	100	46
83	52.1	41	50.7	97	45	52.2	100	39	51.3	99	46
87	51.3	40	50.2	98	45	51.6	101	38	51.5	100	42
91	51.4	39	50.5	98	45	51.9	101	38	51.7	101	41
93	50.5	39	50.2	99	44	51.5	102	37	51.4	102	40
95	50.9	35	49.9	98	43	51.3	101	36	50.9	100	39
97	50.5	34	49.1	97	42	50.1	99	36	50.6	100	37
99	50.0	34	49.1	98	41	49.4	99	35	50.6	101	34
101	49.1	33	48.0	98	41	48.4	99	33	50.4	103	30
103	49.2	32	47.7	97	40	48.3	98	32	50.2	102	30
Mean for weeks											
1-13	31.2		30.4	97		31.4	101		31.6	101	
14-52	44.7		43.5	97		43.8	98		45.2	101	
53-103	50.6		49.8	98		50.5	100		51.2	101	

TABLE 16
Mean Body Weights and Survival of Female Mice in the 2-Year Inhalation Study of Nitromethane

Weeks on Study	0 ppm		188 ppm			375 ppm			750 ppm		
	Av. Wt. (g)	No. of Survivors	Av. Wt. (g)	Wt. (% of controls)	No. of Survivors	Av. Wt. (g)	Wt. (% of controls)	No. of Survivors	Av. Wt. (g)	Wt. (% of controls)	No. of Survivors
1	19.9	50	20.2	102	50	20.0	101	50	20.1	101	50
2	22.2	50	22.3	101	50	22.4	101	50	22.6	102	50
3	23.0	50	23.5	102	50	23.9	104	50	23.8	104	50
4	23.7	50	24.3	103	50	24.7	104	50	24.9	105	50
5	25.0	50	25.5	102	50	25.7	103	50	25.9	104	50
6	25.5	50	25.7	101	50	26.5	104	50	26.5	104	50
7	25.6	50	26.3	103	50	27.1	106	50	26.5	104	50
8	26.5	50	27.2	103	50	28.1	106	50	28.0	106	49
9	26.9	50	27.5	102	50	28.4	106	50	28.3	105	49
10	27.8	50	28.7	103	50	29.3	105	49	29.2	105	49
11	27.4	50	28.6	104	50	29.6	108	49	29.6	108	49
12	27.9	50	29.0	104	50	29.5	106	49	29.8	107	49
15	29.1	50	31.0	107	50	31.2	107	49	31.6	109	49
19	32.0	50	33.9	106	50	33.6	105	49	34.6	108	49
23	33.1	50	35.6	108	50	35.8	108	49	36.1	109	49
27	35.0	50	37.7	108	50	37.6	107	49	38.2	109	49
31	38.0	50	40.0	105	50	40.6	107	49	40.6	107	49
35	39.6	50	42.0	106	50	42.2	107	49	42.7	108	49
39	42.2	50	44.3	105	50	43.6	103	49	44.2	105	49
43	43.1	49	45.8	106	50	45.7	106	48	45.8	106	49
47	44.2	49	47.1	107	50	45.3	103	48	46.3	105	49
51	45.5	49	47.6	105	49	47.5	104	48	48.0	106	49
55	47.3	47	49.9	106	48	49.1	104	48	49.8	105	49
59	49.1	46	51.5	105	48	50.7	103	48	51.1	104	49
63	49.7	44	52.6	106	46	51.3	103	48	51.7	104	48
67	50.9	44	53.8	106	45	52.7	104	48	52.9	104	48
71	51.6	44	53.8	104	45	53.0	103	48	53.8	104	48
75	51.5	44	53.7	104	45	52.9	103	47	54.3	105	47
79	52.1	44	53.7	103	44	53.7	103	46	54.7	105	46
83	53.3	42	54.6	102	38	53.0	99	44	53.8	101	46
87	52.8	40	53.7	102	38	52.4	99	41	53.7	102	45
91	52.8	36	53.7	102	37	52.1	99	40	54.2	103	44
93	52.0	36	52.7	101	35	52.1	100	37	53.1	102	43
95	52.4	34	52.8	101	32	51.2	98	36	52.9	101	42
97	51.3	32	51.6	101	31	51.2	100	34	52.0	101	42
99	51.2	31	50.6	99	31	49.9	98	32	51.2	100	41
101	50.7	27	50.4	99	29	48.1	95	30	50.1	99	39
103	51.4	25	49.9	97	29	47.0	91	29	49.3	96	38
Mean for weeks											
1-13	25.1		25.7	102		26.3	105		26.3	105	
14-52	38.2		40.5	106		40.3	105		40.8	107	
53-103	51.3		52.4	102		51.3	100		52.4	102	

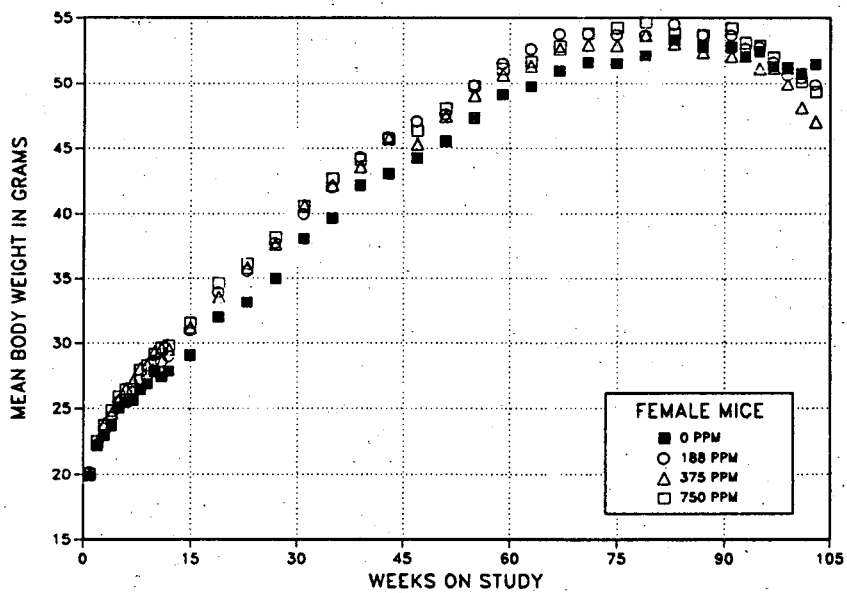
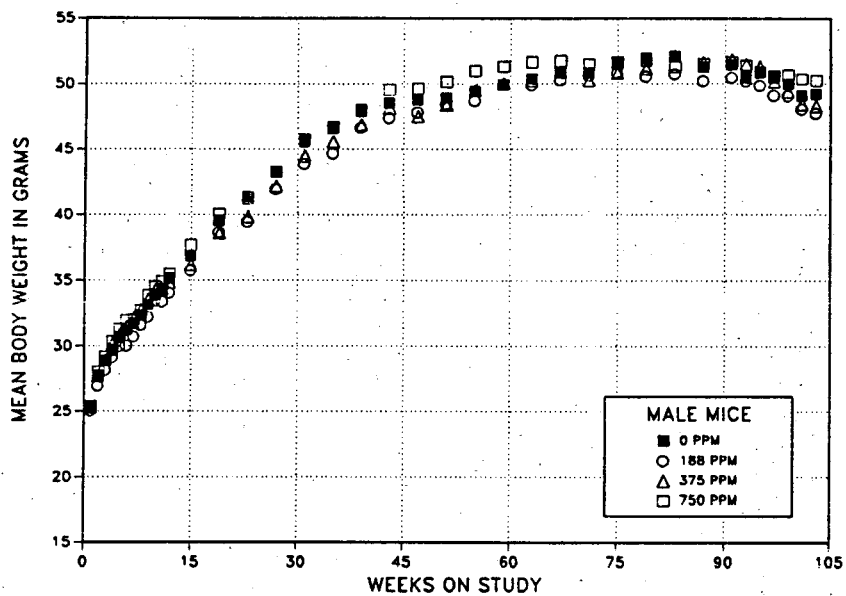

FIGURE 4
Growth Curves for Male and Female Mice Exposed to Nitromethane by Inhalation for 2 Years

Pathology and Statistical Analyses

This section describes the statistically significant or biologically noteworthy changes in the incidences of neoplasms and/or nonneoplastic lesions of the harderian gland, liver, lung, and nose. Summaries of the incidences of neoplasms and nonneoplastic lesions, individual animal tumor diagnoses, statistical analyses of primary neoplasms that occurred with an incidence of at least 5% in at least one animal group, and historical incidences for the neoplasms mentioned in this section are presented in Appendix C for male mice and Appendix D for female mice.

Harderian Gland: The incidences of harderian gland adenoma and adenoma or carcinoma (combined) in exposed mice increased with increasing exposure concentration and were significantly greater in males and females in the 375 and 750 ppm groups than in

the controls (Tables 17, C3, and D3). The incidences of these neoplasms in all exposed groups of males and females were greater than the historical control incidences for chamber control mice in 2-year NTP inhalation studies; however, the incidences of adenoma and adenoma or carcinoma (combined) in control males also exceeded the range of historical control incidences (Tables C4a and D4a). The incidences of carcinoma in males and females in the 375 and 750 ppm groups were also slightly greater than the incidences in the controls; although the differences were not statistically significant, the incidences of carcinoma in the 375 and 750 ppm groups were outside the historical incidence range of 0% to 4% for these neoplasms in male and female chamber control mice in 2-year NTP inhalation studies. The incidences of harderian gland hyperplasia in males and females in the 375 ppm groups

TABLE 17
Incidences of Neoplasms and Nonneoplastic Lesions of the Harderian Gland in Mice in the 2-Year Inhalation Study of Nitromethane

	0 ppm	188 ppm	375 ppm	750 ppm
Male				
Harderian Gland ^a	50	50	50	50
Hyperplasia ^b	2 (3.0) ^c	2 (1.5)	6 (1.7)	2 (3.5)
Adenoma				
Overall rate ^d	9/50 (18%)	10/50 (20%)	19/50 (38%)	32/50 (64%)
Adjusted rate ^e	26.6%	22.8%	51.9%	75.5%
Terminal rate ^f	7/31 (23%)	4/36 (11%)	13/30 (43%)	19/29 (66%)
First incidence (days)	545	448	520	497
Logistic regression test ^g	P<0.001	P=0.505	P=0.019	P<0.001
Carcinoma^h				
Overall rate	1/50 (2%)	1/50 (2%)	6/50 (12%)	5/50 (10%)
Adjusted rate	2.6%	2.8%	16.5%	14.7%
Terminal rate	0/31 (0%)	1/36 (3%)	3/30 (10%)	3/29 (10%)
First incidence (days)	653	734 (T)	436	595
Logistic regression test	P=0.036	P=0.762N	P=0.062	P=0.104
Adenoma or Carcinomaⁱ				
Overall rate	10/50 (20%)	11/50 (22%)	25/50 (50%)	37/50 (74%)
Adjusted rate	28.4%	25.3%	63.2%	83.7%
Terminal rate	7/31 (23%)	5/36 (14%)	16/30 (53%)	22/29 (76%)
First incidence (days)	545	448	436	497
Logistic regression test	P<0.001	P=0.506	P=0.001	P<0.001

(continued)

TABLE 17
Incidences of Neoplasms and Nonneoplastic Lesions of the Harderian Gland in Mice
in the 2-Year Inhalation Study of Nitromethane (continued)

	0 ppm	188 ppm	375 ppm	750 ppm
Female				
Harderian Gland	50	50	50	50
Hyperplasia	3 (1.3)	2 (3.5)	5 (3.0)	1 (1.0)
Adenoma				
Overall rate	5/50 (10%)	7/50 (14%)	16/50 (32%)	19/50 (38%)
Adjusted rate	16.0%	21.4%	43.1%	45.9%
Terminal rate	2/25 (8%)	4/28 (14%)	7/26 (27%)	14/36 (39%)
First incidence (days)	609	639	498	503
Logistic regression test	P<0.001	P=0.380	P=0.008	P=0.003
Carcinoma ^l				
Overall rate	1/50 (2%)	2/50 (4%)	4/50 (8%)	3/50 (6%)
Adjusted rate	2.9%	6.7%	14.1%	8.3%
Terminal rate	0/25 (0%)	1/28 (4%)	3/26 (12%)	3/36 (8%)
First incidence (days)	663	693	679	734 (T)
Logistic regression test	P=0.305	P=0.501	P=0.194	P=0.365
Adenoma or Carcinoma ^k				
Overall rate	6/50 (12%)	9/50 (18%)	20/50 (40%)	21/50 (42%)
Adjusted rate	18.4%	27.1%	53.5%	50.8%
Terminal rate	2/25 (8%)	5/28 (18%)	10/26 (38%)	16/36 (44%)
First incidence (days)	609	639	498	503
Logistic regression test	P<0.001	P=0.175	P=0.002	P=0.002

(T) Terminal sacrifice

^a Number of animals necropsied

^b Number of animals with lesion

^c Average severity grade of lesions in affected animals: 1=minimal, 2=mild, 3=moderate, 4=marked

^d Number of animals with neoplasm per number of animals necropsied

^e Kaplan-Meier estimated neoplasm incidence at the end of the study after adjustment for intercurrent mortality

^f Observed incidence in animals surviving until the end of the study

^g In the control column are the P values associated with the trend test. In the exposed group columns are the P values corresponding to the pairwise comparisons between the controls and that exposed group. The logistic regression test regards neoplasms in animals dying prior to terminal kill as nonfatal. A lower incidence in an exposed group is indicated by N.

^h Historical incidence for all 2-year NTP inhalation studies with chamber control groups (mean ± standard deviation): 2/950 (0.2% ± 0.9%); range, 0%-4%. Historical incidence (Battelle Pacific Northwest Laboratories): 2/450 (0.4% ± 1.3%); range, 0%-4%.

ⁱ Historical incidence (all laboratories): 49/950 (5.2% ± 4.5%); range, 0%-14%. Historical incidence (Battelle Pacific Northwest Laboratories): 38/450 (8.4% ± 4.0%); range, 2%-14%.

^j Historical incidence (all laboratories): 6/941 (0.6% ± 1.4%); range, 0%-4%. Historical incidence (Battelle Pacific Northwest Laboratories): 6/447 (1.3% ± 1.7%); range, 0%-4%.

^k Historical incidence (all laboratories): 32/941 (3.4% ± 4.4%); range, 0%-16%. Historical incidence (Battelle Pacific Northwest Laboratories): 27/447 (6.0% ± 5.0%); range, 0%-16%.

were similar to those in the controls (Tables 17 and C5). Hyperplasias were small focal lesions with increased numbers of secretory cells causing little if any compression of the adjacent parenchyma. Adenomas were generally larger and more expansive and caused compression of the adjacent parenchyma (Plate 5); some cellular atypia was noted, and the cells formed papillary, cystic, and glandular patterns. Harderian gland carcinomas were large neoplasms, often seen at necropsy, that involved the entire gland (Plate 6); many of these neoplasms showed encapsulation or local invasion.

Liver: Female mice in the 188 and 750 ppm groups had significantly greater incidences of hepatocellular adenoma and hepatocellular adenoma or carcinoma (combined) than the controls (Tables 18 and D3); the incidences of these neoplasms exceeded the historical control ranges of 0% to 40% for hepatocellular adenomas and 3% to 54% for hepatocellular adenomas or carcinomas (combined) for 2-year NTP inhalation studies (Table D4b). Females in the 188 and 750 ppm groups also had greater incidences of

multiple hepatocellular adenomas than the controls. The incidences of eosinophilic focus increased with increasing exposure concentration, and the incidences in the 375 and 750 ppm groups were significantly greater than the control incidence (Tables 18 and D5).

Eosinophilic foci consisted of isolated foci of increased numbers of hepatocytes and/or enlarged hepatocytes, usually of similar tinctorial nature as the rest of the liver; these lesions, which sometimes caused slight tissue compression, blended into the normal parenchyma at short angles so that a demarcation line was not always easily seen. Hepatocellular adenomas were usually larger than eosinophilic foci and compressed the surrounding tissue; these neoplasms contained basophilic cells and were sharply demarcated from the surrounding parenchyma due to the sharp angle of abutment and contrasting tinctorial quality. Hepatocellular carcinomas were large and irregular, with cellular atypia and pleomorphism, and contained trabecular patterns of cell growth.

TABLE 18
Incidences of Neoplasms and Nonneoplastic Lesions of the Liver in Female Mice
in the 2-Year Inhalation Study of Nitromethane

	0 ppm	188 ppm	375 ppm	750 ppm
Liver ^a	50	49	49	50
Eosinophilic Focus ^b	4	7	11*	15*
Hepatocellular Adenoma				
Overall rate ^c	14/50 (28%)	25/49 (51%)	17/49 (35%)	35/50 (70%)
Adjusted rate ^d	45.5%	68.6%	49.0%	83.1%
Terminal rate ^e	9/25 (36%)	17/28 (61%)	10/26 (38%)	29/36 (81%)
First incidence (days)	597	534	498	426
Logistic regression test ^f	P<0.001	P=0.013	P=0.364	P<0.001
Hepatocellular Adenoma, Multiple				
Overall rate	3/50 (6%)	13/49 (27%)**	4/49 (8%)	13/50 (26%)**
Hepatocellular Carcinoma ^g				
Overall rate	10/50 (20%)	14/49 (29%)	8/49 (16%)	12/50 (24%)
Adjusted rate	29.7%	35.7%	26.6%	25.6%
Terminal rate	3/25 (12%)	6/28 (21%)	6/26 (23%)	2/36 (6%)
First incidence (days)	576	534	548	426
Logistic regression test	P=0.329	P=0.195	P=0.383N	P=0.200
Hepatocellular Adenoma or Carcinoma ^h				
Overall rate	19/50 (38%)	34/49 (69%)	22/49 (45%)	40/50 (80%)
Adjusted rate	54.6%	82.4%	62.6%	86.9%
Terminal rate	10/25 (40%)	21/28 (75%)	14/26 (54%)	30/36 (83%)
First incidence (days)	576	534	498	426
Logistic regression test	P=0.001	P<0.001	P=0.368	P<0.001

* Significantly different ($P \leq 0.05$) from the control group by the logistic regression test

** $P \leq 0.01$

^a Number of animals with liver examined microscopically

^b Number of animals with lesion

^c Number of animals with neoplasm per number of animals with liver examined microscopically

^d Kaplan-Meier estimated neoplasm incidence at the end of the study after adjustment for intercurrent mortality

^e Observed incidence in animals surviving until the end of the study

^f In the control column are the P values associated with the trend test. In the exposed group columns are the P values corresponding to the pairwise comparisons between the controls and that exposed group. The logistic regression test regards neoplasms in animals dying prior to terminal kill as nonfatal. A lower incidence in an exposed group is indicated by N.

^g Historical incidence for all 2-year NTP inhalation studies with chamber control groups (mean \pm standard deviation): 103/937 (11.0% \pm 6.7%); range, 0%-30%. Historical incidence (Battelle Pacific Northwest Laboratories): 54/446 (12.1% \pm 8.1%); range, 2%-30%.

^h Historical incidence (all laboratories): 200/937 (21.3% \pm 11.9%); range, 3%-54%. Historical incidence (Battelle Pacific Northwest Laboratories): 95-446 (21.3% \pm 14.8%); range, 6%-54%.

Lung: The incidence of alveolar/bronchiolar carcinoma in male mice in the 750 ppm group was significantly greater than that in the controls (Tables 19 and C3) and exceeded the historical control range for these neoplasms in 2-year NTP inhalation studies (Table C4b). The incidence of alveolar/bronchiolar adenoma or carcinoma (combined) in females in the 750 ppm group was also significantly greater than in the controls and exceeded the historical control range (Tables 19, D3, and D4c). The incidence of alveolar/bronchiolar carcinoma in the female 375 ppm group was significantly greater than in controls but was within the historical control range. The incidence of alveolar/bronchiolar adenomas in females in the 750 ppm group also exceeded the historical control range. Females in the 375 ppm group had a

significantly greater incidence of cellular infiltration of histiocytes than the controls (Tables 19 and D5); the incidences of alveolar epithelial hyperplasia in exposed males and females were similar to those of the controls.

Alveolar/bronchiolar adenomas consisted of focal proliferations of cuboidal or columnar cells in alveolar areas; adenomas usually caused compression of surrounding tissue and loss of the basic alveolar structure. Alveolar/bronchiolar carcinomas had cellular anaplasia and compression; there was evidence of tissue invasion. Carcinomas had a higher nucleus:cytoplasm ratio than alveolar/bronchiolar adenomas.

TABLE 19
Incidences of Neoplasms and Nonneoplastic Lesions of the Lung in Mice in the 2-Year Inhalation Study of Nitromethane

	0 ppm	188 ppm	375 ppm	750 ppm
Male				
Lung^a	50	50	50	50
Infiltration Cellular, Histiocyte ^b	7 (2.4) ^c	2 (3.0)	3 (2.7)	6 (2.7)
Alveolar Epithelium, Hyperplasia	1 (1.0)	1 (1.0)	3 (2.7)	1 (3.0)
Alveolar/bronchiolar Adenoma				
Overall rate ^d	11/50 (22%)	10/50 (20%)	9/50 (18%)	12/50 (24%)
Adjusted rate ^e	30.8%	26.0%	30.0%	35.1%
Terminal rate ^f	8/31 (26%)	8/36 (22%)	9/30 (30%)	8/29 (28%)
First incidence (days)	449	646	734 (T)	497
Logistic regression test ^g	P=0.422	P=0.456N	P=0.412N	P=0.511
Alveolar/bronchiolar Carcinoma^h				
Overall rate	2/50 (4%)	3/50 (6%)	3/50 (6%)	11/50 (22%)
Adjusted rate	6.5%	8.3%	10.0%	30.4%
Terminal rate	2/31 (6%)	3/36 (8%)	3/30 (10%)	6/29 (21%)
First incidence (days)	734 (T)	734 (T)	734 (T)	586
Logistic regression test	P=0.001	P=0.569	P=0.485	P=0.009
Alveolar/bronchiolar Adenoma or Carcinomaⁱ				
Overall rate	13/50 (26%)	13/50 (26%)	12/50 (24%)	20/50 (40%)
Adjusted rate	36.8%	33.9%	40.0%	51.2%
Terminal rate	10/31 (32%)	11/36 (31%)	12/30 (40%)	11/29 (38%)
First incidence (days)	449	646	734 (T)	497
Logistic regression test	P=0.059	P=0.517N	P=0.515N	P=0.105

(continued)

TABLE 19
Incidences of Neoplasms and Nonneoplastic Lesions of the Lung in Mice in the 2-Year Inhalation Study of Nitromethane (continued)

	0 ppm	188 ppm	375 ppm	750 ppm
Female				
Lung	50	50	49	50
Infiltration Cellular, Histiocyte	0	1 (1.0)	6* (2.5)	4 (2.8)
Alveolar Epithelium, Hyperplasia	3 (2.3)	1 (2.0)	5 (2.0)	1 (3.0)
Alveolar/bronchiolar Adenoma				
Overall rate	3/50 (6%)	3/50 (6%)	2/49 (4%)	9/50 (18%)
Adjusted rate	11.5%	10.7%	4.3%	22.7%
Terminal rate	2/25 (8%)	3/28 (11%)	0/26 (0%)	6/36 (17%)
First incidence (days)	716	734 (T)	498	426
Logistic regression test	P=0.022	P=0.632N	P=0.514N	P=0.083
Alveolar/bronchiolar Carcinoma^l				
Overall rate	0/50 (0%)	3/50 (6%)	5/49 (10%)	3/50 (6%)
Adjusted rate	0.0%	8.3%	15.0%	7.2%
Terminal rate	0/25 (0%)	1/28 (4%)	2/26 (8%)	1/36 (3%)
First incidence (days)	— ^k	534	602	503
Logistic regression test	P=0.149	P=0.119	P=0.033	P=0.110
Alveolar/bronchiolar Adenoma or Carcinoma^l				
Overall rate	3/50 (6%)	6/50 (12%)	6/49 (12%)	12/50 (24%)
Adjusted rate	11.5%	18.5%	16.8%	28.7%
Terminal rate	2/25 (8%)	4/28 (14%)	2/26 (8%)	7/36 (19%)
First incidence (days)	716	534	498	426
Logistic regression test	P=0.007	P=0.243	P=0.238	P=0.015

* Significantly different ($P \leq 0.05$) from the control group by the logistic regression test

(T) Terminal sacrifice

^a Number of animals with lung examined microscopically

^b Number of animals with lesion

^c Average severity grade of lesions in affected animals: 1=minimal, 2=mild, 3=moderate, 4=marked

^d Number of animals with neoplasm per number of animals with lung examined microscopically

^e Kaplan-Meier estimated neoplasm incidence at the end of the study after adjustment for intercurrent mortality

^f Observed incidence in animals surviving until the end of the study

^g In the control column are the P values associated with the trend test. In the exposed group columns are the P values corresponding to the pairwise comparisons between the controls and that exposed group. The logistic regression test regards neoplasms in animals dying prior to terminal kill as nonfatal. A lower incidence in an exposed group is indicated by N.

^h Historical incidence for all 2-year NTP inhalation studies with chamber control groups (mean \pm standard deviation): 75/947 (7.9% \pm 5.7%); range, 0%-16%. Historical incidence (Battelle Pacific Northwest Laboratories): 37/448 (8.3% \pm 5.8%); range, 0%-16%.

ⁱ Historical incidence (all laboratories): 205/947 (21.7% \pm 8.0%); range, 10%-42%. Historical incidence (Battelle Pacific Northwest Laboratories): 108/448 (24.1% \pm 9.5%); range, 10%-42%.

^j Historical incidence (all laboratories): 38/939 (4.1% \pm 3.2%); range, 0%-12%. Historical incidence (Battelle Pacific Northwest Laboratories): 15/446 (3.4% \pm 2.4%); range, 0%-6%.

^k Not applicable; no neoplasms in animal group

^l Historical incidence (all laboratories): 97/939 (10.3% \pm 3.7%); range, 0%-16%. Historical incidence (Battelle Pacific Northwest Laboratories): 46/446 (10.3% \pm 4.6%); range, 0%-16%.

Nose: The incidences of several nonneoplastic nasal lesions, similar to but more severe than those observed in the 13-week study, were generally significantly greater in exposed male and female mice than those in the controls (Tables 20, C5, and D5). These lesions included degeneration and metaplasia of the olfactory epithelium and hyaline degeneration of the respiratory epithelium (not observed in the 13-week study). The minimal to moderate olfactory degeneration was most prominent along the middle and posterior sections of the dorsal meatus and at the tips of the ethmoid turbinates; this lesion consisted of degeneration and loss of sensory neurons, nerve atrophy, and dilation of Bowman's glands (Plates 7

and 8). The metaplastic lesions, which represented a sequelae to degeneration, were characterized by replacement of the damaged olfactory epithelium with ciliated respiratory epithelium. Hyaline degeneration of the respiratory epithelium was characterized by accumulation of eosinophilic hyaline droplets in cells lining the nasopharyngeal duct, nasal septum, medial surface of the middle nasoturbinates, and some of the glandular epithelium beneath the respiratory epithelium of the middle nasal section. In addition, there was minimal suppurative inflammation of the nasolacrimal duct in males in the 375 and 750 ppm groups. The association of this marginally increased incidence with exposure to nitromethane is uncertain.

TABLE 20
Incidences of Nonneoplastic Lesions of the Nose in Mice in the 2-Year Inhalation Study of Nitromethane

	0 ppm	188 ppm	375 ppm	750 ppm
Male				
Nose ^a	50	49	50	50
Nasolacrimal Duct, Inflammation ^b	2 (1.5) ^c	3 (1.3)	10* (1.9)	10* (1.9)
Olfactory Epithelium, Atrophy, Focal	3 (1.0)	8* (1.1)	0	0
Olfactory Epithelium, Degeneration	0	10** (1.1)	50** (2.5)	50** (3.1)
Olfactory Epithelium, Metaplasia	0	1 (2.0)	41** (1.8)	49** (2.0)
Respiratory Epithelium, Degeneration, Hyaline	5 (1.0)	5 (1.2)	50** (1.9)	50** (2.0)
Female				
Nose	50	49	50	50
Nasolacrimal Duct, Inflammation	1 (2.0)	0	3 (1.7)	3 (2.0)
Olfactory Epithelium, Atrophy, Focal	2 (1.0)	6 (1.0)	0	0
Olfactory Epithelium, Degeneration	0	22** (1.1)	50** (2.7)	50** (3.2)
Olfactory Epithelium, Metaplasia	0	2 (1.0)	46** (1.9)	48** (2.2)
Respiratory Epithelium, Degeneration, Hyaline	16 (1.1)	39** (1.5)	50** (2.0)	50** (2.5)

* Significantly different ($P \leq 0.05$) from the control group by the logistic regression test

** $P \leq 0.01$

^a Number of animals with nose examined microscopically

^b Number of animals with lesion

^c Average severity grade of lesions in affected animals: 1=minimal, 2=mild, 3=moderate, 4=marked

GENETIC TOXICOLOGY

Nitromethane was not mutagenic *in vitro* or *in vivo*. Results of tests for induction of mutations by nitromethane (100 to 10,000 $\mu\text{g}/\text{plate}$) in *Salmonella typhimurium* strains TA98, TA100, TA1535, and TA1537 were negative with and without induced S9 enzymes (Table E1; Mortelmans *et al.*, 1986). No induction of sister chromatid exchanges (Table E2) or

chromosomal aberrations (Table E3) was observed in cultured Chinese hamster ovary cells treated with up to 5,000 $\mu\text{g}/\text{mL}$ nitromethane. Nitromethane administered by inhalation for 13 weeks at concentrations up to 1,500 ppm did not induce increased frequencies of micronucleated erythrocytes in the peripheral blood of male or female mice (Table E4).

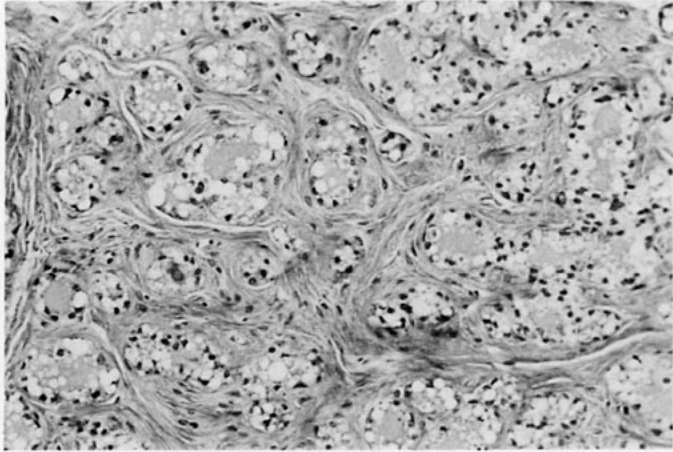

PLATE 1
 Mammary gland fibroadenoma from a female F344/N rat exposed to 375 ppm nitromethane by inhalation for 2 years. The neoplasm contains nests of glands separated by prominent bands of collagen. H&E; 150×

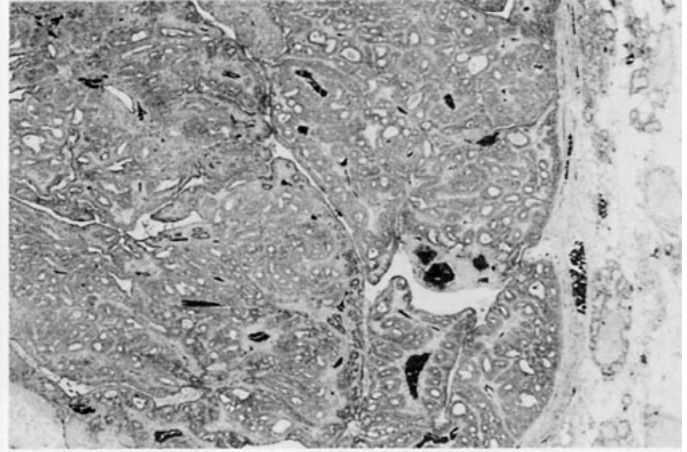

PLATE 2
 Mammary gland carcinoma from a female F344/N rat exposed to 375 ppm nitromethane by inhalation for 2 years. The neoplasm has a glandular pattern. H&E; 35×

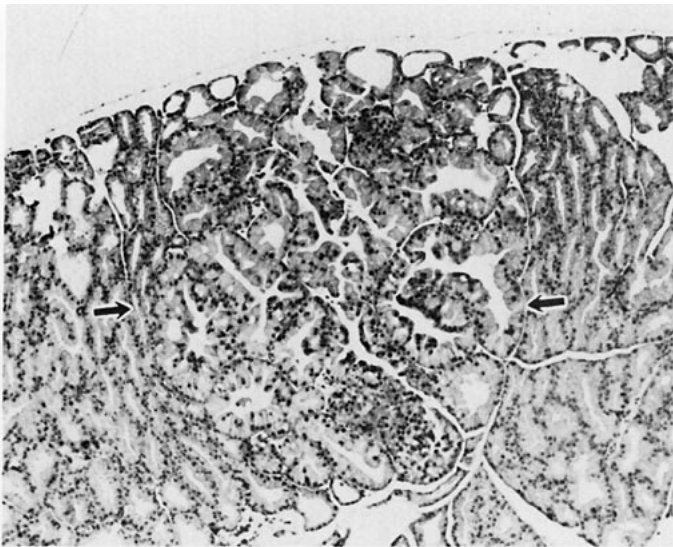

PLATE 3
 Detail of a mammary gland carcinoma from a female F344/N rat exposed to 375 ppm nitromethane by inhalation for 2 years. Mitotic figures are common (arrows). H&E; 240×

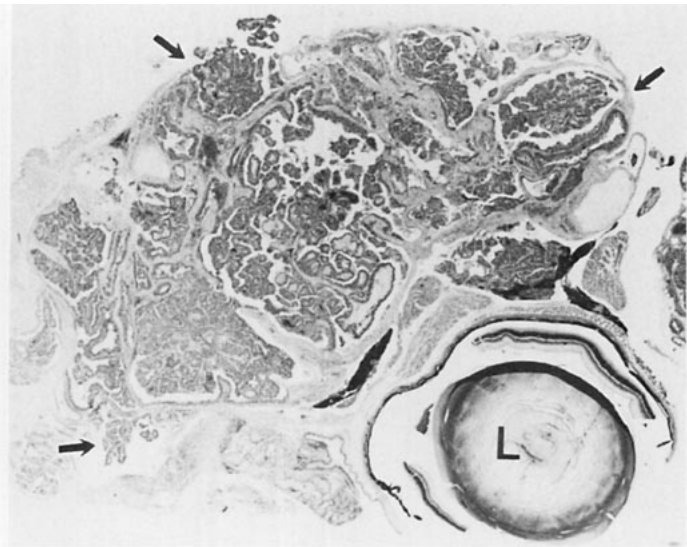

PLATE 4
 Metastatic mammary gland carcinoma in the lung of a female F344/N rat exposed to 375 ppm nitromethane by inhalation for 2 years. The neoplasm obliterates a major pulmonary vessel (arrows). Bronchus (B). H&E; 35×

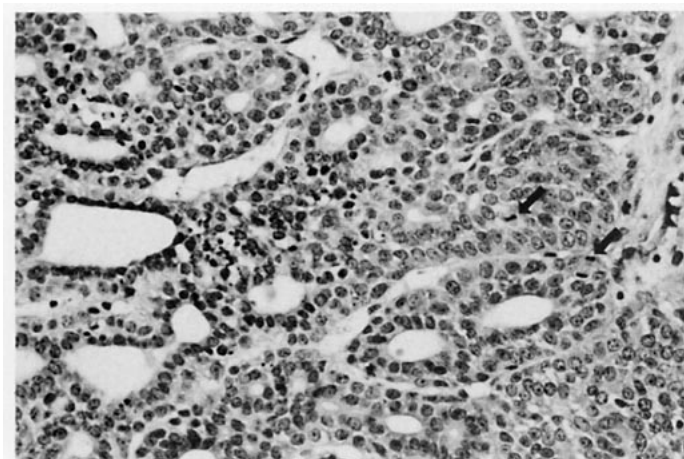

PLATE 5
 Small harderian gland adenoma (between arrows) from a male B6C3F₁ mouse exposed to 750 ppm nitromethane by inhalation for 2 years. H&E; 11 ×

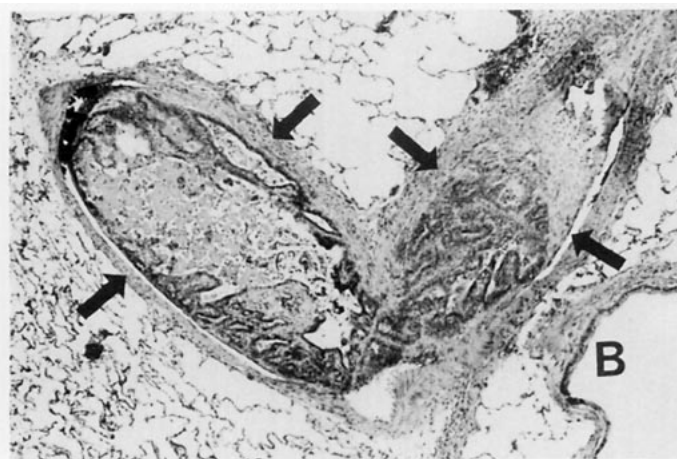

PLATE 6
 Large harderian gland carcinoma (between arrows) from a male B6C3F₁ mouse exposed to 750 ppm nitromethane by inhalation for 2 years. The neoplasm nearly surrounds the eye of the mouse. Note the lens (L) of the eye. H&E; 55 ×

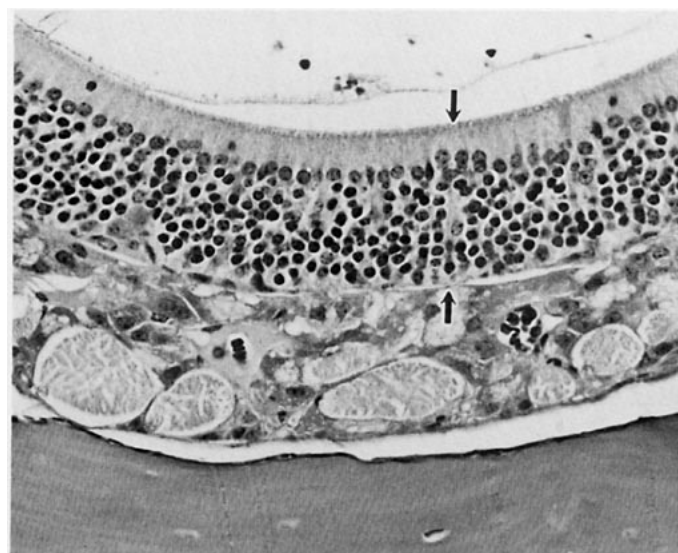

PLATE 7
 Normal olfactory epithelium at level II of the nasal cavity of a control male B6C3F₁ mouse. Note the plump olfactory epithelium between the arrows. H&E; 340 ×

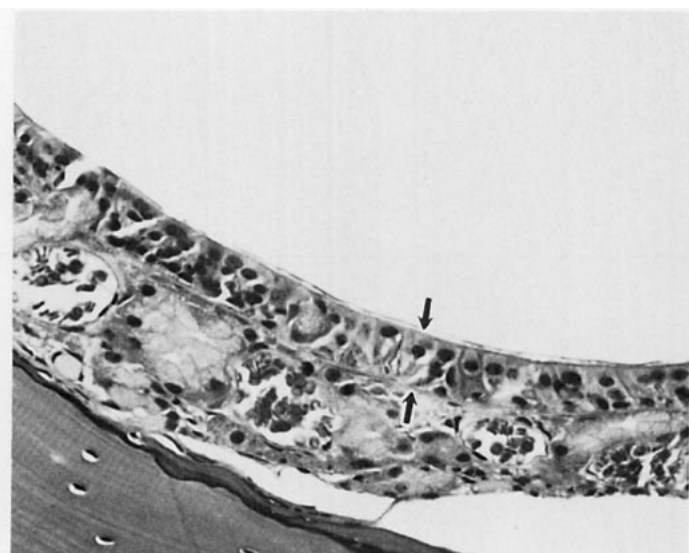

PLATE 8
 Degeneration of the olfactory epithelium at level II of the nasal cavity in a male B6C3F₁ mouse exposed to 750 ppm nitromethane by inhalation for 2 years. Note the attenuated olfactory epithelium between the arrows. H&E; 340 ×

DISCUSSION AND CONCLUSIONS

Nitromethane was evaluated for toxicity and carcinogenicity in 16-day, 13-week, and 2-year studies in F344/N rats and B6C3F₁ mice, with whole body inhalation as the route of exposure.

Although there were a number of effects that were considered treatment related in rats in the 13-week study, most were not of great enough severity or incidence to determine exposure concentrations for the 2-year study. The deciding factor for the selection of exposure concentrations for the 2-year study was the neurotoxicologic findings in the 13-week study: loss of grip strength in males exposed to 1,500 ppm, hindlimb paralysis in rats in the 750 and 1,500 ppm groups, and sciatic nerve and spinal cord lesions in rats exposed to 375 ppm or greater. The effects in rats exposed to 750 ppm or greater were considered too severe, while the lesions observed at 375 ppm were very subtle and were less severe than those observed in the 16-day study. In the absence of significant short-term exposure-related effects, 375 ppm was selected as the highest exposure concentration for the 2-year rat study.

The primary factors influencing the selection of exposure concentrations for the 2-year mouse study were the incidence and severity of nasal lesions in male and female mice exposed to 1,500 ppm in the 13-week study. Also considered in the selection was the presence of extramedullary hematopoiesis of the spleen in male and female mice exposed to 1,500 ppm. Because the nasal lesions were considered too severe, 750 ppm was selected as the highest exposure concentration for the 2-year study.

There was a marked microcytic, regenerative anemia in exposed rats in the 13-week study, accompanied by red cell fragmentation, Heinz body formation, and increased methemoglobin production, although not extensive. Bone marrow hyperplasia, consistent with the anemia, was present in exposed rats. However, as one might expect with such hematotoxic effects, there were no treatment-related findings in the spleen of exposed rats. Incidences of extramedullary

hematopoiesis of the spleen were significantly increased in male and female mice exposed to 1,500 ppm in the 13-week study. No hematologic evaluation was performed for mice in this study. Reductions in serum thyroxine concentration and increased thyroid gland weights have been observed in New Zealand white rabbits exposed for 6 months to 745 ppm nitromethane (Lewis *et al.*, 1979). On day 23 of the 13-week study, a hypothyroid state, as evidenced by reduced serum triiodothyronine, thyroxine, and free thyroxine concentrations, was observed in exposed rats. However, this effect was transient in that thyroid gland hormone concentrations and thyroid gland weights were similar to those of the controls at the end of the study.

In the 2-year rat study, neither survival rates nor weight gains were significantly affected by nitromethane exposure. The lack of neurobehavioral clinical signs and neuropathological changes in the 2-year study suggests that the exposure concentrations were sufficiently low to prevent cumulative neurotoxic effects and that the rats had adapted to any effects that might have occurred early in the study; evaluation of spinal cords and sciatic nerves from male and female rats in the 0 and 375 ppm groups revealed no significant differences between exposed and control rats. There were no treatment-related clinical findings other than the gross observation of mammary gland swellings in female rats. Nitromethane exposure caused increased incidences of mammary gland neoplasms in female rats, as evidenced by exposure concentration-related increases in fibroadenoma; carcinoma; and fibroadenoma, adenoma, or carcinoma (combined). While the incidence of mammary gland neoplasms in control female rats (42%) was near the upper bound of the historical control range (16%-46%), the observed control neoplasm incidence was similar to the 46% rate predicted by the Seilkop logistic regression model (Seilkop, 1995) for control animals with an equivalent survival rate and 52-week mean body weight. Moreover, the slightly elevated body weights of females in the 188 and 375 ppm groups

could not account for the markedly increased incidences of mammary gland neoplasms observed in these groups. There were no treatment-related increases in the incidences of neoplasms or non-neoplastic lesions at any site in male rats. The presence of renal tubule adenomas only in exposed animals (0/50, 3/50, 2/50, 1/50) was investigated by preparing kidney step sections for control and exposed male rats. Additional adenomas were observed in step sections from exposed and control groups (2/50, 2/50, 0/50, 4/50); however, the combined incidences of renal tubule adenoma for step sections and original kidney sections (2/50, 5/50, 2/50, 5/50) did not indicate a significant treatment-related increase in the incidence of this neoplasm.

During the 2-year mouse study, the survival rate for females in the 750 ppm group was marginally greater than that of controls. Exposed female mice generally weighed slightly more than the controls; however, body weights of control and exposed females were similar at the end of the study. Survival rates and body weights of treated male mice were similar to those of the controls. The only clinical findings observed during the 2-year study were swelling around the eyes and exophthalmos. These findings were consistent with increased incidences of harderian gland adenomas and carcinomas in exposed mice. The incidences of harderian gland neoplasms in control mice were somewhat greater than the historical control mean; however, the increased incidences of harderian adenomas or carcinomas (combined) were highly significant in males and females exposed to 375 or 750 ppm and were considered to be caused by exposure to nitromethane.

Nitromethane exposure caused a significant increase in the incidences of hepatocellular adenomas and adenomas or carcinomas (combined) in female mice in the 188 and 750 ppm groups. The incidences of multiple adenomas were increased in these two groups as well. The incidences of eosinophilic foci, considered to be part of the continuum of hepatic neoplasms, were marginally increased with increasing exposure concentration. As stated previously, exposed female mice had slightly greater mean body weights and lived slightly longer than control females; moreover, liver neoplasm incidences did correlate with body weight. However, application of the Seilkop logistic regression model (Seilkop, 1995)

suggests that marginal body weight differences and/or increased survival rates could not account for the increased incidences of neoplasms observed in the 188 and 750 ppm groups. There is a somewhat unusual inversion in the treatment response in that the 375 ppm group incidence is consistent with the control incidence. The control incidence (38%) is slightly greater than the mean historical control incidence of 21.3%, but is still well within the historical control range (3%-54%). The increased incidences of these hepatocellular neoplasms were considered to be caused by nitromethane exposure.

The secondary nitroalkane 2-nitropropane has been shown to cause increased incidences of hepatocellular neoplasms in rats administered the compound by inhalation (Lewis *et al.*, 1979) or gavage (Fiala *et al.*, 1987). The primary alkanes nitroethane (Griffin *et al.*, 1988), 1-nitropropane (Griffin *et al.*, 1982), and tetranitromethane (NTP, 1990) have not been shown to cause increased incidences of such neoplasms in rats. In addition, tetranitromethane (NTP, 1990) and 3-nitro-3-hexene (Deichman *et al.*, 1963) did not cause hepatocellular neoplasms in mice. No reports of carcinogenicity studies in mice were found in the literature for nitroethane, 1-nitropropane, or 2-nitropropane.

A number of studies have been conducted to investigate the possible mechanism of 2-nitropropane-induced hepatic neoplasms and the lack of such effects by primary nitroalkanes in rats. The primary and secondary mononitroalkanes exist in a state of equilibrium between the protonated neutral nitroalkanes, the nonprotonated nitronic acid and its anion, or nitronate in aqueous solution. Löfroth *et al.* (1986) have demonstrated that nitrite is not the major cause of mutagenicity of nitroalkanes in various *Salmonella* strains. At cellular pH, the secondary nitroalkanes have a much higher relative concentration of the nitronate anion and nitronic acid forms than the primary nitroalkanes; therefore, Löfroth *et al.* (1986) hypothesized that the anion or the acid may be the ultimate mutagen. In general, the primary nitroalkanes nitromethane, nitroethane, 1-nitropropane, and 1-nitrobutane and their nitronates are not mutagenic (Conaway *et al.*, 1991a; Davis, 1993). 2-Nitropropane, its nitronate 2-propyl-2-nitronate, and the nitronates of 2-nitrobutane and 3-nitropentane are mutagenic (Conaway *et al.*;

1991a). The nitronates were more powerful mutagens than their respective parent compounds. Nitroethane, 1-nitropropane, and 2-nitropropane (Davis *et al.*, 1993) do not induce micronuclei in erythrocytes from mice, similar to nitromethane in the 13-week studies. In human lymphocytes exposed in culture, 2-nitropropane, but not 1-nitropropane, induces chromosomal aberrations and sister chromatid exchanges. Tetranitromethane does induce sister chromatid exchanges and chromosomal aberrations in cultured Chinese hamster ovary cells (NTP, 1990); however, as presented in this report, nitromethane did not induce either. 2-Nitropropane, but not 1-nitropropane, has been shown to induce DNA repair synthesis in rat hepatocytes (Andrae *et al.*, 1988) *in vitro* and *in vivo* and cause *in vivo* oxidative damage to rat liver DNA and RNA (Conaway *et al.*, 1991b), as indicated by the increase in 8-hydroxydeoxyguanosine and 8-hydroxyguanosine. The primary nitroalkanes 1-nitropropane, 1-nitrobutane, and 1-nitropentane did not produce DNA or RNA damage; however, the secondary nitroalkanes 2-nitropropane, 2-nitrobutane, and 2-nitropentane did. The 2-nitroalkanes produce electrochemically active species, presumably modified nucleosides. Conaway *et al.* (1991b) concluded that the metabolites were responsible for the DNA and RNA damage. Tetranitromethane has been shown to nitrate hydroxyl groups of proteins, primarily of tyrosine residues (Riordan and Vallee, 1972).

Several nitroalkanes have been shown to be metabolized by cytochrome P₄₅₀ in rat and mouse NADPH-dependent hepatic microsomes (Ullrich *et al.*, 1978, Sakurai *et al.*, 1980; Marker and Kulkarni, 1986; Dayal *et al.*, 1991). The specific activities of rat liver microsomes were greatest for 2-nitropropane nitronate and 2-nitropropane, followed by 1-nitropropane, nitromethane, and tetranitromethane. The substrate binding spectrum for nitromethane was different from the other nitro compounds in rat liver microsomes (Sakurai *et al.*, 1980) in that a possible cytochrome P₄₅₀-NO complex was formed. Formaldehyde and possibly nitric oxide were formed. Tetranitromethane had the same spectrum difference as nitromethane, but no formaldehyde was produced. 2-Nitropropane was metabolized to nitrite and acetone. In similar studies, Kuo and Fridovich (1986) have shown that the enzymatic denitrification of 2-nitropropane to acetone also results in the forma-

tion of free radicals, superoxide, and hydrogen peroxide. Cunningham and Matthews (1991) have demonstrated that 2-nitropropane given by gavage to F344/N rats causes hepatic cell proliferation, while 1-nitropropane does not. Chemicals with the aliphatic nitro group (-C-NO₂) have been added to a list of DNA-reactive subgroups recognized by the NTP for possible carcinogenic activity (Tennant and Ashby, 1991). It is not known whether the generation of reactive radicals directly or indirectly is involved in the mechanism of toxicity or carcinogenicity for some primary nitroalkanes and for nitromethane in particular.

Nitromethane exposure caused a significant increase in the incidence of alveolar/bronchiolar carcinomas in male mice exposed to 750 ppm, exceeding the historical control range. Although the incidence of alveolar/bronchiolar carcinomas was significant only in female mice exposed to 375 ppm, carcinomas were also found in the 188 and 750 ppm groups, while none were observed in the controls. In all exposed female groups the incidences of carcinoma were within the historical control range for female mice. The incidence of alveolar/bronchiolar adenoma or carcinoma (combined) was significantly increased in the 750 ppm group of females and was also elevated in the male 750 ppm group. The increased incidences of alveolar/bronchiolar neoplasms were considered to be treatment related in males and females. Exposure to tetranitromethane for 2 years caused increased incidences of alveolar/bronchiolar adenomas and carcinomas in male and female B6C3F₁ mice (2 ppm) and F344/N rats (5 ppm) and squamous cell carcinomas of the lung in male and female rats (NTP, 1990).

The only other lesions associated with nitromethane exposure were nonneoplastic nasal lesions that occurred in most exposed male and female mice. These lesions were similar to those observed in the 13-week study, except that they were much more severe following 2 years of exposure to nitromethane. Nasal lesions included degeneration and metaplasia of the olfactory epithelium and hyaline degeneration of the respiratory epithelium. No neoplasms of the nasal cavity were observed in exposed male or female mice. Exposure to tetranitromethane for 2 years caused hyperplasia and metaplasia of the nasal

respiratory epithelium in male and female mice (2 ppm) and rats (5 ppm) (NTP, 1990). There was no effect of tetranitromethane exposure on the olfactory epithelium in mice or rats, and no nasal cavity neoplasms were induced by exposure to tetranitromethane.

CONCLUSIONS

Under the conditions of these 2-year inhalation studies, there was *no evidence of carcinogenic activity** of nitromethane in male F344/N rats exposed to 94, 188, or 375 ppm. There was *clear evidence of carcinogenic activity* of nitromethane in female F344/N rats based on increased incidences of mammary gland fibroadenomas and carcinomas.

There was *clear evidence of carcinogenic activity* of nitromethane in male B6C3F₁ mice based on increased incidences of harderian gland adenomas and carcinomas. There was *clear evidence of carcinogenic activity* in female B6C3F₁ mice, based on increased incidences of liver neoplasms (primarily adenomas) and harderian gland adenomas and carcinomas. Increased incidences of alveolar/bronchiolar adenomas and carcinomas in male and female mice exposed to nitromethane were also considered to be related to chemical administration.

Exposure to nitromethane by inhalation for 2 years resulted in increased incidences of nasal lesions including degeneration and metaplasia of the olfactory epithelium and degeneration of the respiratory epithelium in male and female mice.

* Explanation of Levels of Evidence of Carcinogenic Activity is on page 11. A summary of the Technical Reports Review Subcommittee comments and the public discussion on this Technical Report appears on page 13.

REFERENCES

- American Conference of Governmental Industrial Hygienists (ACGIH) (1995). *1995-1996 Threshold Limit Values (TLVs™) for Chemical Substances and Physical Agents and Biological Exposure Indices (BEIs™)*, p. 28. Cincinnati, OH.
- Andrae, U., Homfeldt, H., Vogl, L., Lichtmannegger, J., and Summer, K.H. (1988). 2-Nitropropane induces DNA repair synthesis in rat hepatocytes *in vitro* and *in vivo*. *Carcinogenesis* 9, 811-815.
- Armitage, P. (1971). *Statistical Methods in Medical Research*, pp. 362-365. John Wiley and Sons, New York.
- Ashby, J., and Tennant, R.W. (1991). Definitive relationships among chemical structure, carcinogenicity, and mutagenicity for 301 chemicals tested by the U.S. NTP. *Mutat. Res.* 257, 229-306.
- Biocides, U.S.A.* (1974). p. 156. Charles H. Kline and Company, Fairfield, NJ.
- Boorman, G.A., Montgomery, C.A., Jr., Eustis, S.L., Wolfe, M.J., McConnell, E.E., and Hardisty, J.F. (1985). Quality assurance in pathology for rodent carcinogenicity studies. In *Handbook of Carcinogen Testing* (H.A. Milman and E.K. Weisburger, Eds.), pp. 345-357. Noyes Publications, Park Ridge, NJ.
- Chiu, C.W., Lee, L.H., Wang, C.Y., and Bryan, G.T. (1978). Mutagenicity of some commercially available nitro compounds for *Salmonella typhimurium*. *Mutat. Res.* 58, 11-22.
- Code of Federal Regulations (CFR) 21, Part 58.
- Code of Federal Regulations (CFR) 29, § 1910.1000.
- Conaway, C.C., Hussain, N.S., Way, B.M., and Fiala, E.S. (1991a). Evaluation of secondary nitroalkanes, their nitronates, primary nitroalkanes, nitrocarbinols, and other aliphatic nitro compounds in the Ames Salmonella assay. *Mutat. Res.* 261, 197-207.
- Conaway, C.C., Nie, G., Hussain, N.S., and Fiala, E.S. (1991b). Comparison of oxidative damage to rat liver DNA and RNA by primary nitroalkanes, secondary nitroalkanes, cyclopentanone oxime, and related compounds. *Cancer Res.* 51, 3143-3147.
- Cox, D.R. (1972). Regression models and life-tables. *J. R. Stat. Soc.* B34, 187-220.
- Crawford, B.D. (1985). Perspectives on the somatic mutation model of carcinogenesis. In *Advances in Modern Environmental Toxicology: Mechanisms and Toxicity of Chemical Carcinogens and Mutagens* (M.A. Mehlman, W.G. Flamm, and R.J. Lorentzen, Eds.), pp. 13-59. Princeton Scientific Publishing Co., Princeton, NJ.
- Cunningham, M.L., and Matthews, H.B. (1991). Relationship of hepatocarcinogenicity and hepatocellular proliferation induced by mutagenic noncarcinogens vs carcinogens. *Toxicol. Appl. Pharmacol.* 110, 505-513.
- Dahl, A.R., and Hadley, W.M. (1983). Formaldehyde production promoted by rat nasal cytochrome P-450-dependent monooxygenases with nasal decongestants, essences, solvents, air pollutants, nicotine, and cocaine as substrates. *Toxicol. Appl. Pharmacol.* 67, 200-205.
- Davis, R.A. (1993). Aliphatic nitro, nitrate, and nitrite compounds. In *Patty's Industrial Hygiene and Toxicology* (G.D. Clayton and F.E. Clayton, Eds.), 4th ed., Vol. 2A, pp. 599-662. John Wiley and Sons, New York.

- Dayal, R., Gescher, A., Harpur, E.S., Pratt, I., and Chipman, J.K. (1989). Comparison of the hepatotoxicity in mice and the mutagenicity of three nitroalkanes. *Fundam. Appl. Toxicol.* **13**, 341-348.
- Dayal, R., Goodwin, B., Linhart, I., Mynett, K., and Gescher, A. (1991). Oxidative denitration of 2-nitropropane and propane-2-nitronate by mouse liver microsomes: Lack of correlation with hepatocytotoxic potential. *Chem.-Biol. Interact.* **79**, 103-114.
- Decker, J.R., Moss, O.R., and Kay, B.L. (1982). Controlled-delivery vapor generator for animal exposures. *Am. Ind. Hyg. Assoc. J.* **43**, 400-402.
- Deichmann, W.B., MacDonald, W.E., Anderson, W.A.D., and Bernal, E. (1963). Adenocarcinoma in the lungs of mice exposed to vapors of 3-nitro-3-hexene. *Toxicol. Appl. Pharmacol.* **5**, 445-456.
- Dellarco, V.L., and Prival, M.J. (1989). Mutagenicity of nitro compounds in *Salmonella typhimurium* in the presence of flavin mononucleotide in a pre-incubation assay. *Environ. Mol. Mutagen.* **13**, 116-127.
- Dequidt, J., Vasseur, P., and Potencier, J. (1973). Experimental toxicological study of some nitroparaffins. 4. Nitromethane. *Bull. Soc. Pharm.* **1**, 29-35.
- Dinse, G.E., and Haseman, J.K. (1986). Logistic regression analysis of incidental-tumor data from animal carcinogenicity experiments. *Fundam. Appl. Toxicol.* **6**, 44-52.
- Dinse, G.E., and Lagakos, S.W. (1983). Regression analysis of tumour prevalence data. *Appl. Statist.* **32**, 236-248.
- Dixon, W.J., and Massey, F.J., Jr. (1951). *Introduction to Statistical Analysis*, 1st ed., pp. 145-147. McGraw-Hill Book Company, New York.
- Douay, O., and Kamoun, P.P. (1980). Serotonin in experimental histidinemia. *Neurochem. Res.* **5**, 897-903.
- Dunn, O.J. (1964). Multiple comparisons using rank sums. *Technometrics* **6**, 241-252.
- Dunnett, C.W. (1955). A multiple comparison procedure for comparing several treatments with a control. *J. Am. Stat. Assoc.* **50**, 1096-1121.
- Fiala, E.S., Czerniak, R., Castonguay, A., Conaway, C.C., and Rivenson, A. (1987). Assay of 1-nitropropane, 2-nitropropane, 1-azoxypropane and 2-azoxypropane for carcinogenicity by gavage in Sprague-Dawley rats. *Carcinogenesis* **8**, 1947-1949.
- Galloway, S.M., Armstrong, M.J., Reuben, C., Colman, S., Brown, B., Cannon, C., Bloom, A.D., Nakamura, F., Ahmed, M., Duk, S., Rimpo, J., Margolin, B.H., Resnick, M.A., Anderson, B., and Zeiger, E. (1987). Chromosome aberrations and sister chromatid exchanges in Chinese hamster ovary cells: Evaluations of 108 chemicals. *Environ. Mol. Mutagen.* **10** (Suppl. 10), 1-175.
- Gart, J.J., Chu, K.C., and Tarone, R.E. (1979). Statistical issues in interpretation of chronic bioassay tests for carcinogenicity. *J. Natl. Cancer Inst.* **62**, 957-974.
- Gibbs, W., and Reichert, E.T. (1891). A systematic study of the action of definitely related chemical compounds upon animals. *Amer. Chem. J.* **13**, 361-370.
- Gocke, E., King, M.-T., Eckhardt, K., and Wild, D. (1981). Mutagenicity of cosmetics ingredients licensed by the European Communities. *Mutat. Res.* **90**, 91-109.
- Gosselin, R.E., Smith, R.P., and Hodge, H.C. (1984). *Clinical Toxicology of Commercial Products*, 5th ed., p. II-213. Williams and Wilkins, Baltimore, MD.
- Griffin, T.B., Stein, A.A., and Coulston, F. (1982). Inhalation exposure of rats to vapors of 1-nitropropane at 100 ppm. *Ecotoxicol. Environ. Safety* **6**, 268-282.

- Griffin, T.B., Stein, A.A., and Coulston, F. (1988). Chronic inhalation exposure of rats to vapors of nitroethane. *Ecotoxicol. Environ. Safety* 16, 11-24.
- Haseman, J.K. (1984). Statistical issues in the design, analysis and interpretation of animal carcinogenicity studies. *Environ. Health Perspect.* 58, 385-392.
- Hollander, M., and Wolfe, D.A. (1973). *Nonparametric Statistical Methods*, pp. 120-123. John Wiley and Sons, New York.
- The International Technical Information Institute (1979). *Toxic and Hazardous Industrial Chemicals Safety Manual for Handling and Disposal with Toxicity and Hazard Data*, pp. 373-374. Tokyo.
- Jonckheere, A.R. (1954). A distribution-free *k*-sample test against ordered alternatives. *Biometrika* 41, 133-145.
- Kaplan, E.L., and Meier, P. (1958). Nonparametric estimation from incomplete observations. *J. Am. Stat. Assoc.* 53, 457-481.
- Kirk-Othmer Encyclopedia of Chemical Technology* (1978). 3rd ed., Vol. 1, pp. 961-967. John Wiley and Sons, New York.
- Kirk-Othmer Encyclopedia of Chemical Technology* (1981). 3rd ed., Vol. 15, pp. 910-916 and 969-987. John Wiley and Sons, New York.
- Kuo, C.F., and Fridovich, I. (1986). Free-radical chain oxidation of 2-nitropropane initiated and propagated by superoxide. *Biochem. J.* 237, 505-510.
- Lewis, T.R., Ulrich, C.E., and Busey, W.M. (1979). Subchronic inhalation toxicity of nitromethane and 2-nitropropane. *J. Environ. Pathol. Toxicol.* 2, 233-249.
- Löfroth, G., Nilsson, L., and Andersen, J.R. (1986). Structure-activity relationship of nitroalkane-induced mutagenicity in the Ames Salmonella assay. *Prog. Clin. Biol. Res.* 209B, 149-155.
- McConnell, E.E., Solleveld, H.A., Swenberg, J.A., and Boorman, G.A. (1986). Guidelines for combining neoplasms for evaluation of rodent carcinogenesis studies. *JNCI* 76, 283-289.
- MacGregor, J.T., Wehr, C.M., and Langlois, R.G. (1983). A simple fluorescent staining procedure for micronuclei and RNA in erythrocytes using Hoescht 33258 and pyronin Y. *Mutat. Res.* 120, 269-275.
- MacGregor, J.T., Wehr, C.M., Henika, P.R., and Shelby, M.D. (1990). The *in vivo* erythrocyte micronucleus test: Measurement at steady state increases assay efficiency and permits integration with toxicity studies. *Fundam. Appl. Toxicol.* 14, 513-522.
- Machle, W., Scott, E.W., and Treon, J. (1940). The physiological response of animals to some simple mononitroparaffins and to certain derivatives of these compounds. *J. Ind. Hyg. Toxicol.* 22, 315-332.
- McKnight, B., and Crowley, J. (1984). Tests for differences in tumor incidence based on animal carcinogenesis experiments. *J. Am. Stat. Assoc.* 79, 639-648.
- Margolin, B.H., Risko, K.J., Frome, E.L., and Tice, R.R. (1990). A general purpose statistical analysis program for micronucleus assay data. Appendix 2: Micronucleus data management and analysis version 1.4a. Integrated Laboratory Systems, Research Triangle Park, NC.
- Marker, E.K., and Kulkarni, A.P. (1986). Cytochrome P-450-mediated denitrication of 2-nitropropane in mouse liver microsomes. *J. Biochem. Toxicol.* 1, 71-83.
- Maronpot, R.R., and Boorman, G.A. (1982). Interpretation of rodent hepatocellular proliferative alterations and hepatocellular tumors in chemical safety assessment. *Toxicol. Pathol.* 10, 71-80.
- The Merck Index* (1983). 10th ed. (M. Windholz, Ed.), p. 6464. Merck and Company, Rahway, NJ.
- The Merck Index* (1989). 11th ed. (S. Budavari, Ed.), p. 1046. Merck and Company, Rahway, NJ.

- Miller, J.A., and Miller, E.C. (1977). Ultimate chemical carcinogens as reactive mutagenic electrophiles. In *Origins of Human Cancer* (H.H. Hiatt, J.D. Watson, and J.A. Winsten, Eds.), pp. 605-627. Cold Spring Harbor Laboratory, Cold Spring Harbor, NY.
- Morrison, D.F. (1976). *Multivariate Statistical Methods*, 2nd ed., pp. 170-179. McGraw-Hill Book Company, New York.
- Mortelmans, K., Haworth, S., Lawlor, T., Speck, W., Tainer, B., and Zeiger, E. (1986). *Salmonella* mutagenicity tests: II. Results from the testing of 270 chemicals. *Environ. Mutagen.* 8 (Suppl. 7), 1-119.
- National Cancer Institute (NCI) (1976). Guidelines for Carcinogen Bioassay in Small Rodents. Technical Report Series No. 1. NIH Publication No. 76-801. U.S. Department of Health, Education, and Welfare, Public Health Service, National Institutes of Health, Bethesda, MD.
- National Institute for Occupational Safety and Health (NIOSH) (1990). National Occupational Exposure Survey (1981-1983); unpublished provisional data as of July 1, 1990. NIOSH, Cincinnati, OH.
- National Institutes of Health (NIH) (1978). Open Formula Rat and Mouse Ration (NIH-07). Specification NIH-11-1335. U.S. Department of Health, Education, and Welfare, Public Health Service, National Institutes of Health, Bethesda, MD.
- National Library of Medicine (1995a). Hazardous Substances Data Bank. Database maintained by the National Library of Medicine, available through the MEDLARS system. U.S. Department of Health and Human Services, Public Health Service, National Institutes of Health, Bethesda, MD.
- National Library of Medicine (1995b). MEDLINE, CANCERLIT, TOXLINE. Toxicology Data Bank databases maintained by the National Library of Medicine. U.S. Department of Health and Human Services, Public Health Service, National Institutes of Health, Bethesda, MD.
- National Toxicology Program (NTP) (1987). Technical Protocol for Sperm Morphology and Vaginal Cytology Evaluations in Toxicity Testing for Rats and Mice, 10/31/82 version (updated December 1987). Research Triangle Park, NC.
- National Toxicology Program (NTP) (1990). Toxicology and Carcinogenesis Studies of Tetranitromethane (CAS No. 509-14-8) in F344/N Rats and B6C3F₁ Mice (Inhalation Studies). Technical Report Series No. 386. NIH Publication No. 90-2841. U.S. Department of Health and Human Services, Public Health Service, National Institutes of Health, Research Triangle Park, NC.
- National Toxicology Program (NTP) (1994). Seventh Annual Report on Carcinogens. Summary 1994, pp. 275, 376. U.S. Department of Health and Human Services, Public Health Service, National Institutes of Health, Research Triangle Park, NC.
- Porter, D.J.T., Voet, J.G., and Bright, H.J. (1972). Nitromethane. A novel substrate for D-amino acid oxidase. *J. Biol. Chem.* 247, 1951-1953.
- Remington's Pharmaceutical Sciences* (1975). 15th ed. (J.E. Hoover, Ed.), p. 773. Mack Publishing Company, Easton, PA.
- Riordan, J.F., and Vallee, B.L. (1972). Nitration with tetranitromethane. *Methods Enzymol.* 25, 515-521.
- Sadtler Standard Spectra*. IR No. 61 (Midget Edition); UV No. 29; NMR No. 9146M. Sadtler Research Laboratories, Philadelphia, PA.
- Sakurai, H., Hermann, G., Ruf, H.H., and Ullrich, V. (1980). The interaction of aliphatic nitro compounds with the liver microsomal monooxygenase system. *Biochem. Pharmacol.* 29, 341-345.
- Schmid, W. (1976). The micronucleus test for cytogenic analysis. In *Chemical Mutagens, Principles and Methods for Their Detection* (A. Hollaender, Ed.), Vol. 4, pp. 31-53. Plenum Press, New York.

- Seilkop, S.K. (1995). The effect of body weight on tumor incidence and carcinogenicity testing in B6C3F₁ mice and F344 rats. *Fundam. Appl. Toxicol.* 24, 247-259.
- Shirley, E. (1977). A non-parametric equivalent of Williams' test for contrasting increasing dose levels of a treatment. *Biometrics* 33, 386-389.
- SRI, International (1980). *Chemical Economics Handbook*, pp. 573.9001C,P. Menlo Park, CA.
- Straus, D.S. (1981). Somatic mutation, cellular differentiation, and cancer causation. *JNCI* 67, 233.
- Subbotin, V.G. (1967). Hygienic assessment of nitromethane and other nitroparafins in connection with sanitary protection of water bodies [in Russian, English summary]. *Gig. Sanit.* 32, 9-13.
- Tarone, R.E. (1975). Tests for trend in life table analysis. *Biometrika* 62, 679-682.
- Tennant, R.W., and Ashby, J. (1991). Classification according to chemical structure, mutagenicity to Salmonella and level of carcinogenicity of a further 39 chemicals tested for carcinogenicity by the U.S. National Toxicology Program. *Mutat. Res.* 257, 209-227.
- Tennant, R.W., Margolin, B.H., Shelby, M.D., Zeiger, E., Haseman, J.K., Spalding, J., Caspary, W., Resnick, M., Stasiewicz, S., Anderson, B., and Minor, R. (1987). Prediction of chemical carcinogenicity in rodents from *in vitro* genetic toxicity assays. *Science* 236, 933-941.
- Ullrich, V., Hermann, G., and Weber, P. (1978). Nitrite formation from 2-nitropropane by microsomal monooxygenases. *Biochem. Pharmacol.* 27, 2301-2304.
- U.S. International Trade Commission (USITC) (1994). Synthetic Organic Chemicals. United States Production and Sales, 1992, p. 3-28. USITC Publication 2720. Washington, DC.
- Wade, A.E., Evans, J.S., Sternson, L.A., and Gammans, R.E. (1977). Interaction of nitromethane with reduced hepatic microsomal cytochrome P-450. *Biochem. Pharmacol.* 26, 963-967.
- Weatherby, J.H. (1955). Observations on the toxicity of nitromethane. *AMA Arch. Ind. Health* 11, 102-106.
- Williams, D.A. (1971). A ³ test for differences between treatment means when several dose levels are compared with a zero dose control. *Biometrics* 27, 103-117.
- Williams, D.A. (1972). The comparison of several dose levels with a zero dose control. *Biometrics* 28, 519-531.
- Zeiger, E., Haseman, J.K., Shelby, M.D., Margolin, B.H., and Tennant, R.W. (1990). Evaluation of four *in vitro* genetic toxicity tests for predicting rodent carcinogenicity: Confirmation of earlier results with 41 additional chemicals. *Environ. Mol. Mutagen.* 16 (Suppl. 18), 1-14.
- Zitting, A., Nickels, J., and Savolainen, H. (1982). Comparison of acute toxic effects of intraperitoneally injected nitromethane and nitroethane in rats. *Toxicol. Lett.* 13, 189-194.

APPENDIX A
SUMMARY OF LESIONS IN MALE RATS
IN THE 2-YEAR INHALATION STUDY
OF NITROMETHANE

TABLE A1	Summary of the Incidence of Neoplasms in Male Rats in the 2-Year Inhalation Study of Nitromethane	76
TABLE A2	Individual Animal Tumor Pathology of Male Rats in the 2-Year Inhalation Study of Nitromethane	80
TABLE A3	Statistical Analysis of Primary Neoplasms in Male Rats in the 2-Year Inhalation Study of Nitromethane	104
TABLE A4	Summary of the Incidence of Nonneoplastic Lesions in Male Rats in the 2-Year Inhalation Study of Nitromethane	111

TABLE A1
Summary of the Incidence of Neoplasms in Male Rats in the 2-Year Inhalation Study of Nitromethane^a

	0 ppm	94 ppm	188 ppm	375 ppm
Disposition Summary				
Animals initially in study	50	50	50	50
Early deaths				
Moribund	33	31	34	39
Natural deaths	4	3	2	3
Survivors				
Terminal sacrifice	13	16	14	8
Animals examined microscopically	50	50	50	50
Alimentary System				
Intestine large, colon	(50)	(50)	(50)	(50)
Intestine large, rectum	(50)	(49)	(50)	(49)
Intestine large, cecum	(50)	(50)	(50)	(50)
Intestine small, duodenum	(50)	(50)	(50)	(49)
Histiocytic sarcoma		1 (2%)		
Intestine small, jejunum	(50)	(50)	(50)	(50)
Intestine small, ileum	(50)	(50)	(50)	(50)
Histiocytic sarcoma		1 (2%)		
Liver	(50)	(50)	(50)	(50)
Cholangiocarcinoma	1 (2%)			
Hepatocellular carcinoma			2 (4%)	
Hepatocellular adenoma	1 (2%)	1 (2%)		2 (4%)
Hepatocellular adenoma, multiple			1 (2%)	
Histiocytic sarcoma	1 (2%)	1 (2%)		
Mesentery	(15)	(13)	(10)	(8)
Oral mucosa	(1)	(2)	(1)	
Pharyngeal, squamous cell papilloma		1 (50%)	1 (100%)	
Pancreas	(50)	(50)	(50)	(50)
Adenoma	1 (2%)	1 (2%)	1 (2%)	
Histiocytic sarcoma		1 (2%)		
Salivary glands	(50)	(50)	(50)	(50)
Stomach, forestomach	(50)	(50)	(50)	(50)
Histiocytic sarcoma		1 (2%)		
Stomach, glandular	(50)	(50)	(50)	(50)
Histiocytic sarcoma		1 (2%)		
Tongue		(1)		(1)
Squamous cell carcinoma		1 (100%)		
Squamous cell papilloma				1 (100%)
Cardiovascular System				
Heart	(50)	(50)	(50)	(50)
Schwannoma malignant	1 (2%)			
Endocrine System				
Adrenal cortex	(50)	(50)	(50)	(50)
Carcinoma				1 (2%)
Carcinoma, metastatic, Zymbal's gland				1 (2%)
Pheochromocytoma malignant, metastatic, adrenal medulla		1 (2%)		

TABLE A1
Summary of the Incidence of Neoplasms in Male Rats in the 2-Year Inhalation Study of Nitromethane (continued)

	0 ppm	94 ppm	188 ppm	375 ppm
Endocrine System (continued)				
Adrenal medulla	(50)	(50)	(50)	(50)
Carcinoma, metastatic, Zymbal's gland				1 (2%)
Pheochromocytoma malignant		1 (2%)	2 (4%)	2 (4%)
Pheochromocytoma benign	11 (22%)	12 (24%)	15 (30%)	14 (28%)
Bilateral, pheochromocytoma malignant	1 (2%)			
Bilateral, pheochromocytoma benign	5 (10%)	8 (16%)	6 (12%)	5 (10%)
Islets, pancreatic	(50)	(50)	(50)	(50)
Adenoma	8 (16%)	9 (18%)	4 (8%)	1 (2%)
Carcinoma	1 (2%)	1 (2%)	3 (6%)	5 (10%)
Parathyroid gland	(47)	(49)	(49)	(48)
Adenoma		1 (2%)	1 (2%)	
Pituitary gland	(50)	(47)	(50)	(49)
Histiocytic sarcoma		1 (2%)		
Pars distalis, adenoma	38 (76%)	36 (77%)	32 (64%)	39 (80%)
Pars intermedia, adenoma			1 (2%)	2 (4%)
Thyroid gland	(50)	(50)	(50)	(50)
Bilateral, C-cell, carcinoma		1 (2%)		
C-cell, adenoma	8 (16%)	5 (10%)	8 (16%)	8 (16%)
C-cell, carcinoma		1 (2%)	1 (2%)	3 (6%)
Follicular cell, adenoma		1 (2%)		
Follicular cell, carcinoma	1 (2%)	1 (2%)	2 (4%)	
General Body System				
Peritoneum		(1)		(1)
Genital System				
Epididymis	(50)	(50)	(50)	(50)
Preputial gland	(50)	(50)	(50)	(50)
Adenoma	4 (8%)	3 (6%)	3 (6%)	3 (6%)
Carcinoma		1 (2%)	1 (2%)	1 (2%)
Prostate	(50)	(50)	(50)	(50)
Seminal vesicle	(50)	(50)	(50)	(50)
Histiocytic sarcoma		1 (2%)		
Testes	(50)	(50)	(50)	(50)
Bilateral, interstitial cell, adenoma	22 (44%)	23 (46%)	27 (54%)	16 (32%)
Interstitial cell, adenoma	16 (32%)	11 (22%)	13 (26%)	15 (30%)
Hematopoietic System				
Bone marrow	(50)	(50)	(50)	(50)
Histiocytic sarcoma	1 (2%)	1 (2%)		
Lymph node	(17)	(13)	(17)	(13)
Deep cervical, carcinoma, metastatic, thyroid gland		1 (8%)		
Iliac, histiocytic sarcoma		1 (8%)		
Renal, histiocytic sarcoma		1 (8%)		

TABLE A1
Summary of the Incidence of Neoplasms in Male Rats in the 2-Year Inhalation Study of Nitromethane (continued)

	0 ppm	94 ppm	188 ppm	375 ppm
Hematopoietic System (continued)				
Lymph node, bronchial	(48)	(48)	(48)	(47)
Osteosarcoma, metastatic, bone		1 (2%)		
Lymph node, mandibular	(48)	(48)	(48)	(49)
Histiocytic sarcoma		1 (2%)		
Lymph node, mesenteric	(50)	(50)	(48)	(50)
Histiocytic sarcoma		1 (2%)		
Lymph node, mediastinal	(50)	(45)	(50)	(47)
Histiocytic sarcoma		1 (2%)		
Spleen	(50)	(50)	(50)	(50)
Fibroma	1 (2%)	1 (2%)		
Histiocytic sarcoma		1 (2%)		
Thymus	(45)	(45)	(48)	(46)
Histiocytic sarcoma		1 (2%)		
Thymoma benign			1 (2%)	
Integumentary System				
Mammary gland	(28)	(27)	(31)	(28)
Fibroadenoma	1 (4%)	1 (4%)	1 (3%)	2 (7%)
Skin	(50)	(49)	(50)	(50)
Basal cell carcinoma				2 (4%)
Keratoacanthoma	6 (12%)	2 (4%)	2 (4%)	1 (2%)
Keratoacanthoma, multiple				1 (2%)
Squamous cell carcinoma	1 (2%)	2 (4%)	1 (2%)	1 (2%)
Squamous cell papilloma				3 (6%)
Sebaceous gland, adenoma	1 (2%)	1 (2%)		
Subcutaneous tissue, fibroma	3 (6%)		1 (2%)	
Subcutaneous tissue, fibrosarcoma	3 (6%)			
Subcutaneous tissue, lipoma				1 (2%)
Subcutaneous tissue, osteosarcoma			1 (2%)	
Subcutaneous tissue, sarcoma			2 (4%)	
Subcutaneous tissue, schwannoma malignant				2 (4%)
Musculoskeletal System				
Bone	(50)	(50)	(50)	(50)
Histiocytic sarcoma	1 (2%)			
Osteoma	1 (2%)			
Osteosarcoma		1 (2%)		
Skeletal muscle	(2)		(1)	(1)
Histiocytic sarcoma	1 (50%)			
Nervous System				
Brain	(50)	(50)	(50)	(50)
Granular cell tumor benign				1 (2%)
Oligodendroglioma benign		1 (2%)		

TABLE A1
Summary of the Incidence of Neoplasms in Male Rats in the 2-Year Inhalation Study of Nitromethane (continued)

	0 ppm	94 ppm	188 ppm	375 ppm
Respiratory System				
Larynx	(50)	(50)	(50)	(50)
Lung	(50)	(50)	(50)	(50)
Alveolar/bronchiolar adenoma	1 (2%)	2 (4%)		3 (6%)
Alveolar/bronchiolar carcinoma			2 (4%)	
Carcinoma, metastatic, thyroid gland		1 (2%)		
Carcinoma, metastatic, Zymbal's gland				1 (2%)
Cholangiocarcinoma, metastatic, liver	1 (2%)			
Histiocytic sarcoma	1 (2%)	1 (2%)		
Osteosarcoma, metastatic, bone		1 (2%)		
Pheochromocytoma malignant, metastatic, adrenal medulla	1 (2%)			
Squamous cell carcinoma, metastatic, skin			1 (2%)	
Nose	(50)	(50)	(50)	(50)
Special Senses System				
Harderian gland	(1)			
Zymbal's gland		(2)		(1)
Carcinoma		2 (100%)		1 (100%)
Urinary System				
Kidney	(50)	(50)	(50)	(50)
Carcinoma, metastatic, Zymbal's gland				1 (2%)
Histiocytic sarcoma	1 (2%)	1 (2%)		
Lipoma			1 (2%)	
Renal tubule, adenoma		3 (6%)	2 (4%)	1 (2%)
Urinary bladder	(50)	(50)	(50)	(50)
Histiocytic sarcoma		1 (2%)		
Transitional epithelium, papilloma		1 (2%)		
Systemic Lesions				
Multiple organs ^b	(50)	(50)	(50)	(50)
Histiocytic sarcoma	1 (2%)	1 (2%)		
Leukemia mononuclear	35 (70%)	27 (54%)	33 (66%)	25 (50%)
Mesothelioma malignant	1 (2%)	3 (6%)		1 (2%)
Neoplasm Summary				
Total animals with primary neoplasms ^c	50	49	50	49
Total primary neoplasms	174	167	171	163
Total animals with benign neoplasms	50	45	50	47
Total benign neoplasms	128	124	121	119
Total animals with malignant neoplasms	40	35	39	33
Total malignant neoplasms	46	43	50	44
Total animals with metastatic neoplasms	2	3	1	1
Total metastatic neoplasms	2	5	1	4

^a Number of animals examined microscopically at the site and the number of animals with neoplasm

^b Number of animals with any tissue examined microscopically

^c Primary neoplasms: all neoplasms except metastatic neoplasms

TABLE A2
Individual Animal Tumor Pathology of Male Rats in the 2-Year Inhalation Study of Nitromethane: 0 ppm

	2	4	4	4	5	5	5	5	5	5	5	5	5	5	6	6	6	6	6	6	6	6	6	6	6	
Number of Days on Study	4	1	9	9	0	1	2	3	5	6	6	8	9	9	0	1	1	1	2	2	4	4	6	6	6	
	2	1	0	1	4	2	8	7	2	5	9	0	0	2	0	1	1	2	3	6	4	4	0	4	4	
Carcass ID Number	0	0	0	0	0	0	0	0	0	0	0	0	0	0	0	0	0	0	0	0	0	0	0	0	0	
	3	4	2	2	0	1	4	3	2	4	1	1	1	1	3	0	0	1	0	4	4	5	2	0	3	
	5	3	0	2	1	7	7	8	3	9	3	2	6	5	7	7	9	1	5	2	1	0	1	6	2	
Alimentary System																										
Esophagus	+	+	+	+	+	+	+	+	+	+	+	+	+	+	+	+	+	+	+	+	+	+	+	+	+	
Intestine large, colon	+	+	+	+	+	+	+	+	+	+	+	+	+	+	+	+	+	+	+	+	+	+	+	+	+	
Intestine large, rectum	+	+	+	+	+	+	+	+	+	+	+	+	+	+	+	+	+	+	+	+	+	+	+	+	+	
Intestine large, cecum	+	+	+	+	+	+	+	+	+	+	+	+	+	+	+	+	+	+	+	+	+	+	+	+	+	
Intestine small, duodenum	+	+	+	+	+	+	+	+	+	+	+	+	+	+	+	+	+	+	+	+	+	+	+	+	+	
Intestine small, jejunum	+	+	+	+	+	+	+	+	+	+	+	+	+	+	+	+	+	+	+	+	+	+	+	+	+	
Intestine small, ileum	+	+	+	+	+	+	+	+	+	+	+	+	+	+	+	+	+	+	+	+	+	+	+	+	+	
Liver	+	+	+	+	+	+	+	+	+	+	+	+	+	+	+	+	+	+	+	+	+	+	+	+	+	
Cholangiocarcinoma																										
Hepatocellular adenoma							X																			
Histiocytic sarcoma																										
Mesentery			+								+		+			+					+	+			+	
Oral mucosa																										
Pancreas	+	+	+	+	+	+	+	+	+	+	+	+	+	+	+	+	+	+	+	+	+	+	+	+	+	
Adenoma																										
Salivary glands	+	+	+	+	+	+	+	+	+	+	+	+	+	+	+	+	+	+	+	+	+	+	+	+	+	
Stomach, forestomach	+	+	+	+	+	+	+	+	+	+	+	+	+	+	+	+	+	+	+	+	+	+	+	+	+	
Stomach, glandular	+	+	+	+	+	+	+	+	+	+	+	+	+	+	+	+	+	+	+	+	+	+	+	+	+	
Tooth																										
Cardiovascular System																										
Heart	+	+	+	+	+	+	+	+	+	+	+	+	+	+	+	+	+	+	+	+	+	+	+	+	+	
Schwannoma malignant																										
Endocrine System																										
Adrenal cortex	+	+	+	+	+	+	+	+	+	+	+	+	+	+	+	+	+	+	+	+	+	+	+	+	+	
Adrenal medulla	+	+	+	+	+	+	+	+	+	+	+	+	+	+	+	+	+	+	+	+	+	+	+	+	+	
Pheochromocytoma benign																										
Bilateral, pheochromocytoma malignant																										
Bilateral, pheochromocytoma benign																										
Islets, pancreatic	+	+	+	+	+	+	+	+	+	+	+	+	+	+	+	+	+	+	+	+	+	+	+	+	+	
Adenoma																										
Carcinoma																										
Parathyroid gland	+	+	+	+	+	+	+	+	+	+	+	+	+	+	+	+	+	+	+	+	+	+	+	+	+	
Pituitary gland	+	+	+	+	+	+	+	+	+	+	+	+	+	+	+	+	+	+	+	+	+	+	+	+	+	
Pars distalis, adenoma	X	X		X	X	X	X	X	X	X	X	X	X	X	X	X	X	X	X	X	X	X	X	X	X	
Thyroid gland	+	+	+	+	+	+	+	+	+	+	+	+	+	+	+	+	+	+	+	+	+	+	+	+	+	
C-cell, adenoma																										
Follicular cell, carcinoma																										
General Body System																										
None																										
Genital System																										
Epididymis	+	+	+	+	+	+	+	+	+	+	+	+	+	+	+	+	+	+	+	+	+	+	+	+	+	
Penis																										
Preputial gland	+	+	+	+	+	+	+	+	+	+	+	+	+	+	+	+	+	+	+	+	+	+	+	+	+	
Adenoma																										

+: Tissue examined microscopically
 A: Autolysis precludes examination

M: Missing tissue
 I: Insufficient tissue

X: Lesion present
 Blank: Not examined

TABLE A2 Individual Animal Tumor Pathology of Male Rats in the 2-Year Inhalation Study of Nitroethane: @ ppm (continued)

Table with 4 columns: Number of Days on Study, Carcass ID Number, Total Tissues/Tumors, and various organ systems (Alimentary System, Cardiovascular System, Endocrine System, General Body System, Genital System). Rows list specific lesions like Intestine large, colon; Adrenal cortex; Parathyroid gland, etc., with '+' or 'X' symbols.

TABLE A2
Individual Animal Tumor Pathology of Male Rats in the 2-Year Inhalation Study of Nitromethane: 0 ppm (continued)

Number of Days on Study	6 6 6 6 6 7 7 7 7 7 7 7 7 7 7 7 7 7 7 7 7 7 7	
	7 7 8 8 9 0 1 2 2 2 2 3 3 3 3 3 3 3 3 3 3 3 3	
	0 3 1 4 2 8 9 0 0 5 7 0 3 3 3 3 4 4 5 5 5 5 5	
Carcass ID Number	0 0	Total
	4 4 3 2 0 4 2 0 4 3 2 1 0 0 2 4 1 2 1 1 2 3 3 3	Tissues/
	8 4 4 9 3 0 4 4 6 3 7 9 2 8 6 5 0 8 4 8 5 0 1 6 9	Tumors
Special Senses System		
Eye		2
Harderian gland		1
Urinary System		
Kidney	+ +	50
Histiocytic sarcoma		1
Urinary bladder	+ +	50
Systemic Lesions		
Multiple organs	+ +	50
Histiocytic sarcoma		1
Leukemia mononuclear	X X X X X X X X X X X X X X X X X X	35
Mesothelioma malignant		1

TABLE A2 Individual Animal Tumor Pathology of Male Rats in the 2-Year Inhalation Study of Nitromethane: 94 ppm (continued)

Table with columns for 'Number of Days on Study' (6-9), 'Carcass ID Number' (1-2), and various tumor types across organs like Alimentary System, Cardiovascular System, and Endocrine System. Includes a 'Total Tissues/Tumors' column.

TABLE A2
Individual Animal Tumor Pathology of Male Rats in the 2-Year Inhalation Study of Nitromethane: 94 ppm (continued)

Number of Days on Study	6 6 6 6 6 6 6 6 6 7																													
	5 6 6 6 7 7 8 9 1 3																													
	0 4 5 5 0 7 6 2 4 3 3 3 3 3 3 4 4 4 4 4 5 5 5 5 5																													
Carcass ID Number	2 2																											Total Tissues/ Tumors		
	1 1 0 2 3 2 2 4 4 1 3 4 4 4 5 0 3 3 4 4 0 1 1 1 2																													
	0 6 8 8 1 4 9 9 2 1 5 3 4 7 0 1 8 9 0 6 5 2 5 8 1																													
Integumentary System																														
Mammary gland																														
Fibroadenoma	+	+	+	+	+	M	+	M	+	M	+	M	M	+	+	+	+	+	M	+	+	M	+	+	+	+	+	+		27
Skin	+	+	+	+	+	+	+	+	+	+	+	+	+	+	+	+	+	+	+	+	+	+	+	+	+	+	+	+	+	49
Keratoacanthoma	X														X														2	
Squamous cell carcinoma																		X			X								2	
Sebaceous gland, adenoma																		X											1	
Musculoskeletal System																														
Bone																														
Osteosarcoma	+	+	+	+	+	+	+	+	+	+	+	+	+	+	+	+	+	+	+	+	+	+	+	+	+	+	+	+	+	50
																														1
Nervous System																														
Brain																														
Oligodendroglioma benign	+	+	+	+	+	+	+	+	+	+	+	+	+	+	+	+	+	+	+	+	+	+	+	+	+	+	+	+	+	50
																														1
Respiratory System																														
Larynx																														
	+	+	+	+	+	+	+	+	+	+	+	+	+	+	+	+	+	+	+	+	+	+	+	+	+	+	+	+	+	50
Lung																														
Alveolar/bronchiolar adenoma																			X										2	
Carcinoma, metastatic, thyroid gland																										X				1
Histiocytic sarcoma					X																									1
Osteosarcoma, metastatic, bone																														1
Nose																														
	+	+	+	+	+	+	+	+	+	+	+	+	+	+	+	+	+	+	+	+	+	+	+	+	+	+	+	+	+	50
Trachea																														
	+	+	+	+	+	+	+	+	+	+	+	+	+	+	+	+	+	+	+	+	+	+	+	+	+	+	+	+	+	50
Special Senses System																														
Eye																														
Zymbal's gland																														1
Carcinoma																														2
Urinary System																														
Kidney																														
Histiocytic sarcoma					X																									1
Renal tubule, adenoma										X																X				3
Urinary bladder																														
Histiocytic sarcoma	+	+	+	+	+	+	+	+	+	+	+	+	+	+	+	+	+	+	+	+	+	+	+	+	+	+	+	+	+	50
Transitional epithelium, papilloma					X																									1
Systemic Lesions																														
Multiple organs																														
Histiocytic sarcoma					X																									1
Leukemia mononuclear	X	X	X		X	X		X	X	X	X	X	X	X	X	X	X	X	X	X	X	X	X	X	X	X	X	X	X	27
Mesothelioma malignant																														3

TABLE A2
Individual Animal Tumor Pathology of Male Rats in the 2-Year Inhalation Study of Nitromethane: 188 ppm (continued)

Table with columns: Number of Days on Study, Carcass ID Number, and various organ systems (Genital, Hematopoietic, Integumentary, Musculoskeletal, Nervous, Respiratory, Special Senses) with corresponding tumor findings and counts.

TABLE A2
Individual Animal Tumor Pathology of Male Rats in the 2-Year Inhalation Study of Nitromethane: 375 ppm

Table with columns for study parameters and rows for various organ systems (Alimentary, Cardiovascular, Endocrine, General Body, Genital) and their associated tumor types. Data is represented by '+' for presence and 'X' for absence.

TABLE A2 Individual Animal Tumor Pathology of Male Rats in the 2-Year Inhalation Study of Nitromethane: 375 ppm (continued)

Table with columns for various organs and systems (Alimentary, Cardiovascular, Endocrine, General Body, Genital) and rows for individual animals (1-33). It includes counts of lesions, tumor types (e.g., Hepatocellular adenoma, Carcinoma), and a 'Total Tissues/Tumors' column on the right.

TABLE A2
Individual Animal Tumor Pathology of Male Rats in the 2-Year Inhalation Study of Nitromethane: 375 ppm (continued)

Number of Days on Study	4 4 4 4 4 5 5 5 5 5 5 5 5 6 6 6 6 6 6 6 6 6 6 6
	0 2 4 8 9 1 4 5 7 7 8 9 9 0 0 1 1 3 3 3 3 4 5 5 5
	5 8 4 0 5 6 4 1 1 3 8 0 5 7 8 2 7 0 4 6 8 3 0 0 6
Carcass ID Number	6 6
	1 3 2 4 5 2 0 4 4 2 1 0 3 0 4 3 3 2 3 4 0 2 2 4 3
	6 8 4 1 0 6 2 5 9 3 5 3 0 9 3 5 9 9 2 6 7 2 5 8 1
Special Senses System	
Eye	
Zymbal's gland	+
Carcinoma	X
Urinary System	
Kidney	+
Carcinoma, metastatic, Zymbal's gland	X
Renal tubule, adenoma	
Urinary bladder	+
Systemic Lesions	
Multiple organs	+
Leukemia mononuclear	X X
Mesothelioma malignant	

TABLE A2
Individual Animal Tumor Pathology of Male Rats in the 2-Year Inhalation Study of Nitromethane: 375 ppm (continued)

Number of Days on Study	6 6 6 6 6 6 6 6 6 6 6 6 7 7 7 7 7 7 7 7 7 7 7 7	
	6 6 7 8 8 8 8 9 9 9 9 0 0 0 0 1 3 3 3 3 3 3 3 3	
	0 4 5 1 1 3 8 2 2 8 8 0 0 5 9 9 2 3 3 3 4 4 4 5 5	
Carcass ID Number	6 6	Total
	1 0 1 0 1 2 1 1 4 0 3 0 3 4 2 4 3 1 1 2 1 2 4 0 3	Tissues/
	9 4 0 8 1 8 2 3 7 5 3 1 4 4 7 0 7 4 7 0 8 1 2 6 6	Tumors
Special Senses System		
Eye		1
Zymbal's gland		1
Carcinoma		1
Urinary System		
Kidney	+ +	50
Carcinoma, metastatic, Zymbal's gland		1
Renal tubule, adenoma		1
Urinary bladder	+ +	50
Systemic Lesions		
Multiple organs	+ +	50
Leukemia mononuclear	X X X X X X X X X X X X X X X	25
Mesothelioma malignant		1

TABLE A3
Statistical Analysis of Primary Neoplasms in Male Rats in the 2-Year Inhalation Study of Nitromethane

	0 ppm	94 ppm	188 ppm	375 ppm
Adrenal Medulla: Benign Pheochromocytoma				
Overall rate ^a	16/50 (32%)	20/50 (40%)	21/50 (42%)	19/50 (38%)
Adjusted rate ^b	71.6%	72.9%	77.2%	70.4%
Terminal rate ^c	7/13 (54%)	9/16 (56%)	9/14 (64%)	2/8 (25%)
First incidence (days)	611	574	499	544
Life table test ^d	P=0.098	P=0.338	P=0.239	P=0.101
Logistic regression test ^d	P=0.302	P=0.141	P=0.167	P=0.260
Cochran-Armitage test ^d	P=0.346			
Fisher exact test ^d		P=0.266	P=0.204	P=0.338
Adrenal Medulla: Benign or Malignant Pheochromocytoma				
Overall rate	17/50 (34%)	21/50 (42%)	22/50 (44%)	20/50 (40%)
Adjusted rate	76.3%	76.8%	78.0%	72.2%
Terminal rate	8/13 (62%)	10/16 (63%)	9/14 (64%)	2/8 (25%)
First incidence (days)	611	574	499	544
Life table test	P=0.093	P=0.352	P=0.243	P=0.094
Logistic regression test	P=0.301	P=0.129	P=0.168	P=0.254
Cochran-Armitage test	P=0.348			
Fisher exact test		P=0.268	P=0.206	P=0.339
Kidney (Renal Tubule): Adenoma (Single Sections)				
Overall rate	0/50 (0%)	3/50 (6%)	2/50 (4%)	1/50 (2%)
Adjusted rate	0.0%	14.9%	14.3%	12.5%
Terminal rate	0/13 (0%)	1/16 (6%)	2/14 (14%)	1/8 (13%)
First incidence (days)	— ^e	636	733 (T)	733 (T)
Life table test	P=0.399	P=0.125	P=0.252	P=0.403
Logistic regression test	P=0.487	P=0.107	P=0.252	P=0.403
Cochran-Armitage test	P=0.555			
Fisher exact test		P=0.121	P=0.247	P=0.500
Kidney (Renal Tubule): Adenoma (Step Sections)				
Overall rate	2/50 (4%)	2/50 (4%)	0/50 (0%)	4/50 (6%)
Adjusted rate	15.4%	12.5%	0.0%	22.7%
Terminal rate	2/13 (15%)	2/16 (13%)	0/14 (0%)	1/8 (13%)
First incidence (days)	733 (T)	733 (T)	—	650
Life table test	P=0.129	P=0.622N	P=0.219N	P=0.223
Logistic regression test	P=0.184	P=0.622N	P=0.219N	P=0.283
Cochran-Armitage test	P=0.233			
Fisher exact test		P=0.691N	P=0.247N	P=0.339
Kidney (Renal Tubule): Adenoma (Single and Step Sections)				
Overall rate	2/50 (4%)	5/50 (10%)	2/50 (4%)	5/50 (10%)
Adjusted rate	15.4%	26.3%	14.3%	33.7%
Terminal rate	2/13 (15%)	3/16 (19%)	2/14 (14%)	2/8 (25%)
First incidence (days)	733 (T)	636	733 (T)	650
Life table test	P=0.104	P=0.264	P=0.675N	P=0.112
Logistic regression test	P=0.181	P=0.173	P=0.675N	P=0.158
Cochran-Armitage test	P=0.256			
Fisher exact test		P=0.218	P=0.691N	P=0.218

TABLE A3

Statistical Analysis of Primary Neoplasms in Male Rats in the 2-Year Inhalation Study of Nitromethane (continued)

	0 ppm	94 ppm	188 ppm	375 ppm
Liver: Hepatocellular Adenoma or Carcinoma				
Overall rate	1/50 (2%)	1/50 (2%)	3/50 (6%)	2/50 (4%)
Adjusted rate	2.2%	4.0%	9.0%	14.5%
Terminal rate	0/13 (0%)	0/16 (0%)	0/14 (0%)	0/8 (0%)
First incidence (days)	504	650	509	656
Life table test	P=0.307	P=0.743	P=0.304	P=0.447
Logistic regression test	P=0.319	P=0.753N	P=0.264	P=0.500
Cochran-Armitage test	P=0.324			
Fisher exact test		P=0.753N	P=0.309	P=0.500
Lung: Alveolar/bronchiolar Adenoma				
Overall rate	1/50 (2%)	2/50 (4%)	0/50 (0%)	3/50 (6%)
Adjusted rate	7.7%	12.5%	0.0%	8.2%
Terminal rate	1/13 (8%)	2/16 (13%)	0/14 (0%)	0/8 (0%)
First incidence (days)	733 (T)	733 (T)	—	544
Life table test	P=0.178	P=0.574	P=0.485N	P=0.278
Logistic regression test	P=0.239	P=0.574	P=0.485N	P=0.305
Cochran-Armitage test	P=0.242			
Fisher exact test		P=0.500	P=0.500N	P=0.309
Lung: Alveolar/bronchiolar Adenoma or Carcinoma				
Overall rate	1/50 (2%)	2/50 (4%)	2/50 (4%)	3/50 (6%)
Adjusted rate	7.7%	12.5%	10.6%	8.2%
Terminal rate	1/13 (8%)	2/16 (13%)	1/14 (7%)	0/8 (0%)
First incidence (days)	733 (T)	733 (T)	650	544
Life table test	P=0.160	P=0.574	P=0.513	P=0.278
Logistic regression test	P=0.225	P=0.574	P=0.485	P=0.305
Cochran-Armitage test	P=0.232			
Fisher exact test		P=0.500	P=0.500	P=0.309
Pancreatic Islets: Adenoma				
Overall rate	8/50 (16%)	9/50 (18%)	4/50 (8%)	1/50 (2%)
Adjusted rate	26.9%	40.6%	20.0%	4.5%
Terminal rate	0/13 (0%)	5/16 (31%)	2/14 (14%)	0/8 (0%)
First incidence (days)	552	601	590	681
Life table test	P=0.014N	P=0.509	P=0.191N	P=0.029N
Logistic regression test	P=0.006N	P=0.472	P=0.177N	P=0.018N
Cochran-Armitage test	P=0.006N			
Fisher exact test		P=0.500	P=0.178N	P=0.015N
Pancreatic Islets: Carcinoma				
Overall rate	1/50 (2%)	1/50 (2%)	3/50 (6%)	5/50 (10%)
Adjusted rate	7.7%	5.9%	14.2%	25.9%
Terminal rate	1/13 (8%)	0/16 (0%)	1/14 (7%)	1/8 (13%)
First incidence (days)	733 (T)	714	621	634
Life table test	P=0.016	P=0.750N	P=0.318	P=0.068
Logistic regression test	P=0.026	P=0.747	P=0.297	P=0.089
Cochran-Armitage test	P=0.031			
Fisher exact test		P=0.753N	P=0.309	P=0.102

TABLE A3
Statistical Analysis of Primary Neoplasms in Male Rats in the 2-Year Inhalation Study of Nitromethane (continued)

	0 ppm	94 ppm	188 ppm	375 ppm
Pancreatic Islets: Adenoma or Carcinoma				
Overall rate	9/50 (18%)	10/50 (20%)	7/50 (14%)	6/50 (12%)
Adjusted rate	32.5%	44.1%	32.2%	29.3%
Terminal rate	1/13 (8%)	5/16 (31%)	3/14 (21%)	1/8 (13%)
First incidence (days)	552	601	590	634
Life table test	P=0.308N	P=0.513	P=0.393N	P=0.388N
Logistic regression test	P=0.186N	P=0.462	P=0.389N	P=0.294N
Cochran-Armitage test	P=0.181N			
Fisher exact test		P=0.500	P=0.393N	P=0.288N
Pituitary Gland (Pars Distalis): Adenoma				
Overall rate	38/50 (76%)	36/47 (77%)	32/50 (64%)	39/49 (80%)
Adjusted rate	100.0%	97.1%	84.6%	97.1%
Terminal rate	13/13 (100%)	15/16 (94%)	9/14 (64%)	7/8 (88%)
First incidence (days)	242	490	499	444
Life table test	P=0.160	P=0.380N	P=0.228N	P=0.162
Logistic regression test	P=0.464	P=0.511	P=0.132N	P=0.424
Cochran-Armitage test	P=0.446			
Fisher exact test		P=0.568	P=0.138N	P=0.426
Preputial Gland: Adenoma				
Overall rate	4/50 (8%)	3/50 (6%)	3/50 (6%)	3/50 (6%)
Adjusted rate	15.4%	11.6%	13.1%	24.1%
Terminal rate	0/13 (0%)	0/16 (0%)	1/14 (7%)	1/8 (13%)
First incidence (days)	528	574	560	650
Life table test	P=0.530N	P=0.544N	P=0.508N	P=0.631N
Logistic regression test	P=0.443N	P=0.503N	P=0.499N	P=0.512N
Cochran-Armitage test	P=0.442N			
Fisher exact test		P=0.500N	P=0.500N	P=0.500N
Preputial Gland: Adenoma or Carcinoma				
Overall rate	4/50 (8%)	4/50 (8%)	4/50 (8%)	4/50 (8%)
Adjusted rate	15.4%	15.4%	14.9%	27.2%
Terminal rate	0/13 (0%)	0/16 (0%)	1/14 (7%)	1/8 (13%)
First incidence (days)	528	574	492	650
Life table test	P=0.484	P=0.593	P=0.634	P=0.510
Logistic regression test	P=0.569N	P=0.639	P=0.637	P=0.633
Cochran-Armitage test	P=0.570			
Fisher exact test		P=0.643N	P=0.643N	P=0.643N
Skin: Squamous Cell Papilloma				
Overall rate	0/50 (0%)	0/50 (0%)	0/50 (0%)	3/50 (6%)
Adjusted rate	0.0%	0.0%	0.0%	13.3%
Terminal rate	0/13 (0%)	0/16 (0%)	0/14 (0%)	0/8 (0%)
First incidence (days)	—	—	—	660
Life table test	P=0.012	—	—	P=0.109
Logistic regression test	P=0.011	—	—	P=0.113
Cochran-Armitage test	P=0.012			
Fisher exact test		—	—	P=0.121

TABLE A3
Statistical Analysis of Primary Neoplasms in Male Rats in the 2-Year Inhalation Study of Nitromethane (continued)

	0 ppm	94 ppm	188 ppm	375 ppm
Skin: Keratoacanthoma				
Overall rate	6/50 (12%)	2/50 (4%)	2/50 (4%)	2/50 (4%)
Adjusted rate	41.0%	10.0%	10.5%	16.3%
Terminal rate	5/13 (38%)	1/16 (6%)	1/14 (7%)	1/8 (13%)
First incidence (days)	673	650	643	675
Life table test	P=0.191N	P=0.092N	P=0.113N	P=0.268N
Logistic regression test	P=0.143N	P=0.155N	P=0.146N	P=0.220N
Cochran-Armitage test	P=0.113N			
Fisher exact test		P=0.134N	P=0.134N	P=0.134N
Skin: Squamous Cell Papilloma or Keratoacanthoma				
Overall rate	6/50 (12%)	2/50 (4%)	2/50 (4%)	4/50 (8%)
Adjusted rate	41.0%	10.0%	10.5%	24.1%
Terminal rate	5/13 (38%)	1/16 (6%)	1/14 (7%)	1/8 (13%)
First incidence (days)	673	650	643	660
Life table test	P=0.550N	P=0.092N	P=0.113N	P=0.581N
Logistic regression test	P=0.450N	P=0.155N	P=0.146N	P=0.484N
Cochran-Armitage test	P=0.388N			
Fisher exact test		P=0.134N	P=0.134N	P=0.370N
Skin: Squamous Cell Papilloma, Keratoacanthoma, or Squamous Cell Carcinoma				
Overall rate	7/50 (14%)	4/50 (8%)	3/50 (6%)	5/50 (10%)
Adjusted rate	44.7%	22.0%	12.8%	35.0%
Terminal rate	5/13 (38%)	3/16 (19%)	1/14 (7%)	2/8 (25%)
First incidence (days)	673	650	608	660
Life table test	P=0.563N	P=0.185N	P=0.143N	P=0.614
Logistic regression test	P=0.427N	P=0.305N	P=0.167N	P=0.529N
Cochran-Armitage test	P=0.356N			
Fisher exact test		P=0.262N	P=0.159N	P=0.380N
Skin: Basal Cell Carcinoma or Squamous Cell Carcinoma				
Overall rate	1/50 (2%)	2/50 (4%)	1/50 (2%)	3/50 (6%)
Adjusted rate	6.3%	12.5%	2.6%	20.5%
Terminal rate	0/13 (0%)	2/16 (13%)	0/14 (0%)	1/8 (13%)
First incidence (days)	725	733 (T)	608	480
Life table test	P=0.138	P=0.548	P=0.758N	P=0.192
Logistic regression test	P=0.231	P=0.486	P=0.762N	P=0.300
Cochran-Armitage test	P=0.237			
Fisher exact test		P=0.500	P=0.753N	P=0.309
Skin: Squamous Cell Papilloma, Keratoacanthoma, Basal Cell Carcinoma, or Squamous Cell Carcinoma				
Overall rate	7/50 (14%)	4/50 (8%)	3/50 (6%)	7/50 (14%)
Adjusted rate	44.7%	22.0%	12.8%	40.9%
Terminal rate	5/13 (38%)	3/16 (19%)	1/14 (7%)	2/8 (25%)
First incidence (days)	673	650	608	480
Life table test	P=0.277	P=0.185N	P=0.143N	P=0.352
Logistic regression test	P=0.438	P=0.305N	P=0.167N	P=0.543
Cochran-Armitage test	P=0.485			
Fisher exact test		P=0.262N	P=0.159N	P=0.613N

TABLE A3
Statistical Analysis of Primary Neoplasms in Male Rats in the 2-Year Inhalation Study of Nitromethane (continued)

	0 ppm	94 ppm	188 ppm	375 ppm
Skin (Subcutaneous Tissue): Fibroma				
Overall rate	3/50 (6%)	0/50 (0%)	1/50 (2%)	0/50 (0%)
Adjusted rate	13.9%	0.0%	4.5%	0.0%
Terminal rate	1/13 (8%)	0/16 (0%)	0/14 (0%)	0/8 (0%)
First incidence (days)	623	—	678	—
Life table test	P=0.098N	P=0.126N	P=0.311N	P=0.158N
Logistic regression test	P=0.087N	P=0.128N	P=0.305N	P=0.125N
Cochran-Armitage test	P=0.086N			
Fisher exact test		P=0.121N	P=0.309N	P=0.121N
Skin (Subcutaneous Tissue): Fibrosarcoma				
Overall rate	3/50 (6%)	0/50 (0%)	0/50 (0%)	0/50 (0%)
Adjusted rate	18.2%	0.0%	0.0%	0.0%
Terminal rate	2/13 (15%)	0/16 (0%)	0/14 (0%)	0/8 (0%)
First incidence (days)	644	—	—	—
Life table test	P=0.058N	P=0.105N	P=0.118N	P=0.186N
Logistic regression test	P=0.051N	P=0.133N	P=0.125N	P=0.142N
Cochran-Armitage test	P=0.047N			
Fisher exact test		P=0.121N	P=0.121N	P=0.121N
Skin (Subcutaneous Tissue): Fibrosarcoma or Sarcoma				
Overall rate	3/50 (6%)	0/50 (0%)	2/50 (4%)	0/50 (0%)
Adjusted rate	18.2%	0.0%	10.9%	0.0%
Terminal rate	2/13 (15%)	0/16 (0%)	0/14 (0%)	0/8 (0%)
First incidence (days)	644	—	678	—
Life table test	P=0.168N	P=0.105N	P=0.494N	P=0.186N
Logistic regression test	P=0.141N	P=0.133N	P=0.517N	P=0.142N
Cochran-Armitage test	P=0.125N			
Fisher exact test		P=0.121N	P=0.500N	P=0.121N
Testes: Adenoma				
Overall rate	38/50 (76%)	34/50 (68%)	40/50 (80%)	31/50 (62%)
Adjusted rate	100.0%	91.1%	100.0%	100.0%
Terminal rate	13/13 (100%)	13/16 (81%)	14/14 (100%)	8/8 (100%)
First incidence (days)	490	427	395	480
Life table test	P=0.418	P=0.293N	P=0.458	P=0.455
Logistic regression test	P=0.080N	P=0.325N	P=0.454	P=0.073N
Cochran-Armitage test	P=0.117N			
Fisher exact test		P=0.252N	P=0.405	P=0.097N
Thyroid Gland (C-cell): Adenoma				
Overall rate	8/50 (16%)	5/50 (10%)	8/50 (16%)	8/50 (16%)
Adjusted rate	30.6%	24.7%	42.6%	50.9%
Terminal rate	1/13 (8%)	3/16 (19%)	5/14 (36%)	3/8 (38%)
First incidence (days)	504	574	560	617
Life table test	P=0.237	P=0.280N	P=0.598N	P=0.404
Logistic regression test	P=0.407	P=0.300N	P=0.608	P=0.586
Cochran-Armitage test	P=0.433			
Fisher exact test		P=0.277N	P=0.607N	P=0.607N

TABLE A3
Statistical Analysis of Primary Neoplasms in Male Rats in the 2-Year Inhalation Study of Nitromethane (continued)

	0 ppm	94 ppm	188 ppm	375 ppm
Thyroid Gland (C-cell): Carcinoma				
Overall rate	0/50 (0%)	2/50 (4%)	1/50 (2%)	3/50 (6%)
Adjusted rate	0.0%	10.0%	6.7%	14.2%
Terminal rate	0/13 (0%)	1/16 (6%)	0/14 (0%)	0/8 (0%)
First incidence (days)	—	650	728	607
Life table test	P=0.071	P=0.249	P=0.514	P=0.101
Logistic regression test	P=0.096	P=0.222	P=0.482	P=0.117
Cochran-Armitage test	P=0.104			
Fisher exact test		P=0.247	P=0.500	P=0.121
Thyroid Gland (C-cell): Adenoma or Carcinoma				
Overall rate	8/50 (16%)	7/50 (14%)	9/50 (18%)	11/50 (22%)
Adjusted rate	30.6%	33.3%	46.4%	57.8%
Terminal rate	1/13 (8%)	4/16 (25%)	5/14 (36%)	3/8 (38%)
First incidence (days)	504	574	560	607
Life table test	P=0.079	P=0.488N	P=0.508	P=0.164
Logistic regression test	P=0.174	P=0.536N	P=0.498	P=0.282
Cochran-Armitage test	P=0.198			
Fisher exact test		P=0.500N	P=0.500	P=0.306
All Organs: Mononuclear Cell Leukemia				
Overall rate	35/50 (70%)	27/50 (54%)	33/50 (66%)	25/50 (50%)
Adjusted rate	88.2%	92.1%	80.3%	90.0%
Terminal rate	9/13 (69%)	14/16 (88%)	7/14 (50%)	6/8 (75%)
First incidence (days)	411	427	499	405
Life table test	P=0.388N	P=0.119N	P=0.441N	P=0.357N
Logistic regression test	P=0.053N	P=0.091N	P=0.410N	P=0.033N
Cochran-Armitage test	P=0.059N			
Fisher exact test		P=0.074N	P=0.415N	P=0.033N
All Organs: Malignant Mesothelioma				
Overall rate	1/50 (2%)	3/50 (6%)	0/50 (0%)	1/50 (2%)
Adjusted rate	2.1%	8.1%	0.0%	9.1%
Terminal rate	0/13 (0%)	0/16 (0%)	0/14 (0%)	0/8 (0%)
First incidence (days)	490	439	—	709
Life table test	P=0.435N	P=0.297	P=0.500N	P=0.696
Logistic regression test	P=0.441N	P=0.324	P=0.588N	P=0.759
Cochran-Armitage test	P=0.409N			
Fisher exact test		P=0.309	P=0.500N	P=0.753N
All Organs: Benign Neoplasms				
Overall rate	50/50 (100%)	45/50 (90%)	50/50 (100%)	47/50 (94%)
Adjusted rate	100.0%	100.0%	100.0%	100.0%
Terminal rate	13/13 (100%)	16/16 (100%)	14/14 (100%)	8/8 (100%)
First incidence (days)	242	427	395	444
Life table test	P=0.229	P=0.293N	P=0.530N	P=0.278
Logistic regression test	P=0.139N	P=0.023N	— ^f	P=0.045N
Cochran-Armitage test	P=0.313N			
Fisher exact test		P=0.028N	P=1.000N	P=0.121N

TABLE A3
Statistical Analysis of Primary Neoplasms in Male Rats in the 2-Year Inhalation Study of Nitromethane (continued)

	0 ppm	94 ppm	188 ppm	375 ppm
All Organs: Malignant Neoplasms				
Overall rate	40/50 (80%)	35/50 (70%)	39/50 (78%)	33/50 (66%)
Adjusted rate	92.4%	96.9%	89.6%	96.2%
Terminal rate	10/13 (77%)	15/16 (94%)	10/14 (71%)	7/8 (88%)
First incidence (days)	411	292	395	405
Life table test	P=0.475	P=0.258N	P=0.489N	P=0.529
Logistic regression test	P=0.107N	P=0.197N	P=0.499N	P=0.087N
Cochran-Armitage test	P=0.112N			
Fisher exact test		P=0.178N	P=0.500N	P=0.088N
All Organs: Benign or Malignant Neoplasms				
Overall rate	50/50 (100%)	49/50 (98%)	50/50 (100%)	49/50 (98%)
Adjusted rate	100.0%	100.0%	100.0%	100.0%
Terminal rate	13/13 (100%)	16/16 (100%)	14/14 (100%)	8/8 (100%)
First incidence (days)	242	292	395	405
Life table test	P=0.210	P=0.481N	P=0.530N	P=0.210
Logistic regression test	P=0.340N	P=0.510N	—	P=0.455N
Cochran-Armitage test	P=0.405N			
Fisher exact test		P=0.500N	P=1.000N	P=0.500N

(T)Terminal sacrifice

- ^a Number of neoplasm-bearing animals/number of animals examined. Denominator is number of animals examined microscopically for adrenal gland, kidney, liver, lung, pancreatic islets, pituitary gland, preputial gland, testes, and thyroid gland; for other tissues, denominator is number of animals necropsied.
- ^b Kaplan-Meier estimated neoplasm incidence at the end of the study after adjustment for intercurrent mortality
- ^c Observed incidence at terminal kill
- ^d Beneath the control incidence are the P values associated with the trend test. Beneath the exposed group incidence are the P values corresponding to pairwise comparisons between the controls and that exposed group. The life table test regards neoplasms in animals dying prior to terminal kill as being (directly or indirectly) the cause of death. The logistic regression test regards these lesions as nonfatal. The Cochran-Armitage and Fisher exact tests compare directly the overall incidence rates. For all tests, a negative trend or a lower incidence in an exposure group is indicated by N.
- ^e Not applicable; no neoplasms in animal group
- ^f Value of statistic cannot be computed.

TABLE A4
Summary of the Incidence of Nonneoplastic Lesions in Male Rats in the 2-Year Inhalation Study of Nitromethane^a

	0 ppm	94 ppm	188 ppm	375 ppm
Disposition Summary				
Animals initially in study	50	50	50	50
Early deaths				
Moribund	33	31	34	39
Natural deaths	4	3	2	3
Survivors				
Terminal sacrifice	13	16	14	8
Animals examined microscopically	50	50	50	50
Alimentary System				
Intestine large, cecum	(50)	(50)	(50)	(50)
Diverticulum				1 (2%)
Inflammation, acute		1 (2%)		1 (2%)
Necrosis	1 (2%)	1 (2%)		
Intestine small, duodenum	(50)	(50)	(50)	(49)
Necrosis	1 (2%)	1 (2%)		
Intestine small, jejunum	(50)	(50)	(50)	(50)
Diverticulum	1 (2%)			
Inflammation, acute		1 (2%)		
Liver	(50)	(50)	(50)	(50)
Angiectasis	1 (2%)	3 (6%)		3 (6%)
Basophilic focus	16 (32%)	19 (38%)	20 (40%)	23 (46%)
Clear cell focus	3 (6%)	5 (10%)	10 (20%)	6 (12%)
Cyst		2 (4%)	1 (2%)	
Degeneration, cystic	19 (38%)	15 (30%)	16 (32%)	22 (44%)
Degeneration, fatty	6 (12%)	6 (12%)	2 (4%)	8 (16%)
Eosinophilic focus	2 (4%)	4 (8%)	4 (8%)	3 (6%)
Hepatodiaphragmatic nodule	4 (8%)	4 (8%)	2 (4%)	2 (4%)
Inflammation, suppurative			1 (2%)	
Mixed cell focus	7 (14%)	6 (12%)	9 (18%)	7 (14%)
Necrosis	1 (2%)	2 (4%)	1 (2%)	2 (4%)
Regeneration	2 (4%)		1 (2%)	2 (4%)
Thrombosis			1 (2%)	
Bile duct, hyperplasia	44 (88%)	43 (86%)	47 (94%)	43 (86%)
Centrilobular, necrosis	7 (14%)	1 (2%)	1 (2%)	2 (4%)
Mesentery	(15)	(13)	(10)	(8)
Infiltration cellular		1 (8%)		
Artery, inflammation		2 (15%)		
Artery, mineralization		2 (15%)	1 (10%)	
Fat, hemorrhage		1 (8%)		1 (13%)
Fat, necrosis	12 (80%)	7 (54%)	9 (90%)	6 (75%)
Oral mucosa	(1)	(2)	(1)	
Gingival, hyperplasia		1 (50%)		
Gingival, inflammation, chronic active		1 (50%)		
Pharyngeal, hyperplasia, squamous	1 (100%)			
Pancreas	(50)	(50)	(50)	(50)
Atrophy	27 (54%)	28 (56%)	34 (68%)	32 (64%)
Basophilic focus		3 (6%)	7 (14%)	3 (6%)
Hyperplasia	2 (4%)	3 (6%)	5 (10%)	4 (8%)
Hyperplasia, focal		1 (2%)		
Hypertrophy			1 (2%)	
Artery, inflammation		3 (6%)		

^a Number of animals examined microscopically at the site and the number of animals with lesion

TABLE A4

Summary of the Incidence of Nonneoplastic Lesions in Male Rats in the 2-Year Inhalation Study of Nitromethane (continued)

	0 ppm	94 ppm	188 ppm	375 ppm
Alimentary System (continued)				
Salivary glands	(50)	(50)	(50)	(50)
Degeneration, fatty		1 (2%)		
Stomach, forestomach	(50)	(50)	(50)	(50)
Diverticulum			1 (2%)	
Hyperplasia, squamous		3 (6%)	1 (2%)	1 (2%)
Inflammation, acute	3 (6%)	2 (4%)		8 (16%)
Mineralization			1 (2%)	
Necrosis	6 (12%)	4 (8%)	3 (6%)	9 (18%)
Stomach, glandular	(50)	(50)	(50)	(50)
Inflammation, acute	1 (2%)		1 (2%)	2 (4%)
Inflammation, chronic				1 (2%)
Mineralization		4 (8%)	2 (4%)	
Necrosis	3 (6%)	1 (2%)	1 (2%)	3 (6%)
Tooth	(1)	(2)	(3)	
Developmental malformation			1 (33%)	
Foreign body		1 (50%)		
Inflammation, chronic active	1 (100%)	2 (100%)	2 (67%)	
Cardiovascular System				
Blood vessel			(1)	
Aorta, mineralization			1 (100%)	
Heart	(50)	(50)	(50)	(50)
Cardiomyopathy	45 (90%)	49 (98%)	47 (94%)	47 (94%)
Artery, mineralization		1 (2%)	1 (2%)	
Atrium, thrombosis	5 (10%)		3 (6%)	2 (4%)
Endocrine System				
Adrenal cortex	(50)	(50)	(50)	(50)
Accessory adrenal cortical nodule				1 (2%)
Atrophy		3 (6%)	1 (2%)	2 (4%)
Hyperplasia	24 (48%)	19 (38%)	22 (44%)	22 (44%)
Hypertrophy	6 (12%)	10 (20%)	11 (22%)	8 (16%)
Necrosis	1 (2%)		2 (4%)	1 (2%)
Thrombosis			1 (2%)	
Vacuolization cytoplasmic	1 (2%)	1 (2%)	4 (8%)	3 (6%)
Adrenal medulla	(50)	(50)	(50)	(50)
Hyperplasia	20 (40%)	23 (46%)	27 (54%)	22 (44%)
Necrosis	1 (2%)			1 (2%)
Islets, pancreatic	(50)	(50)	(50)	(50)
Hyperplasia	1 (2%)	2 (4%)		1 (2%)
Parathyroid gland	(47)	(49)	(49)	(48)
Hyperplasia	8 (17%)	4 (8%)	5 (10%)	7 (15%)
Pituitary gland	(50)	(47)	(50)	(49)
Pars distalis, hyperplasia	7 (14%)	7 (15%)	9 (18%)	8 (16%)
Thyroid gland	(50)	(50)	(50)	(50)
C-cell, hyperplasia	34 (68%)	37 (74%)	34 (68%)	41 (82%)
Follicular cell, hyperplasia	1 (2%)		2 (4%)	

TABLE A4
Summary of the Incidence of Nonneoplastic Lesions in Male Rats in the 2-Year Inhalation Study of Nitromethane (continued)

	0 ppm	94 ppm	188 ppm	375 ppm
General Body System				
None				
Genital System				
Epididymis	(50)	(50)	(50)	(50)
Granuloma sperm				2 (4%)
Preputial gland	(50)	(50)	(50)	(50)
Cyst		1 (2%)		1 (2%)
Inflammation, chronic active	5 (10%)	3 (6%)	3 (6%)	9 (18%)
Prostate	(50)	(50)	(50)	(50)
Inflammation, chronic active	7 (14%)	9 (18%)	2 (4%)	8 (16%)
Inflammation, suppurative	4 (8%)	2 (4%)	3 (6%)	6 (12%)
Seminal vesicle	(50)	(50)	(50)	(50)
Inflammation, chronic active				1 (2%)
Testes	(50)	(50)	(50)	(50)
Atrophy	4 (8%)	7 (14%)	5 (10%)	6 (12%)
Artery, inflammation		4 (8%)		3 (6%)
Interstitial cell, hyperplasia	17 (34%)	17 (34%)	12 (24%)	16 (32%)
Hematopoietic System				
Bone marrow	(50)	(50)	(50)	(50)
Congestion		1 (2%)		
Myelofibrosis	2 (4%)		1 (2%)	1 (2%)
Thrombosis	1 (2%)	1 (2%)		
Lymph node	(17)	(13)	(17)	(13)
Pancreatic, inflammation, granulomatous	1 (6%)			
Renal, hemorrhage		1 (8%)	2 (12%)	2 (15%)
Renal, infiltration cellular, plasma cell	1 (6%)			1 (8%)
Renal, inflammation, granulomatous	1 (6%)	1 (8%)		
Renal, pigmentation	2 (12%)	1 (8%)	2 (12%)	1 (8%)
Lymph node, mandibular	(48)	(48)	(48)	(49)
Hemorrhage			1 (2%)	
Infiltration cellular, plasma cell	1 (2%)	3 (6%)	5 (10%)	
Inflammation, granulomatous	1 (2%)			
Lymph node, mesenteric	(50)	(50)	(48)	(50)
Hemorrhage		1 (2%)	1 (2%)	
Inflammation, acute		1 (2%)		
Inflammation, granulomatous		1 (2%)	1 (2%)	
Lymph node, mediastinal	(50)	(45)	(50)	(47)
Hemorrhage	2 (4%)	1 (2%)	1 (2%)	1 (2%)
Inflammation, granulomatous				1 (2%)
Spleen	(50)	(50)	(50)	(50)
Fibrosis	14 (28%)	20 (40%)	26 (52%)	19 (38%)
Hematopoietic cell proliferation	1 (2%)	1 (2%)		1 (2%)
Hemorrhage		1 (2%)		
Necrosis	1 (2%)			1 (2%)
Thymus	(45)	(45)	(48)	(46)
Artery, inflammation		1 (2%)		

TABLE A4

Summary of the Incidence of Nonneoplastic Lesions in Male Rats in the 2-Year Inhalation Study of Nitromethane (continued)

	0 ppm	94 ppm	188 ppm	375 ppm
Integumentary System				
Mammary gland	(28)	(27)	(31)	(28)
Galactocele	2 (7%)		2 (6%)	3 (11%)
Hyperplasia	1 (4%)			
Hyperplasia, atypical	1 (4%)			1 (4%)
Duct, inflammation, chronic	1 (4%)			
Skin	(50)	(49)	(50)	(50)
Cyst	2 (4%)	1 (2%)		
Hyperkeratosis	3 (6%)	3 (6%)		1 (2%)
Inflammation, chronic active	1 (2%)	3 (6%)	1 (2%)	1 (2%)
Inflammation, granulomatous	2 (4%)	2 (4%)	2 (4%)	1 (2%)
Prepuce, inflammation, acute	2 (4%)		1 (2%)	
Subcutaneous tissue, cyst epithelial inclusion	1 (2%)			
Musculoskeletal System				
Bone	(50)	(50)	(50)	(50)
Fibrous osteodystrophy		3 (6%)	4 (8%)	2 (4%)
Hyperostosis	1 (2%)	2 (4%)		1 (2%)
Nervous System				
Brain	(50)	(50)	(50)	(50)
Degeneration			1 (2%)	
Hemorrhage	1 (2%)		1 (2%)	1 (2%)
Hydrocephalus	1 (2%)			2 (4%)
Inflammation, chronic			1 (2%)	
Mineralization			1 (2%)	
Artery, inflammation		1 (2%)		
Peripheral nerve				(1)
Radicular neuropathy				1 (100%)
Respiratory System				
Larynx	(50)	(50)	(50)	(50)
Metaplasia, squamous	1 (2%)			1 (2%)
Lung	(50)	(50)	(50)	(50)
Congestion	1 (2%)	1 (2%)		1 (2%)
Congestion, chronic	1 (2%)			
Hemorrhage	1 (2%)			
Inflammation, chronic active	2 (4%)	2 (4%)	1 (2%)	
Metaplasia, osseous			1 (2%)	1 (2%)
Mineralization			1 (2%)	
Alveolar epithelium, hyperplasia	4 (8%)	8 (16%)	10 (20%)	9 (18%)
Artery, mediastinum, inflammation		2 (4%)		

TABLE A4
Summary of the Incidence of Nonneoplastic Lesions in Male Rats in the 2-Year Inhalation Study of Nitromethane (continued)

	0 ppm	94 ppm	188 ppm	375 ppm
Respiratory System (continued)				
Nose	(50)	(50)	(50)	(50)
Foreign body		1 (2%)	3 (6%)	1 (2%)
Inflammation, chronic active	4 (8%)	1 (2%)	3 (6%)	2 (4%)
Inflammation, suppurative	10 (20%)	3 (6%)	3 (6%)	5 (10%)
Thrombosis	6 (12%)	3 (6%)	5 (10%)	2 (4%)
Nasolacrimal duct, inflammation, suppurative		1 (2%)	3 (6%)	
Olfactory epithelium, foreign body		1 (2%)		
Olfactory epithelium, inflammation, suppurative		1 (2%)		
Trachea	(50)	(50)	(50)	(50)
Mineralization			1 (2%)	
Epithelium, hyperplasia		1 (2%)		
Special Senses System				
Eye	(2)	(1)	(1)	(1)
Cataract				1 (100%)
Degeneration	2 (100%)	1 (100%)	1 (100%)	
Retina, atrophy				1 (100%)
Urinary System				
Kidney	(50)	(50)	(50)	(50)
Infarct	2 (4%)		1 (2%)	
Mineralization		1 (2%)	2 (4%)	
Nephropathy	50 (100%)	50 (100%)	50 (100%)	50 (100%)
Artery, inflammation		1 (2%)		
Pelvis, dilatation			1 (2%)	
Renal tubule, hyperplasia		3 (6%)	2 (4%)	1 (2%)
Urinary bladder	(50)	(50)	(50)	(50)
Hemorrhage		1 (2%)		
Inflammation, suppurative		1 (2%)		
Transitional epithelium, hyperplasia			1 (2%)	

APPENDIX B
SUMMARY OF LESIONS IN FEMALE RATS
IN THE 2-YEAR INHALATION STUDY
OF NITROMETHANE

TABLE B1	Summary of the Incidence of Neoplasms in Female Rats in the 2-Year Inhalation Study of Nitromethane	118
TABLE B2	Individual Animal Tumor Pathology of Female Rats in the 2-Year Inhalation Study of Nitromethane	122
TABLE B3	Statistical Analysis of Primary Neoplasms in Female Rats in the 2-Year Inhalation Study of Nitromethane	140
TABLE B4	Historical Incidence of Mammary Gland Neoplasms in Chamber Control Female F344/N Rats	145
TABLE B5	Summary of the Incidence of Nonneoplastic Lesions in Female Rats in the 2-Year Inhalation Study of Nitromethane	146

TABLE B1
Summary of the Incidence of Neoplasms in Female Rats in the 2-Year Inhalation Study of Nitromethane^a

	0 ppm	94 ppm	188 ppm	375 ppm
Disposition Summary				
Animals initially in study	50	50	50	50
Early deaths				
Moribund	17	26	18	25
Natural deaths	5	5	2	2
Survivors				
Terminal sacrifice	28	19	30	23
Animals examined microscopically	50	50	50	50
Alimentary System				
Intestine large, colon	(50)	(50)	(50)	(50)
Intestine large, cecum	(50)	(50)	(50)	(50)
Intestine small, duodenum	(50)	(50)	(50)	(50)
Intestine small, jejunum	(50)	(50)	(50)	(50)
Intestine small, ileum	(50)	(50)	(50)	(50)
Liver	(50)	(50)	(50)	(50)
Carcinoma, metastatic, islets, pancreatic		1 (2%)		
Hepatocellular adenoma	1 (2%)	1 (2%)		
Histiocytic sarcoma				1 (2%)
Mesentery	(10)	(11)	(12)	(14)
Carcinoma, metastatic, islets, pancreatic		1 (9%)		
Carcinoma, metastatic, urinary bladder				1 (7%)
Histiocytic sarcoma				1 (7%)
Oral mucosa	(1)		(1)	(1)
Pharyngeal, squamous cell papilloma	1 (100%)		1 (100%)	1 (100%)
Pancreas	(50)	(50)	(50)	(50)
Carcinoma, metastatic, urinary bladder				1 (2%)
Salivary glands	(50)	(50)	(50)	(50)
Stomach, forestomach	(50)	(50)	(50)	(50)
Stomach, glandular	(50)	(50)	(50)	(50)
Tongue			(1)	
Squamous cell carcinoma			1 (100%)	
Cardiovascular System				
Heart	(50)	(50)	(50)	(50)
Histiocytic sarcoma				1 (2%)
Endocrine System				
Adrenal cortex	(50)	(50)	(50)	(50)
Adrenal medulla	(49)	(50)	(49)	(50)
Pheochromocytoma malignant			1 (2%)	
Pheochromocytoma complex	1 (2%)			
Pheochromocytoma benign		1 (2%)	2 (4%)	2 (4%)
Bilateral, pheochromocytoma benign	1 (2%)			2 (4%)
Islets, pancreatic	(50)	(50)	(50)	(50)
Adenoma	1 (2%)	1 (2%)	3 (6%)	1 (2%)
Carcinoma		1 (2%)		
Parathyroid gland	(50)	(49)	(50)	(48)
Adenoma			1 (2%)	

TABLE B1
Summary of the Incidence of Neoplasms in Female Rats in the 2-Year Inhalation Study of Nitromethane (continued)

	0 ppm	94 ppm	188 ppm	375 ppm
Endocrine System (continued)				
Pituitary gland	(50)	(50)	(50)	(50)
Pars distalis, adenoma	33 (66%)	36 (72%)	39 (78%)	40 (80%)
Pars distalis, carcinoma			1 (2%)	
Thyroid gland	(50)	(50)	(50)	(49)
Bilateral, C-cell, adenoma			1 (2%)	
C-cell, adenoma	8 (16%)	9 (18%)	7 (14%)	10 (20%)
C-cell, carcinoma	2 (4%)			3 (6%)
Follicular cell, adenoma		1 (2%)		
General Body System				
None				
Genital System				
Clitoral gland	(47)	(46)	(47)	(48)
Adenoma	6 (13%)	4 (9%)	5 (11%)	2 (4%)
Carcinoma		1 (2%)	3 (6%)	
Histiocytic sarcoma				1 (2%)
Bilateral, adenoma	1 (2%)		1 (2%)	
Ovary	(50)	(50)	(50)	(50)
Granulosa cell tumor benign		1 (2%)	1 (2%)	
Histiocytic sarcoma				1 (2%)
Uterus	(50)	(50)	(50)	(50)
Leiomyoma	1 (2%)			
Polyp stromal	5 (10%)	11 (22%)	6 (12%)	5 (10%)
Polyp stromal, multiple	1 (2%)			1 (2%)
Sarcoma stromal		1 (2%)	1 (2%)	
Hematopoietic System				
Bone marrow	(50)	(50)	(50)	(50)
Lymph node	(7)	(6)	(9)	(3)
Lymph node, bronchial	(48)	(49)	(47)	(48)
Carcinoma, metastatic, thyroid gland				1 (2%)
Lymph node, mandibular	(49)	(48)	(48)	(47)
Lymph node, mesenteric	(50)	(50)	(49)	(50)
Lymph node, mediastinal	(48)	(49)	(50)	(46)
Spleen	(50)	(49)	(50)	(50)
Thymus	(48)	(47)	(45)	(48)
Integumentary System				
Mammary gland	(50)	(50)	(50)	(50)
Adenoma	2 (4%)			2 (4%)
Carcinoma	2 (4%)	4 (8%)	1 (2%)	10 (20%)
Carcinoma, multiple		3 (6%)		1 (2%)
Fibroadenoma	10 (20%)	15 (30%)	19 (38%)	22 (44%)
Fibroadenoma, multiple	9 (18%)	6 (12%)	14 (28%)	14 (28%)
Histiocytic sarcoma				1 (2%)
Sarcoma, metastatic, skin		1 (2%)		

TABLE B1
Summary of the Incidence of Neoplasms in Female Rats in the 2-Year Inhalation Study of Nitromethane (continued)

	0 ppm	94 ppm	188 ppm	375 ppm
Integumentary System (continued)				
Skin	(50)	(50)	(48)	(49)
Squamous cell carcinoma			1 (2%)	
Squamous cell papilloma	1 (2%)	1 (2%)		1 (2%)
Subcutaneous tissue, fibroma	1 (2%)	1 (2%)		
Subcutaneous tissue, fibrosarcoma		1 (2%)		1 (2%)
Subcutaneous tissue, histiocytic sarcoma				1 (2%)
Subcutaneous tissue, sarcoma		1 (2%)		2 (4%)
Subcutaneous tissue, schwannoma malignant			1 (2%)	
Subcutaneous tissue, pinna, amelanotic melanoma, malignant				1 (2%)
Musculoskeletal System				
Bone	(50)	(50)	(50)	(50)
Osteosarcoma	1 (2%)			
Skeletal muscle	(1)	(2)		(1)
Carcinoma, metastatic, urinary bladder				1 (100%)
Nervous System				
Brain	(50)	(50)	(50)	(50)
Astrocytoma benign	1 (2%)			
Carcinoma, metastatic, pituitary gland			1 (2%)	
Respiratory System				
Larynx	(50)	(50)	(50)	(49)
Lung	(50)	(50)	(50)	(50)
Alveolar/bronchiolar adenoma		1 (2%)	1 (2%)	1 (2%)
Alveolar/bronchiolar carcinoma	1 (2%)			
Carcinoma, metastatic, islets, pancreatic		1 (2%)		
Carcinoma, metastatic, mammary gland		1 (2%)	1 (2%)	
Histiocytic sarcoma				1 (2%)
Osteosarcoma, metastatic, bone	1 (2%)			
Nose	(50)	(50)	(50)	(50)
Trachea	(50)	(50)	(50)	(50)
Carcinoma, metastatic, lung	1 (2%)			
Special Senses System				
Harderian gland	(3)			
Zymbal's gland	(1)	(1)		(1)
Carcinoma	1 (100%)	1 (100%)		1 (100%)

TABLE B1
Summary of the Incidence of Neoplasms in Female Rats in the 2-Year Inhalation Study of Nitromethane (continued)

	0 ppm	94 ppm	188 ppm	375 ppm
Urinary System				
Kidney	(50)	(50)	(50)	(50)
Carcinoma, metastatic, urinary bladder				1 (2%)
Lipoma		1 (2%)		
Mesenchymal tumor malignant				1 (2%)
Renal tubule, carcinoma	1 (2%)			
Urinary bladder	(50)	(50)	(49)	(50)
Histiocytic sarcoma				1 (2%)
Transitional epithelium, carcinoma				1 (2%)
Transitional epithelium, papilloma			2 (4%)	
Systemic Lesions				
Multiple organs ^b	(50)	(50)	(50)	(50)
Histiocytic sarcoma				1 (2%)
Leukemia mononuclear	22 (44%)	13 (26%)	14 (28%)	9 (18%)
Neoplasm Summary				
Total animals with primary neoplasms ^c	49	50	50	50
Total primary neoplasms	114	116	127	135
Total animals with benign neoplasms	44	47	48	49
Total benign neoplasms	83	90	103	104
Total animals with malignant neoplasms	28	21	20	27
Total malignant neoplasms	31	26	24	31
Total animals with metastatic neoplasms	2	3	2	2
Total metastatic neoplasms	2	5	2	5

^a Number of animals examined microscopically at the site and the number of animals with neoplasm

^b Number of animals with any tissue examined microscopically

^c Primary neoplasms: all neoplasms except metastatic neoplasms

TABLE B2
Individual Animal Tumor Pathology of Female Rats in the 2-Year Inhalation Study of Nitromethane: 0 ppm

Number of Days on Study	4	5	5	5	5	5	5	6	6	6	6	6	6	6	6	6	6	7	7	7	7	7	7		
	5	1	1	3	4	6	7	8	0	0	3	3	3	5	5	8	9	9	1	1	2	2	3	3	
	4	9	9	9	4	5	3	5	0	4	0	1	1	0	8	1	1	1	3	4	6	7	3	3	
Carcass ID Number	1	1	1	1	1	1	1	1	1	1	1	1	1	1	1	1	1	1	1	1	1	1	1	1	
	2	1	2	2	0	4	2	4	3	1	3	3	3	2	4	4	0	2	1	1	1	0	2	2	
	8	2	1	0	5	6	5	8	4	3	9	6	8	6	3	2	6	7	4	7	9	3	2	3	
Alimentary System																									
Esophagus	+	+	+	+	+	+	+	+	+	+	+	+	+	+	+	+	+	+	+	+	+	+	+	+	
Intestine large, colon	+	+	+	+	+	+	+	+	+	+	+	+	+	+	+	+	+	+	+	+	+	+	+	+	
Intestine large, rectum	+	+	+	+	+	+	+	+	+	+	+	+	+	+	+	+	+	+	+	+	+	+	+	+	
Intestine large, cecum	+	+	+	+	+	+	+	+	+	+	+	+	+	+	+	+	+	+	+	+	+	+	+	+	
Intestine small, duodenum	+	+	+	+	+	+	+	+	+	+	+	+	+	+	+	+	+	+	+	+	+	+	+	+	
Intestine small, jejunum	+	+	+	+	+	+	+	+	+	+	+	+	+	+	+	+	+	+	+	+	+	+	+	+	
Intestine small, ileum	+	+	+	+	+	+	+	+	+	+	+	+	+	+	+	+	+	+	+	+	+	+	+	+	
Liver	+	+	+	+	+	+	+	+	+	+	+	+	+	+	+	+	+	+	+	+	+	+	+	+	
Hepatocellular adenoma																	X								
Mesentery	+							+							+	+						+			
Oral mucosa																						+			
Pharyngeal, squamous cell papilloma																						X			
Pancreas	+	+	+	+	+	+	+	+	+	+	+	+	+	+	+	+	+	+	+	+	+	+	+	+	
Salivary glands	+	+	+	+	+	+	+	+	+	+	+	+	+	+	+	+	+	+	+	+	+	+	+	+	
Stomach, forestomach	+	+	+	+	+	+	+	+	+	+	+	+	+	+	+	+	+	+	+	+	+	+	+	+	
Stomach, glandular	+	+	+	+	+	+	+	+	+	+	+	+	+	+	+	+	+	+	+	+	+	+	+	+	
Cardiovascular System																									
Heart	+	+	+	+	+	+	+	+	+	+	+	+	+	+	+	+	+	+	+	+	+	+	+	+	
Endocrine System																									
Adrenal cortex	+	+	+	+	+	+	+	+	+	+	+	+	+	+	+	+	+	+	+	+	+	+	+	+	
Adrenal medulla	+	+	+	+	+	+	+	+	M	+	+	+	+	+	+	+	+	+	+	+	+	+	+	+	
Pheochromocytoma complex																									
Bilateral, pheochromocytoma benign																									
Islets, pancreatic	+	+	+	+	+	+	+	+	+	+	+	+	+	+	+	+	+	+	+	+	+	+	+	+	
Adenoma																									
Parathyroid gland	+	+	+	+	+	+	+	+	+	+	+	+	+	+	+	+	+	+	+	+	+	+	+	+	
Pituitary gland	+	+	+	+	+	+	+	+	+	+	+	+	+	+	+	+	+	+	+	+	+	+	+	+	
Pars distalis, adenoma	X	X		X	X	X	X	X		X	X	X		X	X	X	X	X		X			X		
Thyroid gland	+	+	+	+	+	+	+	+	+	+	+	+	+	+	+	+	+	+	+	+	+	+	+	+	
C-cell, adenoma									X					X									X		
C-cell, carcinoma																									
General Body System																									
None																									
Genital System																									
Clitoral gland	M	+	+	+	+	+	+	+	+	+	+	+	+	+	+	+	+	+	+	+	+	+	+	+	
Adenoma																									
Bilateral, adenoma																									
Ovary	+	+	+	+	+	+	+	+	+	+	+	+	+	+	+	+	+	+	+	+	+	+	+	+	
Uterus	+	+	+	+	+	+	+	+	+	+	+	+	+	+	+	+	+	+	+	+	+	+	+	+	
Leiomyoma																									
Polyp stromal																						X		X	
Polyp stromal, multiple																							X		
Vagina																									

+: Tissue examined microscopically
A: Autolysis precludes examination

M: Missing tissue
I: Insufficient tissue

X: Lesion present
Blank: Not examined

TABLE B2
Individual Animal Tumor Pathology of Female Rats in the 2-Year Inhalation Study of Nitromethane: 0 ppm (continued)

Number of Days on Study	7	7	7	7	7	7	7	7	7	7	7	7	7	7	7	7	7	7	7	7	7	7	7	7	Total Tissues/ Tumors
Carcass ID Number	1	1	1	1	1	1	1	1	1	1	1	1	1	1	1	1	1	1	1	1	1	1	1	1	
	3	3	3	3	3	3	3	3	3	3	3	3	3	3	3	3	3	3	3	3	3	3	3	3	
	3	3	3	3	4	4	4	4	4	4	4	4	4	4	4	4	5	5	5	5	5	5	5	5	
Hematopoietic System																									
Bone marrow	+	+	+	+	+	+	+	+	+	+	+	+	+	+	+	+	+	+	+	+	+	+	+	+	50
Lymph node																								+	7
Lymph node, bronchial	+	+	+	+	+	+	+	+	+	+	+	+	+	+	+	+	+	+	+	+	+	+	+	+	48
Lymph node, mandibular	+	+	+	+	+	+	+	+	+	+	+	+	+	+	+	+	+	+	+	+	+	+	+	+	49
Lymph node, mesenteric	+	+	+	+	+	+	+	+	+	+	+	+	+	+	+	+	+	+	+	+	+	+	+	+	50
Lymph node, mediastinal	+	+	+	+	M	+	+	+	+	+	+	+	+	+	+	+	+	+	+	+	+	+	+	+	48
Spleen	+	+	+	+	+	+	+	+	+	+	+	+	+	+	+	+	+	+	+	+	+	+	+	+	50
Thymus	+	+	+	+	M	+	+	M	+	+	+	+	+	+	+	+	+	+	+	+	+	+	+	+	48
Integumentary System																									
Mammary gland	+	+	+	+	+	+	+	+	+	+	+	+	+	+	+	+	+	+	+	+	+	+	+	+	50
Adenoma							X					X													2
Carcinoma																						X			2
Fibroadenoma	X			X					X	X	X				X		X				X				10
Fibroadenoma, multiple			X						X				X	X					X			X	X		9
Skin	+	+	+	+	+	+	+	+	+	+	+	+	+	+	+	+	+	+	+	+	+	+	+	+	50
Squamous cell papilloma																									1
Subcutaneous tissue, fibroma																									1
Musculoskeletal System																									
Bone	+	+	+	+	+	+	+	+	+	+	+	+	+	+	+	+	+	+	+	+	+	+	+	+	50
Osteosarcoma																									1
Skeletal muscle																									1
Nervous System																									
Brain	+	+	+	+	+	+	+	+	+	+	+	+	+	+	+	+	+	+	+	+	+	+	+	+	50
Astrocytoma benign																									1
Respiratory System																									
Larynx	+	+	+	+	+	+	+	+	+	+	+	+	+	+	+	+	+	+	+	+	+	+	+	+	50
Lung	+	+	+	+	+	+	+	+	+	+	+	+	+	+	+	+	+	+	+	+	+	+	+	+	50
Alveolar/bronchiolar carcinoma																									1
Osteosarcoma, metastatic, bone																									1
Nose	+	+	+	+	+	+	+	+	+	+	+	+	+	+	+	+	+	+	+	+	+	+	+	+	50
Trachea	+	+	+	+	+	+	+	+	+	+	+	+	+	+	+	+	+	+	+	+	+	+	+	+	50
Carcinoma, metastatic, lung																									1
Special Senses System																									
Eye																								+	2
Harderian gland																									3
Zymbal's gland																								+	1
Carcinoma																								X	1
Urinary System																									
Kidney	+	+	+	+	+	+	+	+	+	+	+	+	+	+	+	+	+	+	+	+	+	+	+	+	50
Renal tubule, carcinoma																									1
Urinary bladder	+	+	+	+	+	+	+	+	+	+	+	+	+	+	+	+	+	+	+	+	+	+	+	+	50
Systemic Lesions																									
Multiple organs	+	+	+	+	+	+	+	+	+	+	+	+	+	+	+	+	+	+	+	+	+	+	+	+	50
Leukemia mononuclear					X							X	X			X	X			X				X	22

TABLE B2

Individual Animal Tumor Pathology of Female Rats in the 2-Year Inhalation Study of Nitromethane: 94 ppm (continued)

Number of Days on Study	4	4	4	4	4	5	5	5	5	5	5	5	5	5	5	6	6	6	6	6	6	6	6	6	6	6	6	6	6	6	6	6	6	6	6	6					
	2	3	7	8	9	1	2	5	6	7	7	8	8	8	0	0	2	2	3	6	6	6	6	7	8																
	8	5	3	8	5	2	0	1	1	6	9	0	6	8	0	6	1	3	6	2	4	5	7	2	0																
Carcass ID Number	3	3	3	3	3	3	3	3	3	3	3	3	3	3	3	3	3	3	3	3	3	3	3	3	3	3	3	3	3	3	3	3	3	3	3	3	3	3			
	3	3	3	2	3	4	1	3	0	4	4	3	2	0	1	2	3	1	4	0	1	1	2	4	0																
	6	8	4	5	2	6	6	0	5	8	5	5	3	7	2	1	9	3	3	1	4	5	2	9	4																
Hematopoietic System																																									
Bone marrow	+	+	+	+	+	+	+	+	+	+	+	+	+	+	+	+	+	+	+	+	+	+	+	+	+	+	+	+	+	+	+	+	+	+	+	+	+	+	+		
Lymph node										+												+	+	+																+	
Lymph node, bronchial	+	+	+	+	+	+	+	+	+	+	+	+	+	+	+	+	+	+	+	+	+	+	+	+	+	+	+	+	+	+	+	+	+	+	+	+	+	+	+	+	
Lymph node, mandibular	+	+	+	+	+	+	+	+	+	+	+	+	+	+	+	+	+	+	+	+	+	+	+	+	+	+	+	+	+	+	+	+	+	+	+	+	+	+	+	+	
Lymph node, mesenteric	+	+	+	+	+	+	+	+	+	+	+	+	+	+	+	+	+	+	+	+	+	+	+	+	+	+	+	+	+	+	+	+	+	+	+	+	+	+	+	+	
Lymph node, mediastinal	+	+	+	+	+	+	+	+	+	+	+	+	+	+	+	+	+	+	+	+	+	+	+	+	+	+	+	+	+	+	+	+	+	+	+	+	+	+	+	+	
Spleen	+	+	+	+	+	+	+	+	+	+	+	+	A	+	+	+	+	+	+	+	+	+	+	+	+	+	+	+	+	+	+	+	+	+	+	+	+	+	+		
Thymus	+	+	+	M	+	+	+	+	+	+	+	+	+	+	+	+	+	+	+	+	+	+	M	+	+	+	+	+	+	+	+	+	+	+	+	+	+	+	M	+	
Integumentary System																																									
Mammary gland	+	+	+	+	+	+	+	+	+	+	+	+	+	+	+	+	+	+	+	+	+	+	+	+	+	+	+	+	+	+	+	+	+	+	+	+	+	+	+	+	
Carcinoma																																									
Carcinoma, multiple																	X																								X
Fibroadenoma																																									X
Fibroadenoma, multiple																																									X
Sarcoma, metastatic, skin																																									
Skin	+	+	+	+	+	+	+	+	+	+	+	+	+	+	+	+	+	+	+	+	+	+	+	+	+	+	+	+	+	+	+	+	+	+	+	+	+	+	+	+	+
Squamous cell papilloma																																									
Subcutaneous tissue, fibroma																																									
Subcutaneous tissue, fibrosarcoma																																									X
Subcutaneous tissue, sarcoma																																									
Musculoskeletal System																																									
Bone	+	+	+	+	+	+	+	+	+	+	+	+	+	+	+	+	+	+	+	+	+	+	+	+	+	+	+	+	+	+	+	+	+	+	+	+	+	+	+	+	
Skeletal muscle																																									+
Nervous System																																									
Brain	+	+	+	+	+	+	+	+	+	+	+	+	+	+	+	+	+	+	+	+	+	+	+	+	+	+	+	+	+	+	+	+	+	+	+	+	+	+	+	+	
Respiratory System																																									
Larynx	+	+	+	+	+	+	+	+	+	+	+	+	+	+	+	+	+	+	+	+	+	+	+	+	+	+	+	+	+	+	+	+	+	+	+	+	+	+	+	+	+
Lung	+	+	+	+	+	+	+	+	+	+	+	+	+	+	+	+	+	+	+	+	+	+	+	+	+	+	+	+	+	+	+	+	+	+	+	+	+	+	+	+	+
Alveolar/bronchiolar adenoma																																									X
Carcinoma, metastatic, islets, pancreatic																																									X
Carcinoma, metastatic, mammary gland																																									
Nose	+	+	+	+	+	+	+	+	+	+	+	+	+	+	+	+	+	+	+	+	+	+	+	+	+	+	+	+	+	+	+	+	+	+	+	+	+	+	+	+	+
Trachea	+	+	+	+	+	+	+	+	+	+	+	+	+	+	+	+	+	+	+	+	+	+	+	+	+	+	+	+	+	+	+	+	+	+	+	+	+	+	+	+	+
Special Senses System																																									
Eye																																									+
Zymbal's gland																																									
Carcinoma																																									
Urinary System																																									
Kidney	+	+	+	+	+	+	+	+	+	+	+	+	+	+	+	+	+	+	+	+	+	+	+	+	+	+	+	+	+	+	+	+	+	+	+	+	+	+	+	+	+
Lipoma																																									X
Urinary bladder	+	+	+	+	+	+	+	+	+	+	+	+	+	+	+	+	+	+	+	+	+	+	+	+	+	+	+	+	+	+	+	+	+	+	+	+	+	+	+	+	+
Systemic Lesions																																									
Multiple organs	+	+	+	+	+	+	+	+	+	+	+	+	+	+	+	+	+	+	+	+	+	+	+	+	+	+	+	+	+	+	+	+	+	+	+	+	+	+	+	+	+
Leukemia mononuclear	X								X	X	X	X																										X	X	X	X

TABLE B2
Individual Animal Tumor Pathology of Female Rats in the 2-Year Inhalation Study of Nitromethane: 94 ppm (continued)

Number of Days on Study	6	6	7	7	7	7	7	7	7	7	7	7	7	7	7	7	7	7	7	7	7	7	7			
	9	9	0	2	2	3	3	3	3	3	3	3	3	3	3	3	3	3	3	3	3	3	3			
	1	8	0	0	7	0	3	3	3	3	3	3	3	3	4	4	4	5	5	5	5	5	5			
Carcass ID Number	3	3	3	3	3	3	3	3	3	3	3	3	3	3	3	3	3	3	3	3	3	3	3	Total Tissues/ Tumors		
	4	1	4	1	4	5	0	1	1	2	2	2	3	4	2	3	3	0	0	0	0	1	2	2	4	
	4	0	1	8	2	0	9	1	9	0	7	8	7	7	9	1	3	2	3	6	8	7	4	6	0	
Hematopoietic System																										
Bone marrow	+	+	+	+	+	+	+	+	+	+	+	+	+	+	+	+	+	+	+	+	+	+	+	+	+	50
Lymph node																									+	6
Lymph node, bronchial	M	+	+	+	+	+	+	+	+	+	+	+	+	+	+	+	+	+	+	+	+	+	+	+	+	49
Lymph node, mandibular	M	+	+	+	M	+	+	+	+	+	+	+	+	+	+	+	+	+	+	+	+	+	+	+	+	48
Lymph node, mesenteric	+	+	+	+	+	+	+	+	+	+	+	+	+	+	+	+	+	+	+	+	+	+	+	+	+	50
Lymph node, mediastinal	+	+	+	+	M	+	+	+	+	+	+	+	+	+	+	+	+	+	+	+	+	+	+	+	+	49
Spleen	+	+	+	+	+	+	+	+	+	+	+	+	+	+	+	+	+	+	+	+	+	+	+	+	+	49
Thymus	+	+	+	+	+	+	+	+	+	+	+	+	+	+	+	+	+	+	+	+	+	+	+	+	+	47
Integumentary System																										
Mammary gland	+	+	+	+	+	+	+	+	+	+	+	+	+	+	+	+	+	+	+	+	+	+	+	+	+	50
Carcinoma																X								X		4
Carcinoma, multiple						X																		X	X	3
Fibroadenoma	X	X	X							X	X											X	X	X	X	15
Fibroadenoma, multiple						X									X		X	X						X		6
Sarcoma, metastatic, skin			X																							1
Skin	+	+	+	+	+	+	+	+	+	+	+	+	+	+	+	+	+	+	+	+	+	+	+	+	+	50
Squamous cell papilloma											X															1
Subcutaneous tissue, fibroma																							X			1
Subcutaneous tissue, fibrosarcoma																										1
Subcutaneous tissue, sarcoma					X																					1
Musculoskeletal System																										
Bone	+	+	+	+	+	+	+	+	+	+	+	+	+	+	+	+	+	+	+	+	+	+	+	+	+	50
Skeletal muscle																										2
Nervous System																										
Brain	+	+	+	+	+	+	+	+	+	+	+	+	+	+	+	+	+	+	+	+	+	+	+	+	+	50
Respiratory System																										
Larynx	+	+	+	+	+	+	+	+	+	+	+	+	+	+	+	+	+	+	+	+	+	+	+	+	+	50
Lung	+	+	+	+	+	+	+	+	+	+	+	+	+	+	+	+	+	+	+	+	+	+	+	+	+	50
Alveolar/bronchiolar adenoma																										1
Carcinoma, metastatic, islets, pancreatic																										1
Carcinoma, metastatic, mammary gland																								X		1
Nose	+	+	+	+	+	+	+	+	+	+	+	+	+	+	+	+	+	+	+	+	+	+	+	+	+	50
Trachea	+	+	+	+	+	+	+	+	+	+	+	+	+	+	+	+	+	+	+	+	+	+	+	+	+	50
Special Senses System																										
Eye																										1
Zymbal's gland																								+		1
Carcinoma																							X			1
Urinary System																										
Kidney	+	+	+	+	+	+	+	+	+	+	+	+	+	+	+	+	+	+	+	+	+	+	+	+	+	50
Lipoma																										1
Urinary bladder	+	+	+	+	+	+	+	+	+	+	+	+	+	+	+	+	+	+	+	+	+	+	+	+	+	50
Systemic Lesions																										
Multiple organs	+	+	+	+	+	+	+	+	+	+	+	+	+	+	+	+	+	+	+	+	+	+	+	+	+	50
Leukemia mononuclear						X										X			X				X			13

TABLE B2
Individual Animal Tumor Pathology of Female Rats in the 2-Year Inhalation Study of Nitromethane: 188 ppm
 (continued)

Number of Days on Study	4	4	4	4	5	5	5	5	6	6	6	6	6	6	6	6	6	6	7	7	7	7	7	7	7		
	3	4	6	9	0	1	1	4	1	3	4	5	5	6	7	8	9	9	0	1	3	3	3	3	3		
	2	0	8	1	8	2	3	5	9	8	6	0	7	5	0	6	1	8	5	2	3	3	3	3	3		
Carcass ID Number	5	5	5	5	5	5	5	5	5	5	5	5	5	5	5	5	5	5	5	5	5	5	5	5	5		
	4	4	2	3	2	0	4	0	0	4	3	4	0	0	4	2	0	1	3	1	0	1	1	2	3		
	9	3	0	6	9	6	2	4	9	8	5	7	8	7	1	5	1	2	2	1	2	4	7	3	1		
Hematopoietic System																											
Bone marrow	+	+	+	+	+	+	+	+	+	+	+	+	+	+	+	+	+	+	+	+	+	+	+	+	+	+	
Lymph node					+	+																					
Lymph node, bronchial	+	+	+	+	+	+	+	+	+	+	+	M	+	+	+	M	+	+	+	+	+	+	+	+	+	M	
Lymph node, mandibular	M	+	+	+	+	+	+	+	+	+	+	+	+	+	+	+	+	M	+	+	+	+	+	+	+	+	
Lymph node, mesenteric	M	+	+	+	+	+	+	+	+	+	+	+	+	+	+	+	+	+	+	+	+	+	+	+	+	+	
Lymph node, mediastinal	+	+	+	+	+	+	+	+	+	+	+	+	+	+	+	+	+	+	+	+	+	+	+	+	+	+	
Spleen	+	+	+	+	+	+	+	+	+	+	+	+	+	+	+	+	+	+	+	+	+	+	+	+	+	+	
Thymus	+	+	+	+	+	+	+	+	+	+	+	+	+	+	+	+	M	+	+	+	+	M	+	+	+	+	
Integumentary System																											
Mammary gland	+	+	+	+	+	+	+	+	+	+	+	+	+	+	+	+	+	+	+	+	+	+	+	+	+	+	
Carcinoma			X																								
Fibroadenoma				X	X						X	X						X				X	X				
Fibroadenoma, multiple								X	X	X									X	X				X			
Skin	+	M	+	M	+	+	+	+	+	+	+	+	+	+	+	+	+	+	+	+	+	+	+	+	+	+	
Squamous cell carcinoma																										X	
Subcutaneous tissue, schwannoma malignant																										X	
Musculoskeletal System																											
Bone	+	+	+	+	+	+	+	+	+	+	+	+	+	+	+	+	+	+	+	+	+	+	+	+	+	+	
Nervous System																											
Brain	+	+	+	+	+	+	+	+	+	+	+	+	+	+	+	+	+	+	+	+	+	+	+	+	+	+	
Carcinoma, metastatic, pituitary gland																											
Respiratory System																											
Larynx	+	+	+	+	+	+	+	+	+	+	+	+	+	+	+	+	+	+	+	+	+	+	+	+	+	+	
Lung	+	+	+	+	+	+	+	+	+	+	+	+	+	+	+	+	+	+	+	+	+	+	+	+	+	+	
Alveolar/bronchiolar adenoma																										X	
Carcinoma, metastatic, mammary gland					X																						
Nose	+	+	+	+	+	+	+	+	+	+	+	+	+	+	+	+	+	+	+	+	+	+	+	+	+	+	
Trachea	+	+	+	+	+	+	+	+	+	+	+	+	+	+	+	+	+	+	+	+	+	+	+	+	+	+	
Special Senses System																											
Eye						+																				+	
Urinary System																											
Kidney	+	+	+	+	+	+	+	+	+	+	+	+	+	+	+	+	+	+	+	+	+	+	+	+	+	+	
Urinary bladder	M	+	+	+	+	+	+	+	+	+	+	+	+	+	+	+	+	+	+	+	+	+	+	+	+	+	
Transitional epithelium, papilloma																											
Systemic Lesions																											
Multiple organs	+	+	+	+	+	+	+	+	+	+	+	+	+	+	+	+	+	+	+	+	+	+	+	+	+	+	
Leukemia mononuclear						X	X	X							X	X				X	X						

TABLE B2
Individual Animal Tumor Pathology of Female Rats in the 2-Year Inhalation Study of Nitromethane: 375 ppm
 (continued)

Number of Days on Study	3	4	4	4	5	5	5	5	6	6	6	6	6	6	6	6	6	6	6	6	6	6	6	7	7
	8	2	9	9	5	5	9	9	0	0	0	0	3	3	4	5	6	6	6	7	7	7	8	0	1
	7	5	2	6	0	2	4	7	0	4	4	7	4	6	2	1	0	5	5	0	2	6	4	9	2
Carcass ID Number	7	7	7	7	7	7	7	7	7	7	7	7	7	7	7	7	7	7	7	7	7	7	7	7	7
	3	0	4	2	3	1	4	0	3	1	4	0	1	0	0	0	4	2	3	3	0	1	3	2	1
	7	7	7	8	4	7	9	1	9	6	1	2	2	6	4	8	5	6	5	3	3	9	2	4	1
Urinary System																									
Kidney	+	+	+	+	+	+	+	+	+	+	+	+	+	+	+	+	+	+	+	+	+	+	+	+	+
Carcinoma, metastatic, urinary bladder																									X
Mesenchymal tumor malignant							X																		
Urinary bladder	+	+	+	+	+	+	+	+	+	+	+	+	+	+	+	+	+	+	+	+	+	+	+	+	+
Histiocytic sarcoma												X													
Transitional epithelium, carcinoma																									X
Systemic Lesions																									
Multiple organs	+	+	+	+	+	+	+	+	+	+	+	+	+	+	+	+	+	+	+	+	+	+	+	+	+
Histiocytic sarcoma												X													
Leukemia mononuclear							X	X					X			X	X	X						X	

TABLE B2
Individual Animal Tumor Pathology of Female Rats in the 2-Year Inhalation Study of Nitromethane: 375 ppm
 (continued)

Number of Days on Study	7 7	
	2 2 3	
	0 0 3 3 3 3 3 3 3 3 3 3 4 4 4 4 4 4 4 4 4 4 5 5 5 5	
Carcass ID Number	7 7	Total
	2 3 1 1 2 2 3 3 4 4 5 0 0 1 1 2 2 2 3 4 4 1 2 4 4	Tissues/
	5 6 3 4 3 9 0 8 3 4 0 5 9 5 8 0 1 2 1 6 8 0 7 0 2	Tumors
Urinary System		
Kidney	+ +	50
Carcinoma, metastatic, urinary bladder		1
Mesenchymal tumor malignant		1
Urinary bladder	+ +	50
Histiocytic sarcoma		1
Transitional epithelium, carcinoma		1
Systemic Lesions		
Multiple organs	+ +	50
Histiocytic sarcoma		1
Leukemia mononuclear	X X	9

TABLE B3
Statistical Analysis of Primary Neoplasms in Female Rats in the 2-Year Inhalation Study of Nitromethane

	0 ppm	94 ppm	188 ppm	375 ppm
Adrenal Medulla: Benign Pheochromocytoma				
Overall rate ^a	1/49 (2%)	1/50 (2%)	2/49 (4%)	4/50 (8%)
Adjusted rate ^b	3.6%	5.3%	6.9%	13.5%
Terminal rate ^c	1/28 (4%)	1/19 (5%)	2/29 (7%)	1/23 (4%)
First incidence (days)	733 (T)	733 (T)	733 (T)	651
Life table test ^d	P=0.065	P=0.673	P=0.512	P=0.147
Logistic regression test ^d	P=0.067	P=0.673	P=0.512	P=0.167
Cochran-Armitage test ^d	P=0.074			
Fisher exact test ^a		P=0.747N	P=0.500	P=0.187
Adrenal Medulla: Benign, Complex, or Malignant Pheochromocytoma				
Overall rate	2/49 (4%)	1/50 (2%)	3/49 (6%)	4/50 (8%)
Adjusted rate	7.1%	5.3%	10.3%	13.5%
Terminal rate	2/28 (7%)	1/19 (5%)	3/29 (10%)	1/23 (4%)
First incidence (days)	733 (T)	733 (T)	733 (T)	651
Life table test	P=0.145	P=0.635N	P=0.516	P=0.277
Logistic regression test	P=0.150	P=0.635N	P=0.516	P=0.310
Cochran-Armitage test	P=0.166			
Fisher exact test		P=0.492N	P=0.500	P=0.349
Clitoral Gland: Adenoma				
Overall rate	7/47 (15%)	4/46 (9%)	6/47 (13%)	2/48 (4%)
Adjusted rate	25.0%	19.3%	17.3%	9.1%
Terminal rate	6/26 (23%)	3/18 (17%)	3/28 (11%)	2/22 (9%)
First incidence (days)	631	636	619	733 (T)
Life table test	P=0.096N	P=0.474N	P=0.449N	P=0.117N
Logistic regression test	P=0.087N	P=0.386N	P=0.505N	P=0.102N
Cochran-Armitage test	P=0.082N			
Fisher exact test		P=0.274N	P=0.500N	P=0.074N
Clitoral Gland: Carcinoma				
Overall rate	0/47 (0%)	1/46 (2%)	3/47 (6%)	0/48 (0%)
Adjusted rate	0.0%	5.6%	10.7%	0.0%
Terminal rate	0/26 (0%)	1/18 (6%)	3/28 (11%)	0/22 (0%)
First incidence (days)	— ^e	733 (T)	733 (T)	—
Life table test	P=0.620	P=0.427	P=0.133	—
Logistic regression test	P=0.620	P=0.427	P=0.133	—
Cochran-Armitage test	P=0.626N			
Fisher exact test		P=0.495	P=0.121	—
Clitoral Gland: Adenoma or Carcinoma				
Overall rate	7/47 (15%)	5/46 (11%)	9/47 (19%)	2/48 (4%)
Adjusted rate	25.0%	24.7%	27.2%	9.1%
Terminal rate	6/26 (23%)	4/18 (22%)	6/28 (21%)	2/22 (9%)
First incidence (days)	631	636	619	733 (T)
Life table test	P=0.116N	P=0.625N	P=0.451	P=0.117N
Logistic regression test	P=0.106N	P=0.534N	P=0.387	P=0.102N
Cochran-Armitage test	P=0.099N			
Fisher exact test		P=0.395N	P=0.392	P=0.074N

TABLE B3
Statistical Analysis of Primary Neoplasms in Female Rats in the 2-Year Inhalation Study of Nitroethane (continued)

	0 ppm	94 ppm	188 ppm	375 ppm
Mammary Gland: Fibroadenoma	Overall rate 19/50 (38%)	Overall rate 21/50 (42%)	Overall rate 33/50 (66%)	Overall rate 36/50 (72%)
Adjusted rate	58.2%	68.5%	80.0%	92.1%
Terminal rate	15/28 (54%)	10/19 (53%)	22/30 (73%)	20/23 (87%)
First incidence (days)	454	435	468	552
Life table test	P < 0.001	P = 0.076	P = 0.015	P < 0.001
Logistic regression test	P < 0.001	P = 0.219	P = 0.003	P < 0.001
Cochran-Armitage test	P < 0.001	P = 0.419	P = 0.004	P < 0.001
Fisher exact test				
Mammary Gland: Fibroadenoma or Adenoma	Overall rate 20/50 (40%)	Overall rate 21/50 (42%)	Overall rate 33/50 (66%)	Overall rate 36/50 (72%)
Adjusted rate	61.4%	68.5%	80.0%	92.1%
Terminal rate	16/28 (57%)	10/19 (53%)	22/30 (73%)	20/23 (87%)
First incidence (days)	454	435	468	552
Life table test	P < 0.001	P = 0.101	P = 0.024	P < 0.001
Logistic regression test	P < 0.001	P = 0.278	P = 0.006	P < 0.001
Cochran-Armitage test	P < 0.001	P = 0.500	P = 0.008	P = 0.001
Fisher exact test				
Mammary Gland: Carcinoma	Overall rate 2/50 (4%)	Overall rate 7/50 (14%)	Overall rate 1/50 (2%)	Overall rate 11/50 (22%)
Adjusted rate	6.0%	29.3%	2.0%	33.0%
Terminal rate	1/28 (4%)	4/19 (21%)	0/30 (0%)	5/23 (22%)
First incidence (days)	631	588	440	425
Life table test	P = 0.009	P = 0.032	P = 0.489N	P = 0.006
Logistic regression test	P = 0.009	P = 0.052	P = 0.447N	P = 0.011
Cochran-Armitage test	P = 0.009	P = 0.080	P = 0.500N	P = 0.007
Fisher exact test				
Mammary Gland: Adenoma or Carcinoma	Overall rate 4/50 (8%)	Overall rate 7/50 (14%)	Overall rate 1/50 (2%)	Overall rate 13/50 (26%)
Adjusted rate	13.0%	29.3%	2.0%	40.5%
Terminal rate	3/28 (11%)	4/19 (21%)	0/30 (0%)	7/23 (30%)
First incidence (days)	631	588	440	425
Life table test	P = 0.009	P = 0.116	P = 0.169N	P = 0.009
Logistic regression test	P = 0.010	P = 0.176	P = 0.169N	P = 0.018
Cochran-Armitage test	P = 0.009	P = 0.262	P = 0.181N	P = 0.016
Fisher exact test				
Mammary Gland: Fibroadenoma, Adenoma, or Carcinoma	Overall rate 21/50 (42%)	Overall rate 25/50 (50%)	Overall rate 34/50 (68%)	Overall rate 41/50 (82%)
Adjusted rate	62.4%	74.9%	80.4%	95.2%
Terminal rate	16/28 (57%)	11/19 (58%)	22/30 (73%)	21/23 (91%)
First incidence (days)	454	435	440	425
Life table test	P < 0.001	P = 0.032	P = 0.028	P < 0.001
Logistic regression test	P < 0.001	P = 0.112	P = 0.006	P < 0.001
Cochran-Armitage test	P < 0.001	P = 0.274	P = 0.008	P < 0.001
Fisher exact test				

TABLE B3

Statistical Analysis of Primary Neoplasms in Female Rats in the 2-Year Inhalation Study of Nitromethane (continued)

	0 ppm	94 ppm	188 ppm	375 ppm
Pancreatic Islets: Adenoma				
Overall rate	1/50 (2%)	1/50 (2%)	3/50 (6%)	1/50 (2%)
Adjusted rate	3.6%	2.6%	10.0%	4.3%
Terminal rate	1/28 (4%)	0/19 (0%)	3/30 (10%)	1/23 (4%)
First incidence (days)	733 (T)	580	733 (T)	733 (T)
Life table test	P=0.536	P=0.706	P=0.329	P=0.718
Logistic regression test	P=0.546	P=0.756N	P=0.329	P=0.718
Cochran-Armitage test	P=0.555			
Fisher exact test		P=0.753N	P=0.309	P=0.753N
Pancreatic Islets: Adenoma or Carcinoma				
Overall rate	1/50 (2%)	2/50 (4%)	3/50 (6%)	1/50 (2%)
Adjusted rate	3.6%	4.6%	10.0%	4.3%
Terminal rate	1/28 (4%)	0/19 (0%)	3/30 (10%)	1/23 (4%)
First incidence (days)	733 (T)	488	733 (T)	733 (T)
Life table test	P=0.596N	P=0.440	P=0.329	P=0.718
Logistic regression test	P=0.579N	P=0.604	P=0.329	P=0.718
Cochran-Armitage test	P=0.578N			
Fisher exact test		P=0.500	P=0.309	P=0.753N
Pituitary Gland (Pars Distalis): Adenoma				
Overall rate	33/50 (66%)	36/50 (72%)	39/50 (78%)	40/50 (80%)
Adjusted rate	74.2%	91.8%	88.5%	88.5%
Terminal rate	17/28 (61%)	16/19 (84%)	25/30 (83%)	18/23 (78%)
First incidence (days)	454	488	468	425
Life table test	P=0.104	P=0.044	P=0.286	P=0.062
Logistic regression test	P=0.056	P=0.262	P=0.126	P=0.094
Cochran-Armitage test	P=0.063			
Fisher exact test		P=0.333	P=0.133	P=0.088
Pituitary Gland (Pars Distalis): Adenoma or Carcinoma				
Overall rate	33/50 (66%)	36/50 (72%)	40/50 (80%)	40/50 (80%)
Adjusted rate	74.2%	91.8%	90.8%	88.5%
Terminal rate	17/28 (61%)	16/19 (84%)	26/30 (87%)	18/23 (78%)
First incidence (days)	454	488	468	425
Life table test	P=0.100	P=0.044	P=0.236	P=0.062
Logistic regression test	P=0.051	P=0.262	P=0.082	P=0.094
Cochran-Armitage test	P=0.059			
Fisher exact test		P=0.333	P=0.088	P=0.088
Skin (Subcutaneous Tissue): Fibroma, Fibrosarcoma, or Sarcoma				
Overall rate	1/50 (2%)	3/50 (6%)	0/50 (0%)	3/50 (6%)
Adjusted rate	2.9%	11.5%	0.0%	10.0%
Terminal rate	0/28 (0%)	1/19 (5%)	0/30 (0%)	1/23 (4%)
First incidence (days)	691	579	—	387
Life table test	P=0.306	P=0.221	P=0.500N	P=0.256
Logistic regression test	P=0.329	P=0.292	P=0.501N	P=0.339
Cochran-Armitage test	P=0.325			
Fisher exact test		P=0.309	P=0.500N	P=0.309

TABLE B3

Statistical Analysis of Primary Neoplasms in Female Rats in the 2-Year Inhalation Study of Nitromethane (continued)

	0 ppm	94 ppm	188 ppm	375 ppm
Thyroid Gland (C-cell): Adenoma				
Overall rate	8/50 (16%)	9/50 (18%)	8/50 (16%)	10/49 (20%)
Adjusted rate	25.3%	33.8%	24.5%	34.2%
Terminal rate	6/28 (21%)	4/19 (21%)	6/30 (20%)	5/22 (23%)
First incidence (days)	600	561	657	634
Life table test	P=0.304	P=0.252	P=0.557N	P=0.260
Logistic regression test	P=0.322	P=0.399	P=0.608	P=0.320
Cochran-Armitage test	P=0.346			
Fisher exact test		P=0.500	P=0.607N	P=0.379
Thyroid Gland (C-cell): Carcinoma				
Overall rate	2/50 (4%)	0/50 (0%)	0/50 (0%)	3/49 (6%)
Adjusted rate	7.1%	0.0%	0.0%	11.8%
Terminal rate	2/28 (7%)	0/19 (0%)	0/30 (0%)	2/22 (9%)
First incidence (days)	733 (T)	—	—	660
Life table test	P=0.220	P=0.327N	P=0.223N	P=0.410
Logistic regression test	P=0.225	P=0.327N	P=0.223N	P=0.434
Cochran-Armitage test	P=0.240			
Fisher exact test		P=0.247N	P=0.247N	P=0.490
Thyroid Gland (C-cell): Adenoma or Carcinoma				
Overall rate	10/50 (20%)	9/50 (18%)	8/50 (16%)	12/49 (24%)
Adjusted rate	32.1%	33.8%	24.5%	42.0%
Terminal rate	8/28 (29%)	4/19 (21%)	6/30 (20%)	7/22 (32%)
First incidence (days)	600	561	657	634
Life table test	P=0.260	P=0.406	P=0.345N	P=0.235
Logistic regression test	P=0.278	P=0.581	P=0.394N	P=0.301
Cochran-Armitage test	P=0.306			
Fisher exact test		P=0.500N	P=0.398N	P=0.384
Uterus: Stromal Polyp				
Overall rate	6/50 (12%)	11/50 (22%)	6/50 (12%)	6/50 (12%)
Adjusted rate	19.8%	37.6%	18.3%	22.7%
Terminal rate	4/28 (14%)	4/19 (21%)	5/30 (17%)	4/23 (17%)
First incidence (days)	713	428	432	651
Life table test	P=0.409N	P=0.049	P=0.585N	P=0.485
Logistic regression test	P=0.362N	P=0.112	P=0.619	P=0.530
Cochran-Armitage test	P=0.354N			
Fisher exact test		P=0.143	P=0.620N	P=0.620N
Uterus: Stromal Polyp or Stromal Sarcoma				
Overall rate	6/50 (12%)	12/50 (24%)	6/50 (12%)	6/50 (12%)
Adjusted rate	19.8%	38.9%	18.3%	22.7%
Terminal rate	4/28 (14%)	4/19 (21%)	5/30 (17%)	4/23 (17%)
First incidence (days)	713	428	432	651
Life table test	P=0.374N	P=0.032	P=0.585N	P=0.485
Logistic regression test	P=0.298N	P=0.090	P=0.619	P=0.530
Cochran-Armitage test	P=0.320N			
Fisher exact test		P=0.096	P=0.620N	P=0.620N

TABLE B3
Statistical Analysis of Primary Neoplasms in Female Rats in the 2-Year Inhalation Study of Nitromethane (continued)

	0 ppm	94 ppm	188 ppm	375 ppm
All Organs: Mononuclear Cell Leukemia				
Overall rate	22/50 (44%)	13/50 (26%)	14/50 (28%)	9/50 (18%)
Adjusted rate	52.5%	38.1%	37.6%	27.2%
Terminal rate	9/28 (32%)	3/19 (16%)	8/30 (27%)	3/23 (13%)
First incidence (days)	519	428	512	597
Life table test	P=0.020N	P=0.268N	P=0.089N	P=0.030N
Logistic regression test	P=0.005N	P=0.033N	P=0.124N	P=0.001N
Cochran-Armitage test	P=0.007N			
Fisher exact test		P=0.046N	P=0.072N	P=0.004N
All Organs: Benign Neoplasms				
Overall rate	44/50 (88%)	47/50 (94%)	48/50 (96%)	49/50 (98%)
Adjusted rate	97.7%	100.0%	100.0%	100.0%
Terminal rate	27/28 (96%)	19/19 (100%)	30/30 (100%)	23/23 (100%)
First incidence (days)	454	428	432	425
Life table test	P=0.162	P=0.015	P=0.425	P=0.058
Logistic regression test	P=0.021	P=0.161	P=0.094	P=0.036
Cochran-Armitage test	P=0.035			
Fisher exact test		P=0.243	P=0.134	P=0.056
All Organs: Malignant Neoplasms				
Overall rate	28/50 (56%)	21/50 (42%)	20/50 (40%)	27/50 (54%)
Adjusted rate	63.0%	56.5%	49.8%	65.0%
Terminal rate	12/28 (43%)	6/19 (32%)	11/30 (37%)	10/23 (43%)
First incidence (days)	519	428	432	387
Life table test	P=0.435	P=0.518N	P=0.108N	P=0.412
Logistic regression test	P=0.513	P=0.086N	P=0.078N	P=0.455N
Cochran-Armitage test	P=0.501			
Fisher exact test		P=0.115N	P=0.080N	P=0.500N
All Organs: Benign or Malignant Neoplasms				
Overall rate	49/50 (98%)	50/50 (100%)	50/50 (100%)	50/50 (100%)
Adjusted rate	98.0%	100.0%	100.0%	100.0%
Terminal rate	27/28 (96%)	19/19 (100%)	30/30 (100%)	23/23 (100%)
First incidence (days)	454	428	432	387
Life table test	P=0.347	P=0.034	P=0.513N	P=0.170
Logistic regression test	P=0.313	P=0.577	P=0.486	P=0.539
Cochran-Armitage test	P=0.304			
Fisher exact test		P=0.500	P=0.500	P=0.500

(T)Terminal sacrifice

^a Number of neoplasm-bearing animals/number of animals examined. Denominator is number of animals examined microscopically for adrenal gland, clitoral gland, pancreatic islets, pituitary gland, thyroid gland, and uterus; for other tissues, denominator is number of animals necropsied.

^b Kaplan-Meier estimated neoplasm incidence at the end of the study after adjustment for intercurrent mortality

^c Observed incidence at terminal kill

^d Beneath the control incidence are the P values associated with the trend test. Beneath the exposed group incidence are the P values corresponding to pairwise comparisons between the controls and that exposed group. The life table test regards neoplasms in animals dying prior to terminal kill as being (directly or indirectly) the cause of death. The logistic regression test regards these lesions as nonfatal. The Cochran-Armitage and Fisher exact tests compare directly the overall incidence rates. For all tests, a negative trend or a lower incidence in an exposure group is indicated by N.

^e Not applicable; no neoplasms in animal group

TABLE B4
Historical Incidence of Mammary Gland Neoplasms in Chamber Control Female F344/N Rats^a

Study	Incidence in Controls			
	Fibroadenoma	Adenoma	Carcinoma	Fibroadenoma, Adenoma, or Carcinoma
Historical Incidence at Battelle Pacific Northwest Laboratories				
<i>o</i> -Chlorobenzalmalononitrile (CS2)	16/50	0/50	1/50	17/50
Acetonitrile	16/48	0/48	2/48	17/48
2-Chloroacetophenone	12/50	0/50	2/50	13/50
<i>l</i> -Epinephrine Hydrochloride	10/50	0/50	2/50	11/50
Chloroethane	11/50	2/50	0/50	13/50
Hexachlorocyclopentadiene	12/50	0/50	3/50	14/50
Ozone	20/50	1/50	4/50	23/50
Total	97/348 (27.9%)	3/348 (0.9%)	14/348 (4.0%)	108/348 (31.0%)
Standard deviation	7.3%	1.6%	2.6%	8.1%
Range	20%-40%	0%-4%	0%-8%	22%-46%
Overall Historical Incidence				
Total	180/653 (27.6%)	8/653 (1.2%)	25/653 (3.8%)	202/653 (30.9%)
Standard deviation	7.7%	1.5%	2.7%	9.1%
Range	16%-42%	0%-4%	0%-8%	16%-46%

^a Data as of 12 May 1995

TABLE B5
Summary of the Incidence of Nonneoplastic Lesions in Female Rats in the 2-Year Inhalation Study of Nitromethane^a

	0 ppm	94 ppm	188 ppm	375 ppm
Disposition Summary				
Animals initially in study	50	50	50	50
Early deaths				
Moribund	17	26	18	25
Natural deaths	5	5	2	2
Survivors				
Terminal sacrifice	28	19	30	23
Animals examined microscopically	50	50	50	50
Alimentary System				
Liver	(50)	(50)	(50)	(50)
Angiectasis	2 (4%)	1 (2%)	4 (8%)	5 (10%)
Basophilic focus	41 (82%)	42 (84%)	41 (82%)	41 (82%)
Clear cell focus	6 (12%)	9 (18%)	9 (18%)	7 (14%)
Degeneration, cystic	1 (2%)		1 (2%)	
Degeneration, fatty	9 (18%)	7 (14%)	8 (16%)	5 (10%)
Eosinophilic focus	2 (4%)	2 (4%)	1 (2%)	1 (2%)
Hepatodiaphragmatic nodule	7 (14%)	4 (8%)	3 (6%)	5 (10%)
Inflammation, granulomatous	1 (2%)			1 (2%)
Mixed cell focus	12 (24%)	15 (30%)	11 (22%)	17 (34%)
Necrosis	1 (2%)			1 (2%)
Regeneration	2 (4%)			
Bile duct, hyperplasia	10 (20%)	7 (14%)	12 (24%)	9 (18%)
Centrilobular, necrosis	1 (2%)			
Mesentery	(10)	(11)	(12)	(14)
Fat, necrosis	7 (70%)	10 (91%)	10 (83%)	11 (79%)
Pancreas	(50)	(50)	(50)	(50)
Atrophy	20 (40%)	15 (30%)	20 (40%)	24 (48%)
Basophilic focus	1 (2%)	2 (4%)	2 (4%)	1 (2%)
Hyperplasia	1 (2%)			1 (2%)
Metaplasia, hepatocyte		1 (2%)		
Artery, inflammation	1 (2%)			1 (2%)
Salivary glands	(50)	(50)	(50)	(50)
Atrophy	1 (2%)	1 (2%)	1 (2%)	
Basophilic focus		2 (4%)		
Stomach, forestomach	(50)	(50)	(50)	(50)
Diverticulum			1 (2%)	
Hyperplasia, squamous			1 (2%)	
Inflammation, acute	2 (4%)	1 (2%)	4 (8%)	1 (2%)
Mineralization				1 (2%)
Necrosis	4 (8%)	3 (6%)	5 (10%)	6 (12%)
Stomach, glandular	(50)	(50)	(50)	(50)
Inflammation, acute			1 (2%)	
Mineralization	1 (2%)	1 (2%)	1 (2%)	1 (2%)
Necrosis	2 (4%)	1 (2%)	1 (2%)	2 (4%)
Tooth		(1)		
Inflammation, chronic active		1 (100%)		

^a Number of animals examined microscopically at the site and the number of animals with lesion

TABLE B5
Summary of the Incidence of Nonneoplastic Lesions in Female Rats in the 2-Year Inhalation Study of Nitromethane
 (continued)

	0 ppm	94 ppm	188 ppm	375 ppm
Cardiovascular System				
Heart	(50)	(50)	(50)	(50)
Cardiomyopathy	42 (84%)	31 (62%)	34 (68%)	39 (78%)
Artery, mineralization		1 (2%)		
Atrium, thrombosis				1 (2%)
Endocrine System				
Adrenal cortex	(50)	(50)	(50)	(50)
Angiectasis				1 (2%)
Hematopoietic cell proliferation		1 (2%)		
Hyperplasia	6 (12%)	15 (30%)	12 (24%)	13 (26%)
Hypertrophy	16 (32%)	12 (24%)	14 (28%)	12 (24%)
Necrosis				1 (2%)
Vacuolization cytoplasmic		1 (2%)		2 (4%)
Adrenal medulla	(49)	(50)	(49)	(50)
Hyperplasia	3 (6%)	4 (8%)	9 (18%)	8 (16%)
Islets, pancreatic	(50)	(50)	(50)	(50)
Hyperplasia	2 (4%)			
Parathyroid gland	(50)	(49)	(50)	(48)
Hyperplasia	1 (2%)	1 (2%)		
Pituitary gland	(50)	(50)	(50)	(50)
Hyperplasia		1 (2%)		
Pars distalis, angiectasis	1 (2%)			
Pars distalis, hyperplasia	13 (26%)	8 (16%)	9 (18%)	9 (18%)
Thyroid gland	(50)	(50)	(50)	(49)
C-cell, hyperplasia	41 (82%)	47 (94%)	49 (98%)	42 (86%)
General Body System				
None				
Genital System				
Clitoral gland	(47)	(46)	(47)	(48)
Hyperplasia				1 (2%)
Inflammation, chronic active	4 (9%)	6 (13%)	4 (9%)	2 (4%)
Ovary	(50)	(50)	(50)	(50)
Cyst	1 (2%)	2 (4%)	5 (10%)	3 (6%)
Inflammation, granulomatous			1 (2%)	
Uterus	(50)	(50)	(50)	(50)
Cyst	1 (2%)			
Hydrometra			1 (2%)	
Hyperplasia	1 (2%)			

TABLE B5

Summary of the Incidence of Nonneoplastic Lesions in Female Rats in the 2-Year Inhalation Study of Nitromethane
(continued)

	0 ppm	94 ppm	188 ppm	375 ppm
Hematopoietic System				
Bone marrow	(50)	(50)	(50)	(50)
Hyperplasia, reticulum cell	1 (2%)	2 (4%)	1 (2%)	2 (4%)
Lymph node	(7)	(6)	(9)	(3)
Iliac, pigmentation	1 (14%)			1 (33%)
Pancreatic, hemorrhage		1 (17%)	1 (11%)	
Pancreatic, infiltration cellular, eosinophil				1 (33%)
Pancreatic, inflammation, granulomatous				1 (33%)
Renal, hemorrhage	1 (14%)		1 (11%)	1 (33%)
Renal, pigmentation			1 (11%)	
Lymph node, bronchial	(48)	(49)	(47)	(48)
Infiltration cellular, eosinophil				1 (2%)
Inflammation, granulomatous				1 (2%)
Lymph node, mandibular	(49)	(48)	(48)	(47)
Hemorrhage				1 (2%)
Infiltration cellular, plasma cell			2 (4%)	1 (2%)
Lymph node, mesenteric	(50)	(50)	(49)	(50)
Hemorrhage	1 (2%)	1 (2%)		1 (2%)
Infiltration cellular, eosinophil				1 (2%)
Inflammation, granulomatous				1 (2%)
Lymph node, mediastinal	(48)	(49)	(50)	(46)
Hemorrhage	1 (2%)	3 (6%)	1 (2%)	2 (4%)
Inflammation, granulomatous		1 (2%)		
Spleen	(50)	(49)	(50)	(50)
Fibrosis	2 (4%)	1 (2%)	4 (8%)	1 (2%)
Hematopoietic cell proliferation		3 (6%)		2 (4%)
Thrombosis	1 (2%)	1 (2%)		
Integumentary System				
Mammary gland	(50)	(50)	(50)	(50)
Galactocele	3 (6%)	1 (2%)	3 (6%)	7 (14%)
Hyperplasia			1 (2%)	
Hyperplasia, atypical	12 (24%)	17 (34%)	14 (28%)	15 (30%)
Hyperplasia, lobular				2 (4%)
Inflammation, granulomatous		1 (2%)		
Inflammation, suppurative		1 (2%)	1 (2%)	
Skin	(50)	(50)	(48)	(49)
Hyperkeratosis		1 (2%)		
Inflammation, acute	1 (2%)			
Inflammation, chronic active	1 (2%)	2 (4%)		1 (2%)
Inflammation, granulomatous		1 (2%)		
Sebaceous gland, hypertrophy		1 (2%)		
Vulva, inflammation, acute			1 (2%)	
Musculoskeletal System				
Bone	(50)	(50)	(50)	(50)
Fibrous osteodystrophy		1 (2%)		
Hyperostosis	3 (6%)	1 (2%)		1 (2%)
Cranium, hyperostosis			1 (2%)	
Femur, hyperostosis			1 (2%)	

TABLE B5

Summary of the Incidence of Nonneoplastic Lesions in Female Rats in the 2-Year Inhalation Study of Nitromethane
(continued)

	0 ppm	94 ppm	188 ppm	375 ppm
Nervous System				
Brain	(50)	(50)	(50)	(50)
Hemorrhage	1 (2%)	2 (4%)		1 (2%)
Hydrocephalus	1 (2%)	1 (2%)	1 (2%)	
Respiratory System				
Larynx	(50)	(50)	(50)	(49)
Metaplasia, squamous	1 (2%)	2 (4%)	1 (2%)	2 (4%)
Lung	(50)	(50)	(50)	(50)
Congestion			1 (2%)	
Fibrosis, focal		1 (2%)		
Fibrosis, multifocal				1 (2%)
Hemorrhage		1 (2%)	1 (2%)	1 (2%)
Inflammation, chronic active	2 (4%)	2 (4%)	1 (2%)	1 (2%)
Mineralization		1 (2%)		
Alveolar epithelium, hyperplasia	6 (12%)	11 (22%)	7 (14%)	7 (14%)
Artery, mediastinum, inflammation				1 (2%)
Artery, mediastinum, mineralization		1 (2%)		
Bronchiole, hyperplasia		1 (2%)		
Bronchiole, metaplasia				1 (2%)
Nose	(50)	(50)	(50)	(50)
Inflammation, chronic active		3 (6%)	2 (4%)	
Inflammation, suppurative	4 (8%)	2 (4%)		
Thrombosis		1 (2%)		1 (2%)
Nasolacrimal duct, inflammation, suppurative	5 (10%)	4 (8%)	6 (12%)	2 (4%)
Special Senses System				
Eye	(2)	(1)	(2)	(4)
Cataract	1 (50%)		1 (50%)	3 (75%)
Degeneration	1 (50%)	1 (100%)		1 (25%)
Retina, atrophy				1 (25%)
Harderian gland	(3)			
Hemorrhage	1 (33%)			
Urinary System				
Kidney	(50)	(50)	(50)	(50)
Infarct	1 (2%)			1 (2%)
Mineralization		1 (2%)		
Nephropathy	49 (98%)	49 (98%)	48 (96%)	49 (98%)
Renal tubule, hyperplasia		1 (2%)		1 (2%)
Urinary bladder	(50)	(50)	(49)	(50)
Transitional epithelium, hyperplasia	1 (2%)			

APPENDIX C
SUMMARY OF LESIONS IN MALE MICE
IN THE 2-YEAR INHALATION STUDY
OF NITROMETHANE

TABLE C1	Summary of the Incidence of Neoplasms in Male Mice in the 2-Year Inhalation Study of Nitromethane	153
TABLE C2	Individual Animal Tumor Pathology of Male Mice in the 2-Year Inhalation Study of Nitromethane	156
TABLE C3	Statistical Analysis of Primary Neoplasms in Male Mice in the 2-Year Inhalation Study of Nitromethane	176
TABLE C4a	Historical Incidence of Harderian Gland Neoplasms in Chamber Control Male B6C3F ₁ Mice	180
TABLE C4b	Historical Incidence of Alveolar/bronchiolar Neoplasms in Chamber Control Male B6C3F ₁ Mice	181
TABLE C5	Summary of the Incidence of Nonneoplastic Lesions in Male Mice in the 2-Year Inhalation Study of Nitromethane	182

TABLE C1
Summary of the Incidence of Neoplasms in Male Mice in the 2-Year Inhalation Study of Nitromethane^a

	0 ppm	188 ppm	375 ppm	750 ppm
Disposition Summary				
Animals initially in study	50	50	50	50
Early deaths				
Moribund	14	11	16	16
Natural deaths	5	3	4	5
Survivors				
Terminal sacrifice	31	36	30	29
Animals examined microscopically	50	50	50	50
Alimentary System				
Intestine small, jejunum	(45)	(49)	(47)	(46)
Intestine small, ileum	(46)	(48)	(46)	(45)
Liver	(50)	(50)	(50)	(50)
Hemangiosarcoma	1 (2%)	2 (4%)	2 (4%)	
Hepatocellular carcinoma	11 (22%)	12 (24%)	8 (16%)	6 (12%)
Hepatocellular carcinoma, multiple	5 (10%)	2 (4%)	2 (4%)	3 (6%)
Hepatocellular adenoma	10 (20%)	10 (20%)	12 (24%)	11 (22%)
Hepatocellular adenoma, multiple	7 (14%)	4 (8%)	1 (2%)	6 (12%)
Hepatocholangiocarcinoma, multiple	1 (2%)			
Histiocytic sarcoma			3 (6%)	
Squamous cell carcinoma, metastatic, stomach, forestomach		1 (2%)		
Mesentery	(3)		(6)	(2)
Fat, histiocytic sarcoma			2 (33%)	
Pancreas	(49)	(50)	(49)	(49)
Adenoma		1 (2%)		
Histiocytic sarcoma			2 (4%)	
Salivary glands	(50)	(49)	(50)	(49)
Stomach, forestomach	(49)	(50)	(50)	(48)
Histiocytic sarcoma			1 (2%)	
Squamous cell carcinoma		1 (2%)		
Squamous cell papilloma		1 (2%)		1 (2%)
Stomach, glandular	(48)	(48)	(48)	(48)
Histiocytic sarcoma			1 (2%)	
Cardiovascular System				
Heart	(50)	(50)	(50)	(50)
Hepatocellular carcinoma, metastatic, liver	1 (2%)			
Endocrine System				
Adrenal cortex	(49)	(50)	(49)	(48)
Adenoma				2 (4%)
Bilateral, capsule, adenoma			1 (2%)	
Capsule, adenoma	5 (10%)	1 (2%)	1 (2%)	3 (6%)
Adrenal medulla	(49)	(50)	(49)	(47)
Pheochromocytoma complex			1 (2%)	
Pheochromocytoma benign				1 (2%)
Islets, pancreatic	(49)	(50)	(49)	(49)
Adenoma	1 (2%)	3 (6%)		1 (2%)

TABLE C1

Summary of the Incidence of Neoplasms in Male Mice in the 2-Year Inhalation Study of Nitromethane (continued)

	0 ppm	188 ppm	375 ppm	750 ppm
Endocrine System (continued)				
Pituitary gland	(47)	(50)	(46)	(47)
Pars distalis, adenoma	1 (2%)			
Pars intermedia, adenoma			1 (2%)	
Thyroid gland	(50)	(50)	(49)	(48)
Follicular cell, adenoma	1 (2%)			1 (2%)
Follicular cell, carcinoma		1 (2%)		
General Body System				
None				
Genital System				
Epididymis	(50)	(50)	(50)	(49)
Histiocytic sarcoma	2 (4%)			
Prostate	(49)	(50)	(47)	(46)
Histiocytic sarcoma			1 (2%)	
Seminal vesicle	(49)	(49)	(49)	(47)
Histiocytic sarcoma			1 (2%)	
Testes	(50)	(50)	(50)	(50)
Interstitial cell, adenoma	2 (4%)	1 (2%)	1 (2%)	1 (2%)
Hematopoietic System				
Bone marrow	(49)	(50)	(50)	(50)
Hemangiosarcoma	1 (2%)	2 (4%)		
Lymph node	(3)	(1)	(1)	(2)
Lymph node, bronchial	(26)	(26)	(24)	(28)
Histiocytic sarcoma			1 (4%)	
Lymph node, mandibular	(40)	(39)	(37)	(43)
Lymph node, mesenteric	(47)	(46)	(47)	(49)
Histiocytic sarcoma			2 (4%)	1 (2%)
Lymph node, mediastinal	(35)	(37)	(36)	(40)
Histiocytic sarcoma			1 (3%)	
Spleen	(49)	(50)	(50)	(49)
Hemangiosarcoma	1 (2%)	1 (2%)	1 (2%)	
Histiocytic sarcoma			1 (2%)	1 (2%)
Thymus	(33)	(34)	(33)	(40)
Integumentary System				
Skin	(49)	(49)	(49)	(48)
Prepuce, histiocytic sarcoma	1 (2%)			
Subcutaneous tissue, hemangiosarcoma			1 (2%)	
Subcutaneous tissue, histiocytic sarcoma	2 (4%)			
Musculoskeletal System				
None				

TABLE C1

Summary of the Incidence of Neoplasms in Male Mice in the 2-Year Inhalation Study of Nitromethane (continued)

	0 ppm	188 ppm	375 ppm	750 ppm
Nervous System				
Brain	(50)	(50)	(50)	(49)
Carcinoma, metastatic, harderian gland			1 (2%)	
Respiratory System				
Lung	(50)	(50)	(50)	(50)
Alveolar/bronchiolar adenoma	9 (18%)	10 (20%)	8 (16%)	11 (22%)
Alveolar/bronchiolar adenoma, multiple	2 (4%)		1 (2%)	1 (2%)
Alveolar/bronchiolar carcinoma	2 (4%)	3 (6%)	3 (6%)	10 (20%)
Alveolar/bronchiolar carcinoma, multiple				1 (2%)
Carcinoma, metastatic, harderian gland			1 (2%)	2 (4%)
Hepatocellular carcinoma, metastatic, liver	6 (12%)	1 (2%)	4 (8%)	2 (4%)
Histiocytic sarcoma			1 (2%)	
Mediastinum, histiocytic sarcoma			1 (2%)	
Nose	(50)	(49)	(50)	(50)
Carcinoma, metastatic, harderian gland			1 (2%)	1 (2%)
Special Senses System				
Harderian gland	(49)	(50)	(50)	(49)
Adenoma	9 (18%)	6 (12%)	18 (36%)	25 (51%)
Adenoma, multiple		4 (8%)	1 (2%)	7 (14%)
Carcinoma	1 (2%)	1 (2%)	6 (12%)	4 (8%)
Carcinoma, multiple				1 (2%)
Urinary System				
Kidney	(50)	(50)	(49)	(49)
Renal tubule, adenoma			1 (2%)	
Urinary bladder	(48)	(50)	(49)	(48)
Systemic Lesions				
Multiple organs ^b	(50)	(50)	(50)	(50)
Histiocytic sarcoma	3 (6%)		3 (6%)	1 (2%)
Lymphoma malignant	3 (6%)	4 (8%)	2 (4%)	1 (2%)
Neoplasm Summary				
Total animals with primary neoplasms ^c	40	39	43	46
Total primary neoplasms	76	70	75	98
Total animals with benign neoplasms	31	31	33	43
Total benign neoplasms	47	41	46	71
Total animals with malignant neoplasms	22	25	24	22
Total malignant neoplasms	29	29	29	27
Total animals with metastatic neoplasms	6	2	5	4
Total metastatic neoplasms	7	2	7	5

^a Number of animals examined microscopically at the site and the number of animals with neoplasm^b Number of animals with any tissue examined microscopically^c Primary neoplasms: all neoplasms except metastatic neoplasms

TABLE C2
Individual Animal Tumor Pathology of Male Mice in the 2-Year Inhalation Study of Nitromethane: 0 ppm

	4	4	4	5	5	5	5	5	5	6	6	6	6	6	6	6	7	7	7	7	7	7	7	7	7		
Number of Days on Study	4	4	9	0	0	3	4	7	8	0	2	5	5	5	5	6	0	1	3	3	3	3	3	3	3		
	1	9	0	3	3	4	5	6	1	9	3	3	3	3	3	5	1	4	1	4	4	4	4	4	4		
Carcass ID Number	0	0	0	0	0	0	0	0	0	0	0	0	0	0	0	0	0	0	0	0	0	0	0	0	0		
	1	4	3	1	2	1	1	3	4	3	4	0	1	3	4	4	4	1	2	0	0	0	2	2	2		
	3	2	1	8	4	0	5	3	7	6	6	2	2	9	8	5	1	9	3	1	8	9	0	7	9		
Alimentary System																											
Esophagus	+	+	+	+	+	+	+	+	+	+	+	+	+	+	+	+	+	+	+	+	+	+	+	+	+	+	
Gallbladder	+	+	A	+	+	+	A	M	+	A	+	+	+	+	+	+	+	A	+	+	+	+	+	+	+	+	
Intestine large, colon	+	+	A	+	+	+	+	+	+	A	+	+	+	+	+	+	+	+	+	+	+	+	+	+	+	+	
Intestine large, rectum	+	+	A	+	+	+	+	+	+	A	+	+	+	+	+	+	+	+	+	M	+	+	+	+	+	+	
Intestine large, cecum	+	+	A	+	+	+	+	+	+	A	+	+	A	+	+	+	+	A	+	+	+	+	+	+	+	+	
Intestine small, duodenum	+	+	A	+	+	+	A	+	+	M	+	+	A	+	+	+	+	M	+	+	+	+	+	+	+	+	
Intestine small, jejunum	+	+	A	+	+	+	A	+	+	A	+	+	A	+	+	+	+	A	+	+	+	+	+	+	+	+	
Intestine small, ileum	+	+	A	+	+	+	A	+	+	A	+	+	+	+	+	+	+	A	+	+	+	+	+	+	+	+	
Liver	+	+	+	+	+	+	+	+	+	+	+	+	+	+	+	+	+	+	+	+	+	+	+	+	+	+	
Hemangiosarcoma																									X		
Hepatocellular carcinoma	X			X		X			X	X	X			X													
Hepatocellular carcinoma, multiple					X			X				X		X													
Hepatocellular adenoma		X	X			X							X													X	
Hepatocellular adenoma, multiple							X												X								
Hepatocholangiocarcinoma, multiple																											
Mesentery								+																			
Pancreas	+	+	A	+	+	+	+	+	+	+	+	+	+	+	+	+	+	+	+	+	+	+	+	+	+	+	
Salivary glands	+	+	+	+	+	+	+	+	+	+	+	+	+	+	+	+	+	+	+	+	+	+	+	+	+	+	
Stomach, forestomach	+	+	A	+	+	+	+	+	+	+	+	+	+	+	+	+	+	+	+	+	+	+	+	+	+	+	
Stomach, glandular	+	+	A	+	+	+	+	+	+	A	+	+	+	+	+	+	+	+	+	+	+	+	+	+	+	+	
Tooth																										+	
Cardiovascular System																											
Heart	+	+	+	+	+	+	+	+	+	+	+	+	+	+	+	+	+	+	+	+	+	+	+	+	+	+	
Hepatocellular carcinoma, metastatic, liver																										X	
Endocrine System																											
Adrenal cortex	+	+	A	+	+	+	+	+	+	+	+	+	+	+	+	+	+	+	+	+	+	+	+	+	+	+	
Capsule, adenoma																										X	
Adrenal medulla	+	+	A	+	+	+	+	+	+	+	+	+	+	+	+	+	+	+	+	+	+	+	+	+	+	+	
Islets, pancreatic	+	+	A	+	+	+	+	+	+	+	+	+	+	+	+	+	+	+	+	+	+	+	+	+	+	+	
Adenoma																										X	
Parathyroid gland	+	+	+	+	+	M	+	+	+	+	+	+	+	+	+	+	+	M	+	M	+	+	+	M	+	+	
Pituitary gland	+	+	+	+	+	+	+	+	+	+	+	+	+	+	+	+	+	+	+	+	+	+	+	+	+	+	
Pars distalis, adenoma																										X	
Thyroid gland	+	+	+	+	+	+	+	+	+	+	+	+	+	+	+	+	+	+	+	+	+	+	+	+	+	+	
Follicular cell, adenoma																										X	
General Body System																											
None																											

+: Tissue examined microscopically
A: Autolysis precludes examination

M: Missing tissue
I: Insufficient tissue

X: Lesion present
Blank: Not examined

TABLE C2
Individual Animal Tumor Pathology of Male Mice in the 2-Year Inhalation Study of Nitromethane: 188 ppm (continued)

Table with columns: Number of Days on Study, Carcass ID Number, and various organ systems (Alimentary, Cardiovascular, Endocrine, General Body, Genital). Rows include specific lesions like Esophagus, Gallbladder, Hemangiosarcoma, etc., with counts and symbols (+, X, M).

TABLE C3
Statistical Analysis of Primary Neoplasms in Male Mice in the 2-Year Inhalation Study of Nitromethane

	0 ppm	188 ppm	375 ppm	750 ppm
Adrenal Cortex: Adenoma				
Overall rate ^a	5/49 (10%)	1/50 (2%)	2/49 (4%)	5/48 (10%)
Adjusted rate ^b	16.1%	2.8%	6.7%	16.4%
Terminal rate ^c	5/31 (16%)	1/36 (3%)	2/30 (7%)	4/28 (14%)
First incidence (days)	734 (T)	734 (T)	734 (T)	649
Life table test ^d	P=0.324	P=0.071N	P=0.226N	P=0.576
Logistic regression test ^d	P=0.356	P=0.071N	P=0.226N	P=0.620
Cochran-Armitage test ^d	P=0.389			
Fisher exact test ^d		P=0.098N	P=0.218N	P=0.617
Harderian Gland: Adenoma				
Overall rate	9/50 (18%)	10/50 (20%)	19/50 (38%)	32/50 (64%)
Adjusted rate	26.6%	22.8%	51.9%	75.5%
Terminal rate	7/31 (23%)	4/36 (11%)	13/30 (43%)	19/29 (66%)
First incidence (days)	545	448	520	497
Life table test	P<0.001	P=0.555N	P=0.023	P<0.001
Logistic regression test	P<0.001	P=0.505	P=0.019	P<0.001
Cochran-Armitage test	P<0.001			
Fisher exact test		P=0.500	P=0.022	P<0.001
Harderian Gland: Carcinoma				
Overall rate	1/50 (2%)	1/50 (2%)	6/50 (12%)	5/50 (10%)
Adjusted rate	2.6%	2.8%	16.5%	14.7%
Terminal rate	0/31 (0%)	1/36 (3%)	3/30 (10%)	3/29 (10%)
First incidence (days)	653	734 (T)	436	595
Life table test	P=0.031	P=0.730N	P=0.060	P=0.108
Logistic regression test	P=0.036	P=0.762N	P=0.062	P=0.104
Cochran-Armitage test	P=0.036			
Fisher exact test		P=0.753N	P=0.056	P=0.102
Harderian Gland: Adenoma or Carcinoma				
Overall rate	10/50 (20%)	11/50 (22%)	25/50 (50%)	37/50 (74%)
Adjusted rate	28.4%	25.3%	63.2%	83.7%
Terminal rate	7/31 (23%)	5/36 (14%)	16/30 (53%)	22/29 (76%)
First incidence (days)	545	448	436	497
Life table test	P<0.001	P=0.540N	P=0.003	P<0.001
Logistic regression test	P<0.001	P=0.506	P=0.001	P<0.001
Cochran-Armitage test	P<0.001			
Fisher exact test		P=0.500	P=0.002	P<0.001
Liver: Hepatocellular Adenoma				
Overall rate	17/50 (34%)	14/50 (28%)	13/50 (26%)	17/50 (34%)
Adjusted rate	44.2%	38.9%	36.2%	52.5%
Terminal rate	11/31 (35%)	14/36 (39%)	8/30 (27%)	14/29 (48%)
First incidence (days)	449	734 (T)	436	679
Life table test	P=0.352	P=0.196N	P=0.300N	P=0.522
Logistic regression test	P=0.484	P=0.292N	P=0.261N	P=0.562N
Cochran-Armitage test	P=0.490			
Fisher exact test		P=0.333N	P=0.257N	P=0.583N

TABLE C3
Statistical Analysis of Primary Neoplasms in Male Mice in the 2-Year Inhalation Study of Nitromethane (continued)

	0 ppm	188 ppm	375 ppm	750 ppm
Liver: Hepatocellular Carcinoma				
Overall rate	16/50 (32%)	14/50 (28%)	10/50 (20%)	9/50 (18%)
Adjusted rate	35.6%	33.3%	21.9%	20.7%
Terminal rate	5/31 (16%)	9/36 (25%)	1/30 (3%)	2/29 (7%)
First incidence (days)	441	448	377	406
Life table test	P=0.085N	P=0.297N	P=0.177N	P=0.104N
Logistic regression test	P=0.032N	P=0.440	P=0.120N	P=0.099N
Cochran-Armitage test	P=0.051N			
Fisher exact test		P=0.414N	P=0.127N	P=0.083N
Liver: Hepatocellular Adenoma or Carcinoma				
Overall rate	29/50 (58%)	24/50 (48%)	22/50 (44%)	26/50 (52%)
Adjusted rate	60.6%	58.0%	48.4%	64.9%
Terminal rate	13/31 (42%)	19/36 (53%)	8/30 (27%)	16/29 (55%)
First incidence (days)	441	448	377	406
Life table test	P=0.502N	P=0.119N	P=0.210N	P=0.405N
Logistic regression test	P=0.319N	P=0.268N	P=0.111N	P=0.383N
Cochran-Armitage test	P=0.360N			
Fisher exact test		P=0.212N	P=0.115N	P=0.344N
Lung: Alveolar/bronchiolar Adenoma				
Overall rate	11/50 (22%)	10/50 (20%)	9/50 (18%)	12/50 (24%)
Adjusted rate	30.8%	26.0%	30.0%	35.1%
Terminal rate	8/31 (26%)	8/36 (22%)	9/30 (30%)	8/29 (28%)
First incidence (days)	449	646	734 (T)	497
Life table test	P=0.322	P=0.365N	P=0.433N	P=0.456
Logistic regression test	P=0.422	P=0.456N	P=0.412N	P=0.511
Cochran-Armitage test	P=0.430			
Fisher exact test		P=0.500N	P=0.402N	P=0.500
Lung: Alveolar/bronchiolar Carcinoma				
Overall rate	2/50 (4%)	3/50 (6%)	3/50 (6%)	11/50 (22%)
Adjusted rate	6.5%	8.3%	10.0%	30.4%
Terminal rate	2/31 (6%)	3/36 (8%)	3/30 (10%)	6/29 (21%)
First incidence (days)	734 (T)	734 (T)	734 (T)	586
Life table test	P<0.001	P=0.569	P=0.485	P=0.009
Logistic regression test	P=0.001	P=0.569	P=0.485	P=0.009
Cochran-Armitage test	P=0.001			
Fisher exact test		P=0.500	P=0.500	P=0.007
Lung: Alveolar/bronchiolar Adenoma or Carcinoma				
Overall rate	13/50 (26%)	13/50 (26%)	12/50 (24%)	20/50 (40%)
Adjusted rate	36.8%	33.9%	40.0%	51.2%
Terminal rate	10/31 (32%)	11/36 (31%)	12/30 (40%)	11/29 (38%)
First incidence (days)	449	646	734 (T)	497
Life table test	P=0.032	P=0.427N	P=0.540N	P=0.099
Logistic regression test	P=0.059	P=0.517N	P=0.515N	P=0.105
Cochran-Armitage test	P=0.063			
Fisher exact test		P=0.590N	P=0.500N	P=0.101

TABLE C3
Statistical Analysis of Primary Neoplasms in Male Mice in the 2-Year Inhalation Study of Nitromethane (continued)

	0 ppm	188 ppm	375 ppm	750 ppm
Pancreatic Islets: Adenoma				
Overall rate	1/49 (2%)	3/50 (6%)	0/49 (0%)	1/49 (2%)
Adjusted rate	2.2%	7.8%	0.0%	2.4%
Terminal rate	0/31 (0%)	2/36 (6%)	0/30 (0%)	0/29 (0%)
First incidence (days)	534	679	— ^e	632
Life table test	P=0.421N	P=0.356	P=0.500N	P=0.747N
Logistic regression test	P=0.416N	P=0.300	P=0.425N	P=0.734
Cochran-Armitage test	P=0.412N			
Fisher exact test		P=0.316	P=0.500N	P=0.753N
All Organs: Hemangiosarcoma				
Overall rate	1/50 (2%)	4/50 (8%)	2/50 (4%)	0/50 (0%)
Adjusted rate	3.2%	10.6%	6.7%	0.0%
Terminal rate	1/31 (3%)	3/36 (8%)	2/30 (7%)	0/29 (0%)
First incidence (days)	734 (T)	721	734 (T)	—
Life table test	P=0.231N	P=0.234	P=0.488	P=0.513N
Logistic regression test	P=0.222N	P=0.235	P=0.488	P=0.513N
Cochran-Armitage test	P=0.199N			
Fisher exact test		P=0.181	P=0.500	P=0.500N
All Organs: Histiocytic Sarcoma				
Overall rate	3/50 (6%)	0/50 (0%)	3/50 (6%)	1/50 (2%)
Adjusted rate	8.7%	0.0%	8.6%	3.4%
Terminal rate	1/31 (3%)	0/36 (0%)	1/30 (3%)	1/29 (3%)
First incidence (days)	653	—	563	734 (T)
Life table test	P=0.405N	P=0.101N	P=0.648	P=0.326N
Logistic regression test	P=0.373N	P=0.110N	P=0.659	P=0.297N
Cochran-Armitage test	P=0.372N			
Fisher exact test		P=0.121N	P=0.661N	P=0.309N
All Organs: Malignant Lymphoma				
Overall rate	3/50 (6%)	4/50 (8%)	2/50 (4%)	1/50 (2%)
Adjusted rate	8.4%	9.6%	6.3%	2.4%
Terminal rate	2/31 (6%)	1/36 (3%)	1/30 (3%)	0/29 (0%)
First incidence (days)	490	479	707	649
Life table test	P=0.187N	P=0.558	P=0.511N	P=0.315N
Logistic regression test	P=0.162N	P=0.465	P=0.501N	P=0.315N
Cochran-Armitage test	P=0.162N			
Fisher exact test		P=0.500	P=0.500N	P=0.309N
All Organs: Benign Neoplasms				
Overall rate	31/50 (62%)	31/50 (62%)	33/50 (66%)	43/50 (86%)
Adjusted rate	74.9%	67.3%	84.3%	95.5%
Terminal rate	21/31 (68%)	21/36 (58%)	24/30 (80%)	27/29 (93%)
First incidence (days)	449	448	436	497
Life table test	P=0.003	P=0.289N	P=0.364	P=0.020
Logistic regression test	P=0.002	P=0.521N	P=0.378	P=0.007
Cochran-Armitage test	P=0.003			
Fisher exact test		P=0.582N	P=0.418	P=0.006

TABLE C3

Statistical Analysis of Primary Neoplasms in Male Mice in the 2-Year Inhalation Study of Nitromethane (continued)

	0 ppm	188 ppm	375 ppm	750 ppm
All Organs: Malignant Neoplasms				
Overall rate	22/50 (44%)	25/50 (50%)	24/50 (48%)	22/50 (44%)
Adjusted rate	48.3%	55.3%	51.9%	50.0%
Terminal rate	9/31 (29%)	16/36 (44%)	9/30 (30%)	9/29 (31%)
First incidence (days)	441	448	377	406
Life table test	P=0.489	P=0.559	P=0.403	P=0.556
Logistic regression test	P=0.407N	P=0.145	P=0.343	P=0.534
Cochran-Armitage test	P=0.472N			
Fisher exact test		P=0.344	P=0.421	P=0.580N
All Organs: Benign or Malignant Neoplasms				
Overall rate	40/50 (80%)	39/50 (78%)	43/50 (86%)	46/50 (92%)
Adjusted rate	83.0%	81.2%	89.5%	95.8%
Terminal rate	23/31 (74%)	27/36 (75%)	25/30 (83%)	27/29 (93%)
First incidence (days)	441	448	377	406
Life table test	P=0.057	P=0.209N	P=0.322	P=0.178
Logistic regression test	P=0.032	P=0.523N	P=0.211	P=0.070
Cochran-Armitage test	P=0.034			
Fisher exact test		P=0.500N	P=0.298	P=0.074

(T)Terminal sacrifice

- ^a Number of neoplasm-bearing animals/number of animals examined. Denominator is number of animals examined microscopically for adrenal gland, liver, lung, and pancreatic islets; for other tissues, denominator is number of animals necropsied.
- ^b Kaplan-Meier estimated neoplasm incidence at the end of the study after adjustment for intercurrent mortality
- ^c Observed incidence at terminal kill
- ^d Beneath the control incidence are the P values associated with the trend test. Beneath the exposed group incidence are the P values corresponding to pairwise comparisons between the controls and that exposed group. The life table test regards neoplasms in animals dying prior to terminal kill as being (directly or indirectly) the cause of death. The logistic regression test regards these lesions as nonfatal. The Cochran-Armitage and Fisher exact tests compare directly the overall incidence rates. For all tests, a negative trend or a lower incidence in an exposure group is indicated by N.
- ^e Not applicable; no neoplasms in animal group

TABLE C4a
Historical Incidence of Harderian Gland Neoplasms in Chamber Control Male B6C3F₁ Mice^a

Study	Incidence in Controls		
	Adenoma	Carcinoma	Adenoma or Carcinoma
Historical Incidence at Battelle Pacific Northwest Laboratories			
1,3-Butadiene	6/50	0/50	6/50
Acetonitrile	5/50	0/50	5/50
Allyl glycidyl ether	4/50	0/50	4/50
2-Chloroacetophenone	3/50	0/50	3/50
<i>l</i> -Epinephrine Hydrochloride	2/50	0/50	2/50
Chloroethane	2/50	2/50	4/50
Hexachlorocyclopentadiene	7/50	0/50	7/50
<i>o</i> -Chlorobenzalmalonitrile (CS2)	6/50	0/50	6/50
Ozone	1/50	0/50	1/50
Total	36/450 (8.0%)	2/450 (0.4%)	38/450 (8.4%)
Standard deviation	4.2%	1.3%	4.0%
Range	2%-14%	0%-4%	2%-14%
Overall Historical Incidence			
Total	47/950 (5.0%)	2/950 (0.2%)	49/950 (5.2%)
Standard deviation	4.5%	0.9%	4.5%
Range	0%-14%	0%-4%	0%-14%

^a Data as of 12 May 1995

TABLE C4b
Historical Incidence of Alveolar/bronchiolar Neoplasms in Chamber Control Male B6C3F₁ Mice^a

Study	Incidence in Controls		
	Adenoma	Carcinoma	Adenoma or Carcinoma
Historical Incidence at Battelle Pacific Northwest Laboratories			
1,3-Butadiene	18/50	5/50	21/50
Acetonitrile	6/50	4/50	10/50
Allyl glycidyl ether	7/50	0/50	7/50
2-Chloroacetophenone	7/50	6/50	11/50
<i>l</i> -Epinephrine Hydrochloride	11/50	5/50	15/50
Chloroethane	3/50	2/50	5/50
Hexachlorocyclopentadiene	11/49	0/49	11/49
<i>o</i> -Chlorobenzalmalononitrile (CS2)	7/49	7/49	14/49
Ozone	6/50	8/50	14/50
Total	76/448 (17.0%)	37/448 (8.3%)	108/448 (24.1%)
Standard deviation	8.7%	5.8%	9.5%
Range	6%-36%	0%-16%	10%-42%
Overall Historical Incidence			
Total	141/947 (14.9%)	75/947 (7.9%)	205/947 (21.7%)
Standard deviation	7.0%	5.7%	8.0%
Range	6%-36%	0%-16%	10%-42%

^a Data as of 12 May 1995

TABLE C5
Summary of the Incidence of Nonneoplastic Lesions in Male Mice in the 2-Year Inhalation Study of Nitromethane^a

	0 ppm	188 ppm	375 ppm	750 ppm
Disposition Summary				
Animals initially in study	50	50	50	50
Early deaths				
Moribund	14	11	16	16
Natural deaths	5	3	4	5
Survivors				
Terminal sacrifice	31	36	30	29
Animals examined microscopically	50	50	50	50
Alimentary System				
Gallbladder	(43)	(47)	(43)	(42)
Degeneration, hyaline	1 (2%)			
Hyperplasia		1 (2%)		
Intestine large, cecum	(46)	(48)	(47)	(46)
Hemorrhage			1 (2%)	
Intestine small, jejunum	(45)	(49)	(47)	(46)
Peyer's patch, hyperplasia			1 (2%)	
Liver	(50)	(50)	(50)	(50)
Basophilic focus		1 (2%)	3 (6%)	1 (2%)
Clear cell focus	2 (4%)	2 (4%)	2 (4%)	8 (16%)
Eosinophilic focus	11 (22%)	8 (16%)	9 (18%)	11 (22%)
Hematopoietic cell proliferation		2 (4%)		
Inflammation, chronic			2 (4%)	1 (2%)
Mixed cell focus	1 (2%)			
Necrosis	4 (8%)	3 (6%)	3 (6%)	2 (4%)
Bile duct, cyst	1 (2%)		1 (2%)	
Bile duct, degeneration	1 (2%)			
Mesentery	(3)		(6)	(2)
Fat, inflammation, chronic			1 (17%)	
Fat, necrosis	3 (100%)		3 (50%)	2 (100%)
Pancreas	(49)	(50)	(49)	(49)
Angiectasis				1 (2%)
Atrophy	2 (4%)			
Basophilic focus		1 (2%)		
Cytoplasmic alteration		1 (2%)		
Duct, cyst	1 (2%)		1 (2%)	
Stomach, forestomach	(49)	(50)	(50)	(48)
Inflammation, suppurative				1 (2%)
Epithelium, hyperplasia			4 (8%)	1 (2%)
Stomach, glandular	(48)	(48)	(48)	(48)
Inflammation		1 (2%)		
Ulcer	1 (2%)	2 (4%)		
Tooth	(3)	(3)	(1)	
Developmental malformation	2 (67%)	2 (67%)	1 (100%)	
Dysplasia		1 (33%)		
Infiltration cellular, mast cell	1 (33%)			

^a Number of animals examined microscopically at the site and the number of animals with lesion

TABLE C5

Summary of the Incidence of Nonneoplastic Lesions in Male Mice in the 2-Year Inhalation Study of Nitromethane
(continued)

	0 ppm	188 ppm	375 ppm	750 ppm
Cardiovascular System				
Heart	(50)	(50)	(50)	(50)
Cardiomyopathy	20 (40%)	20 (40%)	20 (40%)	19 (38%)
Mineralization			1 (2%)	
Artery, thrombosis			1 (2%)	
Atrium, thrombosis	1 (2%)			
Endothelium, hyperplasia			2 (4%)	
Endocrine System				
Adrenal cortex	(49)	(50)	(49)	(48)
Degeneration			1 (2%)	
Degeneration, cystic			1 (2%)	
Hematopoietic cell proliferation	1 (2%)			
Hemorrhage			1 (2%)	
Hyperplasia	4 (8%)	4 (8%)	6 (12%)	6 (13%)
Hypertrophy	22 (45%)	22 (44%)	19 (39%)	22 (46%)
Capsule, hyperplasia			2 (4%)	2 (4%)
Adrenal medulla	(49)	(50)	(49)	(47)
Hyperplasia	1 (2%)		1 (2%)	1 (2%)
Islets, pancreatic	(49)	(50)	(49)	(49)
Hyperplasia	5 (10%)	4 (8%)	3 (6%)	4 (8%)
Parathyroid gland	(41)	(34)	(38)	(37)
Cyst			1 (3%)	
Pituitary gland	(47)	(50)	(46)	(47)
Pars intermedia, hyperplasia		1 (2%)		
Thyroid gland	(50)	(50)	(49)	(48)
Follicular cell, hyperplasia	9 (18%)	3 (6%)	2 (4%)	4 (8%)
General Body System				
None				
Genital System				
Epididymis	(50)	(50)	(50)	(49)
Granuloma sperm	1 (2%)	1 (2%)		1 (2%)
Inflammation, suppurative			1 (2%)	
Penis	(1)	(2)	(3)	(1)
Inflammation, suppurative	1 (100%)	2 (100%)	1 (33%)	1 (100%)
Preputial gland	(49)	(50)	(49)	(48)
Cyst	5 (10%)	3 (6%)	2 (4%)	4 (8%)
Inflammation, chronic	4 (8%)	3 (6%)	5 (10%)	4 (8%)
Inflammation, suppurative		1 (2%)		
Bilateral, cyst			1 (2%)	
Prostate	(49)	(50)	(47)	(46)
Hyperplasia	1 (2%)			
Inflammation, suppurative		2 (4%)	1 (2%)	2 (4%)
Seminal vesicle	(49)	(49)	(49)	(47)
Hyperplasia			1 (2%)	
Inflammation	1 (2%)			
Testes	(50)	(50)	(50)	(50)
Atrophy	4 (8%)	2 (4%)	4 (8%)	4 (8%)
Inflammation, suppurative			1 (2%)	

TABLE C5

Summary of the Incidence of Nonneoplastic Lesions in Male Mice in the 2-Year Inhalation Study of Nitromethane
(continued)

	0 ppm	188 ppm	375 ppm	750 ppm
Hematopoietic System				
Bone marrow	(49)	(50)	(50)	(50)
Angiectasis				1 (2%)
Hyperplasia	1 (2%)	2 (4%)	4 (8%)	1 (2%)
Lymph node	(3)	(1)	(1)	(2)
Iliac, hyperplasia	1 (33%)			2 (100%)
Renal, hyperplasia			1 (100%)	
Lymph node, bronchial	(26)	(26)	(24)	(28)
Hyperplasia	1 (4%)	1 (4%)	1 (4%)	
Lymph node, mandibular	(40)	(39)	(37)	(43)
Hyperplasia	2 (5%)	1 (3%)	1 (3%)	4 (9%)
Lymph node, mesenteric	(47)	(46)	(47)	(49)
Angiectasis	3 (6%)	2 (4%)		
Congestion			1 (2%)	
Hyperplasia	3 (6%)	7 (15%)	2 (4%)	5 (10%)
Lymph node, mediastinal	(35)	(37)	(36)	(40)
Hyperplasia	2 (6%)	1 (3%)		1 (3%)
Spleen	(49)	(50)	(50)	(49)
Angiectasis		1 (2%)	1 (2%)	
Fibrosis		1 (2%)		
Fibrosis, focal		1 (2%)		
Hematopoietic cell proliferation	8 (16%)	9 (18%)	11 (22%)	7 (14%)
Hyperplasia, lymphoid		2 (4%)		
Thymus	(33)	(34)	(33)	(40)
Necrosis	1 (3%)	1 (3%)		1 (3%)
Integumentary System				
Skin	(49)	(49)	(49)	(48)
Inflammation, suppurative	5 (10%)	1 (2%)	2 (4%)	
Prepuce, inflammation, suppurative	6 (12%)	3 (6%)	8 (16%)	3 (6%)
Musculoskeletal System				
Bone	(50)	(50)	(50)	(50)
Hyperostosis	1 (2%)		2 (4%)	
Nervous System				
None				
Respiratory System				
Larynx	(50)	(49)	(49)	(48)
Inflammation, suppurative	1 (2%)			1 (2%)
Lung	(50)	(50)	(50)	(50)
Hemorrhage		1 (2%)	1 (2%)	
Infiltration cellular, histiocyte	7 (14%)	2 (4%)	3 (6%)	6 (12%)
Inflammation, chronic		1 (2%)		
Pigmentation, hemosiderin		1 (2%)	3 (6%)	
Thrombosis			1 (2%)	
Alveolar epithelium, hyperplasia	1 (2%)	1 (2%)	3 (6%)	1 (2%)
Mediastinum, inflammation, chronic				1 (2%)
Perivascular, inflammation, chronic	2 (4%)			

TABLE C5

Summary of the Incidence of Nonneoplastic Lesions in Male Mice in the 2-Year Inhalation Study of Nitromethane
(continued)

	0 ppm	188 ppm	375 ppm	750 ppm
Respiratory System (continued)				
Nose	(50)	(49)	(50)	(50)
Inflammation, suppurative	1 (2%)	5 (10%)	3 (6%)	1 (2%)
Nasolacrimal duct, inflammation, suppurative	2 (4%)	3 (6%)	10 (20%)	10 (20%)
Olfactory epithelium, atrophy, focal	3 (6%)	8 (16%)		
Olfactory epithelium, degeneration		10 (20%)	50 (100%)	50 (100%)
Olfactory epithelium, metaplasia		1 (2%)	41 (82%)	49 (98%)
Respiratory epithelium, degeneration, hyaline	5 (10%)	5 (10%)	50 (100%)	50 (100%)
Respiratory epithelium, metaplasia, squamous		2 (4%)		
Trachea	(49)	(49)	(49)	(49)
Metaplasia, squamous			1 (2%)	
Special Senses System				
Eye		(1)	(3)	(5)
Inflammation			3 (100%)	4 (80%)
Harderian gland	(49)	(50)	(50)	(49)
Hyperplasia	2 (4%)	2 (4%)	6 (12%)	2 (4%)
Urinary System				
Kidney	(50)	(50)	(49)	(49)
Amyloid deposition			1 (2%)	
Hydronephrosis	4 (8%)	1 (2%)	3 (6%)	
Inflammation, suppurative	1 (2%)	4 (8%)	2 (4%)	2 (4%)
Metaplasia, osseous	1 (2%)	4 (8%)	1 (2%)	1 (2%)
Nephropathy	35 (70%)	34 (68%)	33 (67%)	41 (84%)
Cortex, cyst		1 (2%)	1 (2%)	
Pelvis, necrosis				1 (2%)
Renal tubule, hyperplasia	2 (4%)	5 (10%)	2 (4%)	3 (6%)
Renal tubule, mineralization			2 (4%)	
Ureter				(1)
Inflammation, suppurative				1 (100%)
Necrosis				1 (100%)
Urethra		(1)		
Inflammation, suppurative		1 (100%)		
Urinary bladder	(48)	(50)	(49)	(48)
Calculus, gross observation	1 (2%)			
Inflammation, chronic			1 (2%)	
Inflammation, suppurative	1 (2%)	4 (8%)	2 (4%)	3 (6%)
Transitional epithelium, hyperplasia		1 (2%)		2 (4%)

APPENDIX D
SUMMARY OF LESIONS IN FEMALE MICE
IN THE 2-YEAR INHALATION STUDY
OF NITROMETHANE

TABLE D1	Summary of the Incidence of Neoplasms in Female Mice in the 2-Year Inhalation Study of Nitromethane	188
TABLE D2	Individual Animal Tumor Pathology of Female Mice in the 2-Year Inhalation Study of Nitromethane	192
TABLE D3	Statistical Analysis of Primary Neoplasms in Female Mice in the 2-Year Inhalation Study of Nitromethane	214
TABLE D4a	Historical Incidence of Harderian Gland Neoplasms in Chamber Control Female B6C3F ₁ Mice	219
TABLE D4b	Historical Incidence of Hepatocellular Neoplasms in Chamber Control Female B6C3F ₁ Mice	220
TABLE D4c	Historical Incidence of Alveolar/bronchiolar Neoplasms in Chamber Control Female B6C3F ₁ Mice	221
TABLE D5	Summary of the Incidence of Nonneoplastic Lesions in Female Mice in the 2-Year Inhalation Study of Nitromethane	222

TABLE D1
Summary of the Incidence of Neoplasms in Female Mice in the 2-Year Inhalation Study of Nitromethane^a

	0 ppm	188 ppm	375 ppm	750 ppm
Disposition Summary				
Animals initially in study	50	50	50	50
Early deaths				
Accidental deaths	2		1	
Moribund	16	17	20	12
Natural deaths	7	5	3	2
Survivors				
Died last week of study		1		
Terminal sacrifice	25	27	26	36
Animals examined microscopically	50	50	50	50
Alimentary System				
Gallbladder	(40)	(45)	(45)	(46)
Intestine large, colon	(49)	(48)	(47)	(50)
Leiomyoma			1 (2%)	
Intestine large, cecum	(49)	(46)	(47)	(50)
Intestine small, duodenum	(48)	(43)	(45)	(49)
Intestine small, jejunum	(47)	(45)	(47)	(48)
Intestine small, ileum	(47)	(46)	(46)	(49)
Liver	(50)	(49)	(49)	(50)
Hemangiosarcoma	2 (4%)		2 (4%)	
Hepatocellular carcinoma	7 (14%)	14 (29%)	8 (16%)	11 (22%)
Hepatocellular carcinoma, multiple	3 (6%)			1 (2%)
Hepatocellular adenoma	11 (22%)	12 (24%)	13 (27%)	22 (44%)
Hepatocellular adenoma, multiple	3 (6%)	13 (27%)	4 (8%)	13 (26%)
Hepatocholangiocarcinoma	1 (2%)			
Histiocytic sarcoma	1 (2%)		2 (4%)	
Mesentery	(7)	(14)	(8)	(11)
Hemangioma		1 (7%)		1 (9%)
Hemangiosarcoma			1 (13%)	
Hepatocellular carcinoma, metastatic, liver		1 (7%)		
Sarcoma		1 (7%)		
Sarcoma, metastatic, skin	1 (14%)			
Oral mucosa	(1)			(1)
Hepatocholangiocarcinoma, metastatic, liver	1 (100%)			
Pancreas	(50)	(48)	(48)	(50)
Histiocytic sarcoma			1 (2%)	
Salivary glands	(49)	(48)	(49)	(50)
Hemangiosarcoma		1 (2%)		
Stomach, forestomach	(50)	(48)	(49)	(50)
Squamous cell papilloma	1 (2%)	1 (2%)		2 (4%)
Stomach, glandular	(49)	(48)	(48)	(50)
Adenoma		1 (2%)		
Cardiovascular System				
Heart	(50)	(50)	(50)	(50)
Hepatocellular carcinoma, metastatic, liver		1 (2%)		
Hepatocholangiocarcinoma, metastatic, liver	1 (2%)			
Histiocytic sarcoma	1 (2%)		1 (2%)	
Pericardium, hepatocellular carcinoma, metastatic, liver		1 (2%)		

TABLE D1

Summary of the Incidence of Neoplasms in Female Mice in the 2-Year Inhalation Study of Nitromethane (continued)

	0 ppm	188 ppm	375 ppm	750 ppm
Endocrine System				
Adrenal cortex	(50)	(48)	(49)	(50)
Capsule, adenoma	1 (2%)		1 (2%)	1 (2%)
Adrenal medulla	(50)	(48)	(49)	(49)
Pheochromocytoma benign			1 (2%)	
Bilateral, pheochromocytoma benign			1 (2%)	
Islets, pancreatic	(50)	(48)	(47)	(50)
Adenoma				1 (2%)
Parathyroid gland	(33)	(34)	(33)	(34)
Carcinoma	1 (3%)			
Pituitary gland	(50)	(46)	(48)	(50)
Pars distalis, adenoma	9 (18%)	10 (22%)	8 (17%)	4 (8%)
Pars intermedia, adenoma		1 (2%)		
Thyroid gland	(50)	(48)	(48)	(50)
Follicular cell, adenoma	4 (8%)	1 (2%)	1 (2%)	1 (2%)
General Body System				
None				
Genital System				
Ovary	(47)	(47)	(48)	(48)
Cystadenocarcinoma				1 (2%)
Cystadenoma	2 (4%)	1 (2%)		3 (6%)
Granulosa cell tumor benign		2 (4%)		
Histiocytic sarcoma	1 (2%)			
Luteoma				1 (2%)
Teratoma benign				1 (2%)
Uterus	(50)	(49)	(49)	(50)
Adenoma	1 (2%)	1 (2%)		1 (2%)
Deciduoma benign		1 (2%)		
Hemangioma	2 (4%)	5 (10%)		
Histiocytic sarcoma	1 (2%)		1 (2%)	
Polyp stromal	4 (8%)	2 (4%)	1 (2%)	3 (6%)
Vagina	(1)			
Histiocytic sarcoma	1 (100%)			
Hematopoietic System				
Bone marrow	(50)	(48)	(49)	(50)
Hemangiosarcoma	1 (2%)		2 (4%)	
Histiocytic sarcoma	1 (2%)			
Mast cell tumor malignant	1 (2%)			
Sarcoma, metastatic, skin				1 (2%)
Lymph node	(8)	(6)	(5)	(6)
Lymph node, bronchial	(39)	(36)	(40)	(40)
Hepatocellular carcinoma, metastatic, liver		2 (6%)		
Hepatocholangiocarcinoma, metastatic, liver	1 (3%)			
Lymph node, mandibular	(43)	(34)	(38)	(43)
Histiocytic sarcoma	1 (2%)		1 (3%)	
Lymph node, mesenteric	(48)	(46)	(46)	(48)
Histiocytic sarcoma	1 (2%)		1 (2%)	

TABLE D1
Summary of the Incidence of Neoplasms in Female Mice in the 2-Year Inhalation Study of Nitromethane (continued)

	0 ppm	188 ppm	375 ppm	750 ppm
Hematopoietic System (continued)				
Lymph node, mediastinal	(38)	(37)	(35)	(41)
Carcinoma, metastatic, harderian gland			1 (3%)	
Hepatocellular carcinoma, metastatic, liver		1 (3%)		
Hepatocholangiocarcinoma, metastatic, liver	1 (3%)			
Histiocytic sarcoma			1 (3%)	
Spleen	(50)	(48)	(49)	(50)
Hemangiosarcoma		1 (2%)	1 (2%)	
Histiocytic sarcoma			2 (4%)	
Mast cell tumor malignant	1 (2%)			
Thymus	(43)	(39)	(41)	(47)
Hepatocellular carcinoma, metastatic, liver		1 (3%)		
Hepatocholangiocarcinoma, metastatic, liver	1 (2%)			
Mast cell tumor malignant	1 (2%)			
Thymoma benign	1 (2%)			
Integumentary System				
Mammary gland	(50)	(48)	(49)	(50)
Adenoma			1 (2%)	
Carcinoma	2 (4%)	2 (4%)	2 (4%)	
Skin	(49)	(47)	(50)	(50)
Squamous cell carcinoma			1 (2%)	
Subcutaneous tissue, hemangiosarcoma			2 (4%)	
Subcutaneous tissue, sarcoma	1 (2%)	1 (2%)	1 (2%)	2 (4%)
Musculoskeletal System				
Bone	(50)	(50)	(50)	(50)
Hemangiosarcoma		1 (2%)	2 (4%)	
Osteosarcoma			1 (2%)	
Nervous System				
Brain	(50)	(50)	(49)	(50)
Respiratory System				
Larynx	(49)	(48)	(49)	(50)
Lung	(50)	(50)	(49)	(50)
Alveolar/bronchiolar adenoma	3 (6%)	2 (4%)	2 (4%)	8 (16%)
Alveolar/bronchiolar adenoma, multiple		1 (2%)		1 (2%)
Alveolar/bronchiolar carcinoma		3 (6%)	5 (10%)	
Alveolar/bronchiolar carcinoma, multiple				3 (6%)
Carcinoma, metastatic, harderian gland			2 (4%)	
Hepatocellular carcinoma, metastatic, liver	2 (4%)	5 (10%)		3 (6%)
Hepatocholangiocarcinoma, metastatic, liver	1 (2%)			
Histiocytic sarcoma	1 (2%)		2 (4%)	
Osteosarcoma, metastatic, bone			1 (2%)	
Sarcoma, metastatic, skin				1 (2%)

TABLE D1
Summary of the Incidence of Neoplasms in Female Mice in the 2-Year Inhalation Study of Nitromethane (continued)

	0 ppm	188 ppm	375 ppm	750 ppm
Respiratory System (continued)				
Lung (continued)	(50)	(50)	(49)	(50)
Mediastinum, hemangioma	1 (2%)			
Mediastinum, hemangiosarcoma	1 (2%)			
Mediastinum, hepatocellular carcinoma, metastatic, liver		2 (4%)		
Mediastinum, hepatocholangiocarcinoma, metastatic, liver	1 (2%)			
Mediastinum, mast cell tumor malignant	1 (2%)			
Nose	(50)	(49)	(50)	(50)
Special Senses System				
Harderian gland	(49)	(49)	(50)	(50)
Adenoma	4 (8%)	6 (12%)	15 (30%)	16 (32%)
Adenoma, multiple	1 (2%)	1 (2%)	1 (2%)	3 (6%)
Carcinoma	1 (2%)	2 (4%)	4 (8%)	2 (4%)
Carcinoma, multiple				1 (2%)
Urinary System				
Kidney	(50)	(48)	(49)	(50)
Hepatocholangiocarcinoma, metastatic, liver	1 (2%)			
Histiocytic sarcoma			2 (4%)	
Osteosarcoma, metastatic, bone			1 (2%)	
Urinary bladder	(49)	(47)	(47)	(49)
Histiocytic sarcoma			1 (2%)	
Systemic Lesions				
Multiple organs ^b	(50)	(50)	(50)	(50)
Histiocytic sarcoma	2 (4%)		3 (6%)	
Lymphoma malignant	9 (18%)	7 (14%)	7 (14%)	7 (14%)
Neoplasm Summary				
Total animals with primary neoplasms ^c	38	45	43	46
Total primary neoplasms	83	95	92	110
Total animals with benign neoplasms	31	39	33	43
Total benign neoplasms	48	62	50	82
Total animals with malignant neoplasms	26	24	28	21
Total malignant neoplasms	35	33	42	28
Total animals with metastatic neoplasms	4	5	3	4
Total metastatic neoplasms	11	14	5	5

^a Number of animals examined microscopically at the site and the number of animals with neoplasm

^b Number of animals with any tissue examined microscopically

^c Primary neoplasms: all neoplasms except metastatic neoplasms

TABLE D2
Individual Animal Tumor Pathology of Female Mice in the 2-Year Inhalation Study of Nitromethane: 0 ppm

Number of Days on Study	3	3	3	4	4	4	5	5	5	6	6	6	6	6	6	6	6	6	6	6	6	7	7	7		
	0	7	8	0	3	3	7	7	9	0	1	1	3	3	5	6	6	6	8	9	9	9	0	0	1	
	1	6	5	1	6	6	4	6	7	9	7	8	2	2	7	3	7	7	1	3	3	3	7	7	6	
Carcass ID Number	1	1	1	1	1	1	1	1	1	1	1	1	1	1	1	1	1	1	1	1	1	1	1	1	1	
	1	0	3	1	3	3	0	3	1	2	3	3	1	5	2	0	0	3	4	1	4	4	1	4	3	
	1	7	1	6	7	8	1	0	3	2	2	6	0	0	8	4	5	3	6	4	1	8	2	2	5	
Alimentary System																										
Esophagus	+	+	+	+	+	+	+	+	+	+	+	+	+	+	+	+	+	+	+	+	+	+	+	+	M	
Gallbladder	A	+	+	+	I	+	A	+	+	+	A	+	+	+	+	+	+	+	+	M	+	+	A	M	+	
Intestine large, colon	+	+	+	+	+	+	+	+	+	+	+	+	M	+	+	+	+	+	+	+	+	+	+	+	+	
Intestine large, rectum	+	+	+	+	+	+	+	+	+	+	+	+	+	+	+	+	+	+	+	+	+	+	+	+	+	
Intestine large, cecum	+	+	+	+	+	+	+	+	+	+	A	+	+	+	+	+	+	+	+	+	+	+	+	+	+	
Intestine small, duodenum	+	+	+	+	+	A	+	+	+	+	+	+	+	+	+	+	+	+	+	+	+	+	A	+	+	
Intestine small, jejunum	+	+	+	+	+	A	+	+	+	+	+	+	+	+	+	+	+	+	+	+	+	+	A	+	+	
Intestine small, ileum	+	+	+	+	+	A	+	+	+	A	+	+	+	+	+	+	+	+	+	+	+	+	+	+	+	
Liver	+	+	+	+	+	+	+	+	+	+	+	+	+	+	+	+	+	+	+	+	+	+	+	+	+	
Hemangiosarcoma																									X	
Hepatocellular carcinoma														X						X	X	X				
Hepatocellular carcinoma, multiple							X																X	X		
Hepatocellular adenoma								X												X			X	X		
Hepatocellular adenoma, multiple																X										
Hepatocholangiocarcinoma											X															
Histiocytic sarcoma																						X				
Mesentery							+							+					+				+			
Sarcoma, metastatic, skin																							X			
Oral mucosa												+														
Hepatocholangiocarcinoma, metastatic, liver												X														
Pancreas	+	+	+	+	+	+	+	+	+	+	+	+	+	+	+	+	+	+	+	+	+	+	+	+	+	
Salivary glands	+	+	+	+	+	+	+	+	+	+	+	+	+	+	+	+	+	+	+	+	+	+	M	+	+	
Stomach, forestomach	+	+	+	+	+	+	+	+	+	+	+	+	+	+	+	+	+	+	+	+	+	+	+	+	+	
Squamous cell papilloma																										
Stomach, glandular	+	+	+	+	+	+	A	+	+	+	+	+	+	+	+	+	+	+	+	+	+	+	+	+	+	
Cardiovascular System																										
Heart	+	+	+	+	+	+	+	+	+	+	+	+	+	+	+	+	+	+	+	+	+	+	+	+	+	
Hepatocholangiocarcinoma, metastatic, liver														X												
Histiocytic sarcoma																							X			
Endocrine System																										
Adrenal cortex	+	+	+	+	+	+	+	+	+	+	+	+	+	+	+	+	+	+	+	+	+	+	+	+	+	
Capsule, adenoma																										
Adrenal medulla	+	+	+	+	+	+	+	+	+	+	+	+	+	+	+	+	+	+	+	+	+	+	+	+	+	
Islets, pancreatic	+	+	+	+	+	+	+	+	+	+	+	+	+	+	+	+	+	+	+	+	+	+	+	+	+	
Parathyroid gland	+	+	M	+	+	M	+	+	+	+	M	+	+	+	+	+	+	+	+	+	+	+	+	+	I	
Carcinoma																										
Pituitary gland	+	+	+	+	+	+	+	+	+	+	+	+	+	+	+	+	+	+	+	+	+	+	+	+	+	
Pars distalis, adenoma													X				X			X						
Thyroid gland	+	+	+	+	+	+	+	+	+	+	+	+	+	+	+	+	+	+	+	+	+	+	+	+	+	
Follicular cell, adenoma				X								X														
General Body System																										
None																										

+: Tissue examined microscopically
 A: Autolysis precludes examination

M: Missing tissue
 I: Insufficient tissue

X: Lesion present
 Blank: Not examined

TABLE D2
Individual Animal Tumor Pathology of Female Mice in the 2-Year Inhalation Study of Nitromethane: 0 ppm (continued)

Number of Days on Study	3	3	3	4	4	4	5	5	5	6	6	6	6	6	6	6	6	6	6	6	6	6	7	7	7		
	0	7	8	0	3	3	7	7	9	0	1	1	3	3	5	6	6	6	8	9	9	9	0	0	1		
	1	6	5	1	6	6	4	6	7	9	7	8	2	2	7	3	7	7	1	3	3	3	7	7	6		
Carcass ID Number	1	1	1	1	1	1	1	1	1	1	1	1	1	1	1	1	1	1	1	1	1	1	1	1	1		
	1	0	3	1	3	3	0	3	1	2	3	3	1	5	2	0	0	3	4	1	4	4	1	4	3		
	1	7	1	6	7	8	1	0	3	2	2	6	0	0	8	4	5	3	6	4	1	8	2	2	5		
Respiratory System																											
Larynx	+	+	+	+	I	+	+	+	+	+	+	+	+	+	+	+	+	+	+	+	+	+	+	+	+	+	
Lung	+	+	+	+	+	+	+	+	+	+	+	+	+	+	+	+	+	+	+	+	+	+	+	+	+	+	
Alveolar/bronchiolar adenoma																										X	
Hepatocellular carcinoma, metastatic, liver										X																X	
Hepatocholangiocarcinoma, metastatic, liver												X															
Histiocytic sarcoma																										X	
Mediastinum, hemangioma																											
Mediastinum, hemangiosarcoma																											
Mediastinum, hepatocholangiocarcinoma, metastatic, liver												X															
Mediastinum, mast cell tumor malignant																										X	
Nose	+	+	+	+	+	+	+	+	+	+	+	+	+	+	+	+	+	+	+	+	+	+	+	+	+	+	
Trachea	+	+	+	+	+	+	+	+	+	+	+	+	+	+	+	+	+	+	+	+	+	+	+	+	+	+	
Special Senses System																											
Harderian gland	+	+	+	+	+	+	+	+	+	+	+	+	+	+	+	+	+	+	+	+	+	+	+	+	+	+	
Adenoma																											
Adenoma, multiple																											
Carcinoma																											
Urinary System																											
Kidney	+	+	+	+	+	+	+	+	+	+	+	+	+	+	+	+	+	+	+	+	+	+	+	+	+	+	
Hepatocholangiocarcinoma, metastatic, liver																											
Urinary bladder	+	+	+	+	+	+	+	+	+	+	+	+	+	+	+	+	+	+	+	+	+	+	+	+	+	+	
Systemic Lesions																											
Multiple organs	+	+	+	+	+	+	+	+	+	+	+	+	+	+	+	+	+	+	+	+	+	+	+	+	+	+	
Histiocytic sarcoma																										X	
Lymphoma malignant				X	X					X	X	X							X							X	

TABLE D2
Individual Animal Tumor Pathology of Female Mice in the 2-Year Inhalation Study of Nitromethane: 188 ppm
 (continued)

Number of Days on Study	3 3 4 4 4 5 5 5 5 5 5 5 6 6 6 6 6 6 6 6 6 6 7 7 7 7
	4 5 1 2 4 3 5 6 6 6 7 8 3 3 4 5 5 6 6 9 9 3 3 3 3
	5 7 6 6 1 4 5 4 9 9 9 1 7 9 6 3 6 3 5 3 3 1 4 4 4
Carcass ID Number	3 3
	1 3 3 0 4 1 0 1 1 3 2 2 0 1 4 4 3 1 2 1 3 1 2 2 3
	4 0 8 7 1 6 8 1 2 1 9 4 4 3 5 9 5 0 7 5 3 7 0 2 7
Respiratory System	
Larynx	+ + + + + + + + + + A + A + + + + + + + + + + + +
Lung	+ +
Alveolar/bronchiolar adenoma	
Alveolar/bronchiolar adenoma, multiple	
Alveolar/bronchiolar carcinoma	X
Hepatocellular carcinoma, metastatic, liver	X X X
Mediastinum, hepatocellular carcinoma, metastatic, liver	X
Nose	+ + + + + + + + + + + + A + + + + + + + + + + + +
Trachea	+ + + + + + + + + + + A + A + + + + + + + + + + + +
Special Senses System	
Eye	
Harderian gland	+ +
Adenoma	
Adenoma, multiple	X X
Carcinoma	X
Urinary System	
Kidney	+ + + + + + + + + + + A + A + + + + + + + + + + + +
Urinary bladder	+ + + + + + + + + + + A + A + + + + + + + + + + + +
Systemic Lesions	
Multiple organs	+ +
Lymphoma malignant	X

TABLE D2
Individual Animal Tumor Pathology of Female Mice in the 2-Year Inhalation Study of Nitromethane: 188 ppm
 (continued)

Number of Days on Study	7 7																									
	3 3																									
	4 5 5 5 5 5 5 5 5 5 5 6 6 6 6 6 6 6 6 7 7 7 7 7 7 7																									
Carcass ID Number	3 3																									Total
	4 0 0 2 2 3 3 4 4 4 5 0 0 0 1 1 2 4 4 0 2 2 3 3 4																									Tissues/
	7 1 3 1 5 2 4 0 3 6 0 2 5 6 8 9 6 2 4 9 3 8 6 9 8																									Tumors
Respiratory System																										
Larynx	+ +																									48
Lung	+ +																									50
Alveolar/bronchiolar adenoma																										2
Alveolar/bronchiolar adenoma, multiple	X																									1
Alveolar/bronchiolar carcinoma	X																									3
Hepatocellular carcinoma, metastatic, liver																										5
Mediastinum, hepatocellular carcinoma, metastatic, liver																										2
Nose	+ +																									49
Trachea	+ +																									48
Special Senses System																										
Eye																										1
Harderian gland	+ +																									49
Adenoma	X																									6
Adenoma, multiple	X																									1
Carcinoma	X																									2
Urinary System																										
Kidney	+ +																									48
Urinary bladder	+ + + + + + I +																									47
Systemic Lesions																										
Multiple organs	+ +																									50
Lymphoma malignant	X																									7

TABLE D2-
Individual Animal Tumor Pathology of Female Mice in the 2-Year Inhalation Study of Nitromethane: 375 ppm
 (continued)

Number of Days on Study	0	2	4	5	5	5	6	6	6	6	6	6	6	6	6	6	6	6	6	7	7	7	7	7			
	6	9	9	4	6	7	0	0	0	3	3	3	4	5	6	6	7	8	9	9	1	2	2	3	3		
	9	6	8	8	8	2	2	8	9	1	7	7	6	3	5	5	9	0	3	3	6	1	7	3	4		
Carcass ID Number	5	5	5	5	5	5	5	5	5	5	5	5	5	5	5	5	5	5	5	5	5	5	5	5	5		
	0	4	1	1	1	3	1	2	2	2	1	4	4	0	0	1	4	3	0	3	2	3	0	3	0		
	7	0	6	0	7	1	2	9	4	6	1	9	7	6	3	8	5	2	1	8	2	3	5	7	4		
Special Senses System																											
Eye						+																					
Harderian gland	+	+	+	+	+	+	+	+	+	+	+	+	+	+	+	+	+	+	+	+	+	+	+	+	+	+	
Adenoma			X				X	X		X		X	X				X	X							X		
Adenoma, multiple																											
Carcinoma																										X	
Urinary System																											
Kidney	+	+	+	+	+	A	+	+	+	+	+	+	+	+	+	+	+	+	+	+	+	+	+	+	+	+	
Histiocytic sarcoma												X														X	
Osteosarcoma, metastatic, bone																			X								
Urinary bladder	+	+	+	+	+	A	+	A	+	+	+	+	+	+	+	+	+	+	+	+	+	+	+	+	+	+	
Histiocytic sarcoma																										X	
Systemic Lesions																											
Multiple organs	+	+	+	+	+	+	+	+	+	+	+	+	+	+	+	+	+	+	+	+	+	+	+	+	+	+	
Histiocytic sarcoma												X														X	
Lymphoma malignant									X					X		X								X			

TABLE D2
Individual Animal Tumor Pathology of Female Mice in the 2-Year Inhalation Study of Nitromethane: 375 ppm
 (continued)

Number of Days on Study	7 7	
	3 3	
	4 4 4 4 4 4 4 5 5 5 5 5 6 6 6 7 7 7 7 7 7 7 7 7	
Carcass ID Number	5 5	Total Tissues/ Tumors
	0 0 1 1 2 3 4 0 1 2 2 3 3 4 4 1 2 2 2 3 3 4 4 4 5	
	8 9 4 9 7 9 2 2 3 0 1 4 6 1 3 5 3 5 8 0 5 4 6 8 0	
Special Senses System		
Eye		1
Harderian gland		50
Adenoma	+ +	15
Adenoma, multiple	X X X X X X	1
Carcinoma	X X X	4
Urinary System		
Kidney		49
Histiocytic sarcoma	+ +	2
Osteosarcoma, metastatic, bone		1
Urinary bladder		47
Histiocytic sarcoma	+ +	1
Systemic Lesions		
Multiple organs	+ +	50
Histiocytic sarcoma		3
Lymphoma malignant	X X X	7

**TABLE D2
Individual Animal Tumor Pathology of Female Mice in the 2-Year Inhalation Study of Nitromethane: 750 ppm**

Number of Days on Study	0	4	5	5	6	6	6	6	6	6	7	7	7	7	7	7	7	7	7	7	7	7	7			
	5	2	0	5	0	3	3	5	8	9	0	1	2	2	3	3	3	3	3	3	3	3	3	3		
	1	6	3	3	3	2	8	7	7	9	6	6	1	9	4	4	4	4	4	4	4	4	4	5		
Carcass ID Number	7	7	7	7	7	7	7	7	7	7	7	7	7	7	7	7	7	7	7	7	7	7	7	7		
	3	1	4	2	3	3	0	2	0	2	0	0	1	3	0	1	1	1	1	2	2	3	4	0		
	3	9	4	4	1	8	9	9	4	8	3	1	5	5	8	4	6	8	1	3	4	2	5	5		
Alimentary System																										
Esophagus	+	+	+	+	M	+	+	+	+	+	+	+	+	+	+	+	+	+	+	+	+	+	+	+		
Gallbladder	A	+	+	+	+	I	+	+	+	+	+	M	+	+	+	M	+	+	+	+	+	+	+	+		
Intestine large, colon	+	+	+	+	+	+	+	+	+	+	+	+	+	+	+	+	+	+	+	+	+	+	+	+		
Intestine large, rectum	A	+	+	+	+	+	+	+	+	+	+	+	+	+	+	+	+	+	+	+	+	+	+	+		
Intestine large, cecum	+	+	+	+	+	+	+	+	+	+	+	+	+	+	+	+	+	+	+	+	+	+	+	+		
Intestine small, duodenum	A	+	+	+	+	+	+	+	+	+	+	+	+	+	+	+	+	+	+	+	+	+	+	+		
Intestine small, jejunum	A	+	+	A	+	+	+	+	+	+	+	+	+	+	+	+	+	+	+	+	+	+	+	+		
Intestine small, ileum	A	+	+	+	+	+	+	+	+	+	+	+	+	+	+	+	+	+	+	+	+	+	+	+		
Liver	+	+	+	+	+	+	+	+	+	+	+	+	+	+	+	+	+	+	+	+	+	+	+	+		
Hepatocellular carcinoma	X	X			X	X	X		X	X		X	X													
Hepatocellular carcinoma, multiple													X													
Hepatocellular adenoma		X	X						X	X		X			X	X	X							X		
Hepatocellular adenoma, multiple					X								X							X	X	X	X			
Mesentery						+			+				+		+						+			+		
Hemangioma										X																
Oral mucosa																										
Pancreas	+	+	+	+	+	+	+	+	+	+	+	+	+	+	+	+	+	+	+	+	+	+	+	+		
Salivary glands	+	+	+	+	+	+	+	+	+	+	+	+	+	+	+	+	+	+	+	+	+	+	+	+		
Stomach, forestomach	+	+	+	+	+	+	+	+	+	+	+	+	+	+	+	+	+	+	+	+	+	+	+	+		
Squamous cell papilloma																										
Stomach, glandular	+	+	+	+	+	+	+	+	+	+	+	+	+	+	+	+	+	+	+	+	+	+	+	+		
Cardiovascular System																										
Heart	+	+	+	+	+	+	+	+	+	+	+	+	+	+	+	+	+	+	+	+	+	+	+	+		
Endocrine System																										
Adrenal cortex	+	+	+	+	+	+	+	+	+	+	+	+	+	+	+	+	+	+	+	+	+	+	+	+		
Capsule, adenoma																										
Adrenal medulla	+	+	+	+	+	+	+	+	+	+	+	+	+	+	+	I	+	+	+	+	+	+	+	+		
Islets, pancreatic	+	+	+	+	+	+	+	+	+	+	+	+	+	+	+	+	+	+	+	+	+	+	+	+		
Adenoma						X																				
Parathyroid gland	+	+	+	M	+	+	M	+	+	+	+	M	+	+	+	M	+	+	+	M	M	+	M	+		
Pituitary gland	+	+	+	+	+	+	+	+	+	+	+	+	+	+	+	+	+	+	+	+	+	+	+	+		
Pars distalis, adenoma																X										
Thyroid gland	+	+	+	+	+	+	+	+	+	+	+	+	+	+	+	+	+	+	+	+	+	+	+	+		
Follicular cell, adenoma																										
General Body System																										
None																										
Genital System																										
Clitoral gland	+	M	+	+	+	+	+	+	+	+	M	+	+	+	+	M	I	+	+	+	+	M	M	M	I	+
Ovary	+	+	+	+	+	+	+	+	+	+	+	+	+	+	+	+	+	+	+	+	+	+	+	+	+	
Cystadenocarcinoma											X															
Cystadenoma											X									X	X					
Luteoma						X																				
Teratoma benign	X																									
Uterus	+	+	+	+	+	+	+	+	+	+	+	+	+	+	+	+	+	+	+	+	+	+	+	+	+	
Adenoma																										
Polyp stromal												X										X				

TABLE D2

Individual Animal Tumor Pathology of Female Mice in the 2-Year Inhalation Study of Nitromethane: 750 ppm
(continued)

Number of Days on Study	7 7	
	3 3	
	5 5 5 5 6 6 6 6 6 6 6 6 6 6 6 6 7 7 7 7 7 7 7 7 7	
Carcass ID Number	7 7	Total Tissues/ Tumors
	1 4 4 4 0 0 1 1 2 2 2 3 3 3 4 5 0 1 2 2 3 3 4 4 4	
	7 0 3 6 6 7 0 1 0 6 7 0 2 9 7 0 2 3 2 5 6 7 1 8 9	
Alimentary System		
Esophagus	+ +	49
Gallbladder	+ +	46
Intestine large, colon	+ +	50
Intestine large, rectum	+ +	49
Intestine large, cecum	+ +	50
Intestine small, duodenum	+ +	49
Intestine small, jejunum	+ +	48
Intestine small, ileum	+ +	49
Liver	+ +	50
Hepatocellular carcinoma		11
Hepatocellular carcinoma, multiple		1
Hepatocellular adenoma		22
Hepatocellular adenoma, multiple		13
Mesentery		11
Hemangioma		1
Oral mucosa		1
Pancreas	+ +	50
Salivary glands	+ +	50
Stomach, forestomach	+ +	50
Squamous cell papilloma		2
Stomach, glandular	+ +	50
Cardiovascular System		
Heart	+ +	50
Endocrine System		
Adrenal cortex	+ +	50
Capsule, adenoma		1
Adrenal medulla	+ +	49
Islets, pancreatic	+ +	50
Adenoma		1
Parathyroid gland	+ I M + + M + M + + + + M M + + + + + M + M M +	34
Pituitary gland	+ +	50
Pars distalis, adenoma		4
Thyroid gland	+ +	50
Follicular cell, adenoma		1
General Body System		
None		
Genital System		
Clitoral gland	I + + M + + + + + + + + + M + M M + + + + M + + +	36
Ovary	+ + + + + + + + + + + M + + + + + + M + + + + + +	48
Cystadenocarcinoma		1
Cystadenoma		3
Luteoma		1
Teratoma benign		1
Uterus	+ +	50
Adenoma		1
Polyp stromal	X	3

TABLE D2
Individual Animal Tumor Pathology of Female Mice in the 2-Year Inhalation Study of Nitromethane: 750 ppm
 (continued)

Number of Days on Study	0 4 5 5 6 6 6 6 6 6 7 7 7 7 7 7 7 7 7 7 7 7 7 7
	5 2 0 5 0 3 3 5 8 9 0 1 2 2 3 3 3 3 3 3 3 3 3 3 3 3
	1 6 3 3 3 2 8 7 7 9 6 6 1 9 4 4 4 4 4 4 4 4 4 4 5 5
Carcass ID Number	7 7
	3 1 4 2 3 3 0 2 0 2 0 0 1 3 0 1 1 1 2 2 3 4 4 0 1
	3 9 4 4 1 8 9 9 4 8 3 1 5 5 8 4 6 8 1 3 4 2 5 5 2
Hematopoietic System	
Bone marrow	+ +
Sarcoma, metastatic, skin	
Lymph node	
Lymph node, bronchial	M + + + M + + + + M + + M + + + + + M M + M M M + + +
Lymph node, mandibular	+ + + + + M M + + + + + + + + + + + + + M + + + + +
Lymph node, mesenteric	M +
Lymph node, mediastinal	+ + M M + + M + + + + + + + + + + + + + M + M + + + +
Spleen	+ +
Thymus	M + M + M + + +
Integumentary System	
Mammary gland	+ +
Skin	+ +
Subcutaneous tissue, sarcoma	
Musculoskeletal System	
Bone	+ +
Nervous System	
Brain	+ +
Respiratory System	
Larynx	+ +
Lung	+ +
Alveolar/bronchiolar adenoma	
Alveolar/bronchiolar adenoma, multiple	X
Alveolar/bronchiolar carcinoma, multiple	
Hepatocellular carcinoma, metastatic, liver	
Sarcoma, metastatic, skin	
Nose	+ +
Trachea	+ +
Special Senses System	
Harderian gland	+ +
Adenoma	
Adenoma, multiple	X
Carcinoma	
Carcinoma, multiple	
Urinary System	
Kidney	+ +
Urinary bladder	A +
Systemic Lesions	
Multiple organs	+ +
Lymphoma malignant	

TABLE D2

Individual Animal Tumor Pathology of Female Mice in the 2-Year Inhalation Study of Nitromethane: 750 ppm (continued)

Number of Days on Study	7	7	7	7	7	7	7	7	7	7	7	7	7	7	7	7	7	7	7	7	7	7	7	7	Total		
	3	3	3	3	3	3	3	3	3	3	3	3	3	3	3	3	3	3	3	3	3	3	3	3	50		
	5	5	5	5	6	6	6	6	6	6	6	6	6	6	6	6	7	7	7	7	7	7	7	7	50		
Carcass ID Number	7	7	7	7	7	7	7	7	7	7	7	7	7	7	7	7	7	7	7	7	7	7	7	7	Tissues/Tumors		
	1	4	4	4	0	0	1	1	2	2	2	3	3	3	4	5	0	1	2	2	3	3	4	4	4		
	7	0	3	6	6	7	0	1	0	6	7	0	2	9	7	0	2	3	2	5	6	7	1	8	9		
Hematopoietic System																											
Bone marrow	+	+	+	+	+	+	+	+	+	+	+	+	+	+	+	+	+	+	+	+	+	+	+	+	+	+	50
Sarcoma, metastatic, skin																											1
Lymph node							+									+	+										6
Lymph node, bronchial	+	+	+	+	+	+	+	+	+	+	+	+	+	M	+	+	+	+	+	+	+	+	+	+	+	+	40
Lymph node, mandibular	+	+	+	+	+	+	+	+	M	+	+	+	+	+	+	+	+	+	+	+	M	+	+	+	+	M	43
Lymph node, mesenteric	+	+	+	+	+	+	+	+	+	+	+	+	+	I	+	+	+	+	+	+	+	+	+	+	+	+	48
Lymph node, mediastinal	M	+	+	+	+	M	+	+	+	+	+	+	+	+	+	+	+	+	+	+	+	+	M	+	M	+	41
Spleen	+	+	+	+	+	+	+	+	+	+	+	+	+	+	+	+	+	+	+	+	+	+	+	+	+	+	50
Thymus	+	+	+	+	+	+	+	+	+	+	+	+	+	+	+	+	+	+	+	+	+	+	+	+	+	+	47
Integumentary System																											
Mammary gland	+	+	+	+	+	+	+	+	+	+	+	+	+	+	+	+	+	+	+	+	+	+	+	+	+	+	50
Skin	+	+	+	+	+	+	+	+	+	+	+	+	+	+	+	+	+	+	+	+	+	+	+	+	+	+	50
Subcutaneous tissue, sarcoma																											2
Musculoskeletal System																											
Bone	+	+	+	+	+	+	+	+	+	+	+	+	+	+	+	+	+	+	+	+	+	+	+	+	+	+	50
Nervous System																											
Brain	+	+	+	+	+	+	+	+	+	+	+	+	+	+	+	+	+	+	+	+	+	+	+	+	+	+	50
Respiratory System																											
Larynx	+	+	+	+	+	+	+	+	+	+	+	+	+	+	+	+	+	+	+	+	+	+	+	+	+	+	50
Lung	+	+	+	+	+	+	+	+	+	+	+	+	+	+	+	+	+	+	+	+	+	+	+	+	+	+	50
Alveolar/bronchiolar adenoma											X	X	X	X		X		X									8
Alveolar/bronchiolar adenoma, multiple																											1
Alveolar/bronchiolar carcinoma, multiple								X																			3
Hepatocellular carcinoma, metastatic, liver																											3
Sarcoma, metastatic, skin																											1
Nose	+	+	+	+	+	+	+	+	+	+	+	+	+	+	+	+	+	+	+	+	+	+	+	+	+	+	50
Trachea	+	+	+	+	+	+	+	+	+	+	+	+	+	+	+	+	+	+	+	+	+	+	+	+	+	+	50
Special Senses System																											
Harderian gland	+	+	+	+	+	+	+	+	+	+	+	+	+	+	+	+	+	+	+	+	+	+	+	+	+	+	50
Adenoma	X			X			X	X						X				X	X	X	X	X					16
Adenoma, multiple																			X	X							3
Carcinoma	X			X																							2
Carcinoma, multiple																											1
Urinary System																											
Kidney	+	+	+	+	+	+	+	+	+	+	+	+	+	+	+	+	+	+	+	+	+	+	+	+	+	+	50
Urinary bladder	+	+	+	+	+	+	+	+	+	+	+	+	+	+	+	+	+	+	+	+	+	+	+	+	+	+	49
Systemic Lesions																											
Multiple organs	+	+	+	+	+	+	+	+	+	+	+	+	+	+	+	+	+	+	+	+	+	+	+	+	+	+	50
Lymphoma malignant							X								X						X						7

TABLE D3
Statistical Analysis of Primary Neoplasms in Female Mice in the 2-Year Inhalation Study of Nitromethane

	0 ppm	188 ppm	375 ppm	750 ppm
Harderian Gland: Adenoma				
Overall rate ^a	5/50 (10%)	7/50 (14%)	16/50 (32%)	19/50 (38%)
Adjusted rate ^b	16.0%	21.4%	43.1%	45.9%
Terminal rate ^c	2/25 (8%)	4/28 (14%)	7/26 (27%)	14/36 (39%)
First incidence (days)	609	639	498	503
Life table test ^d	P=0.008	P=0.413	P=0.016	P=0.020
Logistic regression test ^d	P<0.001	P=0.380	P=0.008	P=0.003
Cochran-Armitage test ^d	P<0.001			
Fisher exact test ^d		P=0.380	P=0.006	P<0.001
Harderian Gland: Carcinoma				
Overall rate	1/50 (2%)	2/50 (4%)	4/50 (8%)	3/50 (6%)
Adjusted rate	2.9%	6.7%	14.1%	8.3%
Terminal rate	0/25 (0%)	1/28 (4%)	3/26 (12%)	3/36 (8%)
First incidence (days)	663	693	679	734 (T)
Life table test	P=0.364	P=0.506	P=0.195	P=0.425
Logistic regression test	P=0.305	P=0.501	P=0.194	P=0.365
Cochran-Armitage test	P=0.221			
Fisher exact test		P=0.500	P=0.181	P=0.309
Harderian Gland: Adenoma or Carcinoma				
Overall rate	6/50 (12%)	9/50 (18%)	20/50 (40%)	21/50 (42%)
Adjusted rate	18.4%	27.1%	53.5%	50.8%
Terminal rate	2/25 (8%)	5/28 (18%)	10/26 (38%)	16/36 (44%)
First incidence (days)	609	639	498	503
Life table test	P=0.010	P=0.324	P=0.005	P=0.019
Logistic regression test	P<0.001	P=0.175	P=0.002	P=0.002
Cochran-Armitage test	P<0.001			
Fisher exact test		P=0.288	P=0.001	P<0.001
Liver: Hepatocellular Adenoma				
Overall rate	14/50 (28%)	25/49 (51%)	17/49 (35%)	35/50 (70%)
Adjusted rate	45.5%	68.6%	49.0%	83.1%
Terminal rate	9/25 (36%)	17/28 (61%)	10/26 (38%)	29/36 (81%)
First incidence (days)	597	534	498	426
Life table test	P=0.022	P=0.048	P=0.395	P=0.009
Logistic regression test	P<0.001	P=0.013	P=0.364	P<0.001
Cochran-Armitage test	P<0.001			
Fisher exact test		P=0.016	P=0.308	P<0.001
Liver: Hepatocellular Carcinoma				
Overall rate	10/50 (20%)	14/49 (29%)	8/49 (16%)	12/50 (24%)
Adjusted rate	29.7%	35.7%	26.6%	25.6%
Terminal rate	3/25 (12%)	6/28 (21%)	6/26 (23%)	2/36 (6%)
First incidence (days)	576	534	548	426
Life table test	P=0.322N	P=0.296	P=0.362N	P=0.495N
Logistic regression test	P=0.329	P=0.195	P=0.383N	P=0.200
Cochran-Armitage test	P=0.505			
Fisher exact test		P=0.224	P=0.416N	P=0.405

TABLE D3

Statistical Analysis of Primary Neoplasms in Female Mice in the 2-Year Inhalation Study of Nitromethane (continued)

	0 ppm	188 ppm	375 ppm	750 ppm
Liver: Hepatocellular Adenoma or Carcinoma				
Overall rate	19/50 (38%)	34/49 (69%)	22/49 (45%)	40/50 (80%)
Adjusted rate	54.6%	82.4%	62.6%	86.9%
Terminal rate	10/25 (40%)	21/28 (75%)	14/26 (54%)	30/36 (83%)
First incidence (days)	576	534	498	426
Life table test	P=0.095	P=0.018	P=0.420	P=0.032
Logistic regression test	P=0.001	P<0.001	P=0.368	P<0.001
Cochran-Armitage test	P<0.001			
Fisher exact test		P=0.002	P=0.311	P<0.001
Lung: Alveolar/bronchiolar Adenoma				
Overall rate	3/50 (6%)	3/50 (6%)	2/49 (4%)	9/50 (18%)
Adjusted rate	11.5%	10.7%	4.3%	22.7%
Terminal rate	2/25 (8%)	3/28 (11%)	0/26 (0%)	6/36 (17%)
First incidence (days)	716	734 (T)	498	426
Life table test	P=0.065	P=0.610N	P=0.466N	P=0.186
Logistic regression test	P=0.022	P=0.632N	P=0.514N	P=0.083
Cochran-Armitage test	P=0.018			
Fisher exact test		P=0.661N	P=0.510N	P=0.061
Lung: Alveolar/bronchiolar Carcinoma				
Overall rate	0/50 (0%)	3/50 (6%)	5/49 (10%)	3/50 (6%)
Adjusted rate	0.0%	8.3%	15.0%	7.2%
Terminal rate	0/25 (0%)	1/28 (4%)	2/26 (8%)	1/36 (3%)
First incidence (days)	— ^c	534	602	503
Life table test	P=0.264	P=0.134	P=0.041	P=0.178
Logistic regression test	P=0.149	P=0.119	P=0.033	P=0.110
Cochran-Armitage test	P=0.159			
Fisher exact test		P=0.121	P=0.027	P=0.121
Lung: Alveolar/bronchiolar Adenoma or Carcinoma				
Overall rate	3/50 (6%)	6/50 (12%)	6/49 (12%)	12/50 (24%)
Adjusted rate	11.5%	18.5%	16.8%	28.7%
Terminal rate	2/25 (8%)	4/28 (14%)	2/26 (8%)	7/36 (19%)
First incidence (days)	716	534	498	426
Life table test	P=0.042	P=0.293	P=0.280	P=0.066
Logistic regression test	P=0.007	P=0.243	P=0.238	P=0.015
Cochran-Armitage test	P=0.007			
Fisher exact test		P=0.243	P=0.233	P=0.011
Mammary Gland: Adenoma or Carcinoma				
Overall rate	2/50 (4%)	2/50 (4%)	3/50 (6%)	0/50 (0%)
Adjusted rate	6.8%	5.9%	7.6%	0.0%
Terminal rate	1/25 (4%)	1/28 (4%)	0/26 (0%)	0/36 (0%)
First incidence (days)	667	569	548	—
Life table test	P=0.151N	P=0.685N	P=0.517	P=0.179N
Logistic regression test	P=0.208N	P=0.695N	P=0.497	P=0.217N
Cochran-Armitage test	P=0.199N			
Fisher exact test		P=0.691N	P=0.500	P=0.247N

TABLE D3

Statistical Analysis of Primary Neoplasms in Female Mice in the 2-Year Inhalation Study of Nitromethane (continued)

	0 ppm	188 ppm	375 ppm	750 ppm
Ovary: Cystadenoma				
Overall rate	2/47 (4%)	1/47 (2%)	0/48 (0%)	3/48 (6%)
Adjusted rate	4.9%	3.6%	0.0%	8.1%
Terminal rate	0/24 (0%)	1/28 (4%)	0/26 (0%)	2/34 (6%)
First incidence (days)	576	734 (T)	—	687
Life table test	P=0.433	P=0.491N	P=0.232N	P=0.609
Logistic regression test	P=0.354	P=0.502N	P=0.236N	P=0.505
Cochran-Armitage test	P=0.345			
Fisher exact test		P=0.500N	P=0.242N	P=0.510
Ovary: Cystadenoma or Cystadenocarcinoma				
Overall rate	2/47 (4%)	1/47 (2%)	0/48 (0%)	4/48 (8%)
Adjusted rate	4.9%	3.6%	0.0%	10.3%
Terminal rate	0/24 (0%)	1/28 (4%)	0/26 (0%)	2/34 (6%)
First incidence (days)	576	734 (T)	—	657
Life table test	P=0.247	P=0.491N	P=0.232N	P=0.453
Logistic regression test	P=0.174	P=0.502N	P=0.236N	P=0.338
Cochran-Armitage test	P=0.171			
Fisher exact test		P=0.500N	P=0.242N	P=0.349
Pituitary Gland (Pars Distalis): Adenoma				
Overall rate	9/50 (18%)	10/46 (22%)	8/48 (17%)	4/50 (8%)
Adjusted rate	30.3%	33.9%	32.0%	10.8%
Terminal rate	6/25 (24%)	8/27 (30%)	8/25 (32%)	3/36 (8%)
First incidence (days)	597	656	734 (T)	729
Life table test	P=0.014N	P=0.544	P=0.494N	P=0.036N
Logistic regression test	P=0.019N	P=0.456	P=0.470N	P=0.063N
Cochran-Armitage test	P=0.064N			
Fisher exact test		P=0.419	P=0.537N	P=0.117N
Thyroid Gland (Follicular Cell): Adenoma				
Overall rate	4/50 (8%)	1/48 (2%)	1/48 (2%)	1/50 (2%)
Adjusted rate	12.2%	2.6%	4.0%	2.8%
Terminal rate	2/25 (8%)	0/28 (0%)	1/25 (4%)	1/36 (3%)
First incidence (days)	385	581	734 (T)	734 (T)
Life table test	P=0.096N	P=0.177N	P=0.180N	P=0.116N
Logistic regression test	P=0.144N	P=0.196N	P=0.196N	P=0.198N
Cochran-Armitage test	P=0.134N			
Fisher exact test		P=0.194N	P=0.194N	P=0.181N
Uterus: Hemangioma				
Overall rate	2/50 (4%)	5/50 (10%)	0/50 (0%)	0/50 (0%)
Adjusted rate	6.3%	15.7%	0.0%	0.0%
Terminal rate	1/25 (4%)	3/28 (11%)	0/26 (0%)	0/36 (0%)
First incidence (days)	597	569	—	—
Life table test	P=0.034N	P=0.239	P=0.230N	P=0.191N
Logistic regression test	P=0.048N	P=0.217	P=0.238N	P=0.242N
Cochran-Armitage test	P=0.052N			
Fisher exact test		P=0.218	P=0.247N	P=0.247N

TABLE D3

Statistical Analysis of Primary Neoplasms in Female Mice in the 2-Year Inhalation Study of Nitromethane (continued)

	0 ppm	188 ppm	375 ppm	750 ppm
Uterus: Stromal Polyp				
Overall rate	4/50 (8%)	2/50 (4%)	1/50 (2%)	3/50 (6%)
Adjusted rate	14.0%	7.1%	3.8%	8.0%
Terminal rate	3/25 (12%)	2/28 (7%)	1/26 (4%)	2/36 (6%)
First incidence (days)	576	734 (T)	734 (T)	721
Life table test	P=0.308N	P=0.299N	P=0.169N	P=0.327N
Logistic regression test	P=0.361N	P=0.333N	P=0.166N	P=0.431N
Cochran-Armitage test	P=0.456N			
Fisher exact test		P=0.339N	P=0.181N	P=0.500N
All Organs: Hemangioma				
Overall rate	3/50 (6%)	6/50 (12%)	0/50 (0%)	1/50 (2%)
Adjusted rate	10.2%	19.0%	0.0%	2.4%
Terminal rate	2/25 (8%)	4/28 (14%)	0/26 (0%)	0/36 (0%)
First incidence (days)	597	569	—	687
Life table test	P=0.044N	P=0.275	P=0.115N	P=0.215N
Logistic regression test	P=0.064N	P=0.243	P=0.116N	P=0.292N
Cochran-Armitage test	P=0.077N			
Fisher exact test		P=0.243	P=0.121N	P=0.309N
All Organs: Hemangiosarcoma				
Overall rate	4/50 (8%)	1/50 (2%)	5/50 (10%)	0/50 (0%)
Adjusted rate	15.1%	3.6%	16.2%	0.0%
Terminal rate	3/25 (12%)	1/28 (4%)	3/26 (12%)	0/36 (0%)
First incidence (days)	707	734 (T)	568	—
Life table test	P=0.063N	P=0.152N	P=0.526	P=0.028N
Logistic regression test	P=0.081N	P=0.160N	P=0.533	P=0.031N
Cochran-Armitage test	P=0.114N			
Fisher exact test		P=0.181N	P=0.500	P=0.059N
All Organs: Hemangioma or Hemangiosarcoma				
Overall rate	7/50 (14%)	7/50 (14%)	5/50 (10%)	1/50 (2%)
Adjusted rate	24.7%	22.4%	16.2%	2.4%
Terminal rate	5/25 (20%)	5/28 (18%)	3/26 (12%)	0/36 (0%)
First incidence (days)	597	569	568	687
Life table test	P=0.006N	P=0.556N	P=0.352N	P=0.011N
Logistic regression test	P=0.011N	P=0.612N	P=0.347N	P=0.020N
Cochran-Armitage test	P=0.019N			
Fisher exact test		P=0.613N	P=0.380N	P=0.030N
All Organs: Histiocytic Sarcoma				
Overall rate	2/50 (4%)	0/50 (0%)	3/50 (6%)	0/50 (0%)
Adjusted rate	7.1%	0.0%	9.7%	0.0%
Terminal rate	1/25 (4%)	0/28 (0%)	1/26 (4%)	0/36 (0%)
First incidence (days)	693	—	631	—
Life table test	P=0.221N	P=0.227N	P=0.524	P=0.172N
Logistic regression test	P=0.260N	P=0.235N	P=0.522	P=0.201N
Cochran-Armitage test	P=0.296N			
Fisher exact test		P=0.247N	P=0.500	P=0.247N

TABLE D3
Statistical Analysis of Primary Neoplasms in Female Mice in the 2-Year Inhalation Study of Nitromethane (continued)

	0 ppm	188 ppm	375 ppm	750 ppm
All Organs: Malignant Lymphoma				
Overall rate	9/50 (18%)	7/50 (14%)	7/50 (14%)	7/50 (14%)
Adjusted rate	23.4%	20.7%	21.3%	17.5%
Terminal rate	2/25 (8%)	4/28 (14%)	3/26 (12%)	4/36 (11%)
First incidence (days)	385	416	609	603
Life table test	P=0.196N	P=0.382N	P=0.368N	P=0.223N
Logistic regression test	P=0.389N	P=0.397N	P=0.404N	P=0.440N
Cochran-Armitage test	P=0.369N			
Fisher exact test		P=0.393N	P=0.393N	P=0.393N
All Organs: Benign Neoplasms				
Overall rate	31/50 (62%)	39/50 (78%)	33/50 (66%)	43/50 (86%)
Adjusted rate	78.8%	95.1%	86.2%	91.4%
Terminal rate	17/25 (68%)	26/28 (93%)	21/26 (81%)	32/36 (89%)
First incidence (days)	385	534	498	51
Life table test	P=0.422N	P=0.208	P=0.522	P=0.533
Logistic regression test	P=0.041	P=0.043	P=0.512	P=0.011
Cochran-Armitage test	P=0.014			
Fisher exact test		P=0.063	P=0.418	P=0.006
All Organs: Malignant Neoplasms				
Overall rate	26/50 (52%)	24/50 (48%)	28/50 (56%)	21/50 (42%)
Adjusted rate	61.1%	56.6%	67.4%	42.9%
Terminal rate	9/25 (36%)	11/28 (39%)	13/26 (50%)	8/36 (22%)
First incidence (days)	385	416	548	426
Life table test	P=0.048N	P=0.385N	P=0.515	P=0.055N
Logistic regression test	P=0.404N	P=0.398N	P=0.462	P=0.520N
Cochran-Armitage test	P=0.215N			
Fisher exact test		P=0.421N	P=0.421	P=0.212N
All Organs: Benign or Malignant Neoplasms				
Overall rate	38/50 (76%)	45/50 (90%)	43/50 (86%)	46/50 (92%)
Adjusted rate	86.2%	100.0%	97.7%	92.0%
Terminal rate	19/25 (76%)	28/28 (100%)	25/26 (96%)	32/36 (89%)
First incidence (days)	385	416	498	51
Life table test	P=0.157N	P=0.288	P=0.368	P=0.286N
Logistic regression test	P=0.070	P=0.040	P=0.198	P=0.040
Cochran-Armitage test	P=0.037			
Fisher exact test		P=0.054	P=0.154	P=0.027

(T) Terminal sacrifice

^a Number of neoplasm-bearing animals/number of animals examined. Denominator is number of animals examined microscopically for liver, lung, ovary, pituitary gland, and thyroid gland; for other tissues, denominator is number of animals necropsied.

^b Kaplan-Meier estimated neoplasm incidence at the end of the study after adjustment for intercurrent mortality

^c Observed incidence at terminal kill

^d Beneath the control incidence are the P values associated with the trend test. Beneath the exposed group incidence are the P values corresponding to pairwise comparisons between the controls and that exposed group. The life table test regards neoplasms in animals dying prior to terminal kill as being (directly or indirectly) the cause of death. The logistic regression test regards these lesions as nonfatal. The Cochran-Armitage and Fisher exact tests compare directly the overall incidence rates. For all tests, a negative trend or a lower incidence in an exposure group is indicated by N.

^e Not applicable; no neoplasms in animal group

TABLE D4a
Historical Incidence of Harderian Gland Neoplasms in Chamber Control Female B6C3F₁ Mice^a

Study	Incidence in Controls		
	Adenoma	Carcinoma	Adenoma or Carcinoma
Historical Incidence at Battelle Pacific Northwest Laboratories			
1,3-Butadiene	8/50	0/50	8/50
Acetonitrile	3/49	0/49	3/49
Allyl glycidyl ether	0/50	0/50	0/50
2-Chloroacetophenone	0/50	0/50	0/50
<i>l</i> -Epinephrine Hydrochloride	1/50	1/50	2/50
Chloroethane	2/49	0/49	2/49
Hexachlorocyclopentadiene	4/49	1/49	5/49
<i>o</i> -Chlorobenzalmononitrile (CS ₂)	2/50	2/50	4/50
Ozone	1/50	2/50	3/50
Total	21/447 (4.7%)	6/447 (1.3%)	27/447 (6.0%)
Standard deviation	5.0%	1.7%	5.0%
Range	0%-16%	0%-4%	0%-16%
Overall Historical Incidence			
Total	26/941 (2.8%)	6/941 (0.6%)	32/941 (3.4%)
Standard deviation	4.0%	1.4%	4.4%
Range	0%-16%	0%-4%	0%-16%

^a Data as of 12 May 1995

TABLE D4b
Historical Incidence of Hepatocellular Neoplasms in Chamber Control Female B6C3F₁ Mice^a

Study	Incidence in Controls		
	Adenoma	Carcinoma	Adenoma or Carcinoma
Historical Incidence at Battelle Pacific Northwest Laboratories			
1,3-Butadiene	11/49	4/49	15/49
Acetonitrile	4/49	7/49	9/49
Allyl glycidyl ether	1/50	5/50	6/50
2-Chloroacetophenone	4/50	8/50	12/50
<i>l</i> -Epinephrine Hydrochloride	2/50	1/50	3/50
Chloroethane	0/49	3/49	3/49
Hexachlorocyclopentadiene	5/49	4/49	9/49
<i>o</i> -Chlorobenzal malonitrile (CS2)	4/50	7/50	11/50
Ozone	20/50	15/50	27/50
Total	51/446 (11.4%)	54/446 (12.1%)	95/446 (21.3%)
Standard deviation	12.4%	8.1%	14.8%
Range	0%-40%	2%-30%	6%-54%
Overall Historical Incidence			
Total	114/937 (12.2%)	103/937 (11.0%)	200/937 (21.3%)
Standard deviation	9.7%	6.7%	11.9%
Range	0%-40%	0%-30%	3%-54%

^a Data as of 12 May 1995

TABLE D4c

Historical Incidence of Alveolar/bronchiolar Neoplasms in Chamber Control Female B6C3F₁ Mice^a

Study	Incidence in Controls		
	Adenoma	Carcinoma	Adenoma or Carcinoma
Historical Incidence at Battelle Pacific Northwest Laboratories			
1,3-Butadiene	4/50	0/50	4/50
Acetonitrile	7/49	1/49	8/49
Allyl glycidyl ether	0/50	0/50	0/50
2-Chloroacetophenone	4/50	3/50	6/50
<i>l</i> -Epinephrine Hydrochloride	3/50	2/50	5/50
Chloroethane	2/49	3/49	5/49
Hexachlorocyclopentadiene	4/48	3/48	7/48
<i>o</i> -Chlorobenzalmononitrile (CS2)	4/50	1/50	5/50
Ozone	4/50	2/50	6/50
Total	32/446 (7.2%)	15/446 (3.4%)	46/446 (10.3%)
Standard deviation	3.8%	2.4%	4.6%
Range	0%-14%	0%-6%	0%-16%
Overall Historical Incidence			
Total	61/939 (6.5%)	38/939 (4.1%)	97/939 (10.3%)
Standard deviation	3.2%	3.2%	3.7%
Range	0%-14%	0%-12%	0%-16%

^a Data as of 12 May 1995

TABLE D5
Summary of the Incidence of Nonneoplastic Lesions in Female Mice in the 2-Year Inhalation Study of Nitromethane^a

	0 ppm	188 ppm	375 ppm	750 ppm
Disposition Summary				
Animals initially in study	50	50	50	50
Early deaths				
Accidental deaths	2		1	
Moribund	16	17	20	12
Natural deaths	7	5	3	2
Survivors				
Died last week of study		1		
Terminal sacrifice	25	27	26	36
Animals examined microscopically	50	50	50	50
Alimentary System				
Esophagus (48)		(48)	(49)	(49)
Epithelium, hyperplasia	1 (2%)			1 (2%)
Gallbladder (40)		(45)	(45)	(46)
Inflammation, chronic		1 (2%)		
Inflammation, suppurative		1 (2%)	1 (2%)	
Intestine large, cecum (49)		(46)	(47)	(50)
Diverticulum				1 (2%)
Muscularis, hyperplasia	1 (2%)			
Intestine small, duodenum (48)		(43)	(45)	(49)
Cyst	1 (2%)			
Peyer's patch, hyperplasia		1 (2%)		
Intestine small, jejunum (47)		(45)	(47)	(48)
Epithelium, hyperplasia				1 (2%)
Liver (50)		(49)	(49)	(50)
Angiectasis				1 (2%)
Basophilic focus	1 (2%)			1 (2%)
Eosinophilic focus	4 (8%)	7 (14%)	11 (22%)	15 (30%)
Hematopoietic cell proliferation	2 (4%)	4 (8%)	2 (4%)	2 (4%)
Inflammation, chronic	1 (2%)	3 (6%)		1 (2%)
Mixed cell focus		2 (4%)	1 (2%)	1 (2%)
Necrosis	2 (4%)	2 (4%)	3 (6%)	
Vacuolization cytoplasmic				1 (2%)
Bile duct, cyst		1 (2%)		
Centrilobular, degeneration, fatty	1 (2%)	1 (2%)		
Centrilobular, necrosis	1 (2%)	3 (6%)		
Mesentery (7)		(14)	(8)	(11)
Hemorrhage		1 (7%)		
Inflammation, suppurative			1 (13%)	
Fat, hemorrhage			1 (13%)	
Fat, necrosis	6 (86%)	11 (79%)	5 (63%)	10 (91%)
Fat, thrombosis		1 (7%)		
Pancreas (50)		(48)	(48)	(50)
Atrophy	2 (4%)	2 (4%)	1 (2%)	2 (4%)
Basophilic focus	2 (4%)	1 (2%)	1 (2%)	1 (2%)
Necrosis				1 (2%)
Duct, cyst			1 (2%)	2 (4%)
Duct, inflammation, suppurative				1 (2%)

^a Number of animals examined microscopically at the site and the number of animals with lesion

TABLE D5

Summary of the Incidence of Nonneoplastic Lesions in Female Mice in the 2-Year Inhalation Study of Nitromethane
(continued)

	0 ppm	188 ppm	375 ppm	750 ppm
Alimentary System (continued)				
Salivary glands	(49)	(48)	(49)	(50)
Atrophy			1 (2%)	
Stomach, forestomach	(50)	(48)	(49)	(50)
Angiectasis				1 (2%)
Inflammation, suppurative	1 (2%)	1 (2%)		
Ulcer	3 (6%)			1 (2%)
Epithelium, hyperplasia	1 (2%)	4 (8%)	3 (6%)	1 (2%)
Stomach, glandular	(49)	(48)	(48)	(50)
Degeneration, hyaline				1 (2%)
Inflammation		1 (2%)	1 (2%)	
Ulcer	1 (2%)		1 (2%)	1 (2%)
Cardiovascular System				
Blood vessel		(1)	(2)	
Aorta, mineralization		1 (100%)	1 (50%)	
Heart	(50)	(50)	(50)	(50)
Cardiomyopathy	13 (26%)	23 (46%)	19 (38%)	18 (36%)
Mineralization	1 (2%)			
Thrombosis				1 (2%)
Artery, inflammation	1 (2%)			
Endothelium, hyperplasia	1 (2%)			
Endocrine System				
Adrenal cortex	(50)	(48)	(49)	(50)
Degeneration, cystic	1 (2%)			3 (6%)
Hyperplasia		1 (2%)		2 (4%)
Hypertrophy	2 (4%)	4 (8%)	5 (10%)	3 (6%)
Capsule, hyperplasia		2 (4%)		2 (4%)
Adrenal medulla	(50)	(48)	(49)	(49)
Hyperplasia	1 (2%)	1 (2%)	1 (2%)	1 (2%)
Islets, pancreatic	(50)	(48)	(47)	(50)
Hyperplasia			1 (2%)	1 (2%)
Parathyroid gland	(33)	(34)	(33)	(34)
Cyst		1 (3%)		
Pituitary gland	(50)	(46)	(48)	(50)
Pars distalis, angiectasis		1 (2%)		
Pars distalis, hyperplasia	11 (22%)	20 (43%)	11 (23%)	18 (36%)
Pars intermedia, hyperplasia	1 (2%)			
Pars intermedia, hypertrophy		1 (2%)		
Thyroid gland	(50)	(48)	(48)	(50)
Follicular cell, hyperplasia	5 (10%)	4 (8%)	3 (6%)	5 (10%)
General Body System				
None				

TABLE D5
Summary of the Incidence of Nonneoplastic Lesions in Female Mice in the 2-Year Inhalation Study of Nitromethane
 (continued)

	0 ppm	188 ppm	375 ppm	750 ppm
Genital System				
Ovary	(47)	(47)	(48)	(48)
Angiectasis	4 (9%)	2 (4%)	1 (2%)	
Atrophy	14 (30%)	16 (34%)	14 (29%)	13 (27%)
Cyst	13 (28%)	14 (30%)	16 (33%)	13 (27%)
Hyperplasia, tubular	3 (6%)	2 (4%)	2 (4%)	
Thrombosis	1 (2%)			1 (2%)
Bilateral, cyst		1 (2%)		
Granulosa cell, hyperplasia		1 (2%)		
Interstitial cell, hyperplasia			1 (2%)	
Uterus	(50)	(49)	(49)	(50)
Adenomyosis			1 (2%)	
Angiectasis	2 (4%)	2 (4%)	4 (8%)	
Hemorrhage			1 (2%)	
Hydrometra	3 (6%)	4 (8%)	5 (10%)	10 (20%)
Hyperplasia, cystic	4 (8%)	6 (12%)	3 (6%)	2 (4%)
Inflammation, suppurative				1 (2%)
Thrombosis		1 (2%)	2 (4%)	
Myometrium, hyperplasia			1 (2%)	
Hematopoietic System				
Bone marrow	(50)	(48)	(49)	(50)
Hyperplasia		3 (6%)		
Infiltration cellular, mast cell	1 (2%)			
Lymph node	(8)	(6)	(5)	(6)
Ectasia	1 (13%)			
Hyperplasia			1 (20%)	
Iliac, hematopoietic cell proliferation			1 (20%)	
Iliac, hyperplasia		2 (33%)		1 (17%)
Pancreatic, hyperplasia				1 (17%)
Renal, hematopoietic cell proliferation			1 (20%)	
Renal, hyperplasia		2 (33%)	1 (20%)	2 (33%)
Lymph node, bronchial	(39)	(36)	(40)	(40)
Hyperplasia	4 (10%)	5 (14%)	3 (8%)	2 (5%)
Lymph node, mandibular	(43)	(34)	(38)	(43)
Hematopoietic cell proliferation		1 (3%)		
Hyperplasia	1 (2%)	1 (3%)	5 (13%)	5 (12%)
Lymph node, mesenteric	(48)	(46)	(46)	(48)
Angiectasis	1 (2%)		1 (2%)	2 (4%)
Congestion	1 (2%)	1 (2%)		
Hyperplasia	6 (13%)	9 (20%)	3 (7%)	4 (8%)
Infiltration cellular, mast cell	1 (2%)			
Lymph node, mediastinal	(38)	(37)	(35)	(41)
Hyperplasia	6 (16%)	5 (14%)	3 (9%)	2 (5%)
Spleen	(50)	(48)	(49)	(50)
Angiectasis			1 (2%)	
Hematopoietic cell proliferation	10 (20%)	13 (27%)	10 (20%)	12 (24%)
Hyperplasia, lymphoid	5 (10%)	10 (21%)	6 (12%)	8 (16%)
Infiltration cellular, mast cell	1 (2%)			
Thymus	(43)	(39)	(41)	(47)
Atrophy	1 (2%)	2 (5%)	2 (5%)	
Hyperplasia, lymphoid	3 (7%)	2 (5%)	6 (15%)	5 (11%)
Infiltration cellular, mast cell	1 (2%)			
Necrosis		1 (3%)		1 (2%)

TABLE D5

Summary of the Incidence of Nonneoplastic Lesions in Female Mice in the 2-Year Inhalation Study of Nitromethane
(continued)

	0 ppm	188 ppm	375 ppm	750 ppm
Integumentary System				
Mammary gland	(50)	(48)	(49)	(50)
Hyperplasia				2 (4%)
Skin	(49)	(47)	(50)	(50)
Cyst epithelial inclusion				1 (2%)
Inflammation, chronic	1 (2%)			
Inflammation, suppurative	1 (2%)	1 (2%)	1 (2%)	
Musculoskeletal System				
Bone	(50)	(50)	(50)	(50)
Arthrosis	1 (2%)			
Fibrous osteodystrophy	17 (34%)	18 (36%)	18 (36%)	12 (24%)
Hyperostosis			1 (2%)	
Nervous System				
Brain	(50)	(50)	(49)	(50)
Meninges, infiltration cellular, mononuclear cell		2 (4%)	1 (2%)	
Respiratory System				
Larynx	(49)	(48)	(49)	(50)
Inflammation, suppurative		1 (2%)		
Metaplasia, squamous		1 (2%)		
Lung	(50)	(50)	(49)	(50)
Hemorrhage	1 (2%)	1 (2%)	1 (2%)	2 (4%)
Infiltration cellular, histiocyte		1 (2%)	6 (12%)	4 (8%)
Inflammation, chronic	2 (4%)		1 (2%)	1 (2%)
Pigmentation, hemosiderin			2 (4%)	1 (2%)
Alveolar epithelium, hyperplasia	3 (6%)	1 (2%)	5 (10%)	1 (2%)
Bronchus, infiltration cellular, mixed cell	1 (2%)			
Mediastinum, hemorrhage, focal	1 (2%)			
Mediastinum, infiltration cellular, mast cell	1 (2%)			
Mediastinum, inflammation, chronic				1 (2%)
Mediastinum, necrosis		1 (2%)		
Perivascular, inflammation, chronic		1 (2%)		1 (2%)
Nose	(50)	(49)	(50)	(50)
Inflammation, chronic, focal			1 (2%)	
Inflammation, suppurative	2 (4%)		4 (8%)	1 (2%)
Glands, hyperplasia				1 (2%)
Nasolacrimal duct, inflammation, suppurative	1 (2%)		3 (6%)	3 (6%)
Olfactory epithelium, atrophy, focal	2 (4%)	6 (12%)		
Olfactory epithelium, degeneration		22 (45%)	50 (100%)	50 (100%)
Olfactory epithelium, metaplasia		2 (4%)	46 (92%)	48 (96%)
Respiratory epithelium, degeneration, hyaline	16 (32%)	39 (80%)	50 (100%)	50 (100%)
Respiratory epithelium, metaplasia, squamous			1 (2%)	

TABLE D5

Summary of the Incidence of Nonneoplastic Lesions in Female Mice in the 2-Year Inhalation Study of Nitromethane
(continued)

	0 ppm	188 ppm	375 ppm	750 ppm
Special Senses System				
Eye		(1)	(1)	
Inflammation		1 (100%)	1 (100%)	
Harderian gland	(49)	(49)	(50)	(50)
Fibrosis, focal				1 (2%)
Hyperplasia	3 (6%)	2 (4%)	5 (10%)	1 (2%)
Urinary System				
Kidney	(50)	(48)	(49)	(50)
Amyloid deposition		1 (2%)		
Hydronephrosis			1 (2%)	
Metaplasia, osseous	1 (2%)	2 (4%)	3 (6%)	1 (2%)
Nephropathy	12 (24%)	5 (10%)	7 (14%)	7 (14%)
Renal tubule, degeneration				1 (2%)
Renal tubule, mineralization		1 (2%)	1 (2%)	
Urinary bladder	(49)	(47)	(47)	(49)
Inflammation, suppurative	1 (2%)	2 (4%)		
Transitional epithelium, hyperplasia		1 (2%)		

APPENDIX E

GENETIC TOXICOLOGY

SALMONELLA TYPHIMURIUM MUTAGENICITY TEST PROTOCOL	228
CHINESE HAMSTER OVARY CELL CYTOGENETICS PROTOCOLS	228
MOUSE PERIPHERAL BLOOD MICRONUCLEUS TEST PROTOCOL	229
RESULTS	230
TABLE E1 Mutagenicity of Nitromethane in <i>Salmonella typhimurium</i>	231
TABLE E2 Induction of Sister Chromatid Exchanges in Chinese Hamster Ovary Cells by Nitromethane	232
TABLE E3 Induction of Chromosomal Aberrations in Chinese Hamster Ovary Cells by Nitromethane	233
TABLE E4 Frequency of Micronuclei in Peripheral Blood Erythrocytes of Mice Following Treatment with Nitromethane by Inhalation for 13 Weeks	234

GENETIC TOXICOLOGY

***SALMONELLA TYPHIMURIUM* MUTAGENICITY TEST PROTOCOL**

Testing was performed as reported by Mortelmans *et al.* (1986). Nitromethane was sent to the laboratory as a coded aliquot from Radian Corporation (Austin, TX). It was incubated with the *Salmonella typhimurium* tester strains TA98, TA100, TA1535, and TA1537 either in buffer or S9 mix (metabolic activation enzymes and cofactors from Aroclor 1254-induced male Sprague-Dawley rat or Syrian hamster liver) for 20 minutes at 37° C. Top agar supplemented with *l*-histidine and *d*-biotin was added, and the contents of the tubes were mixed and poured onto the surfaces of minimal glucose agar plates. Histidine-independent mutant colonies arising on these plates were counted following incubation for 2 days at 37° C.

Each trial consisted of triplicate plates of concurrent positive and negative controls and five doses of nitromethane. The high dose was limited by experimental design to 10,000 µg/plate. All trials were repeated.

In this assay, a positive response is defined as a reproducible, dose-related increase in histidine-independent (revertant) colonies in any one strain/activation combination. An equivocal response is defined as an increase in revertants that is not dose related, not reproducible, or not of sufficient magnitude to support a determination of mutagenicity. A negative response is obtained when no increase in revertant colonies is observed following chemical treatment. There is no minimum percentage or fold increase required for a chemical to be judged positive or weakly positive.

CHINESE HAMSTER OVARY CELL CYTOGENETICS PROTOCOLS

Testing was performed as reported by Galloway *et al.* (1987). Nitromethane was sent to the laboratory as a coded aliquot by Radian Corporation. It was tested in cultured Chinese hamster ovary (CHO) cells for induction of sister chromatid exchanges (SCEs) and chromosomal aberrations (Abs), both in the presence and absence of Aroclor 1254-induced male Sprague-Dawley rat liver S9 and cofactor mix. Cultures were handled under gold lights to prevent photolysis of bromodeoxyuridine-substituted DNA. Each test consisted of concurrent solvent and positive controls and of three doses of nitromethane. In the absence of toxicity, the high dose was limited to approximately 5,000 µg/mL. A single flask per dose was used, and tests yielding equivocal or positive results were repeated.

Sister Chromatid Exchange Test: In the SCE test without S9, CHO cells were incubated for 26 hours with nitromethane in McCoy's 5A medium. Bromodeoxyuridine (BrdU) was added 2 hours after culture initiation. After 26 hours, the medium containing nitromethane was removed and replaced with fresh medium plus BrdU and Colcemid, and incubation was continued for 2 hours. Cells were then harvested by mitotic shake-off, fixed, and stained with Hoechst 33258 and Giemsa. In the SCE test with S9, cells were incubated with nitromethane, serum-free medium, and S9 for 2 hours. The medium was then removed and replaced with medium containing serum and BrdU and no nitromethane and incubation proceeded for an additional 26 hours, with Colcemid present for the final 2 hours. Harvesting and staining were the same as for cells treated without S9. All slides were scored blind and those from a single test were read by the same person. Fifty second-division metaphase cells were scored for frequency of SCEs/cell from each dose level.

Statistical analyses were conducted on the slopes of the dose-response curves and the individual dose points (Galloway *et al.*, 1987). An SCE frequency 20% above the concurrent solvent control value was chosen as a statistically conservative positive response. The probability of this level of difference

occurring by chance at one dose point is less than 0.01; the probability for such a chance occurrence at two dose points is less than 0.001. An increase of 20% or greater at any single dose was considered weak evidence of activity; increases at two or more doses resulted in a determination that the trial was positive. A statistically significant trend ($P < 0.005$) in the absence of any responses reaching 20% above background led to a call of equivocal.

Chromosomal Aberrations Test: In the Abs test without S9, cells were incubated in McCoy's 5A medium with nitromethane for 11.5 hours; Colcemid was added, and incubation continued for 2 hours. The cells were then harvested by mitotic shake-off, fixed, and stained with Giemsa. For the Abs test with S9, cells were treated with nitromethane and S9 for 2 hours, after which the treatment medium was removed and the cells were incubated for 11.5 hours in fresh medium, with Colcemid present for the final 2 hours. Cells were harvested in the same manner as for the treatment without S9.

Cells were selected for scoring on the basis of good morphology and completeness of karyotype (21 ± 2 chromosomes). All slides were scored blind and those from a single test were read by the same person. Two hundred first-division metaphase cells were scored at each dose level. Classes of aberrations included simple (breaks and terminal deletions), complex (rearrangements and translocations), and other (pulverized cells, despiralized chromosomes, and cells containing 10 or more aberrations).

Chromosomal aberration data are presented as percentages of cells with aberrations. To arrive at a statistical call for a trial, analyses were conducted on both the dose response curve and individual dose points. For a single trial, a statistically significant ($P \leq 0.05$) difference for one dose point and a significant trend ($P \leq 0.015$) were considered weak evidence for a positive response; significant differences for two or more doses indicated the trial was positive. A positive trend test in the absence of a statistically significant increase at any one dose resulted in an equivocal call (Galloway *et al.*, 1987). Ultimately, the trial calls were based on a consideration of the statistical analyses as well as the biological information available to the reviewers.

MOUSE PERIPHERAL BLOOD MICRONUCLEUS TEST PROTOCOL

A detailed discussion of this assay can be found in MacGregor *et al.* (1990). Peripheral blood samples were obtained from male and female B6C3F₁ mice at the end of the 13-week toxicity study. Smears were immediately prepared and fixed in absolute methanol and were later stained with a chromatin-specific fluorescent dye mixture of Hoechst 33258/pyronin Y (MacGregor *et al.*, 1983) and coded. Slides were scanned to determine the frequency of micronuclei in 2,000 normochromatic erythrocytes (NCEs) in each animal per dose group. The criteria of Schmid (1976) were used to define micronuclei, with the additional requirement that the micronuclei exhibit the characteristic fluorescent emissions of DNA (blue with 360 nm and orange with 510 nm ultraviolet illumination); the minimum size limit was approximately one-twentieth the diameter of the NCE cell.

The results were tabulated as the mean of the pooled results from all animals within a treatment group, plus or minus the standard error of the mean. The frequency of micronucleated cells among NCEs was analyzed by a statistical software package that tested for increasing trend over exposure groups with a one-tailed Cochran-Armitage trend test, followed by pairwise comparisons between each exposure group and the control group (Margolin *et al.*, 1990). In the presence of excess binomial variation, as detected by a binomial dispersion test, the binomial variance of the Cochran-Armitage test was adjusted upward in proportion to the excess variation. In the micronucleus test, an individual trial is considered positive if the trend test P value is less than or equal to 0.025 or if the P value for any exposure group is less than or equal to 0.025 divided by the number of exposed groups. A final call of positive for micronucleus induction is preferably based on reproducibly positive trials (as noted above). Ultimately, the final call is

determined by the scientific staff after considering the results of statistical analyses, the reproducibility of any effects observed, and the magnitudes of those effects.

RESULTS

Nitromethane was not mutagenic *in vitro* or *in vivo*. Nitromethane (100 to 10,000 $\mu\text{g}/\text{plate}$) was negative for induction of mutations in *S. typhimurium* strains TA98, TA100, TA1535, and TA1537 when tested with or without induced S9 enzymes (Table E1; Mortelmans *et al.*, 1986). No induction of SCEs (Table E2) or Abs (Table E3) was observed in cultured CHO cells treated with up to 5,000 $\mu\text{g}/\text{mL}$ nitromethane. Nitromethane administered by inhalation for 13 weeks at concentrations up to 1,500 ppm did not induce increased frequencies of micronucleated erythrocytes in the peripheral blood of male or female mice (Table E4).

TABLE E1
Mutagenicity of Nitromethane in *Salmonella typhimurium*^a

Strain	Dose ($\mu\text{g}/\text{plate}$)	Revertants/plate ^b					
		-S9		+10% hamster S9		+10% rat S9	
		Trial 1	Trial 2	Trial 1	Trial 2	Trial 1	Trial 2
TA100	0	64 \pm 1.9	82 \pm 2.8	54 \pm 1.7	104 \pm 6.8	55 \pm 2.3	101 \pm 6.1
	100	70 \pm 2.3	104 \pm 2.2	92 \pm 11.4	113 \pm 7.5	86 \pm 5.5	109 \pm 11.0
	333.3	74 \pm 3.2	106 \pm 10.3	93 \pm 4.4	111 \pm 0.6	88 \pm 2.1	89 \pm 4.7
	1,000	64 \pm 1.8	92 \pm 4.5	85 \pm 4.3	101 \pm 8.7	88 \pm 0.6	94 \pm 5.5
	3,333.3	60 \pm 4.2	101 \pm 11.3	90 \pm 6.7	105 \pm 10.0	91 \pm 10.3	101 \pm 8.4
	10,000	27 \pm 15.3 ^c	127 \pm 9.1	96 \pm 5.5	120 \pm 3.2	84 \pm 5.7	99 \pm 6.1
Trial summary		Negative	Negative	Negative	Negative	Negative	Negative
Positive control ^d		222 \pm 20.9	461 \pm 5.9	2,168 \pm 100.8	1,720 \pm 67.7	738 \pm 28.9	577 \pm 26.1
TA1535	0	7 \pm 1.2	23 \pm 2.0	6 \pm 2.3	11 \pm 1.5	8 \pm 0.6	9 \pm 1.2
	100	7 \pm 1.5	19 \pm 2.6	8 \pm 2.9	10 \pm 2.8	5 \pm 0.9	13 \pm 2.8
	333.3	9 \pm 1.2	19 \pm 1.3	5 \pm 1.0	10 \pm 1.5	6 \pm 1.5	13 \pm 2.1
	1,000	10 \pm 1.2	21 \pm 2.0	4 \pm 1.0	11 \pm 3.2	5 \pm 0.9	9 \pm 2.0
	3,333.3	12 \pm 2.7	20 \pm 3.0	4 \pm 2.0	12 \pm 1.8	6 \pm 0.6	10 \pm 1.9
	10,000	5 \pm 2.0	23 \pm 1.5	5 \pm 1.5	14 \pm 3.1	11 \pm 1.0	14 \pm 1.3
Trial summary		Negative	Negative	Negative	Negative	Negative	Negative
Positive control		248 \pm 13.6	458 \pm 19.8	322 \pm 52.9	421 \pm 16.5	332 \pm 24.6	392 \pm 23.1
TA1537	0	8 \pm 1.2	8 \pm 2.6	4 \pm 1.5	11 \pm 0.9	6 \pm 2.2	12 \pm 2.2
	100	3 \pm 1.3	7 \pm 0.9	5 \pm 0.9	13 \pm 2.6	6 \pm 0.7	4 \pm 1.5
	333.3	4 \pm 0.7	7 \pm 1.2	4 \pm 0.7	12 \pm 3.2	5 \pm 0.6	4 \pm 1.5
	1,000	3 \pm 1.5	8 \pm 1.0	2 \pm 0.0	13 \pm 2.6	6 \pm 1.0	5 \pm 0.3
	3,333.3	1 \pm 1.0	9 \pm 1.7	5 \pm 1.8	15 \pm 2.1	6 \pm 0.9	3 \pm 0.6
	10,000	1 \pm 0.7	7 \pm 3.0	6 \pm 1.2	12 \pm 1.9	3 \pm 0.7	2 \pm 0.6
Trial summary		Negative	Negative	Negative	Negative	Negative	Negative
Positive control		530 \pm 132.9	431 \pm 20.9	152 \pm 22.0	510 \pm 10.7	298 \pm 20.9	221 \pm 31.0
TA98	0	26 \pm 4.4	28 \pm 1.5	24 \pm 3.5	40 \pm 1.9	21 \pm 2.6	48 \pm 4.3
	100	19 \pm 0.3	37 \pm 0.3	28 \pm 1.5	43 \pm 6.2	33 \pm 4.2	48 \pm 3.6
	333.3	17 \pm 4.9	34 \pm 4.3	32 \pm 4.4	33 \pm 5.6	25 \pm 5.8	43 \pm 2.0
	1,000	16 \pm 2.6	31 \pm 2.8	27 \pm 1.8	44 \pm 1.3	30 \pm 4.7	47 \pm 4.5
	3,333.3	21 \pm 2.6	25 \pm 2.6	33 \pm 2.9	41 \pm 0.9	26 \pm 5.5	37 \pm 3.1
	10,000	16 \pm 1.5	30 \pm 5.2	26 \pm 2.7	36 \pm 5.7	26 \pm 0.9	39 \pm 1.2
Trial summary		Negative	Negative	Negative	Negative	Negative	Negative
Positive control		837 \pm 116.2	777 \pm 23.2	1,733 \pm 92.8	1,598 \pm 76.2	458 \pm 13.6	511 \pm 35.6

^a The study was performed at SRI International. The detailed protocol and these data are presented in Mortelmans *et al.* (1986).

^b Revertants are presented as mean \pm standard error from three plates.

^c Slight toxicity

^d The positive controls in the absence of metabolic activation were sodium azide (TA100 and TA1535), 9-aminoacridine (TA1537), and 4-nitro-*o*-phenylenediamine (TA98). The positive control for metabolic activation with all strains was 2-aminoanthracene.

TABLE E2
Induction of Sister Chromatid Exchanges in Chinese Hamster Ovary Cells by Nitromethane^a

Compound	Dose ($\mu\text{g/mL}$)	Total Cells	No. of Chromo- somes	No. of SCEs	SCEs/ Chromo- some	SCEs/ Cell	Hrs in BrdU	Relative Change of SCEs/ Chromosome ^b (%)
-S9								
Summary: Negative								
Distilled water		50	1,048	349	0.33	7.0	26.0	
Mitomycin-C	0.001	50	1,050	534	0.50	10.7	26.0	52.72
	0.004	10	209	186	0.88	18.6	26.0	167.24
Nitromethane	497	50	1,049	374	0.35	7.5	26.0	7.06
	1,655	50	1,049	394	0.37	7.9	26.0	12.79
	4,965	50	1,052	411	0.39	8.2	26.0	17.32
P=0.010 ^c								
+S9								
Summary: Negative								
Distilled water		50	1,053	428	0.40	8.6	26.0	
Cyclophosphamide	0.125	50	1,051	647	0.61	12.9	26.0	51.46
	0.500	10	210	241	1.14	24.1	26.0	182.35
Nitromethane	497	50	1,050	407	0.38	8.1	26.0	-4.64
	1,655	50	1,052	383	0.36	7.7	26.0	-10.43
	4,965	50	1,051	381	0.36	7.6	26.0	-10.81
P=0.967								

^a The study was performed at SITEK Research Laboratories. A detailed description of the protocol is presented in Galloway *et al.* (1987).
 SCE=sister chromatid exchange; BrdU=bromodeoxyuridine.

^b SCEs/chromosome in treated cells versus SCEs/chromosome in solvent control cells

^c Significance of SCEs/chromosome tested by the linear regression trend test versus log of the dose

TABLE E3
Induction of Chromosomal Aberrations in Chinese Hamster Ovary Cells by Nitromethane^a

-S9					+S9				
Dose ($\mu\text{g/mL}$)	Total Cells	No. of Abs	Abs/ Cell	Cells with Abs (%)	Dose ($\mu\text{g/mL}$)	Total Cells	No. of Abs	Abs/ Cell	Cells with Abs (%)
Harvest time: 13.5 hours Summary: Negative					Harvest time: 13.5 hours Summary: Negative				
Distilled water					Distilled water				
	200	6	0.03	3.0		200	3	0.02	1.5
Mitomycin-C					Cyclophosphamide				
0.4	25	10	0.40	32.0	20	25	51	2.04	68.0
Nitromethane					Nitromethane				
1,077	200	0	0.00	0.0	1,077	200	5	0.03	2.5
2,316	200	3	0.02	1.5	2,316	200	2	0.01	1.0
4,980	200	3	0.02	1.5	4,980	200	6	0.03	3.0
$P=0.782^b$					$P=0.249$				

^a The study was performed at SITEK Research Laboratories. The detailed protocol is presented in Galloway *et al.* (1987).
 Abs=aberrations.

^b Significance of percent cells with aberrations tested by the linear regression trend test versus log of the dose

TABLE E4
Frequency of Micronuclei in Peripheral Blood Erythrocytes of Mice Following Treatment with Nitromethane by Inhalation for 13 Weeks^a

Dose (ppm)	Total NCEs	Micronucleated NCEs	Micronucleated NCEs/ Total NCEs ^b (%)	P Value ^c
Male				
0	103,800	54	0.052 ± 0.0076	
94	106,300	85	0.080 ± 0.0078	0.006
188	105,175	64	0.061 ± 0.0064	0.198
375	106,925	72	0.067 ± 0.0111	0.075
750	106,075	68	0.064 ± 0.0076	0.125
1,500	105,850	74	0.070 ± 0.0066	0.049
Trend test			P=0.273 ^d	
Female				
0	106,400	58	0.055 ± 0.0071	
94	106,625	39	0.037 ± 0.0062	0.974
188	106,700	43	0.040 ± 0.0068	0.934
375	104,750	41	0.039 ± 0.0031	0.949
750	106,200	58	0.055 ± 0.0056	0.496
1,500	108,075	53	0.049 ± 0.0064	0.711
Trend test			P=0.186	

^a The study was performed at SRI International. The detailed protocol is presented in MacGregor *et al.* (1990); NCE=normochromatic erythrocyte.

^b Mean ± standard error

^c Pairwise comparisons; significant at P<0.005

^d Significance of micronucleated NCEs/total NCEs tested by a one-tailed trend test; significant at P<0.025

APPENDIX F
ORGAN WEIGHTS AND
ORGAN-WEIGHT-TO-BODY-WEIGHT RATIOS

TABLE F1	Organ Weights and Organ-Weight-to-Body-Weight Ratios for Rats in the 16-Day Inhalation Study of Nitromethane	236
TABLE F2	Organ Weights and Organ-Weight-to-Body-Weight Ratios for Rats in the 13-Week Inhalation Study of Nitromethane	237
TABLE F3	Organ Weights and Organ-Weight-to-Body-Weight Ratios for Mice in the 16-Day Inhalation Study of Nitromethane	238
TABLE F4	Organ Weights and Organ-Weight-to-Body-Weight Ratios for Mice in the 13-Week Inhalation Study of Nitromethane	239

TABLE F1
Organ Weights and Organ-Weight-to-Body-Weight Ratios for Rats in the 16-Day Inhalation Study of Nitromethane^a

	0 ppm	94 ppm	188 ppm	375 ppm	750 ppm	1,500 ppm
n	5	5	5	5	5	5
Male						
Necropsy body wt	218 ± 3	225 ± 5	223 ± 6	215 ± 7	206 ± 4	192 ± 4**
Heart						
Absolute	0.700 ± 0.018	0.710 ± 0.016	0.706 ± 0.014	0.680 ± 0.021	0.640 ± 0.017*	0.650 ± 0.016*
Relative	3.21 ± 0.05	3.16 ± 0.05	3.17 ± 0.09	3.17 ± 0.03	3.10 ± 0.02	3.38 ± 0.04
R. Kidney						
Absolute	0.852 ± 0.014	0.878 ± 0.011	0.904 ± 0.029	0.870 ± 0.037	0.854 ± 0.016	0.880 ± 0.022
Relative	3.91 ± 0.02	3.91 ± 0.08	4.05 ± 0.05	4.05 ± 0.07	4.14 ± 0.02*	4.58 ± 0.08**
Liver						
Absolute	8.922 ± 0.201	9.950 ± 0.250	9.794 ± 0.303	9.988 ± 0.393	9.028 ± 0.144	9.322 ± 0.346
Relative	40.98 ± 0.55	44.29 ± 0.71**	43.87 ± 0.66**	46.50 ± 0.68**	43.84 ± 0.63**	48.49 ± 0.99**
Lung						
Absolute	1.214 ± 0.025	1.402 ± 0.098	1.244 ± 0.034	1.844 ± 0.017**	1.192 ± 0.027	1.196 ± 0.070
Relative	5.58 ± 0.10	6.22 ± 0.34	5.57 ± 0.06	8.63 ± 0.30**	5.79 ± 0.11	6.22 ± 0.32
R. Testis						
Absolute	1.242 ± 0.032	1.279 ± 0.041	1.220 ± 0.039	1.227 ± 0.020	1.238 ± 0.025	1.203 ± 0.034
Relative	5.71 ± 0.15	5.70 ± 0.17	5.46 ± 0.06	5.73 ± 0.15	6.01 ± 0.09	6.27 ± 0.20*
Thymus						
Absolute	0.369 ± 0.025	0.382 ± 0.011	0.363 ± 0.024	0.349 ± 0.020	0.340 ± 0.010	0.284 ± 0.014**
Relative	1.70 ± 0.12	1.70 ± 0.06	1.62 ± 0.10	1.63 ± 0.08	1.65 ± 0.06	1.48 ± 0.04
Thyroid Gland						
Absolute	0.018 ± 0.001	0.018 ± 0.002	0.016 ± 0.001	0.018 ± 0.001	0.019 ± 0.001	0.020 ± 0.001
Relative	0.08 ± 0.00	0.08 ± 0.01	0.07 ± 0.00	0.08 ± 0.00	0.09 ± 0.01	0.10 ± 0.00*
Female						
Necropsy body wt	146 ± 2	148 ± 3	147 ± 2	146 ± 2	143 ± 2	137 ± 3
Heart						
Absolute	0.498 ± 0.012	0.520 ± 0.012	0.502 ± 0.014	0.512 ± 0.009	0.502 ± 0.009	0.528 ± 0.011
Relative	3.42 ± 0.06	3.51 ± 0.08	3.41 ± 0.08	3.50 ± 0.03	3.50 ± 0.04	3.86 ± 0.05**
R. Kidney						
Absolute	0.612 ± 0.022	0.616 ± 0.019	0.634 ± 0.013	0.614 ± 0.007	0.636 ± 0.007	0.660 ± 0.009
Relative	4.20 ± 0.13	4.15 ± 0.05	4.31 ± 0.08	4.19 ± 0.04	4.44 ± 0.06	4.82 ± 0.10**
Liver						
Absolute	5.240 ± 0.182	5.472 ± 0.193	5.578 ± 0.187	5.750 ± 0.160*	5.832 ± 0.067*	6.204 ± 0.118**
Relative	35.95 ± 0.86	36.87 ± 0.62	37.88 ± 0.82	39.28 ± 1.09**	40.72 ± 0.22**	45.30 ± 0.53**
Lung						
Absolute	0.968 ± 0.058	0.950 ± 0.046	1.010 ± 0.025	0.962 ± 0.020	0.906 ± 0.011	0.928 ± 0.042
Relative	6.64 ± 0.34	6.40 ± 0.23	6.87 ± 0.14	6.57 ± 0.11	6.33 ± 0.13	6.77 ± 0.23
Thymus						
Absolute	0.281 ± 0.008	0.317 ± 0.011	0.321 ± 0.012	0.318 ± 0.008	0.313 ± 0.015	0.286 ± 0.014
Relative	1.93 ± 0.06	2.15 ± 0.09	2.18 ± 0.06	2.17 ± 0.06	2.19 ± 0.12	2.10 ± 0.13
Thyroid Gland						
Absolute	0.013 ± 0.001	0.016 ± 0.001	0.014 ± 0.002	0.014 ± 0.001	0.015 ± 0.001	0.016 ± 0.001
Relative	0.09 ± 0.01	0.11 ± 0.00	0.10 ± 0.01	0.09 ± 0.00	0.11 ± 0.01	0.12 ± 0.01

* Significantly different ($P \leq 0.05$) from the control group by Williams' or Dunnett's test

** $P \leq 0.01$

^a Organ weights and body weights are given in grams; organ-weight-to-body-weight ratios are given as mg organ weight/g body weight (mean ± standard error).

TABLE F2
Organ Weights and Organ-Weight-to-Body-Weight Ratios for Rats in the 13-Week Inhalation Study of Nitromethane^a

	0 ppm	94 ppm	188 ppm	375 ppm	750 ppm	1,500 ppm
n	10	10	10	10	10	10
Male						
Necropsy body wt	338 ± 7	328 ± 7	346 ± 4	341 ± 4	331 ± 4	299 ± 11**
Heart						
Absolute	0.941 ± 0.020	0.900 ± 0.023	0.943 ± 0.015	0.936 ± 0.012	0.952 ± 0.013	0.913 ± 0.025
Relative	2.78 ± 0.03	2.74 ± 0.03	2.72 ± 0.03	2.75 ± 0.03	2.88 ± 0.02	3.07 ± 0.06**
R. Kidney						
Absolute	1.098 ± 0.038	1.040 ± 0.024	1.130 ± 0.024	1.114 ± 0.018	1.103 ± 0.020	1.094 ± 0.031
Relative	3.24 ± 0.06	3.17 ± 0.05	3.27 ± 0.07	3.27 ± 0.05	3.33 ± 0.05	3.68 ± 0.09**
Liver						
Absolute	11.518 ± 0.403	10.881 ± 0.462	11.898 ± 0.306	11.984 ± 0.113	12.010 ± 0.433	10.334 ± 0.454
Relative	33.99 ± 0.66	33.05 ± 0.76	34.34 ± 0.65	35.23 ± 0.55	36.23 ± 1.08	34.52 ± 0.42
Lung						
Absolute	1.708 ± 0.053	1.758 ± 0.063	1.859 ± 0.057	1.667 ± 0.044	1.631 ± 0.035	1.533 ± 0.061*
Relative	5.05 ± 0.11	5.36 ± 0.16	5.38 ± 0.17	4.89 ± 0.09	4.93 ± 0.09	5.13 ± 0.08
R. Testis						
Absolute	1.358 ± 0.031	1.293 ± 0.027	1.333 ± 0.020	1.326 ± 0.019	1.265 ± 0.037	1.245 ± 0.028*
Relative	4.01 ± 0.05	3.95 ± 0.06	3.85 ± 0.05	3.89 ± 0.04	3.82 ± 0.10	4.21 ± 0.16
Thymus						
Absolute	0.345 ± 0.013	0.331 ± 0.016	0.351 ± 0.012	0.340 ± 0.018	0.323 ± 0.016	0.278 ± 0.011**
Relative	1.02 ± 0.03	1.00 ± 0.03	1.01 ± 0.03	1.00 ± 0.05	0.98 ± 0.05	0.93 ± 0.03
Thyroid Gland						
Absolute	0.020 ± 0.001	0.018 ± 0.001	0.022 ± 0.002	0.019 ± 0.002	0.020 ± 0.001	0.025 ± 0.001 ^b
Relative	0.06 ± 0.00	0.05 ± 0.00	0.06 ± 0.01	0.05 ± 0.00	0.06 ± 0.00	0.08 ± 0.01** ^b
Female						
Necropsy body wt	188 ± 5	198 ± 3	199 ± 3	200 ± 5	195 ± 4	178 ± 3
Heart						
Absolute	0.583 ± 0.015	0.613 ± 0.007	0.627 ± 0.013	0.622 ± 0.017	0.614 ± 0.010	0.614 ± 0.012
Relative	3.11 ± 0.04	3.10 ± 0.04	3.15 ± 0.04	3.12 ± 0.05	3.16 ± 0.04	3.45 ± 0.05**
R. Kidney						
Absolute	0.619 ± 0.016	0.655 ± 0.011	0.642 ± 0.017	0.659 ± 0.017	0.668 ± 0.013	0.643 ± 0.010
Relative	3.30 ± 0.05	3.31 ± 0.04	3.22 ± 0.06	3.31 ± 0.07	3.44 ± 0.06	3.62 ± 0.08**
Liver						
Absolute	6.342 ± 0.205	6.773 ± 0.095	7.028 ± 0.258	7.042 ± 0.175*	6.707 ± 0.172	6.623 ± 0.193
Relative	33.74 ± 0.54	34.25 ± 0.50	35.30 ± 1.07	35.36 ± 0.62	34.50 ± 0.60	37.15 ± 0.62**
Lung						
Absolute	1.051 ± 0.025	1.102 ± 0.018	1.052 ± 0.056	1.092 ± 0.023	1.098 ± 0.018	1.049 ± 0.024
Relative	5.60 ± 0.07	5.58 ± 0.12	5.29 ± 0.27	5.49 ± 0.09	5.66 ± 0.10	5.89 ± 0.08
Thymus						
Absolute	0.242 ± 0.008	0.263 ± 0.008	0.280 ± 0.011*	0.256 ± 0.008	0.253 ± 0.009	0.239 ± 0.009
Relative	1.29 ± 0.03	1.33 ± 0.03	1.41 ± 0.05	1.28 ± 0.04	1.30 ± 0.04	1.34 ± 0.05
Thyroid Gland						
Absolute	0.018 ± 0.001	0.016 ± 0.002	0.021 ± 0.002	0.017 ± 0.001	0.018 ± 0.001	0.018 ± 0.001
Relative	0.10 ± 0.01	0.08 ± 0.01	0.10 ± 0.01	0.09 ± 0.01	0.09 ± 0.00	0.10 ± 0.01

* Significantly different ($P \leq 0.05$) from the control group by Williams' or Dunnett's test

** $P \leq 0.01$

^a Organ weights and body weights are given in grams; organ-weight-to-body-weight ratios are given as mg organ weight/g body weight (mean ± standard error).

^b n=9

TABLE F3
Organ Weights and Organ-Weight-to-Body-Weight Ratios for Mice in the 16-Day Inhalation Study of Nitromethane^a

	0 ppm	94 ppm	188 ppm	375 ppm	750 ppm	1,500 ppm
n	5	5	5	5	5	5
Male						
Necropsy body wt	27.4 ± 0.6	29.0 ± 1.0	28.9 ± 0.6	27.7 ± 0.9	29.2 ± 0.7	28.6 ± 0.2
Heart						
Absolute	0.136 ± 0.009	0.134 ± 0.006	0.138 ± 0.006	0.128 ± 0.007	0.136 ± 0.007	0.128 ± 0.006
Relative	4.94 ± 0.22	4.62 ± 0.08	4.77 ± 0.14	4.60 ± 0.13	4.65 ± 0.16	4.47 ± 0.19
R. Kidney						
Absolute	0.286 ± 0.012	0.286 ± 0.013	0.278 ± 0.007	0.282 ± 0.012	0.284 ± 0.007	0.278 ± 0.006
Relative	10.42 ± 0.26	9.85 ± 0.20	9.62 ± 0.28*	10.16 ± 0.15	9.73 ± 0.11	9.72 ± 0.19
Liver						
Absolute	1.376 ± 0.044	1.538 ± 0.083	1.552 ± 0.045	1.526 ± 0.078	1.752 ± 0.081**	1.680 ± 0.053**
Relative	50.15 ± 0.67	52.99 ± 2.14	53.63 ± 0.53	54.96 ± 1.53*	59.93 ± 1.38**	58.72 ± 1.61**
Lung						
Absolute	0.200 ± 0.004	0.212 ± 0.012	0.202 ± 0.006	0.200 ± 0.005	0.210 ± 0.005	0.204 ± 0.005
Relative	7.31 ± 0.27	7.29 ± 0.20	7.00 ± 0.25	7.24 ± 0.27	7.20 ± 0.07	7.13 ± 0.15
R. Testis						
Absolute	0.113 ± 0.003	0.113 ± 0.003	0.112 ± 0.003	0.110 ± 0.003	0.112 ± 0.001	0.113 ± 0.001
Relative	4.12 ± 0.11	3.92 ± 0.13	3.89 ± 0.16	3.98 ± 0.16	3.83 ± 0.04	3.94 ± 0.04
Thymus						
Absolute	0.047 ± 0.003	0.046 ± 0.004	0.044 ± 0.003	0.037 ± 0.003	0.047 ± 0.004	0.053 ± 0.002
Relative	1.73 ± 0.11	1.60 ± 0.13	1.51 ± 0.11	1.35 ± 0.10	1.64 ± 0.17	1.84 ± 0.08
Female						
Necropsy body wt	23.3 ± 0.2	23.7 ± 0.3	23.6 ± 0.3	23.8 ± 0.4	24.7 ± 0.4*	24.0 ± 0.4
Heart						
Absolute	0.112 ± 0.002	0.118 ± 0.002	0.114 ± 0.002	0.112 ± 0.002	0.112 ± 0.004	0.114 ± 0.005
Relative	4.81 ± 0.07	4.98 ± 0.08	4.84 ± 0.08	4.71 ± 0.07	4.55 ± 0.22	4.75 ± 0.16
R. Kidney						
Absolute	0.194 ± 0.002	0.196 ± 0.002	0.198 ± 0.006	0.192 ± 0.004	0.196 ± 0.002	0.202 ± 0.007
Relative	8.33 ± 0.07	8.27 ± 0.12	8.40 ± 0.17	8.07 ± 0.11	7.95 ± 0.19	8.42 ± 0.26
Liver						
Absolute	1.146 ± 0.020	1.256 ± 0.035*	1.338 ± 0.037**	1.364 ± 0.047**	1.442 ± 0.020**	1.410 ± 0.044**
Relative	49.24 ± 0.96	53.00 ± 1.40*	56.77 ± 1.15**	57.28 ± 1.56**	58.44 ± 1.18**	58.70 ± 0.90**
Lung						
Absolute	0.198 ± 0.007	0.190 ± 0.003	0.196 ± 0.007	0.200 ± 0.007	0.200 ± 0.008	0.190 ± 0.004
Relative	8.50 ± 0.30	8.02 ± 0.08	8.31 ± 0.22	8.42 ± 0.40	8.10 ± 0.34	7.93 ± 0.22
Thymus						
Absolute	0.065 ± 0.002	0.064 ± 0.002	0.072 ± 0.001	0.064 ± 0.004	0.063 ± 0.003	0.068 ± 0.003
Relative	2.80 ± 0.11	2.69 ± 0.07	3.06 ± 0.07	2.68 ± 0.13	2.57 ± 0.13	2.83 ± 0.13

* Significantly different ($P \leq 0.05$) from the control group by Williams' or Dunnett's test

** $P \leq 0.01$

^a Organ weights and body weights are given in grams; organ-weight-to-body-weight ratios are given as mg organ weight/g body weight (mean ± standard error).

TABLE F4
Organ Weights and Organ-Weight-to-Body-Weight Ratios for Mice in the 13-Week Inhalation Study of Nitromethane^a

	0 ppm	94 ppm	188 ppm	375 ppm	750 ppm	1,500 ppm
n	10	10	10	10	10	10
Male						
Necropsy body wt	36.1 ± 0.5	35.9 ± 0.5	35.5 ± 0.8	36.3 ± 0.6	35.2 ± 0.4	34.7 ± 0.5
Heart						
Absolute	0.148 ± 0.003	0.153 ± 0.003	0.147 ± 0.002	0.151 ± 0.002	0.148 ± 0.003	0.149 ± 0.002
Relative	4.10 ± 0.07	4.26 ± 0.06	4.16 ± 0.07	4.17 ± 0.09	4.20 ± 0.10	4.30 ± 0.06
R. Kidney						
Absolute	0.294 ± 0.009	0.329 ± 0.006**	0.322 ± 0.005*	0.332 ± 0.007**	0.339 ± 0.007**	0.315 ± 0.008
Relative	8.15 ± 0.20	9.15 ± 0.11**	9.10 ± 0.15**	9.15 ± 0.20**	9.63 ± 0.20**	9.08 ± 0.18**
Liver						
Absolute	1.633 ± 0.040	1.700 ± 0.023	1.678 ± 0.031	1.731 ± 0.027	1.789 ± 0.029*	1.724 ± 0.053
Relative	45.27 ± 0.89	47.32 ± 0.38	47.39 ± 0.78	47.70 ± 0.60*	50.79 ± 0.72**	49.62 ± 0.99**
Lung						
Absolute	0.240 ± 0.008	0.251 ± 0.007	0.234 ± 0.007	0.241 ± 0.005	0.237 ± 0.004	0.234 ± 0.006
Relative	6.65 ± 0.20	6.98 ± 0.13	6.59 ± 0.10	6.65 ± 0.14	6.73 ± 0.11	6.75 ± 0.17
R. Testis						
Absolute	0.126 ± 0.003	0.123 ± 0.002	0.124 ± 0.004	0.127 ± 0.003	0.127 ± 0.003	0.126 ± 0.003
Relative	3.51 ± 0.08	3.43 ± 0.09	3.51 ± 0.10	3.50 ± 0.09	3.61 ± 0.09	3.63 ± 0.06
Thymus						
Absolute	0.042 ± 0.002	0.042 ± 0.002	0.041 ± 0.002	0.045 ± 0.004	0.041 ± 0.003	0.039 ± 0.002
Relative	1.18 ± 0.05	1.17 ± 0.07	1.17 ± 0.07	1.24 ± 0.09	1.16 ± 0.09	1.11 ± 0.06
Female						
Necropsy body wt	31.1 ± 0.7	31.5 ± 0.7	32.8 ± 0.7	34.2 ± 0.8**	31.5 ± 0.5	30.4 ± 0.5
Heart						
Absolute	0.132 ± 0.003	0.129 ± 0.002	0.132 ± 0.002	0.129 ± 0.006	0.130 ± 0.003	0.134 ± 0.002
Relative	4.25 ± 0.09	4.11 ± 0.10	4.03 ± 0.05	3.77 ± 0.16**	4.12 ± 0.07	4.41 ± 0.07
R. Kidney						
Absolute	0.210 ± 0.007	0.221 ± 0.005	0.228 ± 0.005*	0.232 ± 0.005*	0.231 ± 0.006*	0.230 ± 0.006*
Relative	6.75 ± 0.18	7.03 ± 0.15	6.97 ± 0.15	6.80 ± 0.17	7.33 ± 0.21*	7.57 ± 0.15**
Liver						
Absolute	1.536 ± 0.033	1.590 ± 0.030	1.604 ± 0.044	1.639 ± 0.037	1.563 ± 0.041	1.575 ± 0.050
Relative	49.49 ± 0.99	50.64 ± 1.15	48.89 ± 0.72	47.97 ± 0.95	49.52 ± 0.76	51.77 ± 1.25
Lung						
Absolute	0.233 ± 0.005	0.239 ± 0.004	0.248 ± 0.013	0.244 ± 0.003	0.245 ± 0.015	0.227 ± 0.005
Relative	7.50 ± 0.13	7.62 ± 0.19	7.55 ± 0.33	7.15 ± 0.11	7.76 ± 0.44	7.47 ± 0.14
Thymus						
Absolute	0.055 ± 0.002	0.053 ± 0.004	0.063 ± 0.002	0.060 ± 0.003	0.057 ± 0.002	0.061 ± 0.002
Relative	1.78 ± 0.09	1.69 ± 0.12	1.91 ± 0.05	1.75 ± 0.06	1.81 ± 0.08	2.00 ± 0.08

* Significantly different ($P \leq 0.05$) from the control group by Williams' or Dunnett's test

** $P \leq 0.01$

^a Organ weights and body weights are given in grams; organ-weight-to-body-weight ratios are given as mg organ weight/g body weight (mean ± standard error).

APPENDIX G
HEMATOLOGY
AND CLINICAL CHEMISTRY RESULTS

TABLE G1	Hematology and Clinical Chemistry Data for Rats in the 13-Week Inhalation Study of Nitromethane	242
----------	--	-----

TABLE G1
Hematology and Clinical Chemistry Data for Rats in the 13-Week Inhalation Study of Nitromethane^a

	0 ppm	94 ppm	188 ppm	375 ppm	750 ppm	1,500 ppm
Male						
Hematology						
n						
Day 3	10	10	10	10	10	10
Day 23	6	8	9	10	10	10
Week 13	10	10	10	10	10	10
Hematocrit (%)						
Day 3	36.7 ± 0.5	36.3 ± 0.3	35.2 ± 0.2*	33.1 ± 0.3**	31.7 ± 0.2**	32.3 ± 0.2**
Day 23	40.7 ± 0.3	43.2 ± 0.9	40.4 ± 0.4	37.6 ± 0.4*	34.0 ± 0.4**	30.3 ± 0.4**
Week 13	46.3 ± 0.1	46.6 ± 0.4	46.1 ± 0.4	44.6 ± 0.3**	42.5 ± 0.4**	39.2 ± 0.4**
Hemoglobin (g/dL)						
Day 3	13.9 ± 0.2	13.5 ± 0.1	13.3 ± 0.1*	12.6 ± 0.1**	12.2 ± 0.1**	12.4 ± 0.1**
Day 23	15.3 ± 0.2	16.1 ± 0.3	15.0 ± 0.1	14.3 ± 0.1*	13.2 ± 0.1**	11.9 ± 0.1**
Week 13	15.3 ± 0.1	15.4 ± 0.1	15.2 ± 0.1	14.8 ± 0.1**	14.3 ± 0.1**	13.4 ± 0.2**
Erythrocytes (10⁶/μL)						
Day 3	7.75 ± 0.10	7.58 ± 0.08	7.38 ± 0.08**	7.16 ± 0.07**	6.97 ± 0.04**	6.94 ± 0.06**
Day 23	8.74 ± 0.06	9.37 ± 0.18*	9.00 ± 0.07	9.36 ± 0.09*	9.10 ± 0.09	7.77 ± 0.11
Week 13	9.12 ± 0.03	9.43 ± 0.06**	9.53 ± 0.08**	9.72 ± 0.08**	10.10 ± 0.09**	9.41 ± 0.11**
Nucleated erythrocytes (10³/μL)						
Day 3	0.11 ± 0.03	0.17 ± 0.05	0.19 ± 0.03	0.08 ± 0.03	0.05 ± 0.02	0.06 ± 0.02
Day 23	0.01 ± 0.01	0.03 ± 0.02	0.08 ± 0.02	0.05 ± 0.02	0.04 ± 0.02	0.12 ± 0.03*
Week 13	0.03 ± 0.02	0.04 ± 0.02	0.03 ± 0.03	0.11 ± 0.03	0.08 ± 0.03	0.27 ± 0.07**
Mean cell volume (fL)						
Day 3	47.2 ± 0.3	47.9 ± 0.3	47.7 ± 0.4	46.2 ± 0.1*	45.5 ± 0.2**	46.3 ± 0.2**
Day 23	46.5 ± 0.3	46.0 ± 0.2	45.0 ± 0.4**	40.2 ± 0.3**	37.5 ± 0.2**	39.1 ± 0.2**
Week 13	50.7 ± 0.2	49.3 ± 0.2**	48.4 ± 0.2**	45.8 ± 0.4**	42.0 ± 0.6**	41.6 ± 0.3**
Mean cell hemoglobin (pg)						
Day 3	17.9 ± 0.1	17.8 ± 0.1	18.1 ± 0.1	17.6 ± 0.0*	17.5 ± 0.1*	17.9 ± 0.1
Day 23	17.5 ± 0.2	17.2 ± 0.1	16.7 ± 0.1**	15.3 ± 0.1**	14.5 ± 0.0**	15.3 ± 0.1**
Week 13	16.8 ± 0.0	16.3 ± 0.1**	16.0 ± 0.0**	15.2 ± 0.1**	14.1 ± 0.2**	14.3 ± 0.1**
Mean cell hemoglobin concentration (g/dL)						
Day 3	37.8 ± 0.2	37.3 ± 0.1	37.8 ± 0.1	38.1 ± 0.1	38.4 ± 0.2*	38.6 ± 0.1**
Day 23	37.5 ± 0.2	37.3 ± 0.1	37.3 ± 0.2	38.2 ± 0.3	38.8 ± 0.2*	39.3 ± 0.2**
Week 13	33.0 ± 0.1	33.0 ± 0.1	33.0 ± 0.1	33.2 ± 0.1	33.6 ± 0.1**	34.3 ± 0.3**
Platelets (10³/μL)						
Day 3	663.6 ± 15.5	741.9 ± 13.8**	708.2 ± 13.5**	732.7 ± 17.8**	781.2 ± 10.5**	870.6 ± 16.3**
Day 23	643.8 ± 44.1	663.4 ± 8.8	675.0 ± 16.0	704.8 ± 19.2	878.4 ± 22.5**	1,325.2 ± 24.0**
Week 13	538.3 ± 7.5	527.8 ± 16.7	539.2 ± 5.7	578.7 ± 6.1**	625.0 ± 9.2**	817.4 ± 32.9**
Leukocytes (10³/μL)						
Day 3	7.22 ± 0.24	8.24 ± 0.28	7.96 ± 0.46	7.22 ± 0.35	7.70 ± 0.31	7.17 ± 0.32
Day 23	5.46 ± 0.61	7.19 ± 0.45	6.91 ± 0.44	5.45 ± 0.48	5.87 ± 0.52	5.46 ± 0.36
Week 13	8.65 ± 0.29	8.71 ± 0.46	8.20 ± 0.34	8.42 ± 0.46	8.79 ± 0.37	9.84 ± 0.26
Segmented neutrophils (10³/μL)						
Day 3	1.10 ± 0.10	0.90 ± 0.07	0.94 ± 0.11	0.96 ± 0.08	0.82 ± 0.12	0.90 ± 0.15
Day 23	0.84 ± 0.05	0.74 ± 0.09	0.84 ± 0.12	0.76 ± 0.10	0.52 ± 0.10	0.54 ± 0.08
Week 13	1.90 ± 0.12	1.63 ± 0.21	1.96 ± 0.14	1.57 ± 0.17	1.29 ± 0.21	1.64 ± 0.18
Lymphocytes (10³/μL)						
Day 3	5.82 ± 0.27	6.90 ± 0.28	6.47 ± 0.46	6.04 ± 0.30	6.53 ± 0.25	6.03 ± 0.23
Day 23	4.45 ± 0.56	6.19 ± 0.41	5.73 ± 0.36	4.55 ± 0.39	5.15 ± 0.44	4.78 ± 0.32
Week 13	6.25 ± 0.28	6.62 ± 0.34	5.76 ± 0.34	6.37 ± 0.39	6.96 ± 0.45	7.82 ± 0.36**

TABLE G1
Hematology and Clinical Chemistry Data for Rats in the 13-Week Inhalation Study of Nitromethane (continued)

	0 ppm	94 ppm	188 ppm	375 ppm	750 ppm	1,500 ppm
Male (continued)						
Hematology (continued)						
n						
Day 3	10	10	10	10	10	10
Day 23	6	8	9	10	10	10
Week 13	10	10	10	10	10	10
Monocytes ($10^3/\mu\text{L}$)						
Day 3	0.28 ± 0.04	0.39 ± 0.07	0.53 ± 0.11	0.21 ± 0.05	0.33 ± 0.06	0.23 ± 0.04
Day 23	0.16 ± 0.05	0.24 ± 0.07	0.31 ± 0.07	0.13 ± 0.05	0.19 ± 0.04	0.14 ± 0.03
Week 13	0.47 ± 0.08	0.43 ± 0.05	0.43 ± 0.07	0.43 ± 0.05	0.47 ± 0.09	0.35 ± 0.06
Eosinophils ($10^3/\mu\text{L}$)						
Day 3	0.02 ± 0.01	0.05 ± 0.02	0.02 ± 0.01	0.01 ± 0.01	0.02 ± 0.01	0.01 ± 0.01
Day 23	0.01 ± 0.01	0.04 ± 0.01	0.03 ± 0.01	0.00 ± 0.00	0.01 ± 0.01	0.00 ± 0.00
Week 13	0.02 ± 0.02	0.03 ± 0.01	0.04 ± 0.02	0.06 ± 0.03	0.07 ± 0.03	0.04 ± 0.02
Methemoglobin (g/dL)						
Day 3	0.16 ± 0.02 ^b	0.14 ± 0.02 ^b	0.19 ± 0.02 ^c	0.34 ± 0.02 ^{**}	0.21 ± 0.03 ^{*d}	0.22 ± 0.02 ^{*c}
Day 23	0.08 ± 0.01	0.06 ± 0.01	0.08 ± 0.01	0.16 ± 0.06	0.15 ± 0.01 [*]	0.28 ± 0.02 ^{**}
Week 13	0.15 ± 0.01	0.17 ± 0.02	0.17 ± 0.01 [*]	0.17 ± 0.01 [*]	0.21 ± 0.01 ^{**}	0.41 ± 0.09 ^{**}
Clinical Chemistry						
n						
Day 3	10	10	10	10	10	10
Day 23	6	8	9	10	10	9
Week 13	10	10	10	10	10	10
Urea nitrogen (mg/dL)						
Day 3	15.5 ± 0.5	17.0 ± 0.5	15.6 ± 0.5	15.7 ± 0.4	14.2 ± 0.3	12.9 ± 0.3 ^{**}
Day 23	13.8 ± 0.6	16.4 ± 0.8	14.4 ± 0.6	15.4 ± 0.5	12.5 ± 0.4	12.2 ± 0.5
Week 13	22.6 ± 0.7	23.0 ± 1.0	22.5 ± 0.6	23.1 ± 0.7	22.2 ± 0.7	19.4 ± 0.5 ^{**}
Creatinine (mg/dL)						
Day 3	0.62 ± 0.02 ^b	0.64 ± 0.02	0.61 ± 0.02	0.65 ± 0.02	0.78 ± 0.03 ^{**}	1.05 ± 0.03 ^{**}
Day 23	0.82 ± 0.02	0.76 ± 0.02	0.87 ± 0.02	0.82 ± 0.03	0.85 ± 0.03	0.94 ± 0.04
Week 13	0.84 ± 0.03	0.83 ± 0.03	0.82 ± 0.04	0.84 ± 0.03	0.78 ± 0.04	0.71 ± 0.04
Total protein (g/dL)						
Day 3	6.3 ± 0.0 ^b	6.3 ± 0.1	6.4 ± 0.1	6.6 ± 0.1	6.2 ± 0.1	6.4 ± 0.1
Day 23	7.3 ± 0.1	7.0 ± 0.1	7.1 ± 0.1	7.4 ± 0.2	7.0 ± 0.1 [*]	6.5 ± 0.1 ^{**}
Week 13	7.2 ± 0.1	7.2 ± 0.1	7.4 ± 0.1	7.3 ± 0.1	7.2 ± 0.1	6.8 ± 0.1
Albumin (g/dL)						
Day 3	4.1 ± 0.1 ^b	4.1 ± 0.1	4.3 ± 0.1	4.6 ± 0.1 ^{**}	4.3 ± 0.1	4.4 ± 0.1
Day 23	4.9 ± 0.1	4.9 ± 0.1	5.0 ± 0.1	4.9 ± 0.1	4.8 ± 0.0	4.5 ± 0.1 ^{**}
Week 13	4.5 ± 0.1	4.6 ± 0.1	4.6 ± 0.1	4.6 ± 0.1	4.6 ± 0.1	4.6 ± 0.1
Globulin (g/dL)						
Day 3	2.2 ± 0.1 ^b	2.2 ± 0.0	2.0 ± 0.1	2.0 ± 0.1 [*]	1.9 ± 0.0 ^{**}	2.0 ± 0.0 ^{**}
Day 23	2.4 ± 0.1	2.1 ± 0.1	2.0 ± 0.1 [*]	2.5 ± 0.1	2.2 ± 0.1	2.0 ± 0.1 [*]
Week 13	2.7 ± 0.1	2.5 ± 0.1	2.8 ± 0.1	2.7 ± 0.1	2.6 ± 0.1	2.2 ± 0.1 [*]

TABLE G1
Hematology and Clinical Chemistry Data for Rats in the 13-Week Inhalation Study of Nitromethane (continued)

	0 ppm	94 ppm	188 ppm	375 ppm	750 ppm	1,500 ppm
Male (continued)						
Clinical Chemistry (continued)						
n						
Day 3	10	10	10	10	10	10
Day 23	6	8	9	10	10	9
Week 13	10	10	10	10	10	10
Alanine aminotransferase (IU/L)						
Day 3	41 ± 3	41 ± 2	41 ± 1	34 ± 1*	32 ± 1**	31 ± 1**
Day 23	39 ± 2	42 ± 5	41 ± 2	41 ± 3	34 ± 1*	33 ± 1*
Week 13	57 ± 5	72 ± 6	73 ± 7	63 ± 3	60 ± 4	40 ± 1*
Alkaline phosphatase (IU/L)						
Day 3	883 ± 19	971 ± 25	995 ± 18	943 ± 16	811 ± 20	779 ± 22
Day 23	645 ± 25	631 ± 15	625 ± 11	667 ± 27	572 ± 16*	523 ± 20**
Week 13	359 ± 14	346 ± 12	334 ± 8	371 ± 19	365 ± 12	333 ± 12
Creatine kinase (IU/L)						
Day 3	526 ± 24 ^b	442 ± 14*	443 ± 33*	429 ± 22*	416 ± 86**	231 ± 13**
Day 23	255 ± 43	482 ± 74	512 ± 39 ^c	430 ± 85 ^b	244 ± 44	167 ± 14 ^c
Week 13	200 ± 25	214 ± 22	172 ± 19	177 ± 23	200 ± 28	122 ± 14
Sorbitol dehydrogenase (IU/L)						
Day 3	8 ± 1	9 ± 1	10 ± 0	10 ± 1*	8 ± 1	6 ± 0
Day 23	12 ± 1	13 ± 1	13 ± 1	12 ± 1	10 ± 1	9 ± 1*
Week 13	11 ± 1	13 ± 1	13 ± 1	13 ± 1	12 ± 1	8 ± 0
Bile acids (μmol/L)						
Day 3	11.8 ± 2.9 ^c	9.4 ± 0.8	7.8 ± 1.5 ^b	9.1 ± 1.6 ^c	8.2 ± 1.0	8.4 ± 1.0 ^b
Day 23	13.1 ± 4.5	9.6 ± 2.0	8.6 ± 2.1	10.6 ± 2.3 ^b	7.8 ± 2.5	3.6 ± 0.7** ^c
Week 13	7.0 ± 2.5	5.3 ± 0.6 ^b	8.7 ± 1.9 ^b	4.9 ± 0.4	4.5 ± 0.9 ^b	8.4 ± 2.3 ^b
Thyroid-stimulating hormone (ng/mL)						
Day 23	0.7 ± 0.2 ^e	0.5 ± 0.1 ^f	1.2 ± 0.2	1.5 ± 0.3 ^c	1.0 ± 0.2	0.7 ± 0.1
Week 13	3.7 ± 0.8	2.5 ± 0.4	4.1 ± 0.6	3.3 ± 0.5	3.3 ± 0.4	3.0 ± 0.5
Triiodothyronine (ng/dL)						
Day 23	116 ± 7 ^e	105 ± 5	105 ± 3	91 ± 4** ^c	95 ± 4*	92 ± 10*
Week 13	123 ± 8	134 ± 12	125 ± 6	138 ± 4	137 ± 8	134 ± 8
Thyroxine (μg/dL)						
Day 23	5.4 ± 0.2	5.2 ± 0.2	5.2 ± 0.2 ^c	4.4 ± 0.2* ^c	5.0 ± 0.2	4.4 ± 0.2**
Week 13	4.9 ± 0.3	5.2 ± 0.3	5.1 ± 0.2	5.3 ± 0.2	5.2 ± 0.1	5.9 ± 0.3**
Free thyroxine (ng/dL)						
Day 23	1.3 ± 0.1	1.2 ± 0.1 ^f	1.2 ± 0.1	0.9 ± 0.1** ^b	1.1 ± 0.1*	1.0 ± 0.1*
Week 13	1.4 ± 0.1	1.4 ± 0.1	1.2 ± 0.1	1.2 ± 0.1	1.3 ± 0.0	1.5 ± 0.1

TABLE G1
Hematology and Clinical Chemistry Data for Rats in the 13-Week Inhalation Study of Nitromethane (continued)

	0 ppm	94 ppm	188 ppm	375 ppm	750 ppm	1,500 ppm
Female						
Hematology						
n						
Day 3	10	10	10	10	10	10
Day 23	10	10	10	10	10	8
Week 13	10	10	10	10	10	10
Hematocrit (%)						
Day 3	38.9 ± 0.6	38.7 ± 0.3	38.1 ± 0.4	36.7 ± 0.3**	36.0 ± 0.3**	36.6 ± 0.4**
Day 23	42.6 ± 0.3	40.5 ± 0.9**	41.1 ± 0.5*	37.9 ± 0.4**	35.2 ± 0.3**	31.7 ± 0.2**
Week 13	46.8 ± 0.3	46.6 ± 0.4	44.7 ± 0.4**	44.4 ± 0.5**	40.7 ± 0.4**	37.8 ± 0.4**
Hemoglobin (g/dL)						
Day 3	14.9 ± 0.2	14.9 ± 0.1	14.6 ± 0.2	14.0 ± 0.1**	13.7 ± 0.1**	14.1 ± 0.2**
Day 23	16.2 ± 0.1	15.4 ± 0.3**	15.6 ± 0.2*	14.5 ± 0.1**	13.5 ± 0.1**	12.5 ± 0.1**
Week 13	16.0 ± 0.1	15.8 ± 0.1	15.3 ± 0.1**	15.3 ± 0.1**	14.1 ± 0.1**	13.4 ± 0.2**
Erythrocytes (10⁶/μL)						
Day 3	8.39 ± 0.15	8.42 ± 0.07	8.34 ± 0.11	8.10 ± 0.09	7.87 ± 0.07**	8.14 ± 0.11*
Day 23	9.03 ± 0.06	8.86 ± 0.18	9.35 ± 0.09	9.32 ± 0.09	9.14 ± 0.09	8.16 ± 0.06
Week 13	8.71 ± 0.05	8.91 ± 0.06	8.92 ± 0.09	9.42 ± 0.07**	9.24 ± 0.07**	8.51 ± 0.10
Nucleated erythrocytes (10³/μL)						
Day 3	0.07 ± 0.03	0.06 ± 0.03	0.08 ± 0.02	0.07 ± 0.03	0.04 ± 0.02	0.02 ± 0.02
Day 23	0.00 ± 0.00	0.03 ± 0.02	0.02 ± 0.02	0.03 ± 0.02	0.01 ± 0.01	0.05 ± 0.02*
Week 13	0.03 ± 0.01	0.07 ± 0.02	0.09 ± 0.04	0.06 ± 0.04	0.22 ± 0.09	0.30 ± 0.11**
Mean cell volume (fL)						
Day 3	46.5 ± 0.2	45.8 ± 0.2*	45.6 ± 0.3*	45.3 ± 0.2**	45.7 ± 0.2**	45.0 ± 0.2**
Day 23	47.0 ± 0.0	45.8 ± 0.2**	43.9 ± 0.2**	40.6 ± 0.2**	38.4 ± 0.2**	38.8 ± 0.2**
Week 13	53.9 ± 0.2	52.4 ± 0.2**	50.1 ± 0.3**	47.2 ± 0.2**	44.2 ± 0.5**	44.4 ± 0.4**
Mean cell hemoglobin (pg)						
Day 3	17.7 ± 0.1	17.7 ± 0.1	17.5 ± 0.1	17.3 ± 0.1**	17.4 ± 0.1**	17.3 ± 0.1**
Day 23	18.0 ± 0.1	17.4 ± 0.1**	16.7 ± 0.1**	15.6 ± 0.1**	14.8 ± 0.1**	15.3 ± 0.1**
Week 13	18.3 ± 0.1	17.7 ± 0.1**	17.1 ± 0.1**	16.2 ± 0.1**	15.3 ± 0.1**	15.7 ± 0.1**
Mean cell hemoglobin concentration (g/dL)						
Day 3	38.1 ± 0.1	38.4 ± 0.1	38.4 ± 0.1	38.1 ± 0.1	38.1 ± 0.1	38.6 ± 0.1**
Day 23	38.0 ± 0.2	38.1 ± 0.2	38.0 ± 0.2	38.2 ± 0.2	38.4 ± 0.2	39.5 ± 0.2**
Week 13	34.1 ± 0.2	33.9 ± 0.2	34.2 ± 0.2	34.4 ± 0.2	34.7 ± 0.2	35.4 ± 0.2**
Platelets (10³/μL)						
Day 3	669.7 ± 26.8	586.2 ± 15.3*	609.0 ± 26.4	657.9 ± 17.9	668.0 ± 15.8	624.6 ± 17.6
Day 23	649.2 ± 12.7	628.9 ± 14.4	637.2 ± 12.6	698.7 ± 14.0	811.9 ± 14.4**	1,179.0 ± 18.5**
Week 13	534.2 ± 7.7	560.6 ± 10.8	528.4 ± 10.2	608.8 ± 11.7**	669.9 ± 10.8**	765.0 ± 32.6**
Leukocytes (10³/μL)						
Day 3	9.26 ± 0.32	9.98 ± 0.32	10.43 ± 0.23*	9.78 ± 0.24	9.83 ± 0.24	8.02 ± 0.26
Day 23	6.35 ± 0.27	6.57 ± 0.43	6.20 ± 0.35	6.19 ± 0.25	5.90 ± 0.20	6.25 ± 0.50
Week 13	9.56 ± 0.67	7.99 ± 0.29	8.08 ± 0.51	10.28 ± 0.80	9.95 ± 0.73	10.60 ± 0.82
Segmented neutrophils (10³/μL)						
Day 3	0.90 ± 0.07	0.84 ± 0.13	0.77 ± 0.13	0.78 ± 0.07 ^b	0.64 ± 0.09	0.49 ± 0.08**
Day 23	0.72 ± 0.09	0.54 ± 0.05	0.85 ± 0.08	0.67 ± 0.10	0.43 ± 0.07	0.47 ± 0.11
Week 13	1.25 ± 0.17	1.30 ± 0.13	1.22 ± 0.13	1.64 ± 0.33	1.84 ± 0.19	1.63 ± 0.21
Lymphocytes (10³/μL)						
Day 3	8.14 ± 0.34	8.91 ± 0.35	9.35 ± 0.28	8.75 ± 0.32 ^b	8.93 ± 0.21	7.36 ± 0.26
Day 23	5.39 ± 0.27	5.73 ± 0.38	5.08 ± 0.38	5.30 ± 0.18	5.25 ± 0.28	5.51 ± 0.45
Week 13	7.96 ± 0.59	6.47 ± 0.23	6.66 ± 0.44	8.33 ± 0.66	7.83 ± 0.66	8.69 ± 0.75

TABLE G1
Hematology and Clinical Chemistry Data for Rats in the 13-Week Inhalation Study of Nitromethane (continued)

	0 ppm	94 ppm	188 ppm	375 ppm	750 ppm	1,500 ppm
Female (continued)						
Hematology (continued)						
n						
Day 3	10	10	10	10	10	10
Day 23	10	10	10	10	10	8
Week 13	10	10	10	10	10	10
Monocytes ($10^3/\mu\text{L}$)						
Day 3	0.20 ± 0.06	0.21 ± 0.04	0.26 ± 0.05	0.20 ± 0.04 ^b	0.23 ± 0.04	0.12 ± 0.03
Day 23	0.23 ± 0.04	0.26 ± 0.06	0.23 ± 0.03	0.19 ± 0.03	0.19 ± 0.05	0.23 ± 0.05
Week 13	0.33 ± 0.12	0.16 ± 0.04	0.17 ± 0.05	0.23 ± 0.06	0.26 ± 0.09	0.22 ± 0.05
Eosinophils ($10^3/\mu\text{L}$)						
Day 3	0.02 ± 0.01	0.01 ± 0.01	0.05 ± 0.02	0.05 ± 0.02 ^b	0.03 ± 0.02	0.06 ± 0.02
Day 23	0.02 ± 0.01	0.04 ± 0.01	0.04 ± 0.01	0.03 ± 0.01	0.03 ± 0.01	0.04 ± 0.04
Week 13	0.02 ± 0.01	0.06 ± 0.02	0.04 ± 0.02	0.07 ± 0.03	0.02 ± 0.02	0.06 ± 0.03
Methemoglobin (g/dL)						
Day 3	0.20 ± 0.03	0.27 ± 0.10	0.17 ± 0.04	0.10 ± 0.02*	0.11 ± 0.01	0.16 ± 0.01
Day 23	0.09 ± 0.01	0.10 ± 0.01 ^b	0.12 ± 0.01*	0.12 ± 0.01**	0.19 ± 0.01**	0.35 ± 0.01**
Week 13	0.20 ± 0.01	0.20 ± 0.01	0.20 ± 0.01	0.21 ± 0.01	0.25 ± 0.01**	0.40 ± 0.04**
Clinical Chemistry						
n						
Day 3	10	10	10	10	10	10
Day 23	10	9	10	10	10	8
Week 13	10	10	10	10	10	10
Urea nitrogen (mg/dL)						
Day 3	21.3 ± 0.6	17.8 ± 0.6**	17.2 ± 0.5**	16.6 ± 0.5**	16.9 ± 0.4**	17.5 ± 0.6**
Day 23	14.3 ± 0.6	14.0 ± 0.4	14.7 ± 0.2	13.7 ± 0.5	14.7 ± 0.4	16.0 ± 0.8
Week 13	22.6 ± 0.8	23.3 ± 1.0	21.9 ± 1.0	22.7 ± 1.1	22.6 ± 0.8	22.2 ± 0.8
Creatinine (mg/dL)						
Day 3	0.61 ± 0.04	0.79 ± 0.02**	0.75 ± 0.04**	0.66 ± 0.02*	0.73 ± 0.03*	0.99 ± 0.04**
Day 23	0.77 ± 0.03	0.70 ± 0.02	0.73 ± 0.03	0.71 ± 0.04	0.82 ± 0.04	1.28 ± 0.09**
Week 13	0.78 ± 0.03	0.79 ± 0.03	0.75 ± 0.02	0.79 ± 0.02	0.73 ± 0.02	0.74 ± 0.02
Total protein (g/dL)						
Day 3	6.6 ± 0.1	6.2 ± 0.1*	6.5 ± 0.1	6.7 ± 0.1	6.5 ± 0.1	6.4 ± 0.1
Day 23	7.2 ± 0.1	6.8 ± 0.1	7.2 ± 0.1	7.1 ± 0.1	7.0 ± 0.1	6.5 ± 0.1**
Week 13	7.4 ± 0.1	7.4 ± 0.1	7.7 ± 0.1	7.2 ± 0.3	7.5 ± 0.1	7.0 ± 0.1
Albumin (g/dL)						
Day 3	4.5 ± 0.1	4.2 ± 0.1	4.4 ± 0.1	4.5 ± 0.1	4.5 ± 0.0	4.7 ± 0.1
Day 23	4.9 ± 0.1	4.6 ± 0.1*	4.8 ± 0.1	4.8 ± 0.1	4.9 ± 0.1	4.7 ± 0.1
Week 13	5.1 ± 0.1	5.1 ± 0.1	5.4 ± 0.1	5.0 ± 0.2	5.3 ± 0.1	4.9 ± 0.1
Globulin (g/dL)						
Day 3	2.1 ± 0.1	2.0 ± 0.1	2.1 ± 0.1	2.3 ± 0.0	2.0 ± 0.1	1.8 ± 0.0*
Day 23	2.3 ± 0.1	2.2 ± 0.1	2.4 ± 0.0	2.3 ± 0.1	2.1 ± 0.1	1.8 ± 0.1**
Week 13	2.3 ± 0.1	2.4 ± 0.1	2.2 ± 0.1	2.1 ± 0.1	2.2 ± 0.1	2.1 ± 0.1

TABLE G1
Hematology and Clinical Chemistry Data for Rats in the 13-Week Inhalation Study of Nitromethane (continued)

	0 ppm	94 ppm	188 ppm	375 ppm	750 ppm	1,500 ppm
Female (continued)						
Clinical Chemistry (continued)						
n						
Day 3	10	10	10	10	10	10
Day 23	10	9	10	10	10	8
Week 13	10	10	10	10	10	10
Alanine aminotransferase (IU/L)						
Day 3	34 ± 1	37 ± 1	33 ± 1	36 ± 1	34 ± 1	32 ± 1 ^b
Day 23	29 ± 2	30 ± 1	31 ± 1	31 ± 1	28 ± 1	26 ± 1
Week 13	51 ± 3	47 ± 4	53 ± 7	46 ± 5	38 ± 2*	38 ± 4**
Alkaline phosphatase (IU/L)						
Day 3	762 ± 36	706 ± 21	718 ± 24	747 ± 20	678 ± 22	643 ± 23**
Day 23	415 ± 15	479 ± 9	416 ± 6	388 ± 11	403 ± 15	368 ± 7*
Week 13	348 ± 15	354 ± 17	327 ± 19	317 ± 27	332 ± 9	322 ± 12
Creatine kinase (IU/L)						
Day 3	366 ± 45	357 ± 9 ^b	434 ± 51	416 ± 23	398 ± 34	302 ± 32
Day 23	502 ± 178 ^b	364 ± 62	333 ± 43	316 ± 55	193 ± 20*	207 ± 25
Week 13	191 ± 29	181 ± 19	120 ± 11	173 ± 19	145 ± 27	128 ± 19
Sorbitol dehydrogenase (IU/L)						
Day 3	10 ± 1	11 ± 0	8 ± 1	10 ± 1	10 ± 1	10 ± 0
Day 23	13 ± 0	12 ± 1	12 ± 1	12 ± 0	11 ± 1**	11 ± 1**
Week 13	10 ± 1	11 ± 1	10 ± 1	10 ± 1	8 ± 0*	9 ± 1*
Bile acids (μmol/L)						
Day 3	9.8 ± 1.2 ^c	8.2 ± 1.1 ^b	10.4 ± 2.3 ^d	8.7 ± 2.2 ^d	9.0 ± 0.8	7.7 ± 1.6
Day 23	10.6 ± 1.3	11.3 ± 1.4 ^c	7.2 ± 1.4 ^b	7.6 ± 2.2	8.6 ± 2.4	10.9 ± 4.0
Week 13	13.4 ± 2.8	7.7 ± 1.8	13.7 ± 3.7	9.2 ± 1.9	16.5 ± 4.4	22.9 ± 5.5
Thyroid-stimulating hormone (ng/mL)						
Day 23	0.1 ± 0.1 ^g	0.5 ± 0.2 ^e	0.5 ± 0.1 ^c	0.4 ± 0.2 ^f	0.6 ± 0.1* ^b	0.5 ± 0.1 ^f
Week 13	1.7 ± 0.2	2.1 ± 0.3	1.7 ± 0.2	1.6 ± 0.3 ^b	2.0 ± 0.3	1.7 ± 0.2
Triiodothyronine (ng/dL)						
Day 23	110 ± 5	107 ± 6	109 ± 7	96 ± 5	92 ± 4*	85 ± 3**
Week 13	150 ± 12	148 ± 12	163 ± 10	152 ± 14	148 ± 10	136 ± 12
Thyroxine (μg/dL)						
Day 23	4.8 ± 0.2	4.6 ± 0.2	4.1 ± 0.3*	3.6 ± 0.1**	3.3 ± 0.2**	3.2 ± 0.2**
Week 13	4.6 ± 0.4	4.1 ± 0.3	4.3 ± 0.2	4.0 ± 0.2	3.7 ± 0.2	4.0 ± 0.3
Free thyroxine (ng/dL)						
Day 23	0.9 ± 0.1 ^c	1.1 ± 0.1 ^c	0.9 ± 0.1	0.7 ± 0.0 ^b	0.5 ± 0.1**	0.5 ± 0.0**
Week 13	0.9 ± 0.1	0.7 ± 0.1	0.7 ± 0.1	0.7 ± 0.1	0.6 ± 0.1	0.7 ± 0.1

* Significantly different ($P \leq 0.05$) from the control group by Dunn's or Shirley's test.

** $P \leq 0.01$

^a Mean ± standard error. Statistical tests were performed on unrounded data.

^b n=9

^c n=8

^d n=7

^e n=5

^f n=6

^g n=4

APPENDIX H
REPRODUCTIVE TISSUE EVALUATIONS
AND ESTROUS CYCLE CHARACTERIZATION

TABLE H1	Summary of Reproductive Tissue Evaluations and Estrous Cycle Characterization for Rats in the 13-Week Inhalation Study of Nitromethane	250
TABLE H2	Summary of Reproductive Tissue Evaluations and Estrous Cycle Characterization for Mice in the 13-Week Inhalation Study of Nitromethane	251

TABLE H1
Summary of Reproductive Tissue Evaluations and Estrous Cycle Characterization for Rats
in the 13-Week Inhalation Study of Nitromethane^a

	0 ppm	375 ppm	750 ppm	1,500 ppm
Male				
n	10	10	10	10
Weights (g)				
Necropsy body wt	338 ± 7	341 ± 4	331 ± 4	299 ± 11**
L. cauda	0.207 ± 0.004	0.210 ± 0.004	0.204 ± 0.006	0.177 ± 0.009**
L. epididymis	0.467 ± 0.009	0.468 ± 0.006	0.444 ± 0.009	0.412 ± 0.013**
L. testis	1.39 ± 0.03	1.36 ± 0.01	1.34 ± 0.02	1.29 ± 0.02**
Spermatid measurements				
Spermatid heads (10 ⁷ /g testis)	9.21 ± 0.46	9.23 ± 0.50	9.35 ± 0.45	10.73 ± 0.50
Spermatid heads (10 ⁷ /testis)	12.87 ± 0.78	12.55 ± 0.73	12.54 ± 0.60	13.79 ± 0.63
Spermatid count (mean/10 ⁻⁴ mL suspension)	64.33 ± 3.89	62.75 ± 3.63	62.68 ± 3.02	68.95 ± 3.14
Epididymal spermatozoal measurements				
Motility (%)	94.57 ± 1.30	92.16 ± 1.90	87.11 ± 1.88**	76.43 ± 2.78**
Concentration (10 ⁶ /g cauda epididymal tissue)	449 ± 45	483 ± 24	434 ± 35	380 ± 42
Female				
n	10	10	10	10
Necropsy body wt (g)	188 ± 5	200 ± 5	195 ± 4	178 ± 3
Estrous cycle length (days)	4.89 ± 0.07 ^b	4.75 ± 0.16 ^c	5.00 ± 0.14 ^b	5.00 ± 0.15
Estrous stages (% of cycle)				
Diestrus	30.8	26.7	35.8	30.0
Proestrus	15.8	13.3	16.7	12.5
Estrus	23.3	23.3	25.8	26.7
Metestrus	14.2	11.7	11.7	14.2
Uncertain diagnoses	15.8	25.0	10.0	16.7

** Significantly different ($P \leq 0.01$) from the control group by Williams' or Dunnett's test (body and tissue weights) or by Shirley's test (motility)

^a Weights, spermatid and epididymal spermatozoal measurements, and estrous cycle lengths are presented as mean ± standard error. Differences from the control group for spermatid measurements, epididymal spermatozoal concentration, and estrous cycle length are not significant by Dunn's test. By multivariate analysis of variance, exposed females do not differ significantly from the control females in the relative length of time spent in the estrous stages.

^b Estrous cycle was longer than 12 days or unclear in 1 of 10 animals.

^c Estrous cycle was longer than 12 days or unclear in 2 of 10 animals.

TABLE H2
Summary of Reproductive Tissue Evaluations and Estrous Cycle Characterization for Mice
in the 13-Week Inhalation Study of Nitromethane^a

	0 ppm	375 ppm	750 ppm	1,500 ppm
Male				
n	10	10	10	10
Weights (g)				
Necropsy body wt	36.1 ± 0.5	36.3 ± 0.6	35.2 ± 0.4	34.7 ± 0.5
L. cauda	0.020 ± 0.001	0.019 ± 0.001	0.020 ± 0.001	0.018 ± 0.001
L. epididymis	0.049 ± 0.002	0.047 ± 0.002	0.050 ± 0.002	0.050 ± 0.003
L. testis	0.118 ± 0.003	0.121 ± 0.002	0.117 ± 0.003	0.121 ± 0.001
Spermatid measurements				
Spermatid heads (10 ⁷ /g testis)	22.53 ± 0.46	20.45 ± 0.62	21.22 ± 0.83	21.82 ± 0.81
Spermatid heads (10 ⁷ /testis)	2.65 ± 0.06	2.46 ± 0.06	2.48 ± 0.10	2.64 ± 0.10
Spermatid count (mean/10 ⁻⁴ mL suspension)	82.80 ± 1.89	76.85 ± 1.80	77.43 ± 3.11	82.58 ± 3.14
Epididymal spermatozoal measurements				
Motility (%)	93.50 ± 0.46	85.09 ± 1.21**	86.47 ± 1.17**	82.41 ± 1.30**
Concentration (10 ⁶ /g cauda epididymal tissue)	1,106 ± 84	1,035 ± 95	1,048 ± 85	1,244 ± 138
Female				
n	10	10	10	10
Necropsy body wt (g)	31.1 ± 0.7	34.2 ± 0.8	31.5 ± 0.5	30.4 ± 0.5
Estrous cycle length (days)	4.00 ± 0.00 ^c	4.33 ± 0.14 ^{*d}	4.50 ± 0.21 [*]	4.71 ± 0.26 ^{**e}
Estrous stages^b (% of cycle)				
Diestrus	25.0	16.7	25.8	25.0
Proestrus	10.0	17.5	20.8	15.0
Estrus	33.3	25.8	23.3	24.2
Metestrus	9.2	13.3	17.5	16.7
Uncertain diagnoses	22.5	26.7	12.5	19.2

* Significantly different ($P \leq 0.05$) from the control group by Shirley's test

** $P \leq 0.01$

^a Weights, spermatid and epididymal spermatozoal measurements, and estrous cycle lengths are presented as mean ± standard error. Differences from the control group for weights, spermatid measurements, and epididymal spermatozoal concentration are not significant by Dunn's or Dunnett's test.

^b Evidence shows that females exposed to 750 or 1,500 ppm differ significantly (Wilk's Criterion, $P \leq 0.05$) from the control females in the relative length of time spent in the estrous stages. Exposed females spent more time in metestrus and proestrus and less time in estrus than control females.

^c Estrous cycle was longer than 12 days or unclear in 2 of 10 animals.

^d Estrous cycle was longer than 12 days or unclear in 1 of 10 animals.

^e Estrous cycle was longer than 12 days or unclear in 3 of 10 animals.

APPENDIX I
NEUROBEHAVIORAL
EVALUATION RESULTS

TABLE II	Neurobehavior Data for Rats in the 13-Week Inhalation Study of Nitromethane	254
-----------------	--	------------

TABLE II
Neurobehavior Data for Rats in the 13-Week Inhalation Study of Nitromethane^a

	0 ppm	94 ppm	188 ppm	375 ppm	750 ppm	1,500 ppm
n	10	10	10	10	10	10
Male						
Forelimb grip strength (kg)	0.617 ± 0.025	0.554 ± 0.015	0.583 ± 0.037	0.592 ± 0.021	0.568 ± 0.029	0.471 ± 0.024**
Hindlimb grip strength (kg)	0.433 ± 0.020	0.399 ± 0.026	0.407 ± 0.020	0.378 ± 0.023	0.382 ± 0.017	0.213 ± 0.020**
Tailflick latency (seconds)	2.90 ± 0.40	2.22 ± 0.24	2.51 ± 0.24	2.67 ± 0.31	2.93 ± 0.33	2.31 ± 0.39
Startle response amplitude (volts)	61.85 ± 14.42 ^b	69.80 ± 6.43	65.37 ± 7.15	42.13 ± 4.00	38.98 ± 4.54 ^b	42.57 ± 4.53
Startle response latency (milliseconds)	42.82 ± 2.74 ^b	47.92 ± 2.08	40.93 ± 2.61	40.25 ± 2.66	38.35 ± 1.63 ^b	48.88 ± 3.12
Female						
Forelimb grip strength (kg)	0.598 ± 0.020	0.633 ± 0.021	0.700 ± 0.011**	0.619 ± 0.029	0.585 ± 0.019	0.632 ± 0.018
Hindlimb grip strength (kg)	0.403 ± 0.018	0.425 ± 0.011	0.435 ± 0.014	0.419 ± 0.013	0.333 ± 0.019**	0.209 ± 0.015**
Tailflick latency (seconds)	2.67 ± 0.16	3.10 ± 0.36	3.08 ± 0.33	3.09 ± 0.27	2.71 ± 0.32	1.79 ± 0.26
Startle response amplitude (volts)	29.88 ± 3.49	43.82 ± 7.00*	38.67 ± 2.25	32.92 ± 3.47	24.47 ± 1.25	27.17 ± 2.39
Startle response latency (milliseconds)	39.13 ± 1.22	42.20 ± 1.50	38.17 ± 1.75	42.44 ± 2.78	37.28 ± 2.41	39.90 ± 2.06

* Significantly different ($P \leq 0.05$) from the control group by Williams' or Dunnett's test

** $P \leq 0.01$

^a Mean ± standard error

^b n=9

APPENDIX J

CHEMICAL CHARACTERIZATION AND GENERATION OF CHAMBER CONCENTRATIONS

PROCUREMENT AND CHARACTERIZATION OF NITROMETHANE	256
VAPOR GENERATION AND EXPOSURE SYSTEM	257
VAPOR CONCENTRATION MONITORING	258
CHAMBER ATMOSPHERE CHARACTERIZATION	258
FIGURE J1 Infrared Absorption Spectrum of Nitromethane	261
FIGURE J2 Nuclear Magnetic Resonance Spectrum of Nitromethane	262
FIGURE J3 Nitromethane Vapor Generator	263
FIGURE J4a Nitromethane Vapor Generation and Delivery System for the 16-Day Studies	264
FIGURE J4b Nitromethane Vapor Generation and Delivery System for the 13-Week and 2-Year Studies	265
FIGURE J5 Nitromethane Inhalation Exposure Chamber	266
FIGURE J6a Nitromethane Exposure Suite for the 16-Day Studies	267
FIGURE J6b Nitromethane Exposure Suite for the 13-Week and 2-Year Studies	268
TABLE J1 Summary of Chamber Concentrations in the 16-Day Inhalation Studies of Nitromethane	269
TABLE J2 Summary of Chamber Concentrations in the 13-Week Inhalation Studies of Nitromethane	269
TABLE J3 Summary of Chamber Concentrations in the 2-Year Inhalation Studies of Nitromethane	270
FIGURE J7 Monthly Mean Concentration and Standard Deviation in the 94 ppm Rat Exposure Chamber in the 2-Year Inhalation Study of Nitromethane	271
FIGURE J8 Monthly Mean Concentration and Standard Deviation in the 188 ppm Rat Exposure Chamber in the 2-Year Inhalation Study of Nitromethane	272
FIGURE J9 Monthly Mean Concentration and Standard Deviation in the 375 ppm Rat Exposure Chamber in the 2-Year Inhalation Study of Nitromethane	273
FIGURE J10 Monthly Mean Concentration and Standard Deviation in the 188 ppm Mouse Exposure Chamber in the 2-Year Inhalation Study of Nitromethane	274
FIGURE J11 Monthly Mean Concentration and Standard Deviation in the 375 ppm Mouse Exposure Chamber in the 2-Year Inhalation Study of Nitromethane	275
FIGURE J12 Monthly Mean Concentration and Standard Deviation in the 750 ppm Mouse Exposure Chamber in the 2-Year Inhalation Study of Nitromethane	276

CHEMICAL CHARACTERIZATION AND GENERATION OF CHAMBER CONCENTRATIONS

PROCUREMENT AND CHARACTERIZATION OF NITROMETHANE

Nitromethane was obtained from W.R. Grace and Company (Lexington, MA) in three lots. Lot 1F 13 06 was used during the 16-day studies and the beginning of the 13-week studies; lot 1-H-0501, which was received in two shipments (batches 2 and 3), was used throughout the remainder of the 13-week studies and at the beginning of the 2-year studies. Lot 1-H-1004 was used throughout the remainder of the 2-year studies. Identity, purity, and stability analyses were conducted by the analytical chemistry laboratory, Midwest Research Institute (Kansas City, MO). Reports on the analyses performed in support of the nitromethane studies are on file at the National Institute of Environmental Health Sciences.

The chemical, a clear, colorless liquid, was identified as nitromethane by infrared, ultraviolet/visible, and nuclear magnetic resonance spectrometry. All spectra were consistent with those expected for the structure and with the literature spectra (*Sadtler Standard Spectra*) of nitromethane. The infrared and nuclear magnetic resonance spectra are presented in Figures J1 and J2. The boiling point and density of the chemical were also consistent with literature references (*Merck Index*, 1983).

The purity of each lot was determined by elemental analysis, Karl Fischer water analysis, functional group titration, and gas chromatography. For indirect iodometric titration, aqueous nitromethane samples were reacted with hypochlorite in 0.25 N sodium hydroxide and then cooled; the excess hypochlorite was reacted with potassium iodide in an acidic medium, and the liberated iodine was titrated with 0.1 N sodium thiosulfate to the starch endpoint. Gas chromatography was performed with a flame ionization detector. Two systems were used:

- A) 80/100 Carbopack C/0.1% SP-1000 glass column, with an oven temperature program of 50° C for 5 minutes, then 50° to 225° C at 10° C per minute, and a nitrogen carrier gas at a flow rate of 70 mL/minute and
- B) DB-Wax fused silica column with an oven temperature program of 40° C for 5 minutes, then 40° to 230° C at 10° C per minute, a helium carrier gas at a flow rate of 10 mL/minute, and a nitrogen makeup gas at a flow rate of 25 mL/minute (20 mL/minute for lot 1-H-1004).

For lot 1F 13 06, elemental analyses of carbon and hydrogen agreed with the theoretical values for nitromethane, but results for nitrogen were low. Karl Fischer water analysis indicated 0.022% \pm 0.004% water. Functional group titration indicated a purity of 100% \pm 1%. Both gas chromatographic systems indicated one major peak and one impurity with an area greater than 0.1% relative to the major peak. The area of the impurity peak indicated by system A was 0.62% relative to the major peak; the area of the impurity peak indicated by system B was 0.52% relative to the major peak. The overall purity of lot 1F 13 06 was determined to be approximately 99%.

Additional analyses of lot 1F 13 06 were performed with gas chromatography/mass spectrometry to identify the impurity indicated by gas chromatography. The gas chromatograph system included an 80/100 Carbopack C/0.1% SP-1000 column with an oven temperature program of 40° C for 4 minutes, then 40° to 220° C at 10° C per minute, and a helium carrier gas at a flow rate of 30 mL/minute. The mass spectrum of the impurity was consistent with that of propionitrile; an additional impurity observed in the sample was identified as 2-nitropropane. The quantity of propionitrile was determined with gas chromatography by system A described under the purity analyses, but with a final temperature of 200° C

and with cyclohexane as an internal standard; a concentration of $0.400\% \pm 0.001\%$ propionitrile was determined. The quantity of 2-nitropropane, determined with the same gas chromatographic system but with cyclohexanone as an internal standard, was determined to be $0.017\% \pm 0.000\%$.

For lot 1-H-0501 (batch 2), the supplier indicated a purity of 99.3% for the bulk chemical, with 0.27% nitroethane present as a contaminant. Elemental analyses of carbon and hydrogen by the analytical chemistry laboratory agreed with the theoretical values for nitromethane, but results for nitrogen were low. Karl Fischer water analysis indicated $0.018\% \pm 0.003\%$ water. Functional group titration indicated a purity of $98.9\% \pm 0.8\%$. Gas chromatography with system A indicated one major peak and three impurities with a combined area of 1.69% relative to the major peak; the major impurity was identified as propionitrile. System B indicated one major peak and two impurities with a combined area of 1.49% relative to the major peak. Batch 3 of lot 1-H-0501 was also analyzed with gas chromatographic system A; one major peak and three impurities with a total peak area 1.71% relative to the major peak were identified, with the major impurity identified as propionitrile. Major peak comparisons of batch 2 with lot 1F 13 06 and of batch 3 with batch 2 were performed with gas chromatography with a flame ionization detector, 10% SP-1000 on 80/100 Supelcoport glass column, a nitrogen carrier gas at 70 mL/minute, an oven temperature program of 80° C for 4 minutes, then 80° to 130° C at 10° C per minute, and tridecane as an internal standard. The results indicated a purity of $99.3\% \pm 0.3\%$ for batch 2 of lot 1-H-0501 relative to lot 1F 13 06 and a purity of $99.5\% \pm 0.5\%$ for batch 3 relative to batch 2. The overall purity of lot 1-H-0501 was determined to be approximately 98%.

For lot 1-H-1004, the supplier indicated a 99% purity of the bulk chemical, with nitroethane (0.25%) and 2-nitropropane (0.03%) present as contaminants. Elemental analyses of carbon and hydrogen by the analytical chemistry laboratory agreed with the theoretical values for nitromethane, but results for nitrogen were low. Karl Fischer water analysis indicated $0.086\% \pm 0.006\%$ water. Functional group titration indicated a purity of $97.8\% \pm 0.5\%$. Gas chromatography with system A indicated one major peak and three impurities with a combined area of 1.5% relative to the major peak; the major impurity was identified as propionitrile. System B indicated one major peak and three impurities with a combined area of 1.9% relative to the major peak. Major peak comparison of lot 1-H-1004 with lot 1F 13 06 by gas chromatography by the system described for major peak comparisons of lot 1-H-0501, but with an isothermal oven temperature of 80° C, indicated a purity of $100.3\% \pm 0.9\%$ for lot 1-H-1004 relative to lot 1F 13 06. The overall purity of lot 1-H-1004 was determined to be approximately 98%.

Accelerated stability studies of lots 1F 13 06 and 1-H-0501 of the bulk chemical were conducted with the gas chromatography system described for the major peak comparisons of lot 1-H-0501, but with an isothermal oven temperature of 80° C for lot 1F 13 06. Nitromethane was determined to be stable as a bulk chemical when stored in Teflon[®]-lined amber glass bottles, protected from light, for up to 2 weeks at temperatures up to 60° C. To ensure stability, the bulk chemical was stored in the original shipping containers (metal drums and amber glass bottles) at room temperature; lot 1F 13 06 was stored under a nitrogen headspace. Stability was monitored by the study laboratory throughout the studies with gas chromatography; no degradation of the bulk chemical was detected.

VAPOR GENERATION AND EXPOSURE SYSTEM

Nitromethane was held in a stainless-steel reservoir under a nitrogen blanket; a MasterFlex variable-speed peristaltic pump head (Cole-Parmer, Inc., Chicago, IL) was used to pump nitromethane through a liquid distribution manifold of stainless steel tubing to heated-wick vaporizers (Figure J3). Before and during the 16-day studies, the rubber tubing in the peristaltic pump used to deliver nitromethane to the generation system was analyzed for suitability by testing for flexibility, size, appearance, and weight loss on drying; no deterioration was noted. Nitromethane cycled through and held in the tubing was also analyzed for

purity and for the presence of phthalates by gas chromatography; results indicated that the sample had a purity of greater than 99%, and no phthalates were detected. The tubing was replaced immediately before the 16-day studies began and every 2 weeks during the 13-week and 2-year studies.

During the 16-day studies, single vaporizers were used for each of the 750 and 1,500 ppm chambers, and a third vaporizer was located in the vapor distribution system that supplied the 94, 188, and 375 ppm chambers (Figure J4a). During the 13-week and 2-year studies, one set of dual vaporizers supplied nitromethane vapor to all chambers (Figure J4b). Each vaporizer consisted of a stainless-steel cylinder covered with a glass fiber wick from which the liquid nitromethane was vaporized (Decker *et al.*, 1982). An 80-watt heater and two temperature-sensing elements were located within the cylinder. One sensing element was connected to a remote temperature controller that maintained the generator at approximately 84° to 91° C; the second element allowed monitoring of the vaporizer and was connected to an alarm that automatically shut off the flow of nitromethane to the vaporizer if the temperature exceeded 120° C. Vapor was generated by drawing filtered air across the vaporizer and into the vapor distribution line.

The vapor-laden air was transferred through the distribution line, where it was diluted with HEPA- and charcoal-filtered air, to the inhalation chambers; three-way valves mounted in the chamber inlet ducts allowed nitromethane vapors to be diverted to the exhaust until a stable concentration of nitromethane was built up in the distribution line. At each chamber, air moving through the chamber inlet duct was further diluted with HEPA- and charcoal-filtered air to the appropriate nitromethane concentration for the chamber with a metered three-way valve. Diagrams of the inhalation exposure chambers and exposure suites are shown in Figures J5, J6a, and J6b. The study laboratory designed the inhalation exposure chamber (Harford Systems Division of Lab Products, Inc., Aberdeen, MD) so that uniform vapor concentrations could be maintained throughout the chamber with the catch pans in place. The total active mixing volume of each chamber was 1.7 m³. A small particle detector (Type CN, Gardner Associates, Schenectady, NY) was used with and without animals in the exposure chambers to ensure that nitromethane vapor, and not aerosol, was produced. No particle counts above the minimum resolvable level (approximately 200 particles/cm³) were detected.

VAPOR CONCENTRATION MONITORING

Chamber concentrations were monitored with an on-line gas chromatograph. The monitor was coupled with the inhalation chambers by a computer-controlled 12-port stream select valve. Each chamber was sampled approximately every 36 minutes. The gas chromatograph calibration was checked daily against a commercial standard of nitromethane in nitrogen. Additionally, the gas chromatograph was calibrated by a comparison of chamber concentration data to data from grab samples analyzed by an off-line gas chromatograph; the grab samples were collected in bubblers containing dimethylformamide. The volumes of gas were sampled at a constant flow rate ensured by a calibrated critical orifice. The off-line gas chromatograph was calibrated with gravimetrically prepared nitromethane standards.

Summaries of the chamber concentrations for the 16-day, 13-week, and 2-year studies are in Tables J1 through J3. The monthly mean exposure concentrations for the 2-year study chambers are presented in Figures J7 through J12.

CHAMBER ATMOSPHERE CHARACTERIZATION

Buildup and decay rates for chamber concentrations were determined with and without animals present in the chambers. At a chamber airflow rate of 15 air changes per hour, the theoretical value for the time to achieve 90% of the target concentration after the beginning of vapor generation (T_{90}) and the time for the chamber concentration to decay to 10% of the target concentration after vapor generation was terminated

(T_{10}) was approximately 12.5 minutes. Room air was changed 12 to 18 times per hour during all studies. During the 16-day and 13-week studies, the mean T_{90} value with and without animals in the chambers was 11 minutes, ranging from 10 to 13 minutes during the 16-day studies and from 6 to 13 minutes during the 13-week studies. T_{10} ranged from 11 to 14 minutes during the 16-day studies and from 11 to 15 minutes during the 13-week studies. During the 2-year studies, T_{90} ranged from 11 to 14 minutes without animals and from 5 to 17 minutes with animals in the chambers; T_{10} ranged from 13 to 16 minutes without animals and from 13 to 19 minutes with animals. A T_{90} value of 12 minutes was selected for all studies.

The uniformity of vapor concentration in the inhalation exposure chambers without animals was evaluated before each of the studies began; concentration uniformity with animals present in the chambers was also measured once during the 16-day studies, twice during the 13-week studies, and approximately every 90 days during the 2-year studies. Vapor concentration was determined with the on-line gas chromatograph, with the 12-port sampling valve disabled to allow continuous monitoring from a single line; samples were taken from several positions in each chamber. Chamber concentration uniformity was maintained throughout the 16-day, 13-week, and 2-year studies.

The persistence of nitromethane in the chamber following exposure was determined by monitoring overnight the concentration in the 1,500 ppm chamber in the 16-day and 13-week studies, the 375 ppm chamber in the 2-year rat study, and the 750 ppm chamber in the 2-year mouse study, with and without animals present. During the 16-day studies, the chamber concentration decreased to less than 1% of the target concentration within 100 minutes after the nitromethane flow was shut off. In the 13-week studies, the concentration decreased to 1% of the target concentration within 55 minutes with no animals present and within 100 to 140 minutes with animals present. Approximately 1.5 ppm nitromethane was detected in the chamber the morning after testing during the 16-day and 13-week studies. In the 2-year rat study, the time for the concentration to decrease to 1% of the target concentration ranged from 112 to 315 minutes. In the 2-year mouse study, the concentration decreased to 1% of the target concentration within 89 to 178 minutes.

Nitromethane from the vapor generator reservoir was tested for stability during all studies with gas chromatography, with a nitromethane standard as a reference. Results indicated that nitromethane was stable in the reservoir for at least 61 days. Because nitromethane was flash vaporized, the most likely type of decomposition resulting from the generation system would be thermal; these degradation products would include nitric acid, nitrous acid, methanol, formaldehyde, and formic acid. Stability was monitored by testing nitromethane samples collected from the generator reservoir, vapor distribution line, and exposure chambers for nitrous and nitric acid during the 16-day studies and for formaldehyde, methanol, and other volatile compounds during the 13-week studies. During the 16-day studies, samples collected from the vapor distribution line and the 94 and 1,500 ppm exposure chambers, with and without animals, were monitored for nitrous and nitric acid by analyzing bubbler samples with ion chromatography. Blanks from the control chamber were used to correct organic carbon measurements for the amount of carbon as carbon dioxide present in the bubblers. No more than 0.2% nitrate and 0.3% nitrite were detected in any sample.

During the 13-week studies, samples from the vapor distribution line and the unoccupied 94 and 1,500 ppm chambers were tested for formaldehyde. Samples were collected in adsorbent particulate tubes coated with N-benzylethanolamine; the reactivity between the formaldehyde and nitromethane in the tubes confounded attempts to measure formaldehyde but made the presence of free formaldehyde in the chambers unlikely. Bubbler samples collected from the vapor distribution line before and after exposure periods and from the occupied and unoccupied 94 and 1,500 ppm chambers were tested for methanol and other degradation products by gas chromatography/headspace analysis during the 13-week studies. In all reservoir and chamber samples (except some reservoir samples that were apparently contaminated during

sample preparation), methanol was below the limit of detection, with a bubbler collection efficiency of approximately 85%. These results indicated that no degradation of nitromethane occurred as a result of vapor generation during the studies.

The concentration of the impurity 2-nitropropane was monitored during all studies. During the 16-day studies, samples from the 1,500 ppm exposure chamber with and without animals were collected on adsorbent tubes; during the 13-week and 2-year studies, bubbler samples were collected from the distribution line and the 94 and 1,500 ppm (13-week) or 94 and 750 ppm (2-year) exposure chambers with and without animals. During the 13-week and 2-year studies, concentrations of nitroethane and propionitrile were also monitored. At the beginning of the 2-year studies, a third impurity present in the bulk chemical was identified as isooxazole with gas chromatography/mass spectrometry; the concentration of isooxazole was also monitored during the 2-year studies. In all studies, impurities in the samples were quantitated versus gravimetrically prepared standards by gas chromatography; the amount of each impurity detected in all distribution line and exposure chamber samples was the same as that detected in the reservoir, indicating that the impurities were neither concentrated nor dispersed by the generation system.

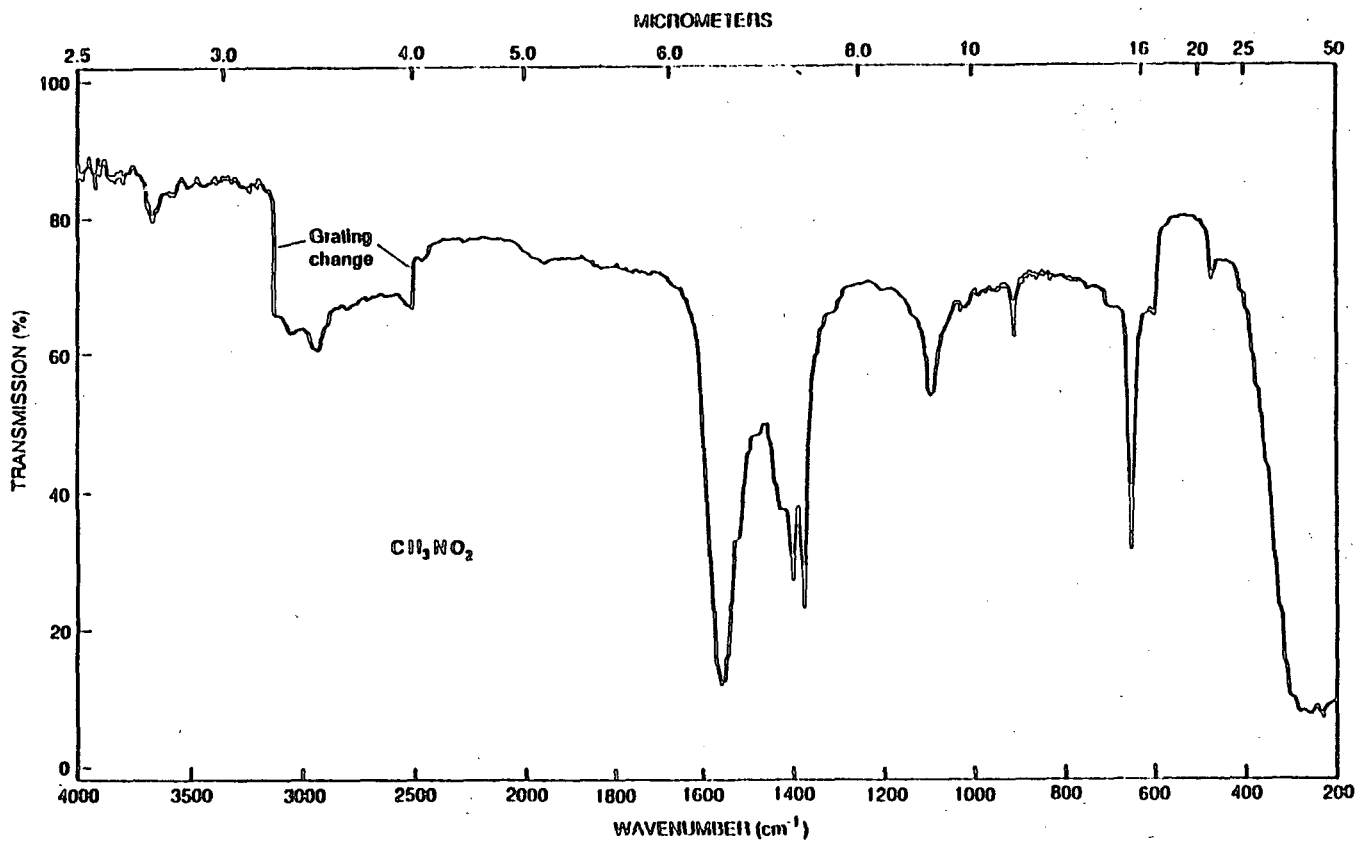

FIGURE J1
Infrared Absorption Spectrum of Nitromethane

ABSCISSA		ORDINATE		SCAN TIME 12 min	REP. SCAN -- SINGLE BEAM --
EXPANSION 0	EXPANSION 0	RESPONSE 1	% T 0-100 ATC --	TIME LIVE --	PRE SAMPLE CHECK --
SUPPRESSION --		SPLIT PROGRAM 6		OPERATOR H. Cameron	DATE 6/12/88
SAMPLE: Nitromethane Lot No.: 111-0501 Batch No.: 02 Task No.: OE-2179		REMARKS: Fabricator controls reference beam		SOLVENT --	CELL PATH: Neat film between Silver chloride plates
				CONCENTRATION: Neat	REFERENCE: 394M

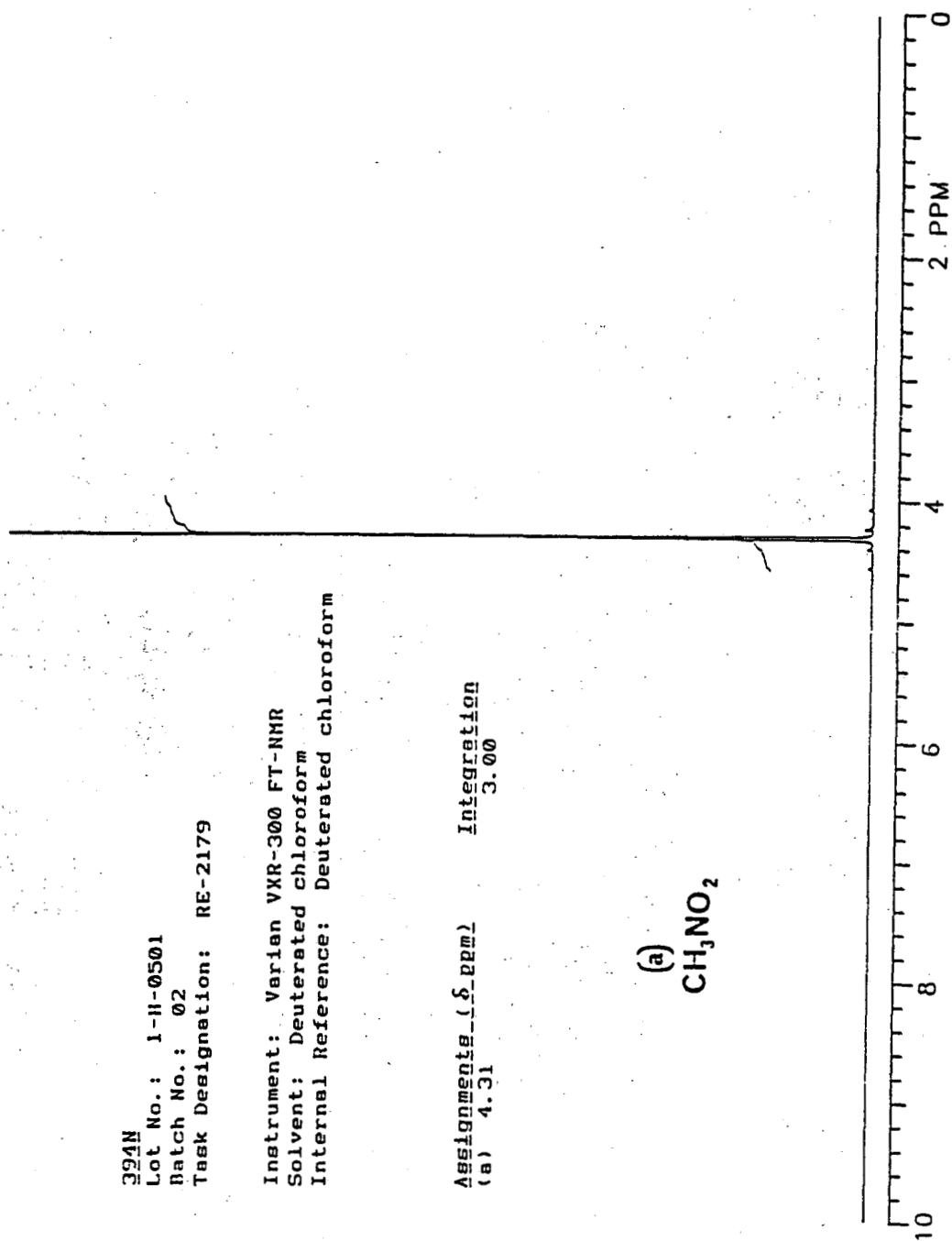

FIGURE J2
Nuclear Magnetic Resonance Spectrum of Nitromethane

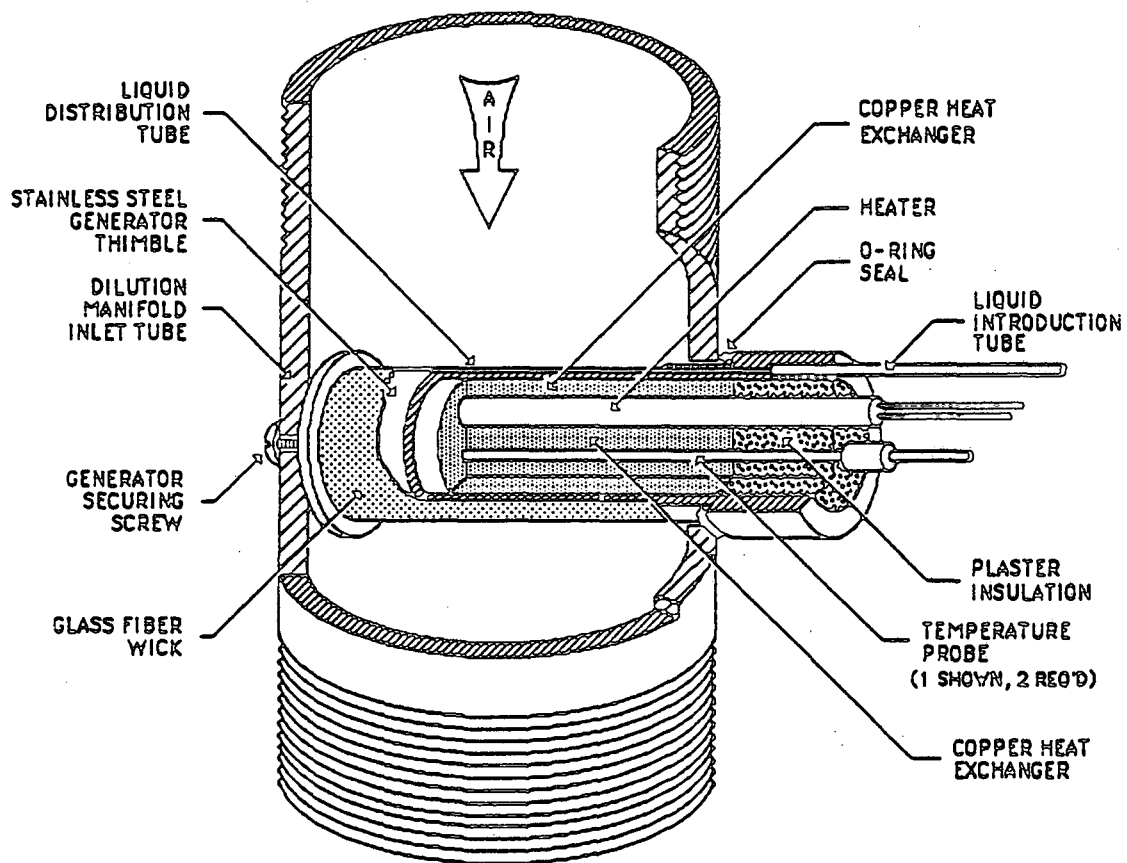

FIGURE J3
Nitromethane Vapor Generator

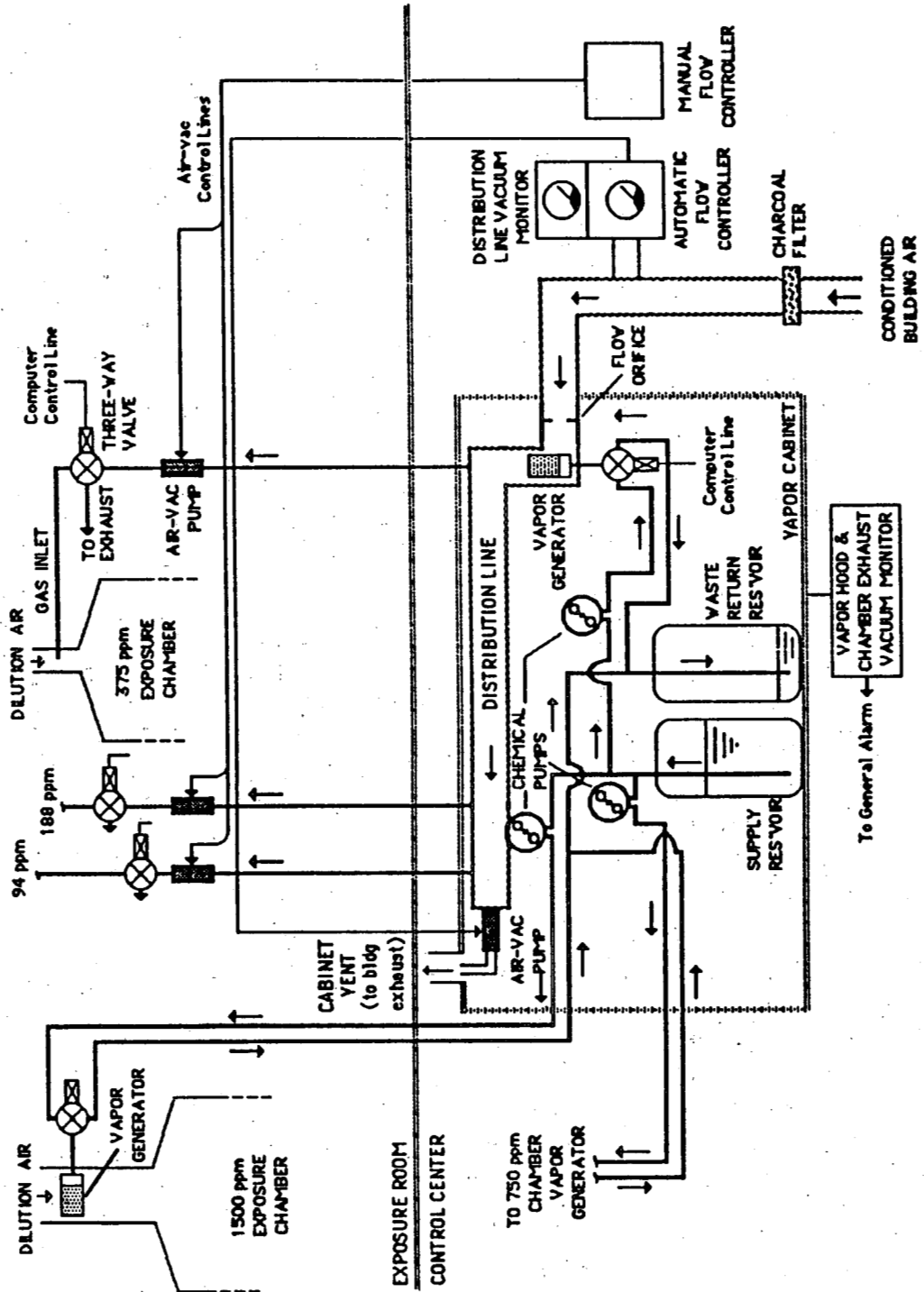

FIGURE J4a
Nitromethane Vapor Generation and Delivery System
for the 16-Day Studies

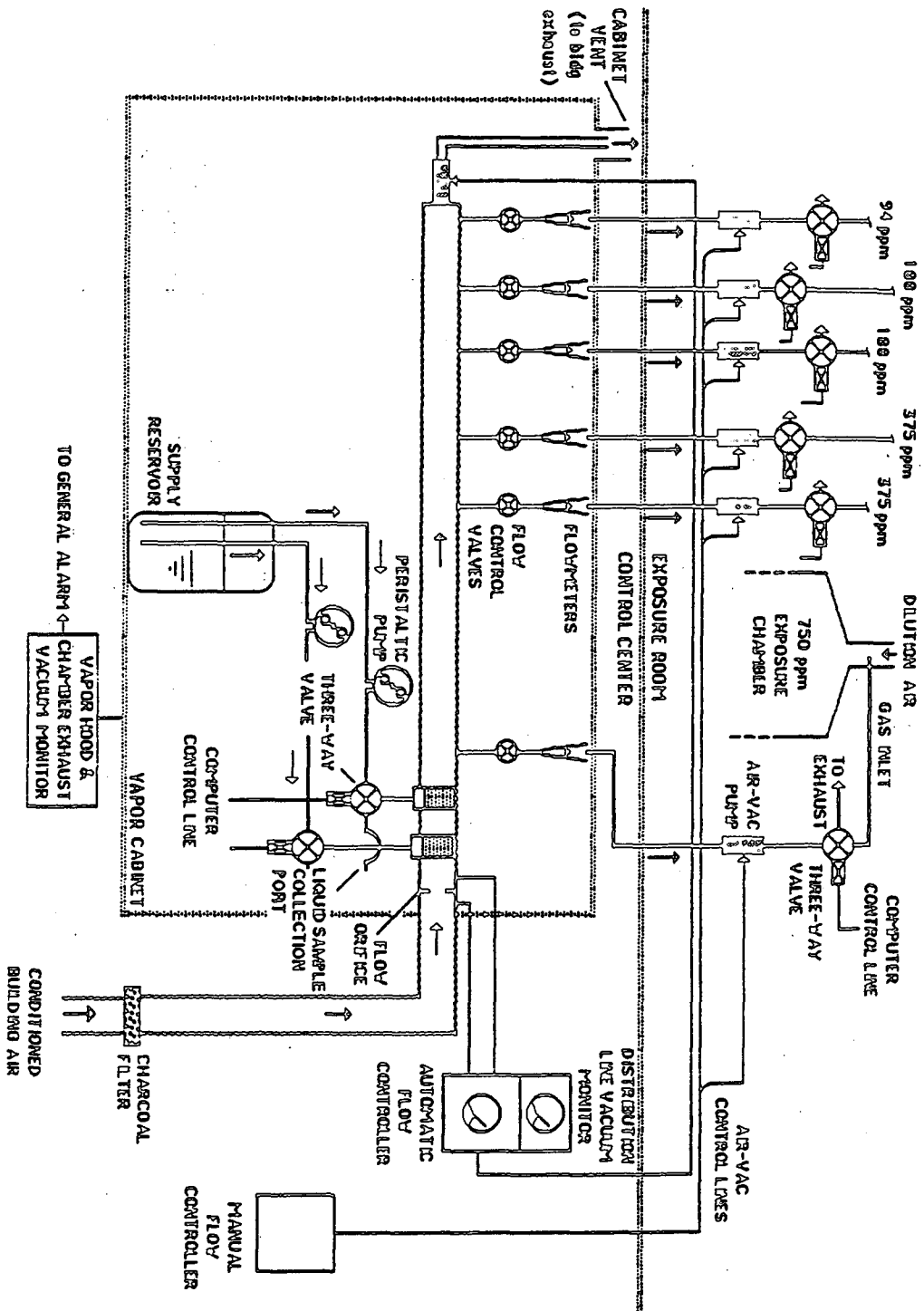
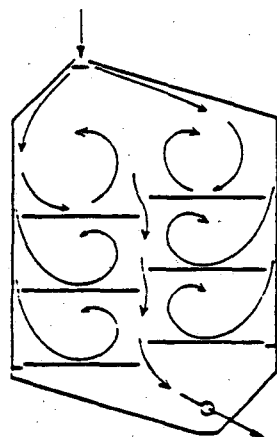
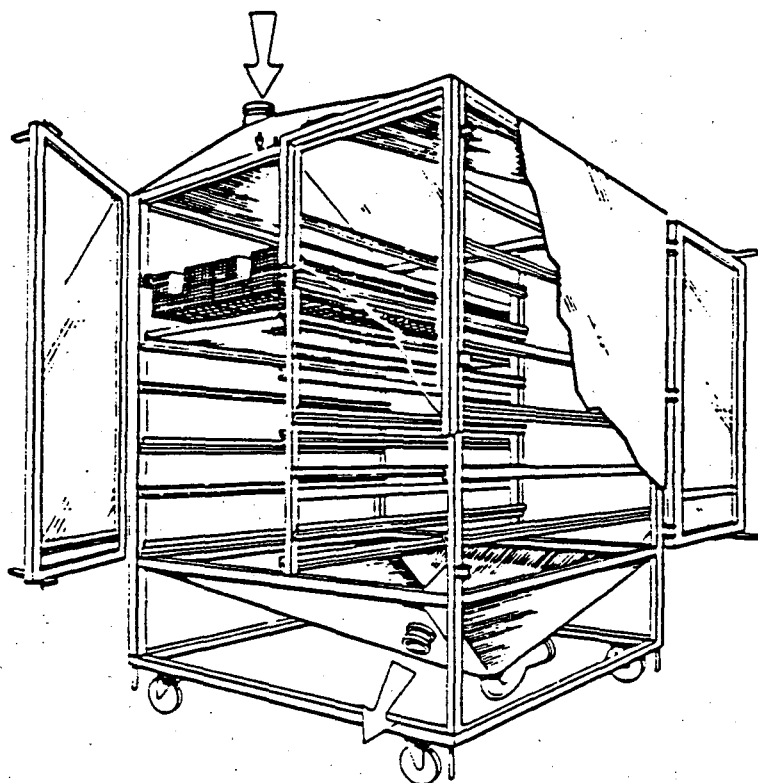
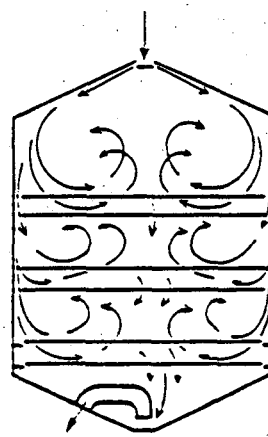

FIGURE 14b
Nitromethane Vapor Generation and Delivery System
for the 13-Week and 2-Year Studies



FRONT VIEW



SIDE VIEW

FIGURE J5
Nitromethane Inhalation Exposure Chamber

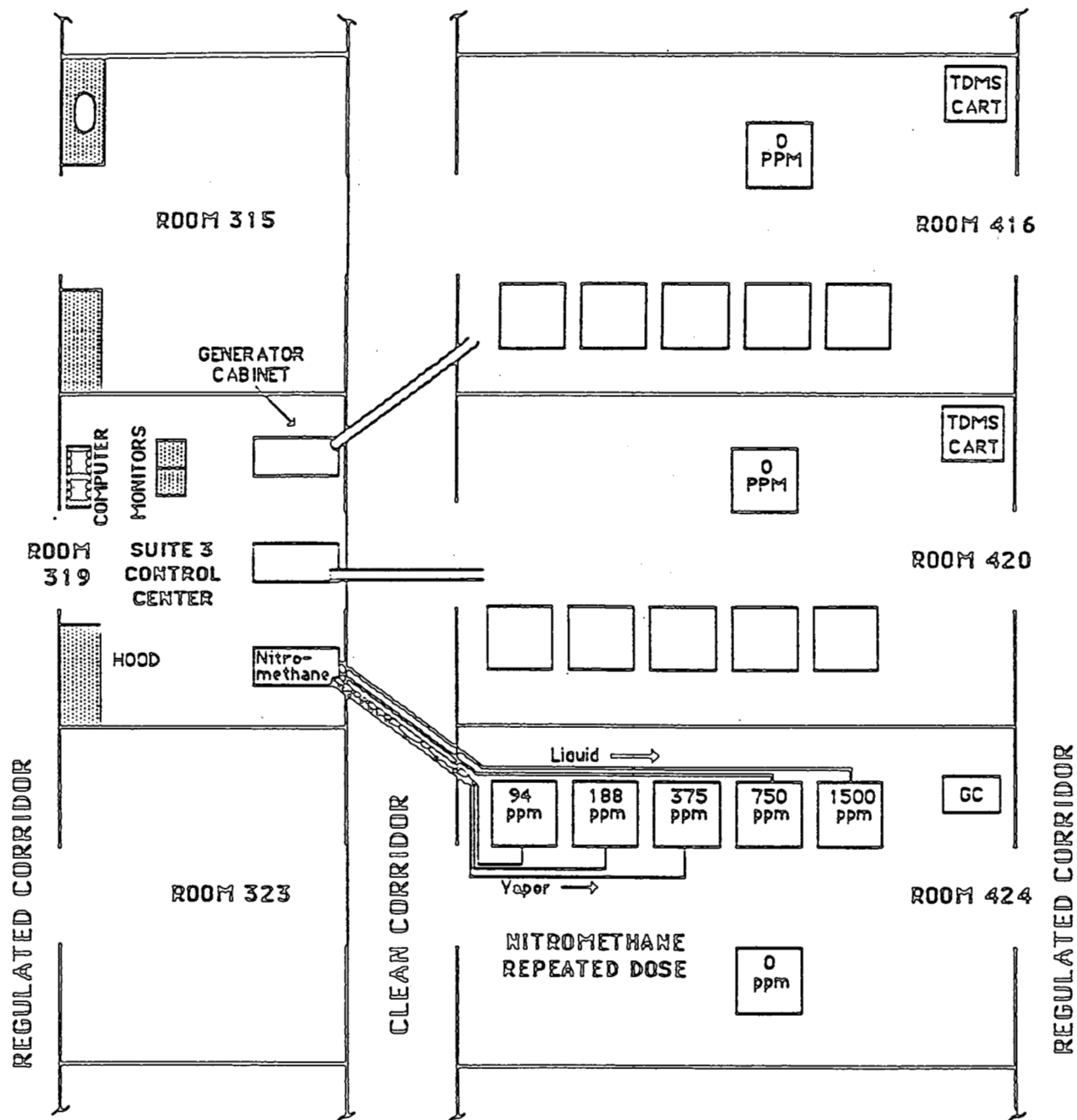

FIGURE J6a
Nitromethane Exposure Suite for the 16-Day Studies

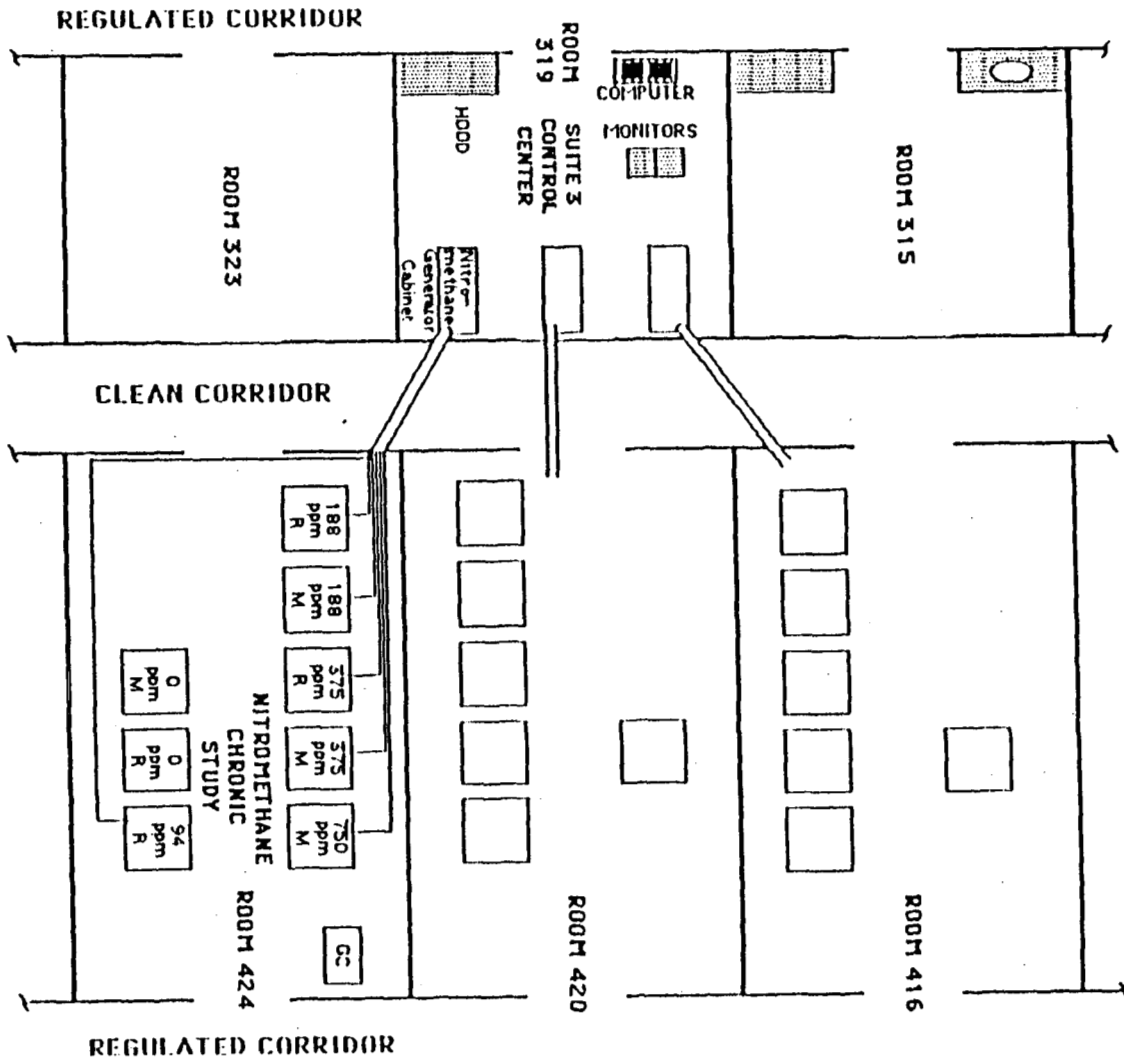

FIGURE J6b
Nitromethane Exposure Suite for the 13-Week and 2-Year Studies

TABLE J1
Summary of Chamber Concentrations in the 16-Day Inhalation Studies of Nitromethane

Target Concentration (ppm)	Total Number of Readings	Average Concentration ^a (ppm)
Rat Chambers		
94	95	94 ± 3
188	97	187 ± 6
375	92	377 ± 10
750	92	752 ± 34
1,500	90	1,510 ± 30
Mouse Chambers		
94	97	94 ± 3
188	100	186 ± 7
375	94	377 ± 10
750	94	750 ± 25
1,500	92	1,510 ± 31

^a Mean ± standard deviation

TABLE J2
Summary of Chamber Concentrations in the 13-Week Inhalation Studies of Nitromethane

Target Concentration (ppm)	Total Number of Readings	Average Concentration ^a (ppm)
Rat Chambers		
94	974	94 ± 6
188	938	187 ± 10
375	951	373 ± 19
750	971	748 ± 37
1,500	969	1,500 ± 58
Mouse Chambers		
94	988	93.6 ± 5.5
188	951	187 ± 10
375	963	373 ± 19
750	984	748 ± 37
1,500	982	1,500 ± 58

^a Mean ± standard deviation

TABLE J3
Summary of Chamber Concentrations in the 2-Year Inhalation Studies of Nitromethane

Target Concentration (ppm)	Total Number of Readings	Average Concentration ^a (ppm)
Rat Chambers		
94	5,791	94 ± 4
188	5,775	188 ± 7
375	5,575	375 ± 10
Mouse Chambers		
188	5,543	189 ± 5
375	5,623	376 ± 11
750	5,672	753 ± 18

^a Mean ± standard deviation

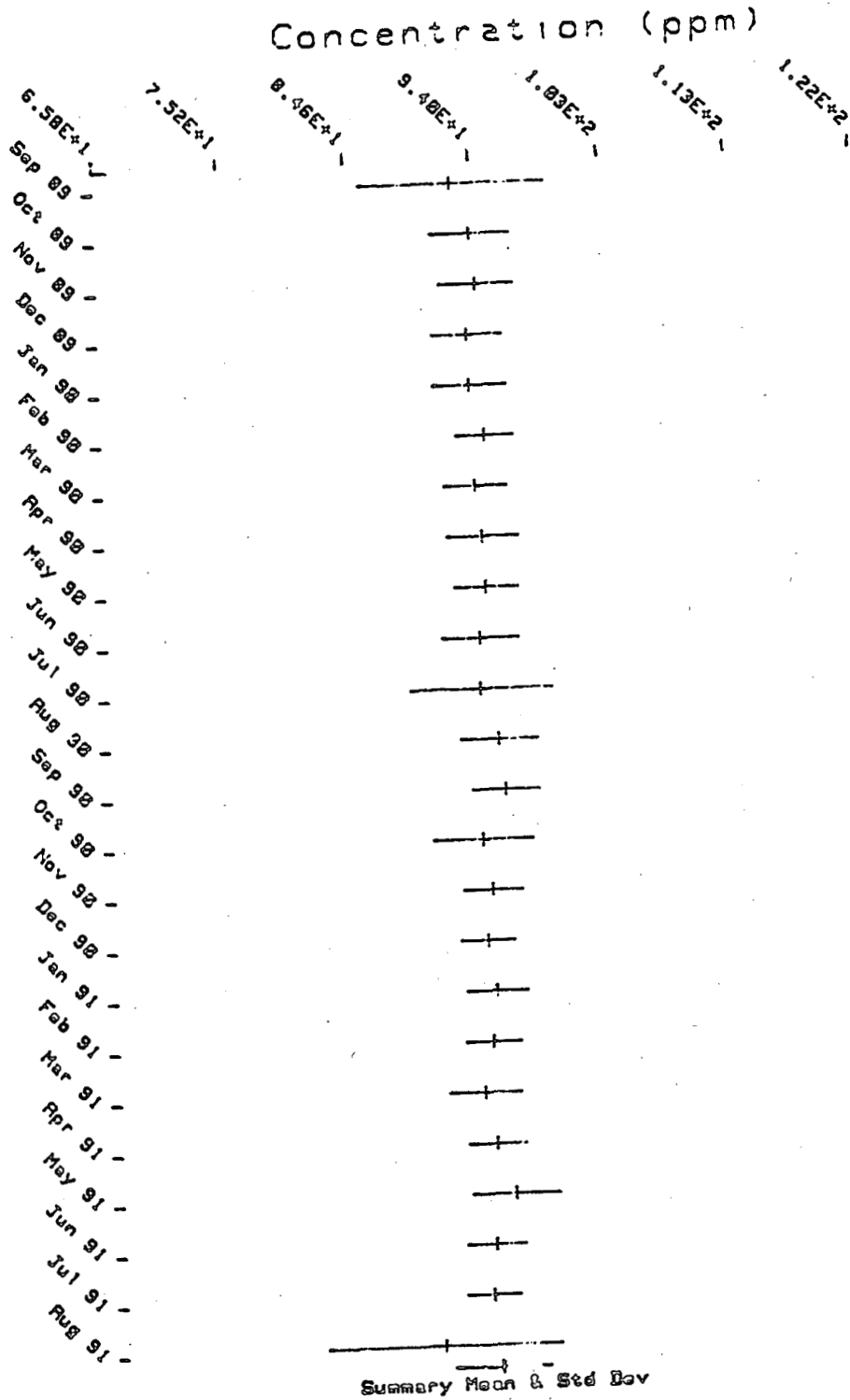

FIGURE J7
 Monthly Mean Concentration and Standard Deviation in the 94 ppm
 Rat Exposure Chamber in the 2-Year Inhalation Study of Nitromethane

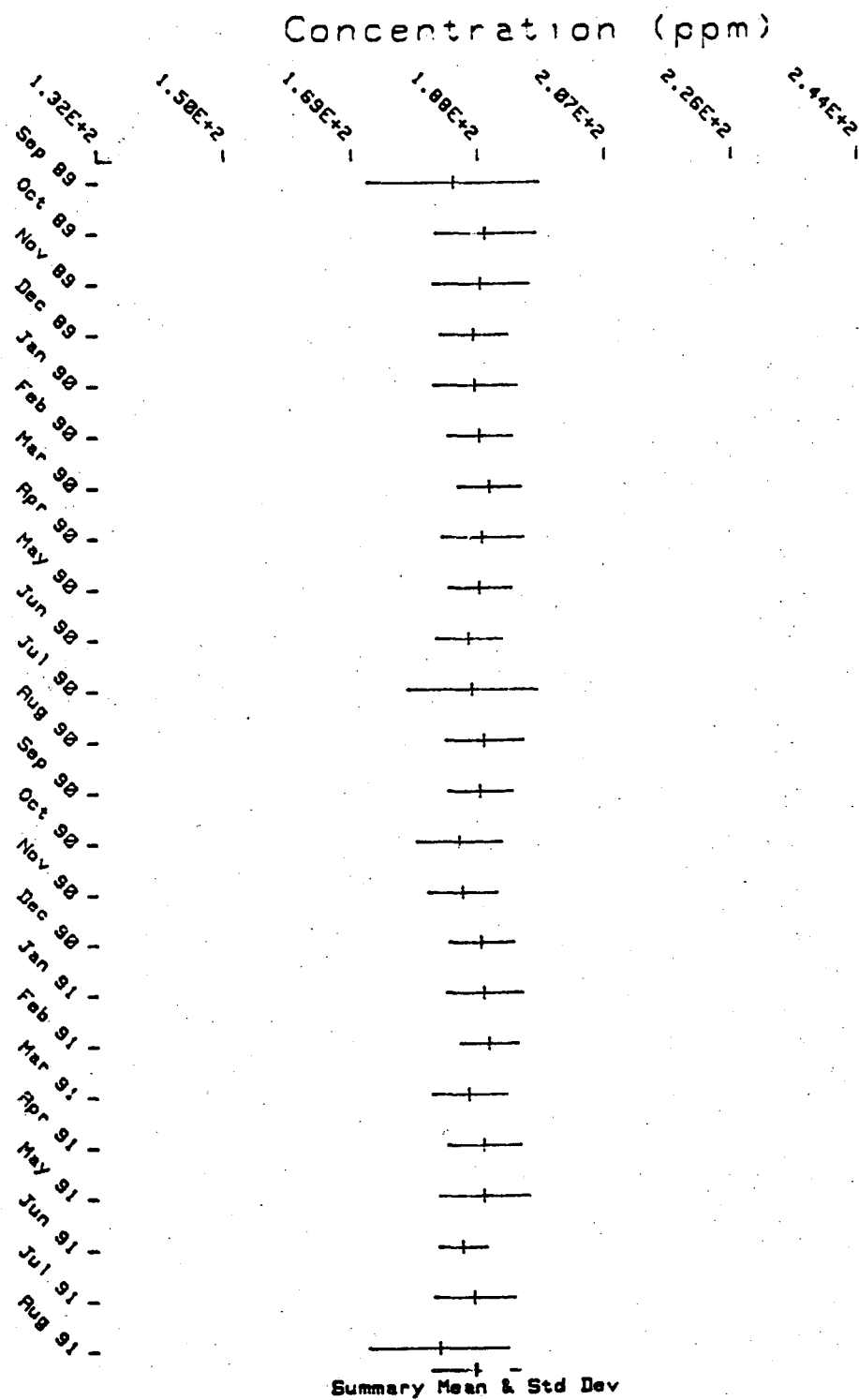

FIGURE J8
Monthly Mean Concentration and Standard Deviation in the 188 ppm
Rat Exposure Chamber in the 2-Year Inhalation Study of Nitromethane

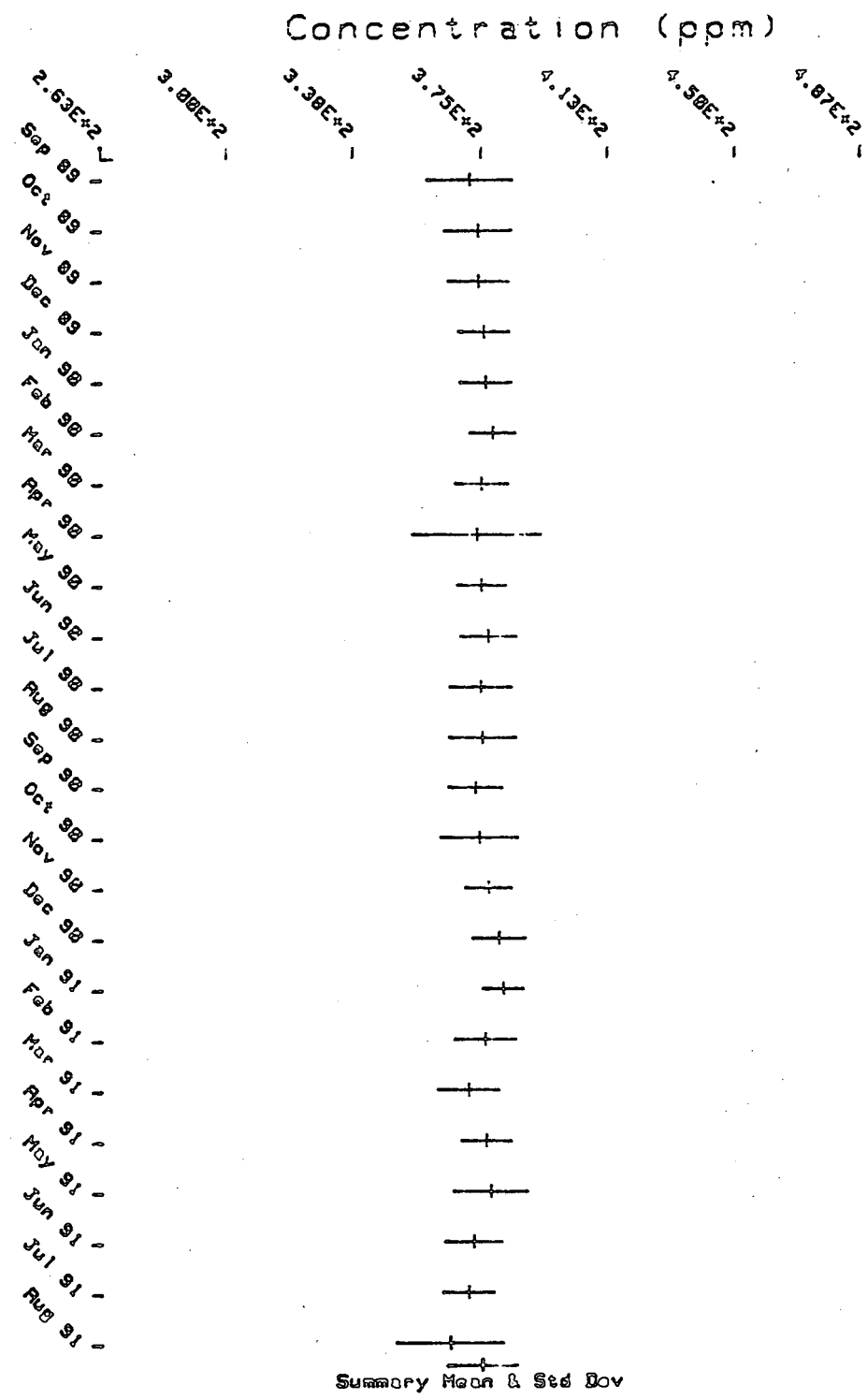

FIGURE J9
 Monthly Mean Concentration and Standard Deviation in the 375 ppm
 Rat Exposure Chamber in the 2-Year Inhalation Study of Nitromethane

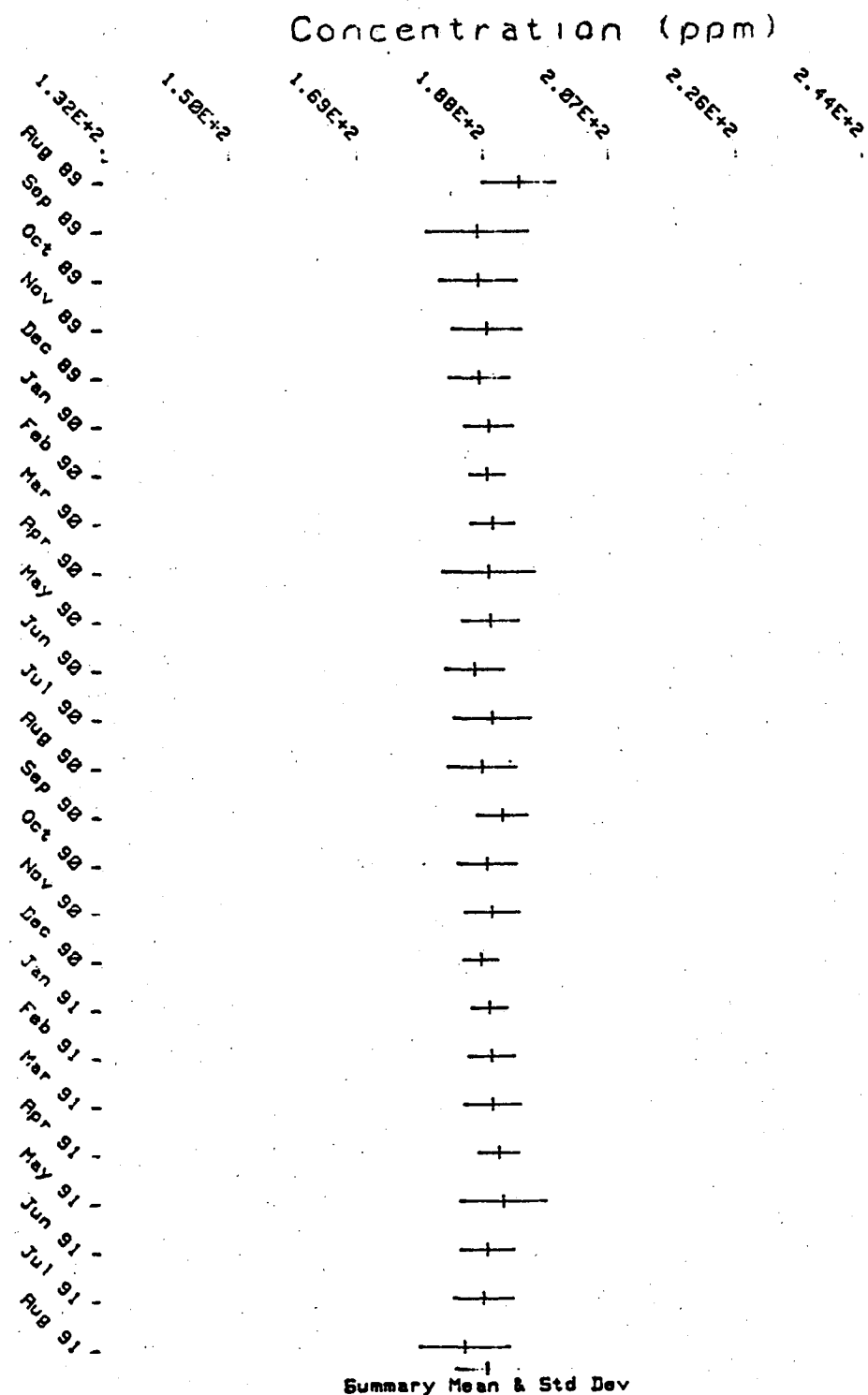

FIGURE J10
Monthly Mean Concentration and Standard Deviation in the 188 ppm
Mouse Exposure Chamber in the 2-Year Inhalation Study of Nitromethane

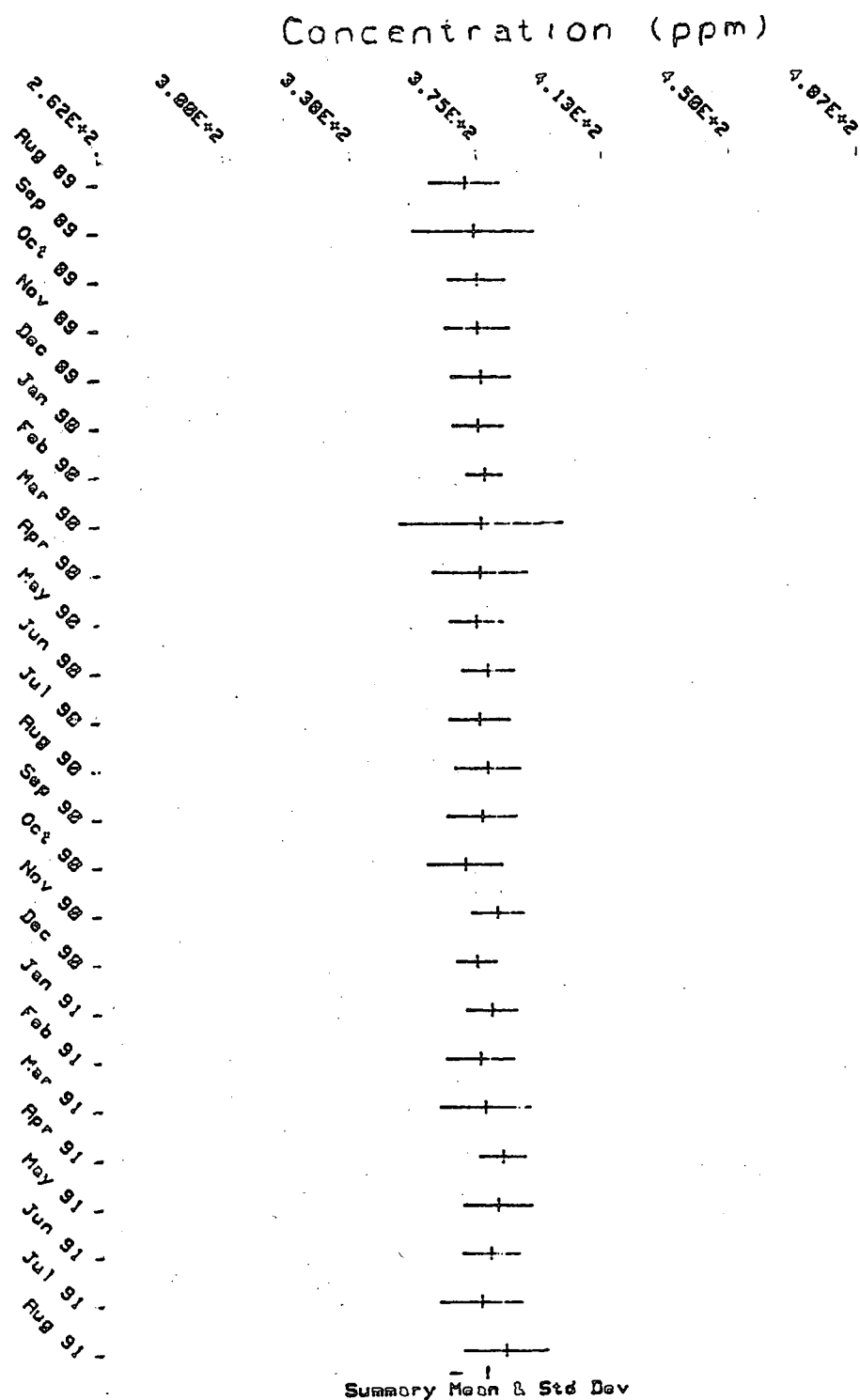

FIGURE J11
 Monthly Mean Concentration and Standard Deviation in the 375 ppm
 Mouse Exposure Chamber in the 2-Year Inhalation Study of Nitromethane

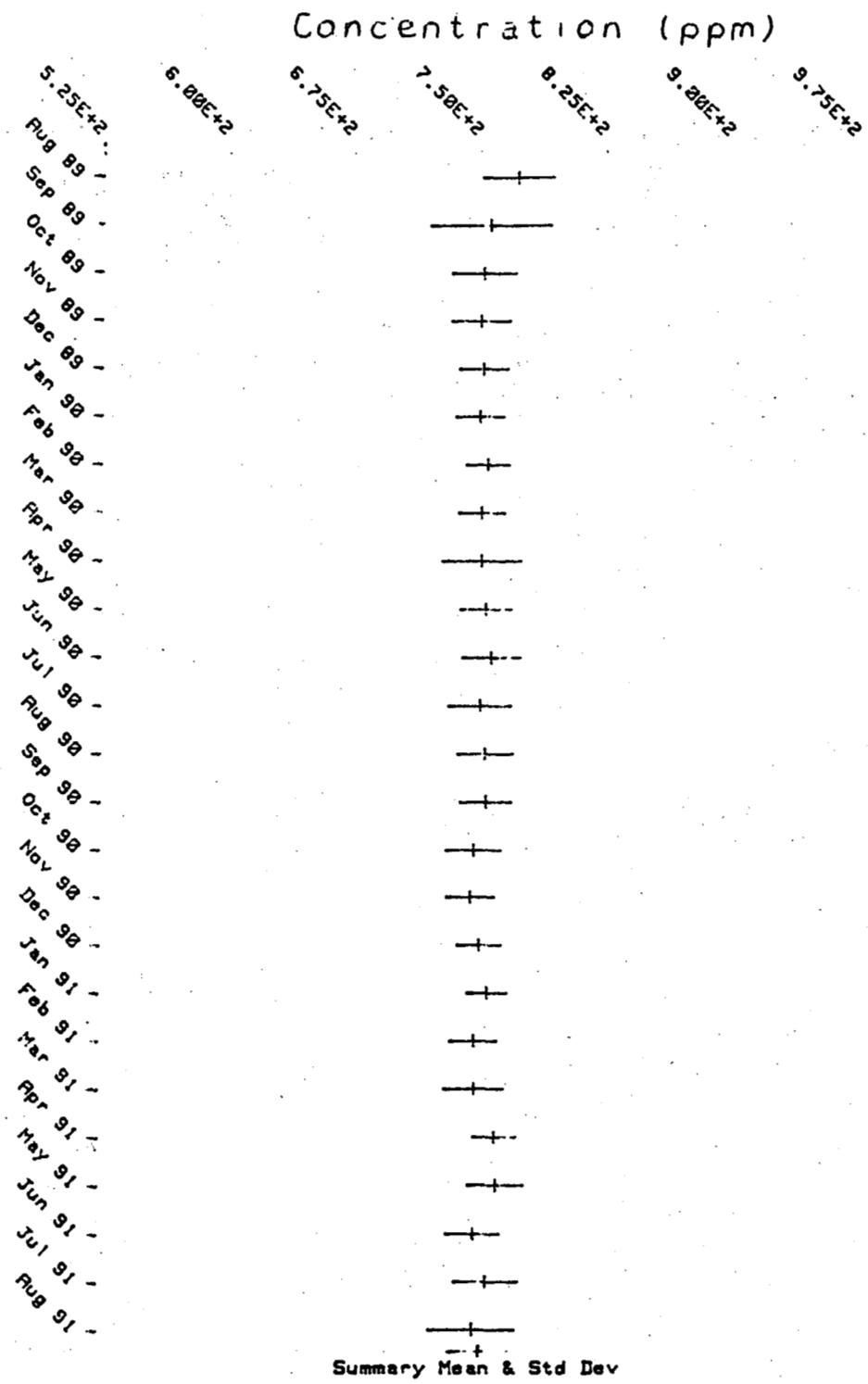

FIGURE J12
Monthly Mean Concentration and Standard Deviation in the 750 ppm
Mouse Exposure Chamber in the 2-Year Inhalation Study of Nitromethane

APPENDIX K
INGREDIENTS, NUTRIENT COMPOSITION,
AND CONTAMINANT LEVELS
IN NIH-07 RAT AND MOUSE RATION

TABLE K1	Ingredients of NIH-07 Rat and Mouse Ration	278
TABLE K2	Vitamins and Minerals in NIH-07 Rat and Mouse Ration	278
TABLE K3	Nutrient Composition of NIH-07 Rat and Mouse Ration	279
TABLE K4	Contaminant Levels in NIH-07 Rat and Mouse Ration	280

TABLE K1
Ingredients of NIH-07 Rat and Mouse Ration^a

Ingredients ^b	Percent by Weight
Ground #2 yellow shelled corn	24.50
Ground hard winter wheat	23.00
Soybean meal (49% protein)	12.00
Fish meal (60% protein)	10.00
Wheat middlings	10.00
Dried skim milk	5.00
Alfalfa meal (dehydrated, 17% protein)	4.00
Corn gluten meal (60% protein)	3.00
Soy oil	2.50
Dried brewer's yeast	2.00
Dry molasses	1.50
Dicalcium phosphate	1.25
Ground limestone	0.50
Salt	0.50
Premixes (vitamin and mineral)	0.25

^a NCI, 1976; NIH, 1978

^b Ingredients were ground to pass through a U.S. Standard Screen No. 16 before being mixed.

TABLE K2
Vitamins and Minerals in NIH-07 Rat and Mouse Ration^a

	Amount	Source
Vitamins		
A	5,500,000 IU	Stabilized vitamin A palmitate or acetate
D ₃	4,600,000 IU	D-activated animal sterol
K ₃	2.8 g	Menadione
<i>d</i> - α -Tocopheryl acetate	20,000 IU	
Choline	560.0 g	Choline chloride
Folic acid	2.2 g	
Niacin	30.0 g	
<i>d</i> -Pantothenic acid	18.0 g	<i>d</i> -Calcium pantothenate
Riboflavin	3.4 g	
Thiamine	10.0 g	Thiamine mononitrate
B ₁₂	4,000 μ g	
Pyridoxine	1.7 g	Pyridoxine hydrochloride
Biotin	140.0 mg	<i>d</i> -Biotin
Minerals		
Iron	120.0 g	Iron sulfate
Manganese	60.0 g	Manganous oxide
Zinc	16.0 g	Zinc oxide
Copper	4.0 g	Copper sulfate
Iodine	1.4 g	Calcium iodate
Cobalt	0.4 g	Cobalt carbonate

^a Per ton (2,000 lb) of finished product

TABLE K3
Nutrient Composition of NIH-07 Rat and Mouse Ration

Nutrient	Mean \pm Standard Deviation	Range	Number of Samples
Protein (% by weight)	23.29 \pm 0.52	22.2 — 24.0	25
Crude fat (% by weight)	5.27 \pm 0.14	5.00 — 5.60	25
Crude fiber (% by weight)	3.57 \pm 0.41	2.60 — 4.30	25
Ash (% by weight)	6.38 \pm 0.16	6.11 — 6.63	25
Amino Acids (% of total diet)			
Arginine	1.280 \pm 0.083	1.110 — 1.390	11
Cystine	0.308 \pm 0.071	0.181 — 0.400	11
Glycine	1.158 \pm 0.048	1.060 — 1.220	11
Histidine	0.584 \pm 0.027	0.531 — 0.630	11
Isoleucine	0.917 \pm 0.033	0.867 — 0.965	11
Leucine	1.975 \pm 0.051	1.850 — 2.040	11
Lysine	1.274 \pm 0.049	1.200 — 1.370	11
Methionine	0.437 \pm 0.109	0.306 — 0.699	11
Phenylalanine	0.999 \pm 0.120	0.665 — 1.110	11
Threonine	0.904 \pm 0.058	0.824 — 0.985	11
Tryptophan	0.218 \pm 0.153	0.107 — 0.671	11
Tyrosine	0.685 \pm 0.094	0.564 — 0.794	11
Valine	1.086 \pm 0.055	0.962 — 1.170	11
Essential Fatty Acids (% of total diet)			
Linoleic	2.407 \pm 0.227	1.830 — 2.570	10
Linolenic	0.259 \pm 0.065	0.100 — 0.320	10
Vitamins			
Vitamin A (IU/kg)	7,009 \pm 2,131	4,180 — 12,140	25
Vitamin D (IU/kg)	4,450 \pm 1,382	3,000 — 6,300	4
α -Tocopherol (ppm)	36.12 \pm 9.15	22.5 — 48.9	10
Thiamine (ppm)	18.72 \pm 2.42	15.0 — 28.0	25
Riboflavin (ppm)	7.83 \pm 0.92	6.10 — 9.00	11
Niacin (ppm)	98.64 \pm 25.5	65.0 — 150.0	10
Pantothenic acid (ppm)	30.55 \pm 3.52	23.0 — 34.6	11
Pyridoxine (ppm)	9.11 \pm 2.53	5.60 — 14.0	11
Folic acid (ppm)	2.46 \pm 0.63	1.80 — 3.70	11
Biotin (ppm)	0.268 \pm 0.047	0.190 — 0.354	11
Vitamin B ₁₂ (ppb)	40.5 \pm 19.1	10.6 — 65.0	11
Choline (ppm)	2,991 \pm 382	2,300 — 3,430	10
Minerals			
Calcium (%)	1.18 \pm 0.10	1.00 — 1.49	25
Phosphorus (%)	0.93 \pm 0.04	0.85 — 1.00	25
Potassium (%)	0.886 \pm 0.063	0.772 — 0.971	9
Chloride (%)	0.529 \pm 0.087	0.380 — 0.635	9
Sodium (%)	0.316 \pm 0.033	0.258 — 0.371	11
Magnesium (%)	0.166 \pm 0.010	0.148 — 0.181	11
Sulfur (%)	0.272 \pm 0.059	0.208 — 0.420	10
Iron (ppm)	350.5 \pm 87.3	255.0 — 523.0	11
Manganese (ppm)	92.48 \pm 5.14	81.7 — 99.4	11
Zinc (ppm)	59.3 \pm 10.2	46.1 — 81.6	11
Copper (ppm)	11.81 \pm 2.50	8.09 — 15.4	11
Iodine (ppm)	3.54 \pm 1.19	1.52 — 5.83	10
Chromium (ppm)	1.66 \pm 0.46	0.85 — 2.09	11
Cobalt (ppm)	0.76 \pm 0.23	0.49 — 1.15	7

TABLE K4
Contaminant Levels in NIH-07 Rat and Mouse Ration^a

	Mean \pm Standard Deviation ^b	Range	Number of Samples
Contaminants			
Arsenic (ppm)	0.36 \pm 0.18	0.10 — 0.70	25
Cadmium (ppm)	0.08 \pm 0.05	0.05 — 0.20	25
Lead (ppm)	0.28 \pm 0.23	0.10 — 1.00	25
Mercury (ppm)	0.03 \pm 0.01	0.02 — 0.50	25
Selenium (ppm)	0.36 \pm 0.12	0.05 — 0.60	25
Aflatoxins (ppm) ^c	<5.0		24
Nitrate nitrogen (ppm) ^d	14.35 \pm 4.41	5.70 — 21.0	25
Nitrite nitrogen (ppm) ^d	0.22 \pm 0.18	0.10 — 0.70	25
BHA (ppm) ^e	1.88 \pm 1.94	1.00 — 10.0	25
BHT (ppm) ^e	1.60 \pm 1.58	1.0 — 8.00	25
Aerobic plate count (CFU/g)	40,360 \pm 25,193	4,100 — 110,000	25
Coliform (MPN/g)	<3		25
<i>Escherichia coli</i> (MPN/g)	<3		25
<i>Salmonella</i> (MPN/g)	Negative		25
Total nitrosoamines (ppb) ^f	7.78 \pm 2.63	4.80 — 16.50	25
<i>N</i> -Nitrosodimethylamine (ppb) ^f	5.81 \pm 1.98	3.80 — 13.0	25
<i>N</i> -Nitrosopyrrolidine (ppb) ^f	1.97 \pm 1.13	1.00 — 4.30	25
Pesticides (ppm)			
α -BHC	<0.01		25
β -BHC	<0.02		25
γ -BHC	<0.01		25
δ -BHC	<0.01		25
Heptachlor	<0.01		25
Aldrin	<0.01		25
Heptachlor epoxide	<0.01		25
DDE	<0.01		25
DDD	<0.01		25
DDT	<0.01		25
HCB	<0.01		25
Mirex	<0.01		25
Methoxychlor	<0.05		25
Dieldrin	<0.01		25
Endrin	<0.01		25
Telodrin	<0.01		25
Chlordane	<0.05		25
Toxaphene	<0.10		25
Estimated PCBs	<0.20		25
Ronnel	<0.01		25
Ethion	<0.02		25
Trithion	<0.05		25
Diazinon	<0.10		25
Methyl parathion	<0.02		25
Ethyl parathion	<0.02		25
Malathion	0.27 \pm 0.27	0.05 — 1.00	25
Endosulfan I	<0.01		25
Endosulfan II	<0.01		25
Endosulfan sulfate	<0.03		25

^a CFU = colony-forming units; MPN = most probable number; BHC = hexachlorocyclohexane or benzene hexachloride

^b For values less than the limit of detection, the detection limit is given as the mean.

^c No aflatoxin measurement was recorded for the lot milled on 2 October 1989.

^d Sources of contamination: alfalfa, grains, and fish meal

^e Sources of contamination: soy oil and fish meal

^f All values were corrected for percent recovery.

APPENDIX L SENTINEL ANIMAL PROGRAM

METHODS	282
RESULTS	284

SENTINEL ANIMAL PROGRAM

METHODS

Rodents used in the Carcinogenesis Program of the National Toxicology Program are produced in optimally clean facilities to eliminate potential pathogens that may affect study results. The Sentinel Animal Program is part of the periodic monitoring of animal health that occurs during the toxicologic evaluation of chemical compounds. Under this program, the disease state of the rodents is monitored via serology on sera from extra (sentinel) animals in the study rooms. These animals and the study animals are all subject to identical environmental conditions. The sentinel animals come from the same production source and weanling groups as the animals used for the studies of chemical compounds.

Serum samples were collected from randomly selected rats and mice during the 13-week and 2-year studies. Blood from each animal was collected and allowed to clot, and the serum was separated. The samples were processed appropriately and sent to Microbiological Associates, Inc. (Bethesda, MD), for determination of antibody titers. The laboratory serology methods and viral agents for which testing was performed are tabulated below; the times at which blood was collected during the studies are also listed.

<u>Method and Test</u>	<u>Time of Analysis</u>
RATS	
13-Week Study	
ELISA	
PVM (pneumonia virus of mice)	13 weeks
RCV/SDA (rat coronavirus/sialodacryoadenitis virus)	13 weeks
Sendai	13 weeks
Hemagglutination Inhibition	
H-1 (Toolan's H-1 virus)	13 weeks
KRV (Kilham rat virus)	13 weeks
2-Year Study	
ELISA	
<i>Mycoplasma arthritidis</i>	24 months
<i>Mycoplasma pulmonis</i>	24 months
PVM	6, 12, 18, and 24 months
RCV/SDA	6, 12, 18, and 24 months
Sendai	6, 12, 18, and 24 months
Immunofluorescence Assay	
RCV/SDA	12 months
Hemagglutination Inhibition	
H-1	6, 12, 18, and 24 months
KRV	6, 12, 18, and 24 months

MICE

13-Week Study

ELISA

Ectromelia virus	13 weeks
GDVII (mouse encephalomyelitis virus)	13 weeks
MVM (minute virus of mice)	13 weeks
Mouse adenoma virus	13 weeks
MHV (mouse hepatitis virus)	13 weeks
PVM	13 weeks
Reovirus 3	13 weeks
Sendai	13 weeks

Immunofluorescence Assay

EDIM (epizootic diarrhea of infant mice)	13 weeks
LCM (lymphocytic choriomeningitis virus)	13 weeks

Hemagglutination Inhibition

K (papovavirus)	13 weeks
Polyoma virus	13 weeks

2-Year Study

ELISA

Ectromelia virus	6, 12, 18, and 24 months
EDIM	12, 18, and 24 months
GDVII	6, 12, 18, and 24 months
LCM	6, 12, 18, and 24 months
Mouse adenoma virus	6 months
Mouse adenoma virus-FL	12, 18, and 24 months
MHV	6, 12, 18, and 24 months
<i>M. arthritidis</i>	18 and 24 months
<i>M. pulmonis</i>	18 and 24 months
PVM	6, 12, 18, and 24 months
Reovirus 3	6, 12, 18, and 24 months
Sendai	6, 12, 18, and 24 months

Immunofluorescence Assay

EDIM	6, 12, and 18 months
GDVII	24 months
MVM	6 and 12 months
Mouse adenoma virus-FL	24 months
MHV	12 months
Sendai	24 months

Hemagglutination Inhibition

K	6, 12, 18, and 24 months
MVM	18 and 24 months
Polyoma virus	6, 12, 18, and 24 months

RESULTS

One rat had a positive titer to *M. arthritidis* at the end of the 2-year study. Further evaluation of the serum positive for *M. arthritidis* by immunoblot and Western blot procedures indicated that the positive titer may have been due to cross reaction with antibodies of nonpathogenic *Mycoplasma* or other agents. Only a single sample was positive, and there were no clinical findings or histopathologic changes of *M. arthritidis* infection in the animal with the positive titer. Accordingly, the *M. arthritidis*-positive titer was considered to be a false positive.

**DEPARTMENT OF
HEALTH & HUMAN SERVICES**

Public Health Service
National Toxicology Program
Central Data Management
P.O. Box 12233, MD E1-02
Research Triangle Park, NC 27709

**SPECIAL FOURTH-CLASS RATE
POSTAGE AND FEES PAID
DHHS/NIH
Permit No. G-811**

**Official Business
Penalty for Private Use - \$300**

**NIH Publication No. 97-3377
February 1997**