



U.S. ARMY COMBAT CAPABILITIES DEVELOPMENT COMMAND – CHEMICAL BIOLOGICAL CENTER

Micro-Physiological Systems Applications for Predictive Toxicology

Tyler D.P. Goralski, Ph.D.
Research Biologist, Molecular Toxicology
Threat Agent Science Division

26 MAY 2022



The views expressed in this presentation are those of the author(s) and do not necessarily reflect the official policy of the Department of Defense, Department of the Army, U.S. Army Medical Department or the U.S. Government.

Use of trademarked name(s) does not imply endorsement by the U.S. Army but is intended only to assist in identification of a specific product.



WHY USE ORGANS-ON-A-CHIP?

Problem

- Establishing a physiologically relevant biomimetic human model that will accurately, reliably, timely, and economically represent human organ-organ interactions. Historically this work has been performed in traditional tissue culture and animal models which can be time consuming, costly, and lack physiological accuracy and precision.

Solution

- Micro-physiological systems (MPS) technology offers a high throughput process that offers advantages over both conventional *in vitro* and animal modeling in certain applications by supplying cutting-edge Organs-on-a-chip (OOC) that imitate human tissue-tissue interfaces, chemical and mechanical microenvironments specific to living human organs.

Goal

- Provide an ideal alternative and/or replacement to traditional tissue culture and animal models for a “human surrogate” toxicity and efficacy testing.



WHY USE ORGANS-ON-A-CHIP?

Problem ←

- Establishing a physiologically relevant biomimetic human model that will accurately, reliably, timely, and economically represent human organ-organ interactions. Historically this work has been performed in traditional tissue culture and animal models which can be time consuming, costly, and lack physiological accuracy and precision.

Solution

- Micro-physiological systems (MPS) technology offers a high throughput process that offers advantages over both conventional *in vitro* and animal modeling in certain applications by supplying cutting-edge Organs-on-a-chip (OOC) that imitate human tissue-tissue interfaces, chemical and mechanical microenvironments specific to living human organs.

Goal

- Provide an ideal alternative and/or replacement to traditional tissue culture and animal models for a “human surrogate” toxicity and efficacy testing.

Animal Model



Traditional Tissue Culture





WHY USE ORGANS-ON-A-CHIP?

Problem

- Establishing a physiologically relevant biomimetic human model that will accurately, reliably, timely, and economically represent human organ-organ interactions. Historically this work has been performed in traditional tissue culture and animal models which can be time consuming, costly, and lack physiological accuracy and precision.

Solution ←

- Micro-physiological systems (MPS) technology offers a high throughput process that offers advantages over both conventional *in vitro* and animal modeling in certain applications by supplying cutting-edge Organs-on-a-chip (OOC) that imitate human tissue-tissue interfaces, chemical and mechanical microenvironments specific to living human organs.

Goal

- Provide an ideal alternative and/or replacement to traditional tissue culture and animal models for a “human surrogate” toxicity and efficacy testing.

MicroPhysiological Systems

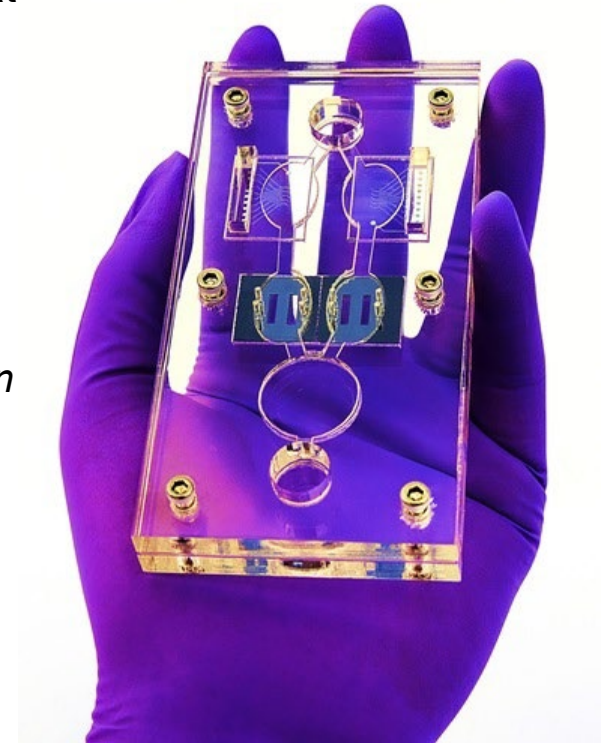



WHY USE ORGANS-ON-A-CHIP?

Problem

- Establishing a physiologically relevant biomimetic human model that will accurately, reliably, timely, and economically represent human organ-organ interactions. Historically this work has been performed in traditional tissue culture and animal models which can be time consuming, costly, and lack physiological accuracy and precision.

Solution

- Micro-physiological systems (MPS) technology offers a high throughput process that offers advantages over both conventional *in vitro* and animal modeling in certain applications by supplying cutting-edge Organs-on-a-chip (OOC) that imitate human tissue-tissue interfaces, chemical and mechanical microenvironments specific to living human organs.

Goal ←

- Provide an ideal alternative and/or replacement to traditional tissue culture and animal models for a “human surrogate” toxicity and efficacy testing.

Human Surrogate





FUNCTIONAL SYSTEMS FOR PREDICTIVE TOXICOLOGY AT THREAT AGENT SCIENCE



• Operational

- Cardiac (RTCA, organoids)
- Liver (2D, 3D, MPS)
- CNS (2D)
- Blood-Brain-Barrier (TW)
- Lung (2D, 3D)
- Dermal (3D)
- Lung (MPS)
- Kidney (MPS)

• In Development

- CNS (3D organoids)
- BBB (MPS)

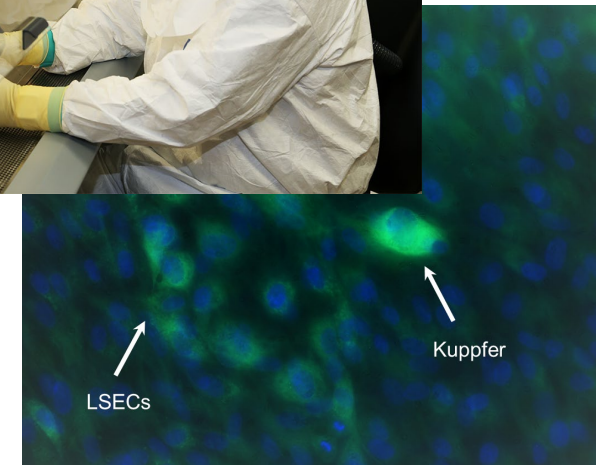
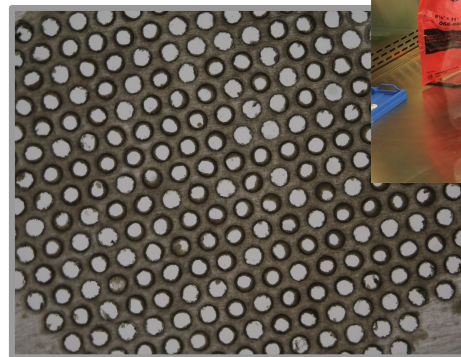
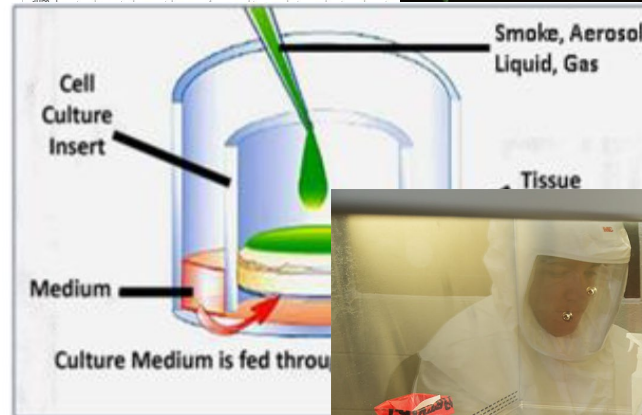
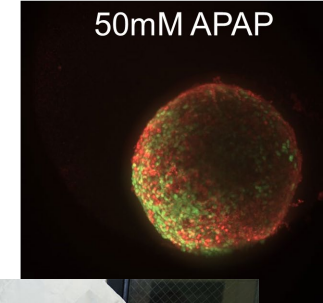
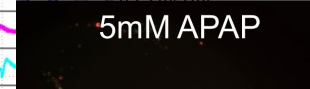
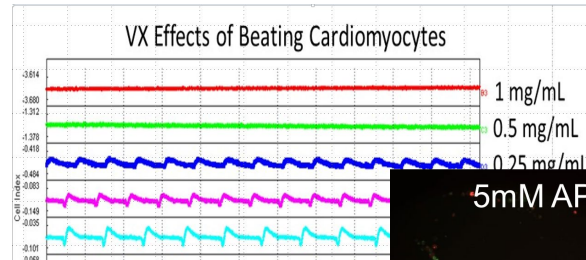

CURRENT ORGAN-ON-A-CHIP DESIGNS

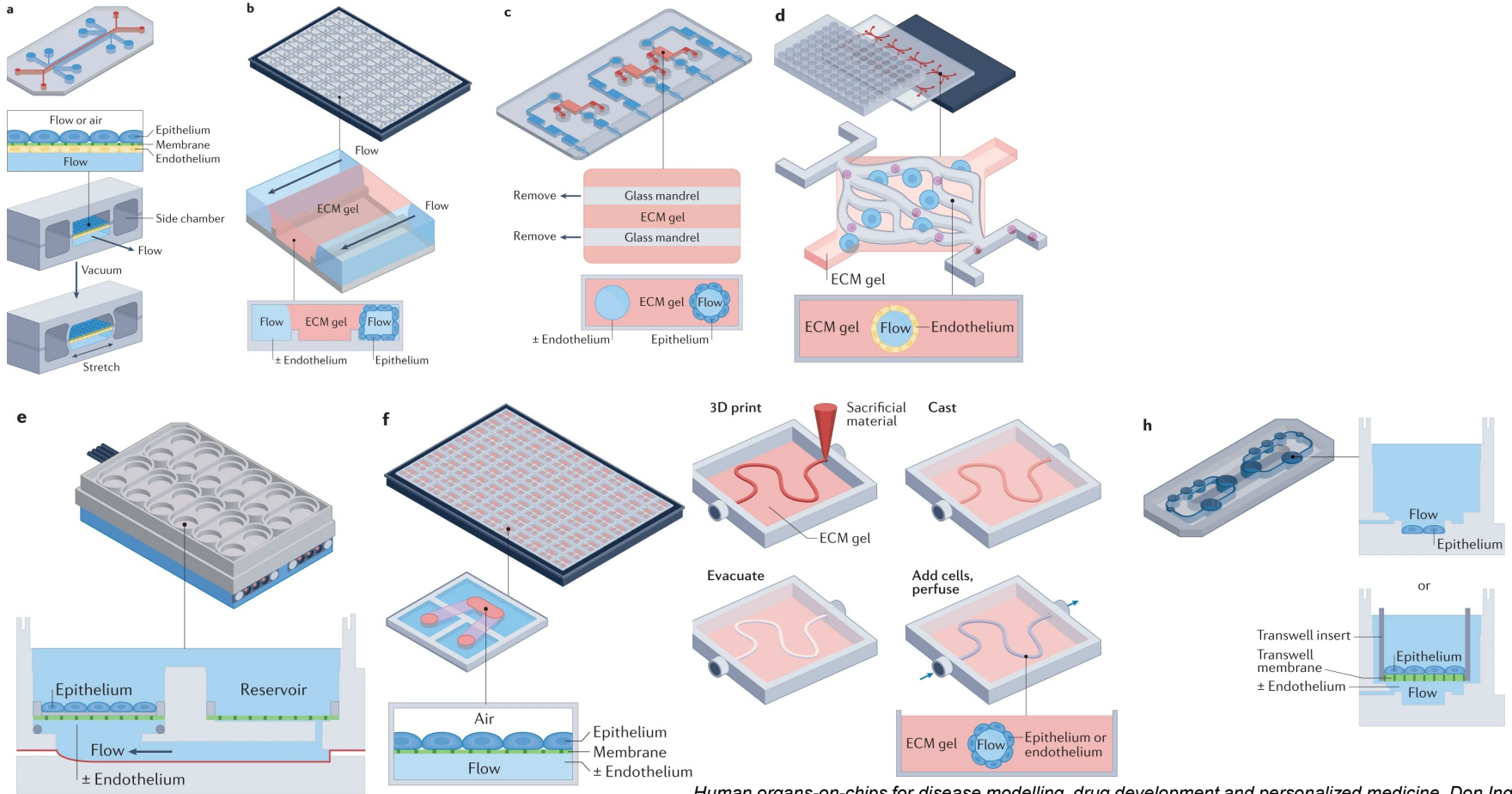

Human organs-on-chips for disease modelling, drug development and personalized medicine, Don Ingber.

CURRENT ORGAN-ON-A-CHIP DESIGNS

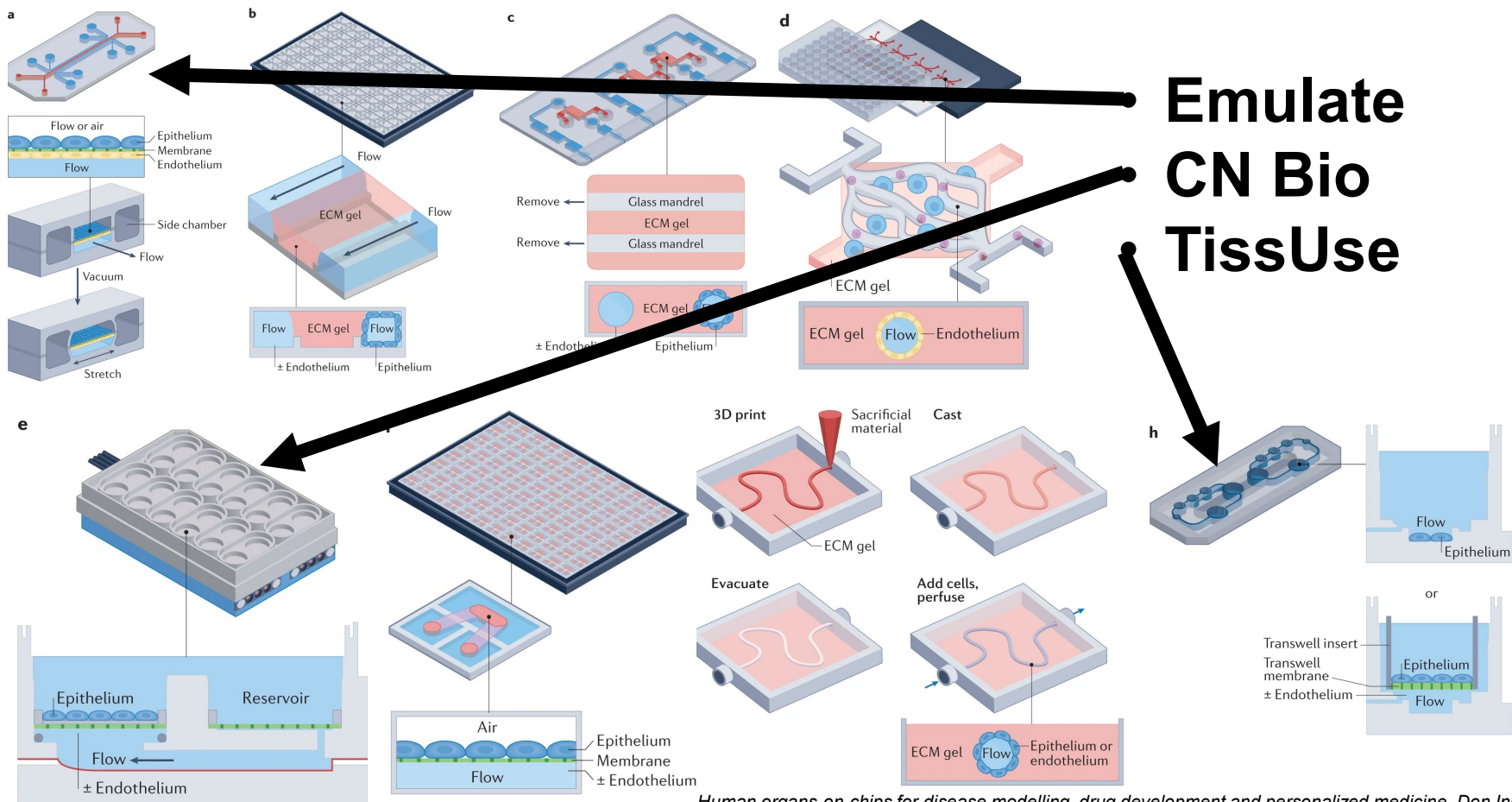

**Emulate
CN Bio
TissUse**

Human organs-on-chips for disease modelling, drug development and personalized medicine, Don Ingber.



CN BIO PHYSIOMIMIX

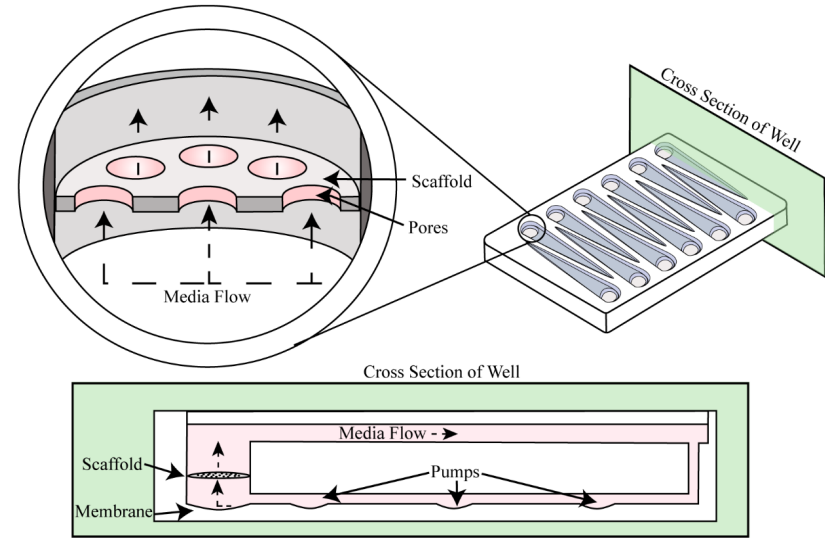
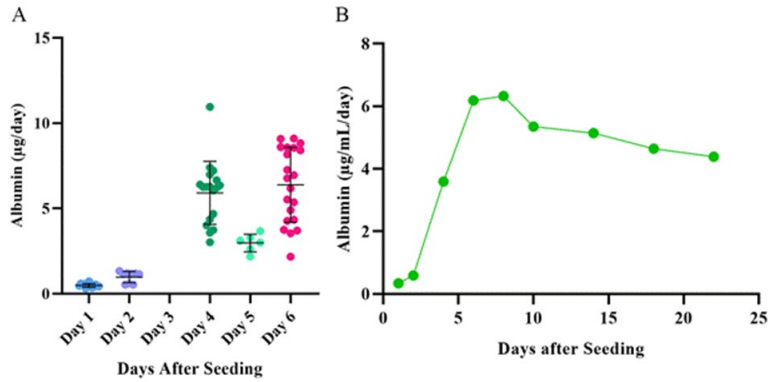
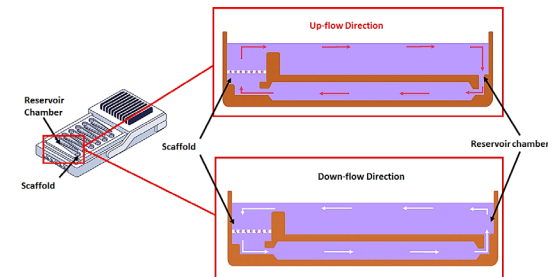

Figure 3. LC12 plate showing the scaffold and incubation media flow direction.



Figure 14. The PhysioMimix OOC microphysiological system. The controller supplies the pneumatic pressure and acts as a center for commands. The dock is where the system sits inside the incubator, delivering the pneumatic pressure. The drivers and plates are the mobile parts of the system where the cell culture takes place. Taken from CN-Bio IFU PhysioMimix System 000264





TISSUSE HUMIMMIC MOC SYSTEM



TissUse Chip3+:

- Size of a standard microscope slide, suitable for iPSC-derived cells, primary cells, 3D tissues and cell lines. **3 organ systems on 1 chip.**
- Uses on-chip micro-pump enabling pulsatile flow.

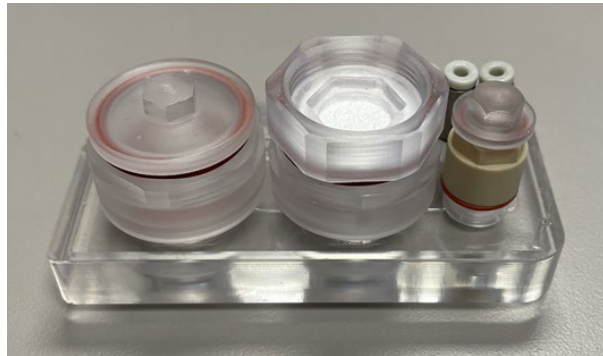

Current Effort:

- Expose lung, skin, and heart to 3 biological and 3 chemical agents. Lyse and analyze protein/metabolites after early exposure to identify physiological biomarkers for wearables.

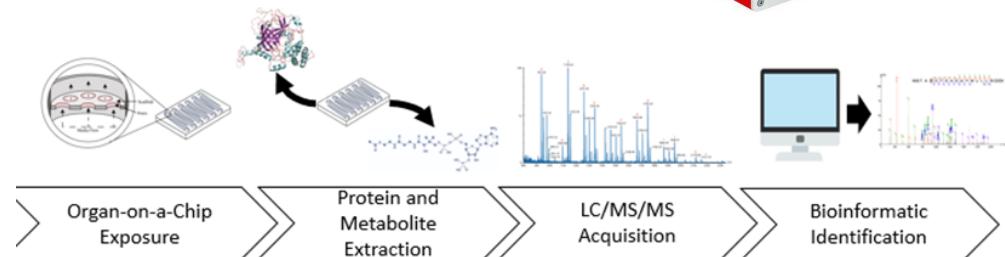

Analyses:

Proteomics/Transcriptomics – Intact proteoform and transcriptome analysis, Intelligent instrument acquisition, enriched data dependent acquisition, high-throughput/highly reproducible sample preparation techniques

Metabolomics – **Machine learning driven** feature detection, global metabolite system perturbation analysis, broad screening based on multiple chemometric profiles.



EMULATE ORGANS-ON-CHIPS

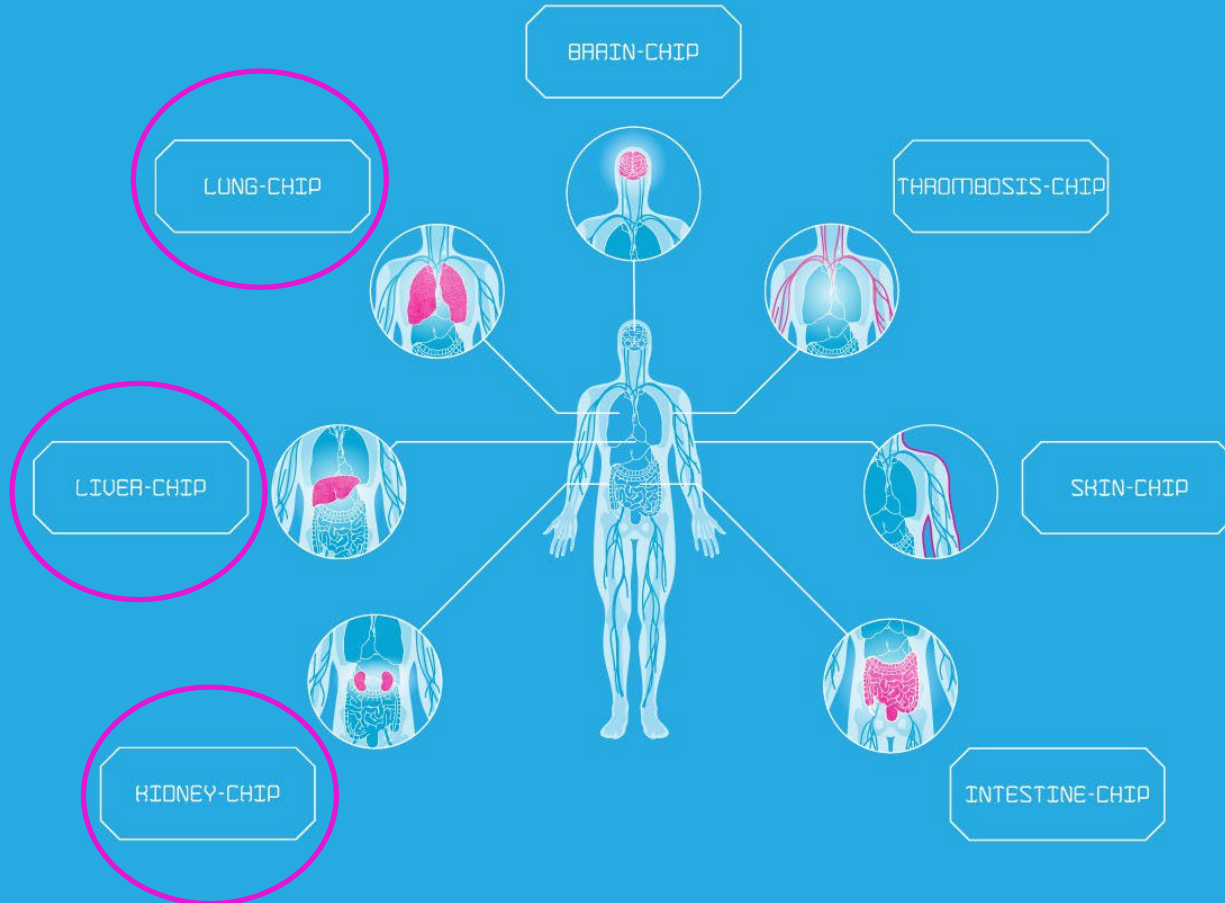



EMULATE S1 CHIP OVERVIEW



1. Epithelial Channel
2. Human Epithelial Cells
3. Vacuum Channel
4. Membrane
5. Human Endothelial Cells
6. Endothelial Channel

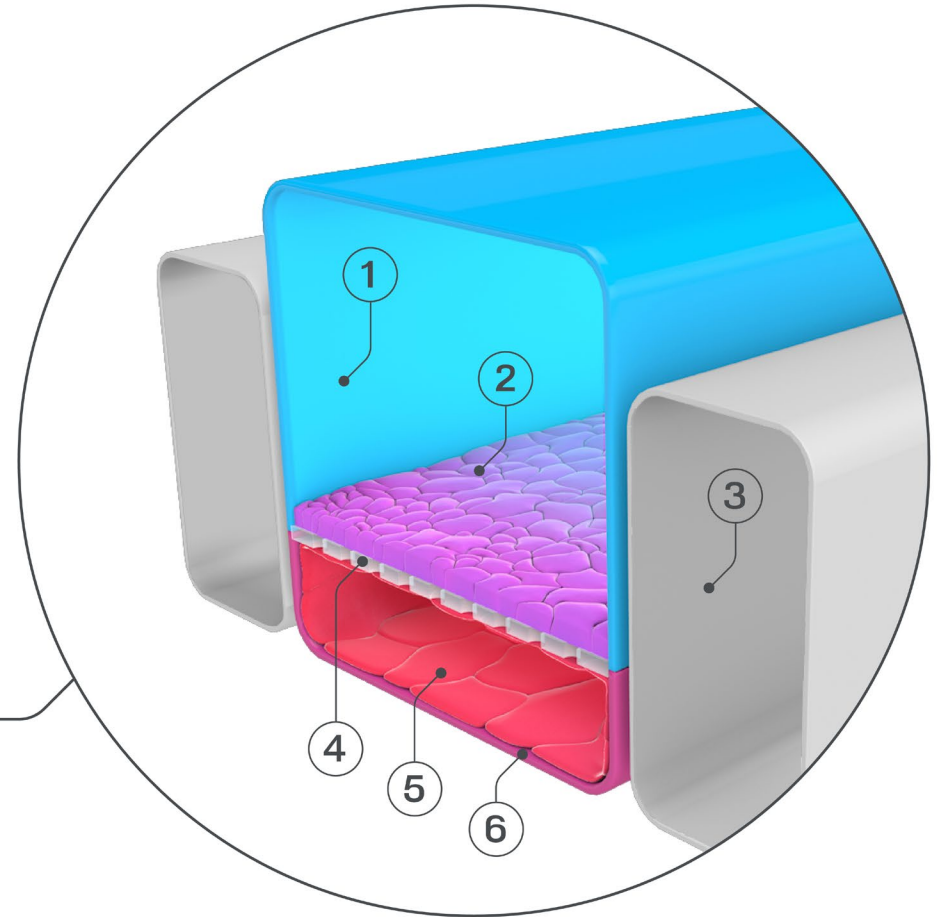
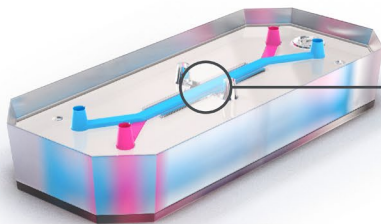

Emulate Inc.



EMULATE ZOË



- 1 Zoë supports up to 12 Organ-Chips.
- Automated flow of cell culture medium, which is set to a physiologically relevant rate.
- Option for mechanical stretch to recreate the forces a human organ would experience.





EMULATE ORB



- One Orb can power up to 4 Zoës
- The Orb provides gas, air and power required by Zoë to maintain flow, appropriate gas mixture and stretch to the chips.
- Monitors the system and makes user aware of issues if they arise.

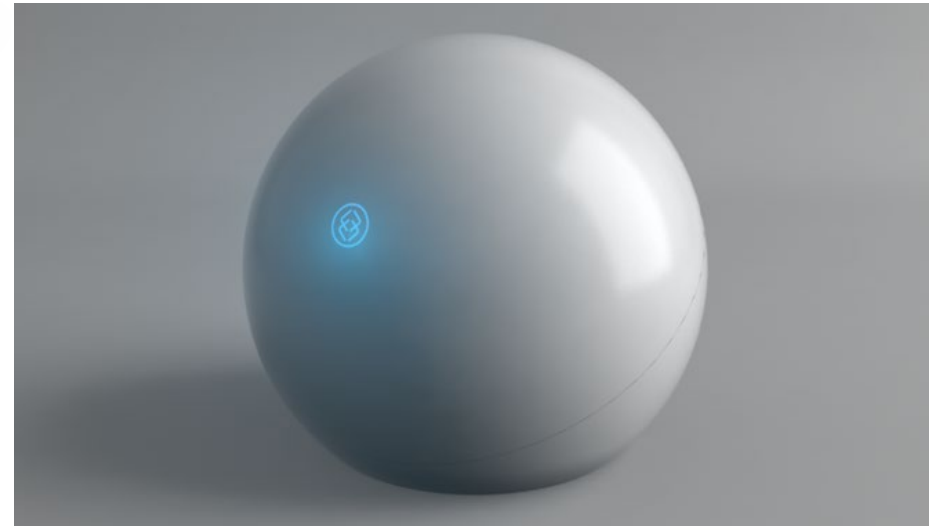



Effects of VX on Hepatic Function using Global Multiomic Analysis

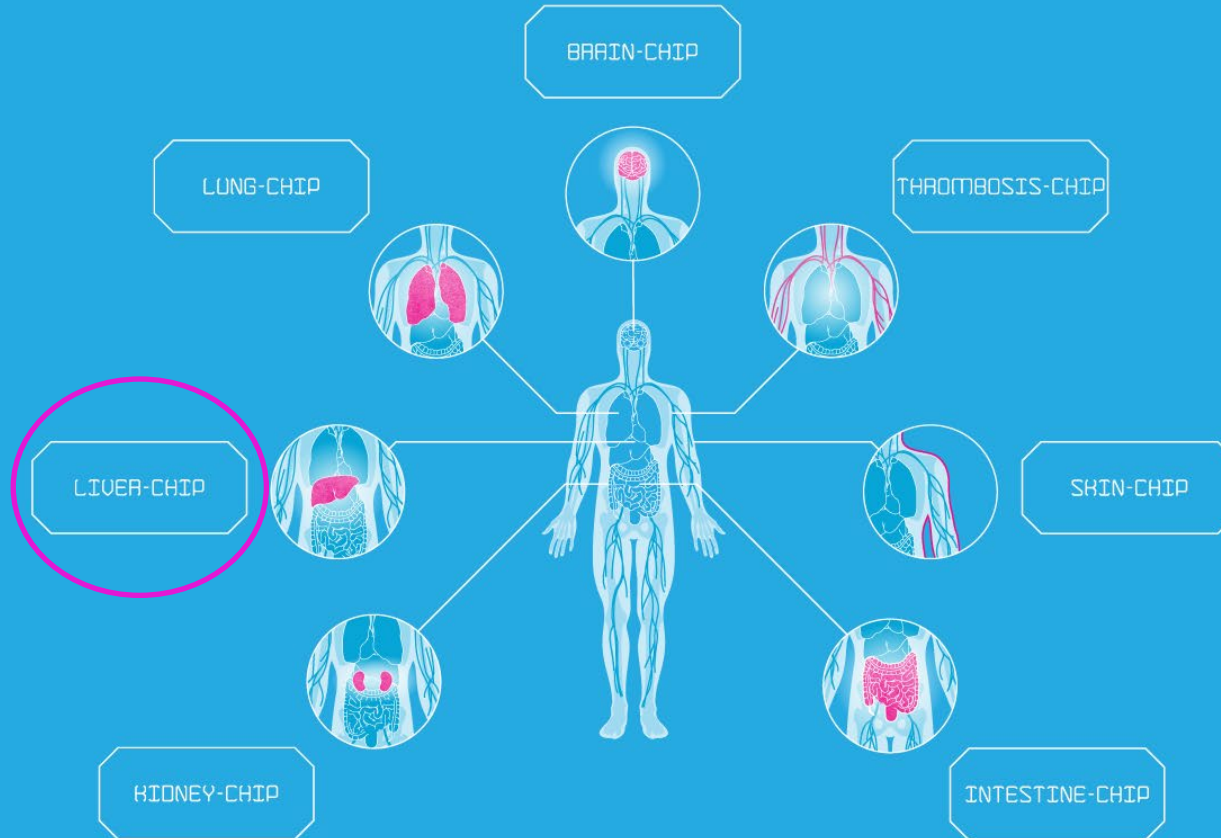



LIVER CHIP: BUILDING TISSUE COMPLEXITY

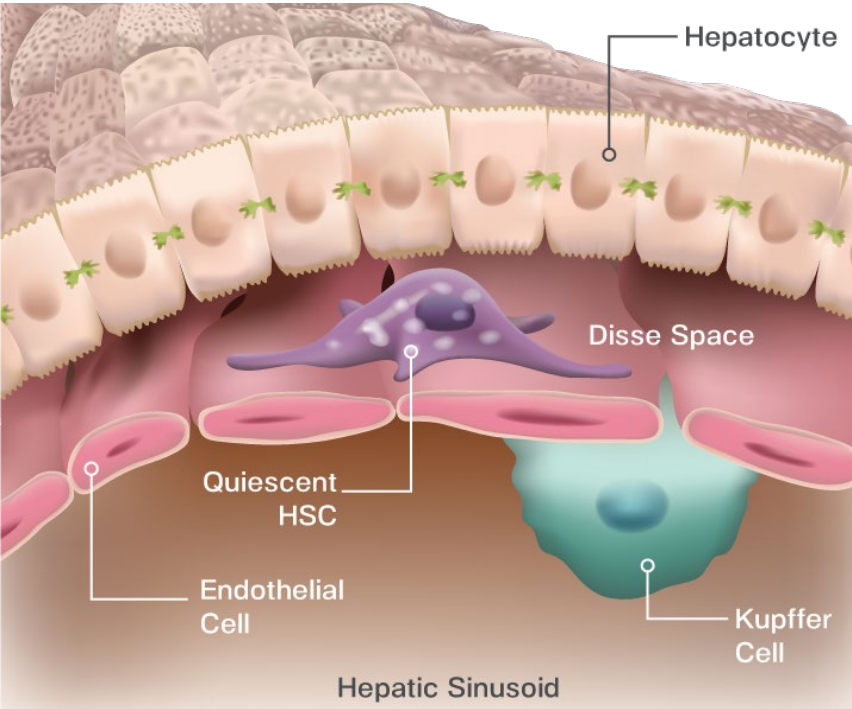

J Clin Invest. 2007

Co-culture
Hepatocytes + Liver Sinusoidal
Endothelial Cells (LSECs)



Tri-culture
Hepatocytes + LSECs
+ Kupffer cells



Quad-culture
Hepatocytes + LSECs
+ Kupffer cells + Stellate cells

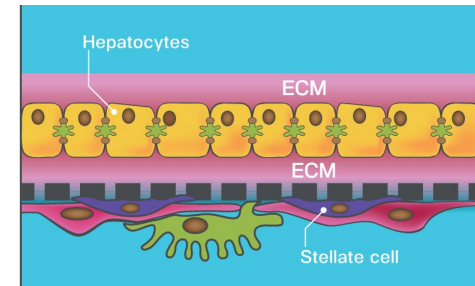
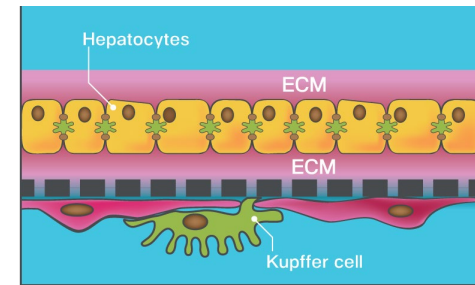
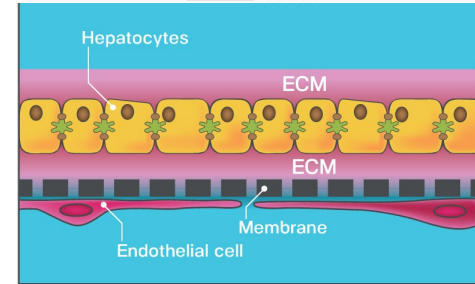

Cell Type	Number of Cells/Chip
Hepatocyte	75,000
LSEC	60,000
Kupffer	2,000
Stellate	10,000



METABOLOMIC AND PROTEOMIC VX ANALYSIS IN LIVER



Samples were acquired utilizing four instrument methods for maximum coverage of identified features

- Hilic and Reverse Phase Chromatography both in Positive and Negative Polarity with Data Dependent Acquisition (MS2)
- Raw data were Searched in Thermo Fisher Scientific's Compound Discoverer 3.2
- Identified features were then subset by requiring the delta mass to be between 5 ppm, Full Match annotation in at least 3 sources and feature name for highest quality identification

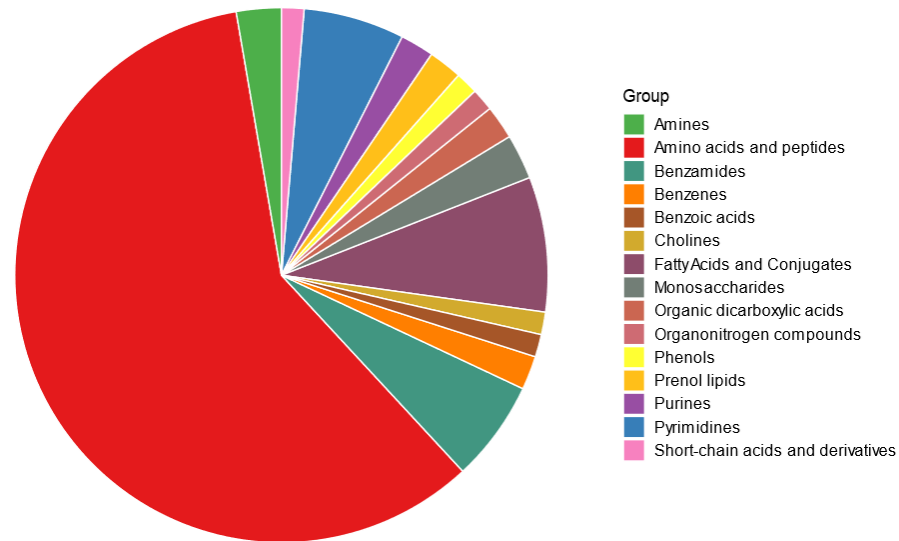

Enrichment Overview (top 25)

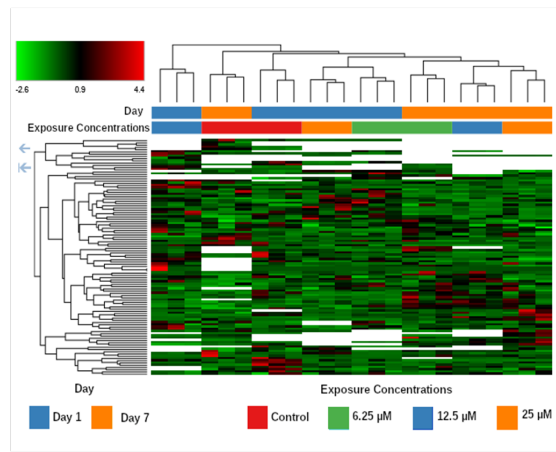
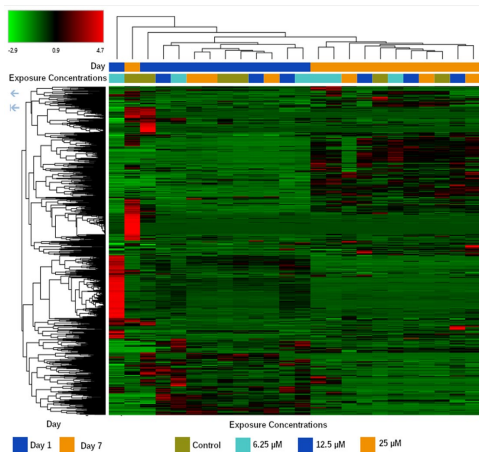
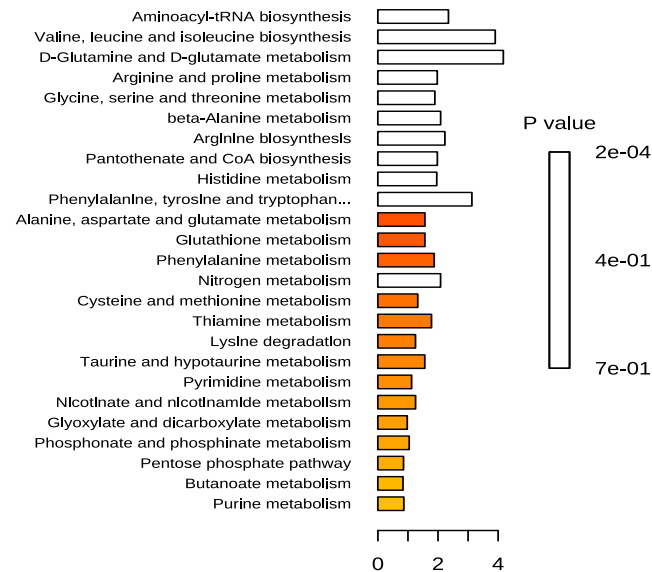



METABOLOMIC AND PROTEOMIC DYSFUNCTION



Inhibition of Choline Conversion to Phosphocholine Consistent with VX MOA

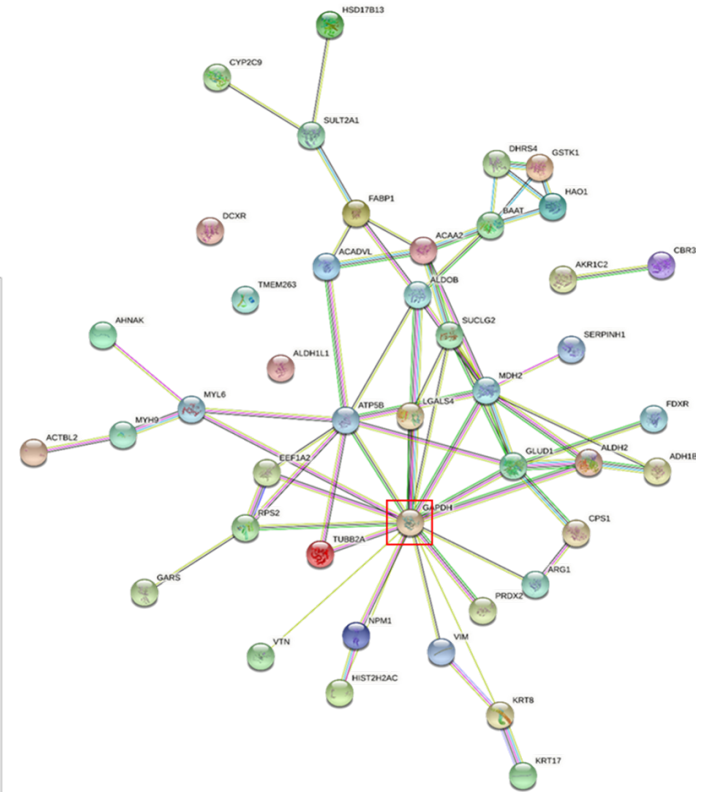
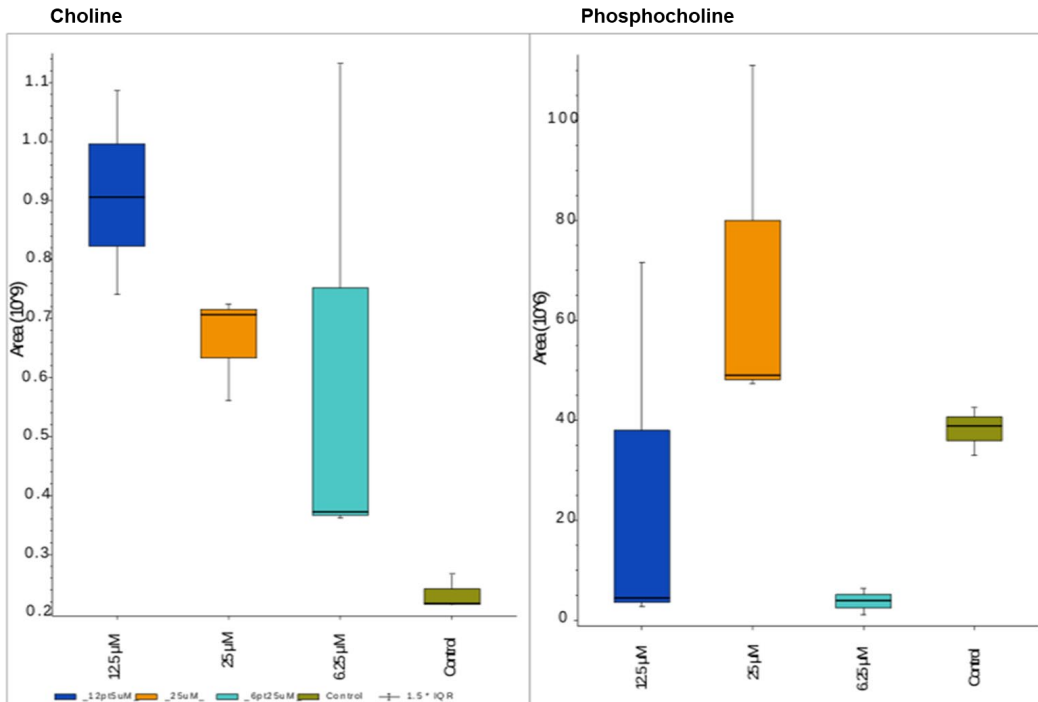

Recent literature regarding mechanism of action of VX indicates direct impacts on the TCA cycle. Performing a network analysis detailed an interconnection of the significantly changing (pval <= 0.5) proteins, centered on glyceraldehyde-3-phosphate dehydrogenase (boxed in red), an integral member in the glycolysis pathway



RNASEQ INDICATES ENERGETIC, INFLAMMATORY AND METABOLIC DYSREGULATION



PATHWAY	P-value	Q-value	NES
KEGG_GLYTATHIONE_METABOLISM	0.006	.330	1.69
HALLMARK REACTIVE OXYGEN SPECIES	0.018	.386	1.55
GOBP_CELLULAR RESPONSE TO AMMONIUM ION	0.025	.514	1.38
BIOCARTA_MITOCHONDRIA_PATHWAY	0.026	.380	1.69
HALLMARK FATTY ACID METABOLISM	0.051	.565	1.59
BIOCARTA_ETC_PATHWAY	0.064	.511	1.41
DNA-RNA_METABOLISM	0.071	.379	1.59
HALLMARK OXIDATIVE PHOSPHORYLATION	0.076	.452	1.51
HALLMARK INFLAMMATORY RESPONSE	.0990	.510	1.4
HALLMARK GLYCOLYSIS	0.103	.468	1.33
NITROGEN COMPOUND METABOLIC PROCESS	0.105	.387	1.48

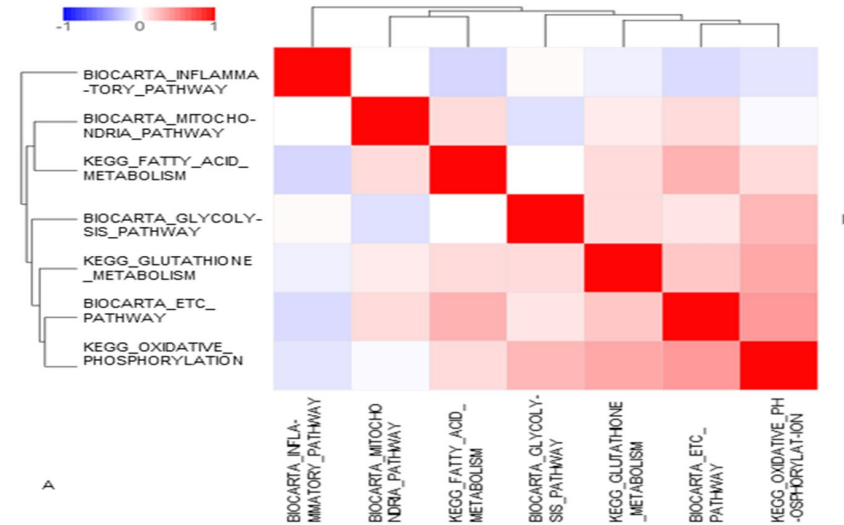

A

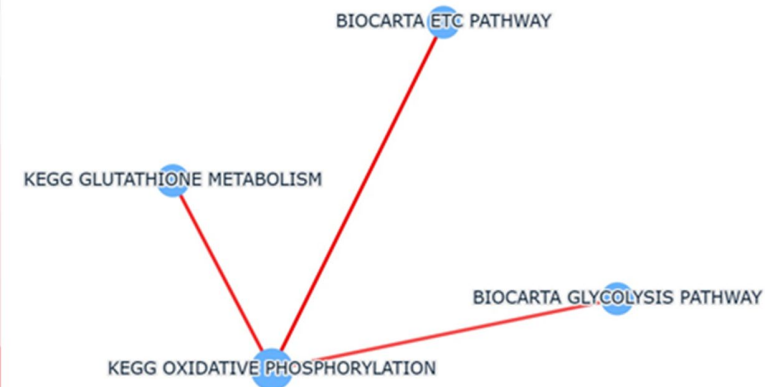



Filling in Human Health Data Gaps for PFAS Exposure in Liver and Kidney

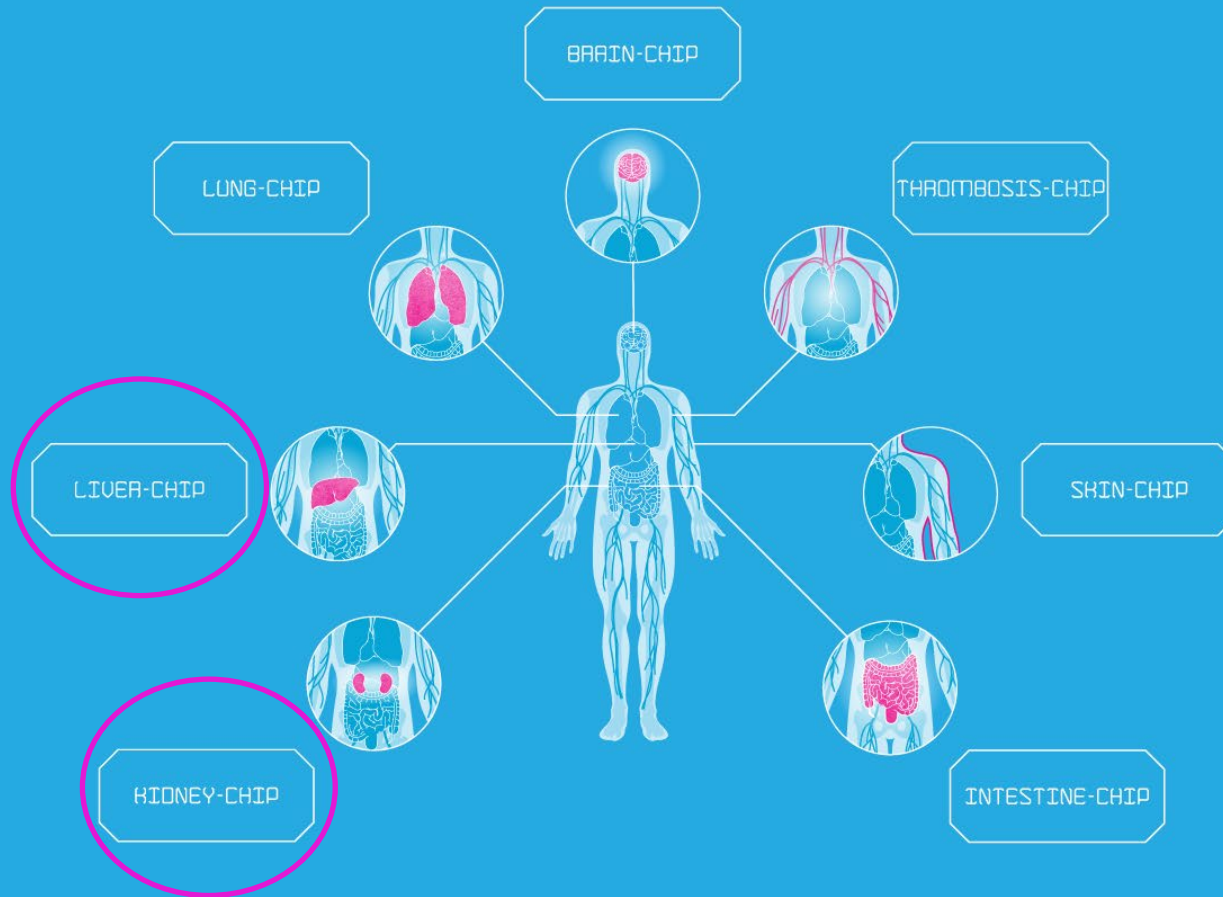



RENAL PROXIMAL TUBULE CHIP

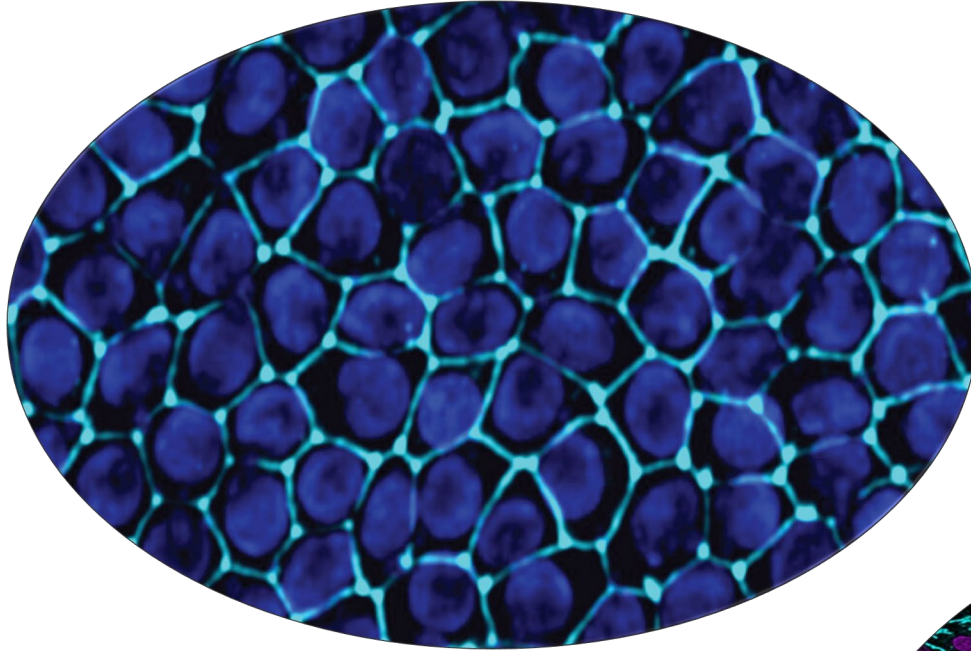

- Top layer of chip consists of human renal proximal tubule epithelial cells.
- Approximately 50,000 cells/chip.

- Bottom layer of chip consists of human renal microvascular endothelial cells.
- Approximately 40,000 cells/chip.

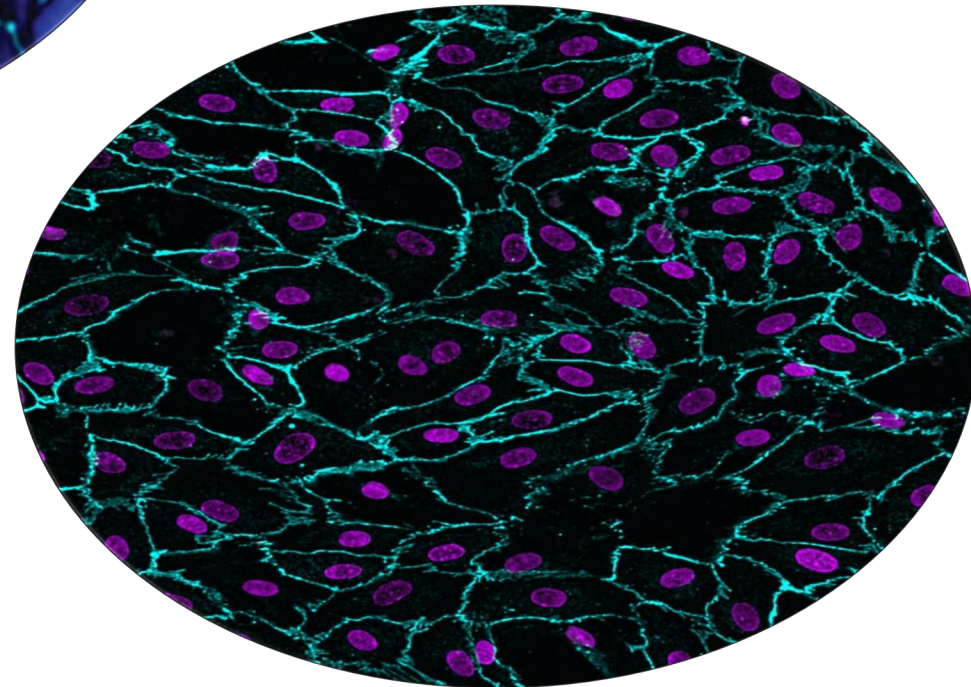



PFAS RETENTION IN MEDIUM EFFLUENT



PFOS Liver

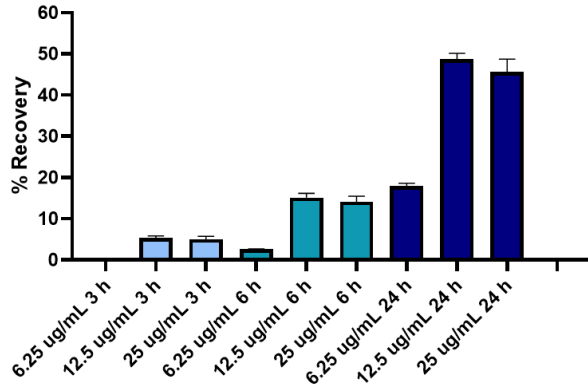

PFHxS Liver

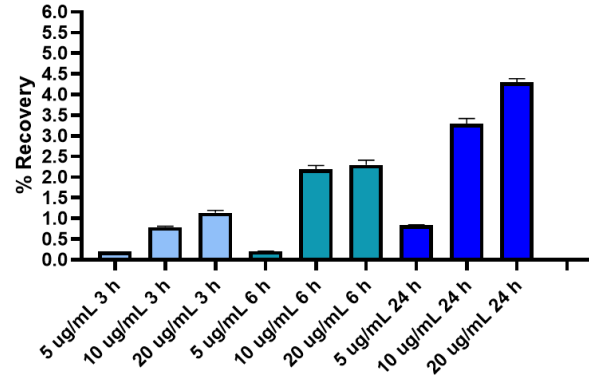

PFOS Kidney

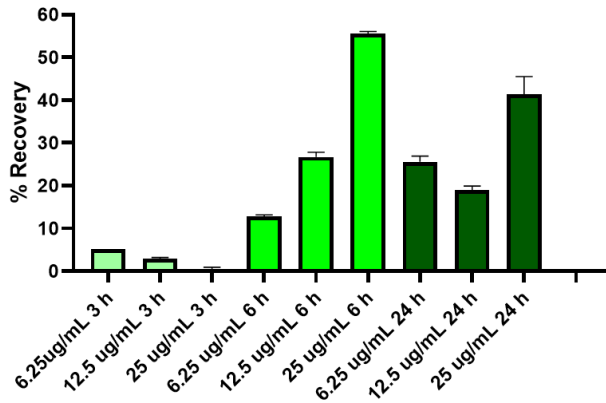

PFHxS Kidney

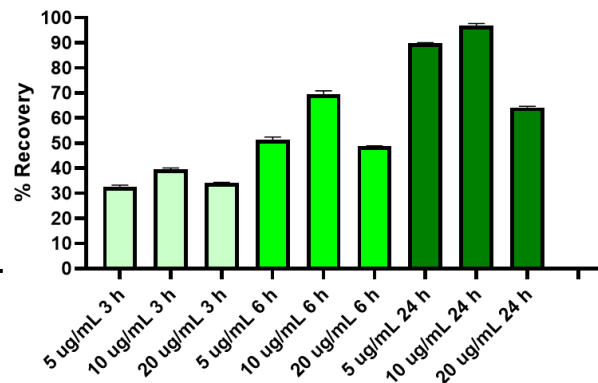

Liver: Both compounds were detected via LC/MS dose dependently, also increasing over time. More PFOS was detected than PFHxS, although PFOS was not detected up to highest concentration.

Kidney: More PFHxS was detected in kidney effluent (up to 100% at 10 ug/mL), however, there was a significant amount of PFOS detected after 6 hours. These data deviate from the other exposures where compound detection increased over time.



PFAS RETENTION IN CELL LYSATE



PFHxS

Kidney

Liver



PFOS

Kidney

Liver

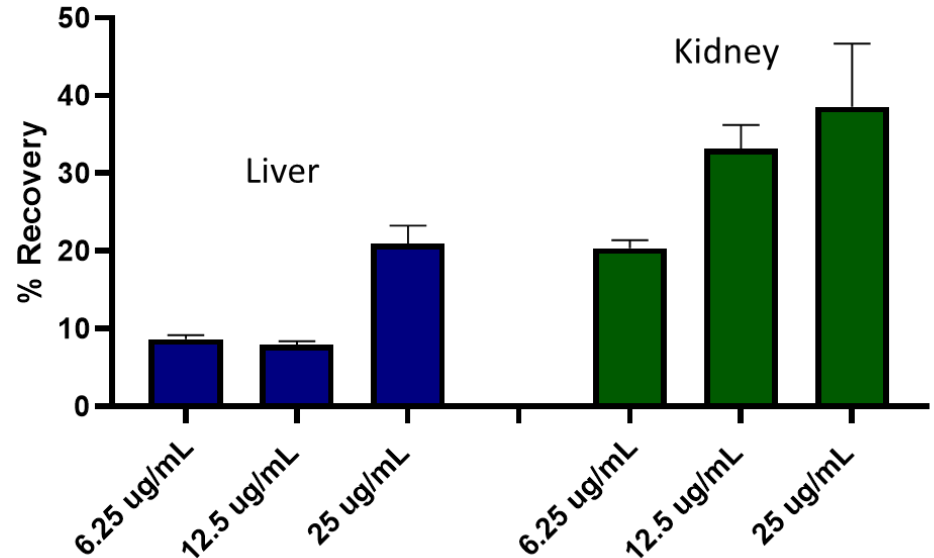

Epithelium was lysed from chips and analyzed via LC/MS for PFOS or PFHxS.

Less than 1% of PFHxS was detected in liver, while up to 20% of PFOS was detected at 25 ug/mL treated chips.

100% of the PFHxS at 10 ug/mL was detected in kidney lysates, while around 40% of PFOS retained in the 25 ug/mL treated chips.



PFOS/PFHXS AFFECTS PRODUCTION OF URIC ACID AND ROS/RNS

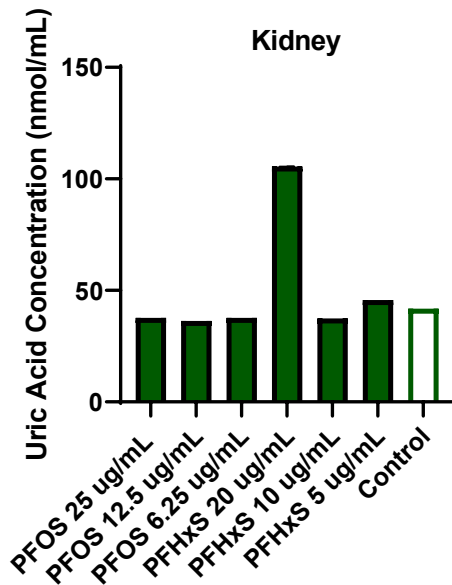
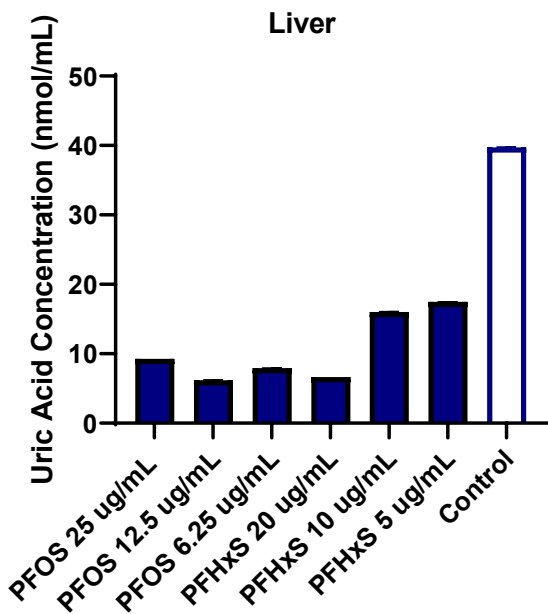

- Hyperuricemia, seen in the highest concentration of PFHxS tested in kidney chips, can cause the formation of urate, resulting in gout or kidney stones.
- A significant decrease in ROS/RNS was observed at 6 hours post exposure with both compounds in liver chips compared to the untreated control.

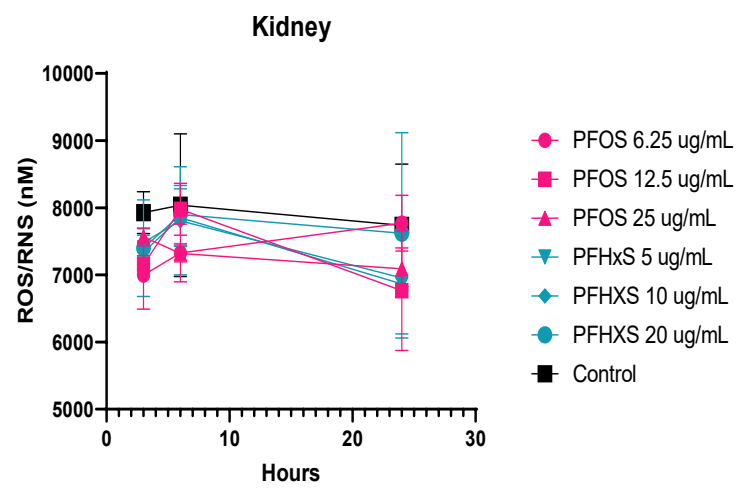
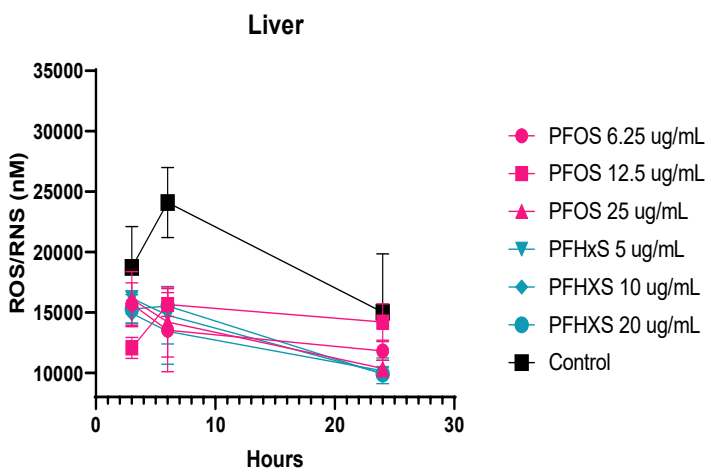



Identifying the Effects of SARS-CoV-2 in Lung Chip Models

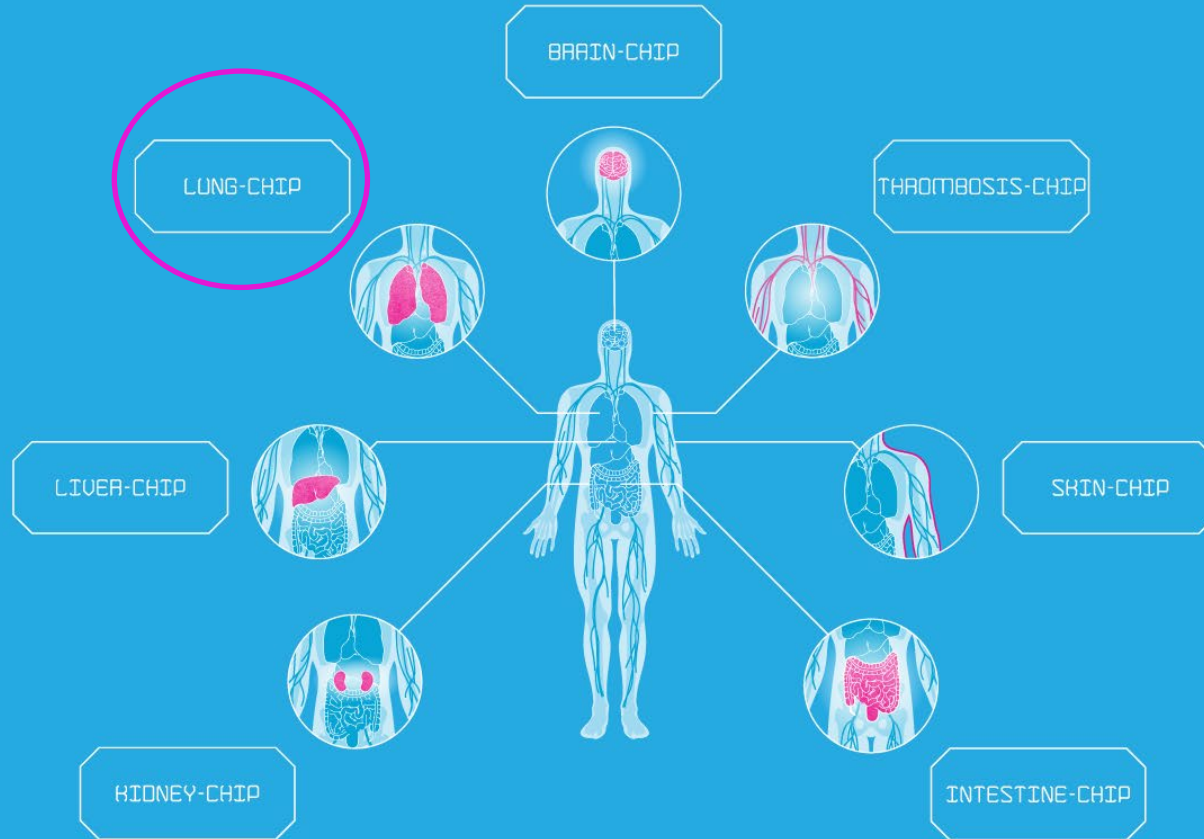



SARS-COV-2 INFECTION OF LUNG ALVEOLUS AND SMALL AIRWAY MPS

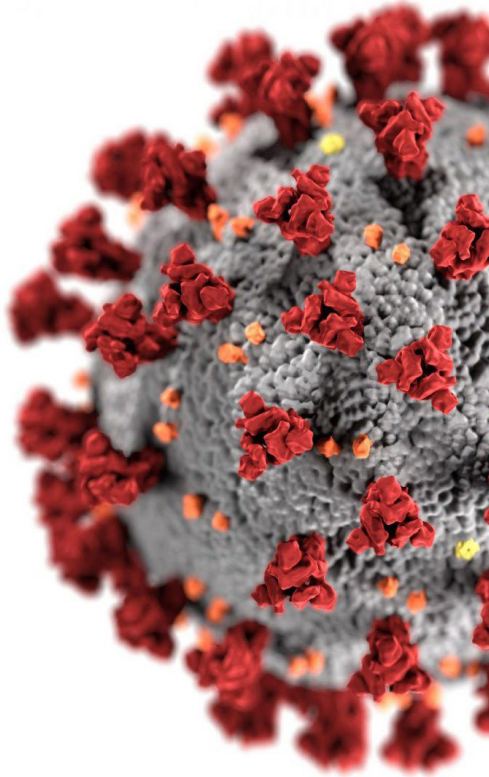

Reproduce viral entry, replication and release in a human differentiated primary alveolar model

Real-time monitoring following infection and assessment of variables such as infectious dose

Mechanistic inquiry using multi-omics approaches

Provide additional targets for prophylaxis, intervention and anti viral drug design



LUNG CHIP DEVELOPMENT



- **Deliverables:**
- Both lung systems are developed and were assessed for appropriate cell types.
- Infections in BSL3 complete, testing multiple infection concentrations and infection durations.

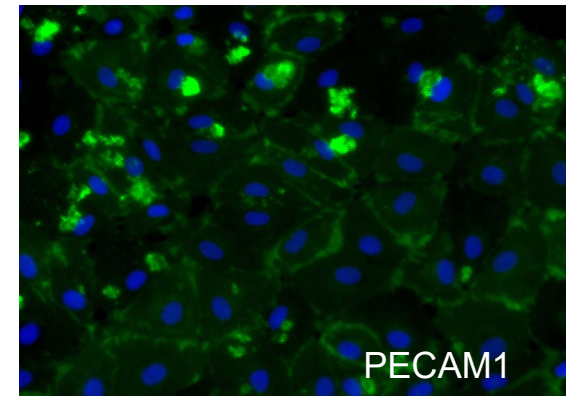
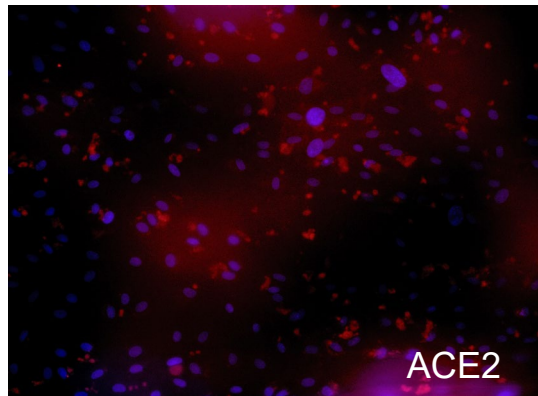
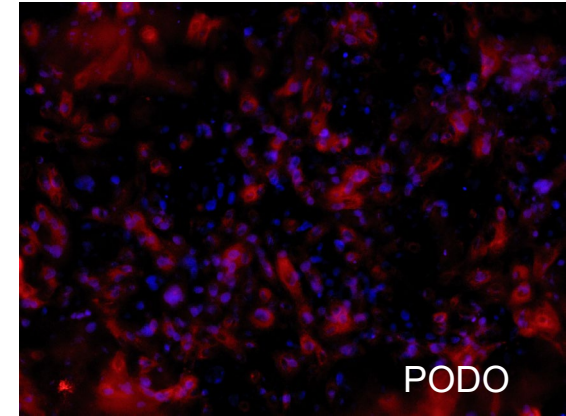
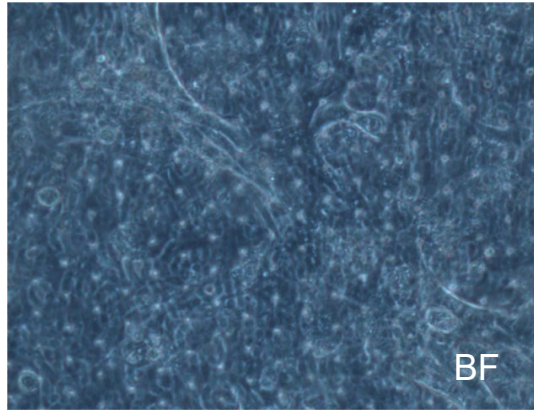

Analyses:

Proteomics/Transcriptomics – Intact proteoform and transcriptome analysis, Intelligent instrument acquisition, enriched data dependent acquisition, high-throughput/highly reproducible sample preparation techniques

Metabolomics – Machine learning driven feature detection, global metabolite system perturbation analysis, broad screening based on multiple chemometric profiles.



SARS-CoV-2 PROTEOMICS DATA



4180 high confident proteins identified

- Filtered for > 1 PSM and > 0 Unique peptides





DYSREGULATED CELLULAR PROCESSES COMPARED TO UNINFECTED CHIPS

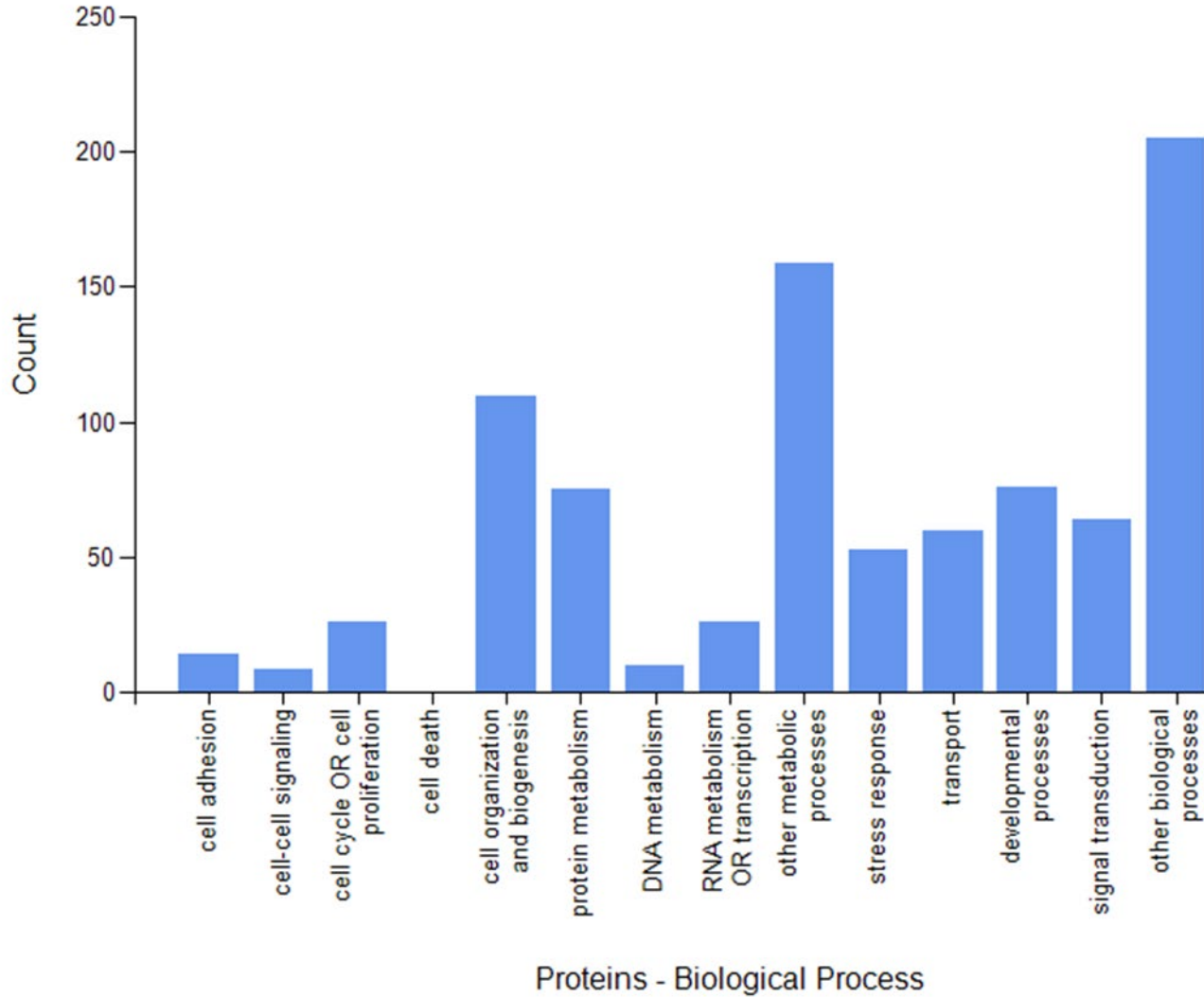



DYSREGULATED CELLULAR PROCESSES COMPARED TO UNINFECTED CHIPS

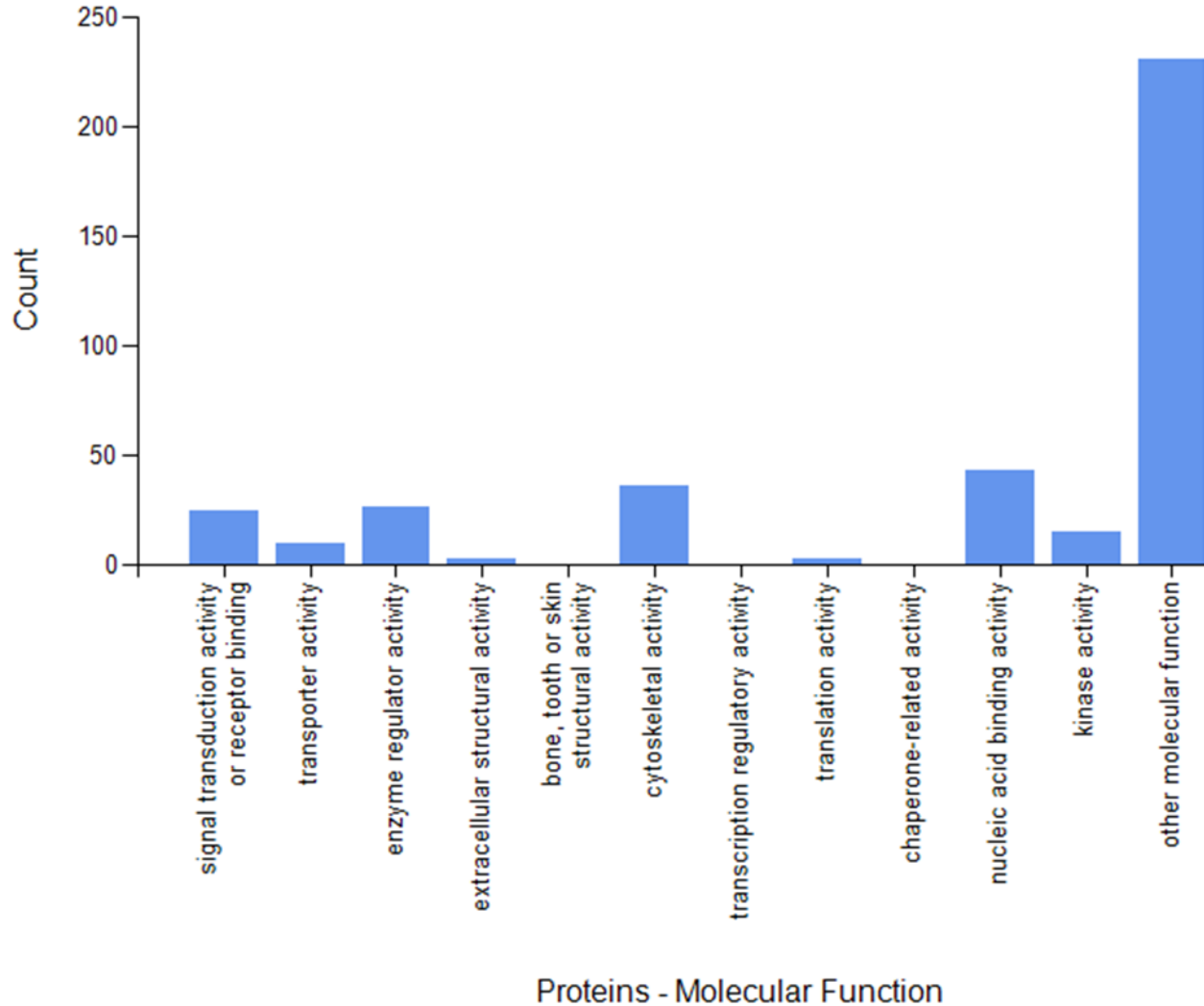



LUNG INFLAMMATORY RESPONSE 7 DAY INFECTION



Compliment C6

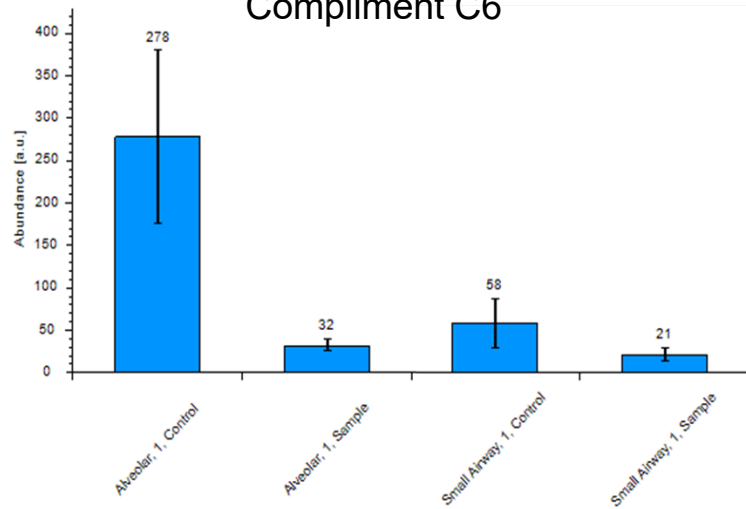

Cytokine Response

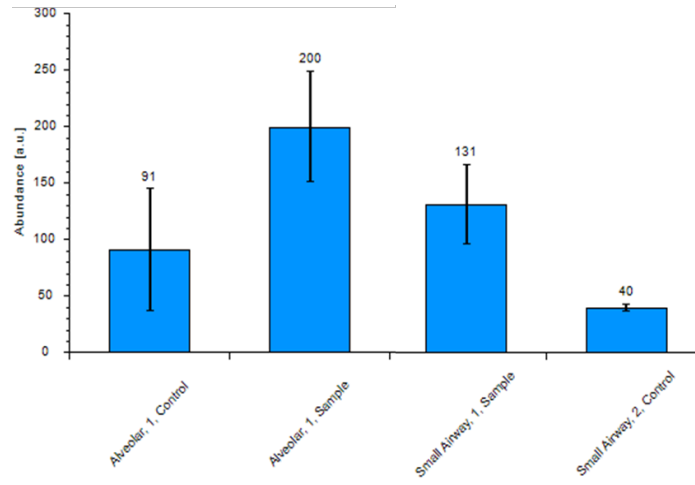

T-Cell Signaling

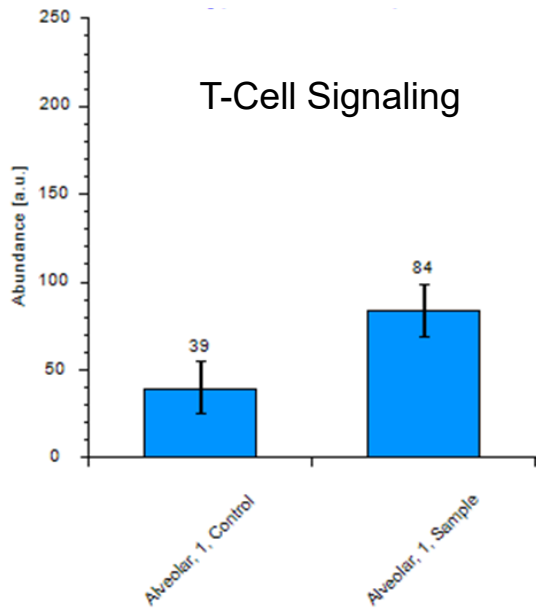

B-Cell Promotion

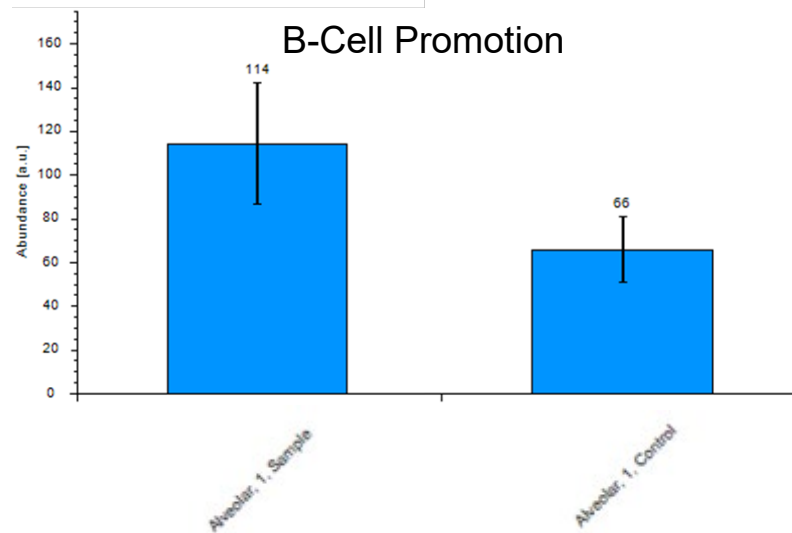



LUNG TISSUE DYSREGULATION

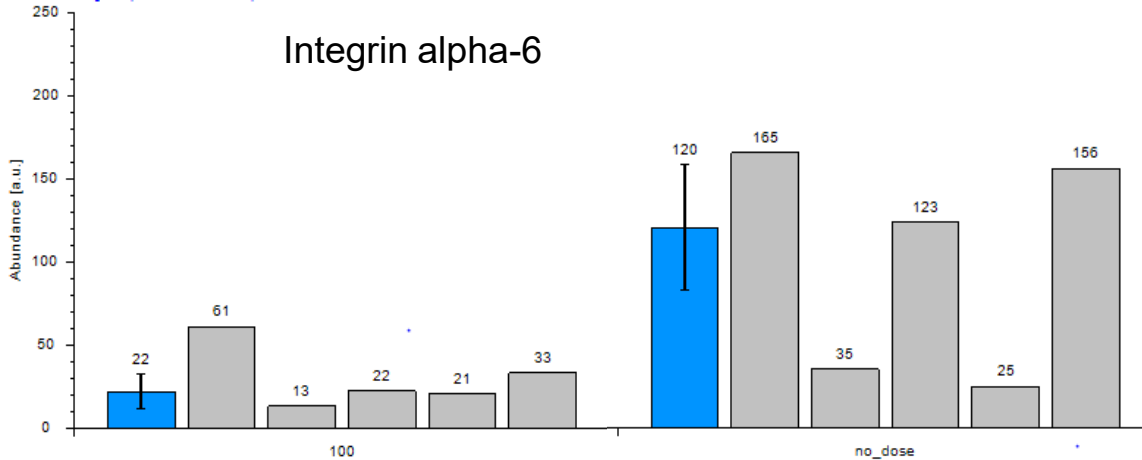

- Integrins are involved in cell growth, signaling, proliferation, apoptosis, and endothelial adhesion to ECM.

- IGFBPs serve as transporters for IGFs.
- Increase in IGF can lead to lung fibrosis.

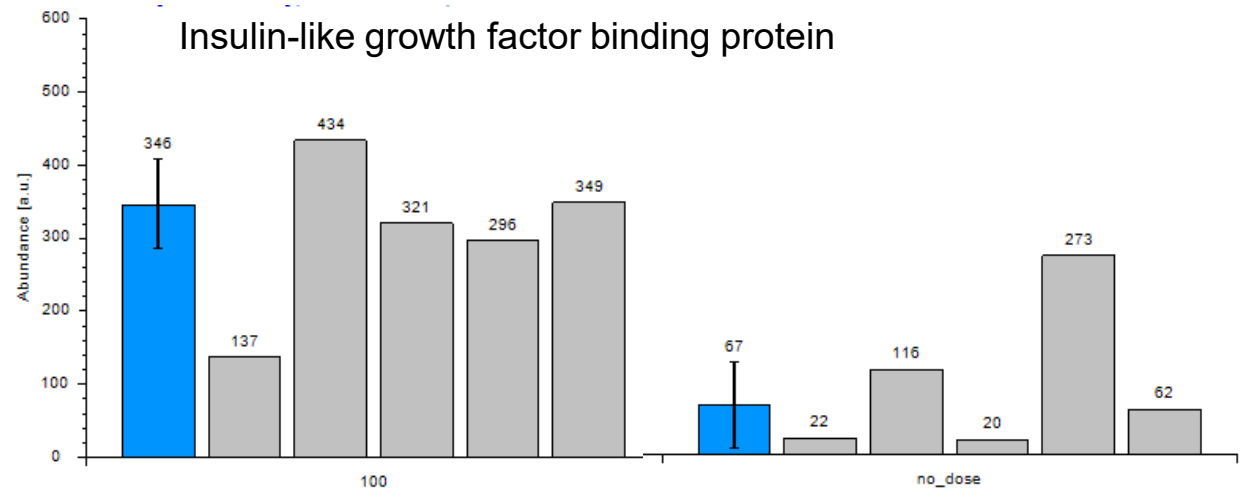



PECAM-1 EXPRESSION ENDOTHELIAL LAYER



Uninfected

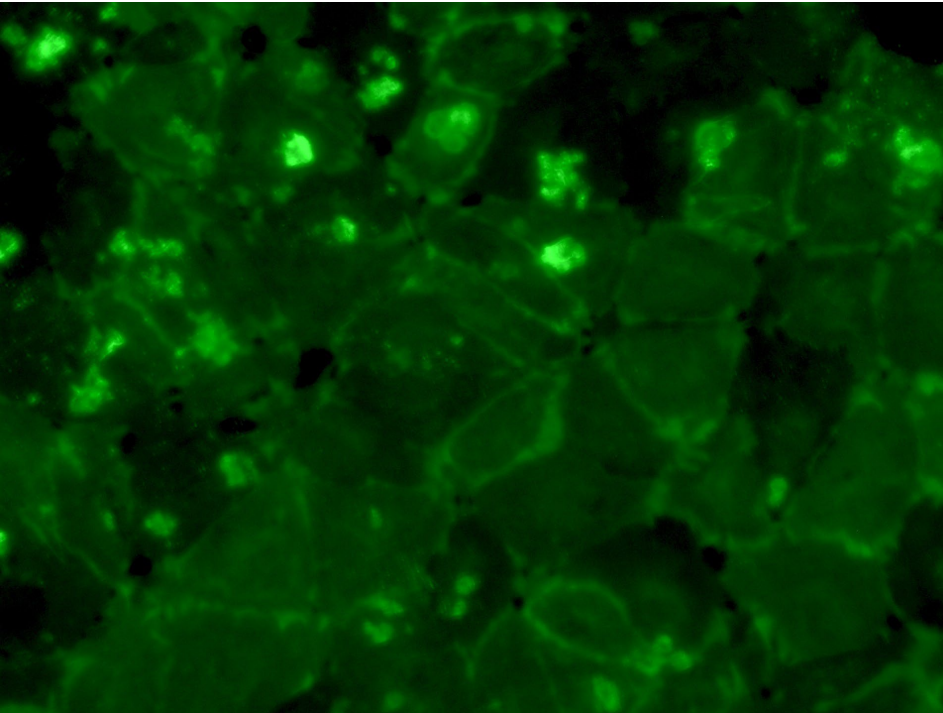

SARS-CoV-2 Infected

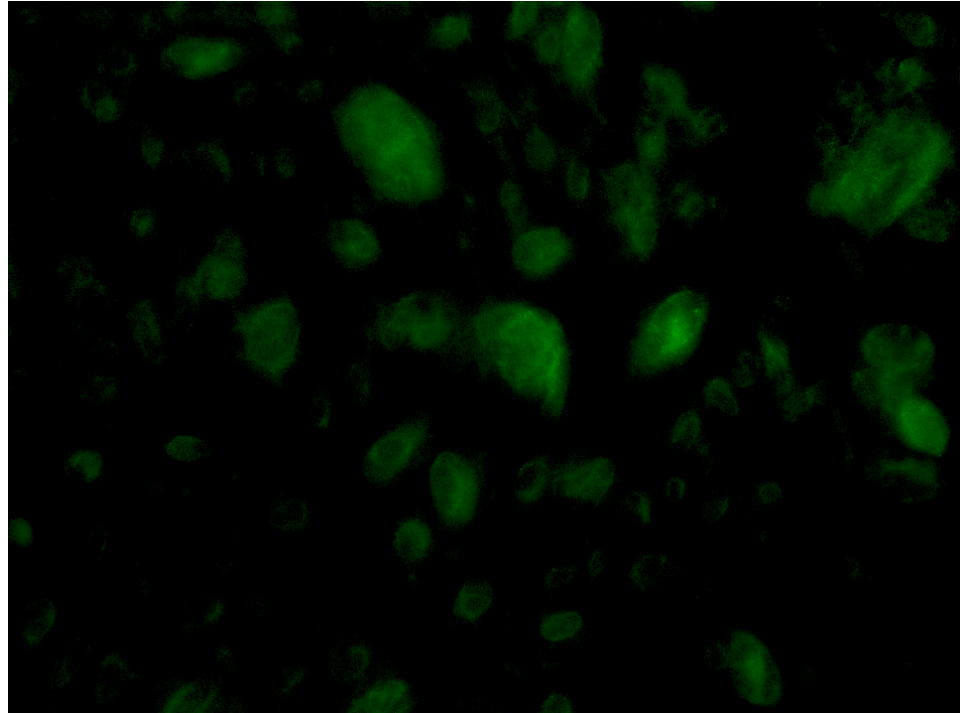

- Thacker V.V. et al, 2020, found that SARS-CoV-2 infections in lung chips resulted in endothelialitis and vascular damage.



ALVEOLUS DAY 7 POST INFECTION ENRICHMENT MAPPING (100 TCID50)



1	hsa01100	Metabolic pathways	1521	57	10.9	5.23	1e-11
2	hsa05022	Pathways of neurodegeneration	473	18	3.4	5.31	1.38e-08
3	hsa05020	Prion disease	272	13	1.9	6.67	1.09e-07
4	hsa05016	Huntington disease	308	12	2.2	5.43	2.86e-06
5	hsa05014	Amyotrophic lateral sclerosis	364	13	2.6	4.98	2.88e-06
6	hsa05010	Alzheimer disease	381	13	2.7	4.76	4.72e-06
7	hsa01240	Biosynthesis of cofactors	150	8	1.1	7.44	1.41e-05
8	hsa00230	Purine metabolism	125	7	0.9	7.81	3.56e-05
9	hsa05418	Fluid shear stress and atherosclerosis	134	7	1	7.29	5.55e-05
10	hsa05146	Amoebiasis	100	6	0.7	8.37	8.83e-05
11	hsa04217	Necroptosis	149	7	1.1	6.55	0.000108
12	hsa05415	Diabetic cardiomyopathy	202	8	1.4	5.52	0.000116
13	hsa05205	Proteoglycans in cancer	203	8	1.5	5.5	0.00012
14	hsa05012	Parkinson disease	268	9	1.9	4.68	0.000154
15	hsa00730	Thiamine metabolism	15	3	0.1	27.9	0.000156
16	hsa01230	Biosynthesis of amino acids	73	5	0.5	9.55	0.000186
17	hsa05208	Chemical carcinogenesis	224	8	1.6	4.98	0.000235
18	hsa00970	Aminoacyl-tRNA biosynthesis	44	4	0.3	12.7	0.000282
19	hsa00520	Amino sugar and nucleotide sugar metabolism	49	4	0.4	11.4	0.000427
20	hsa05200	Pathways in cancer	530	12	3.8	3.16	0.000515
21	hsa05017	Spinocerebellar ataxia	140	6	1	5.98	0.000547
22	hsa00480	Glutathione metabolism	58	4	0.4	9.62	0.000813
23	hsa00310	Lysine degradation	60	4	0.4	9.3	0.000924
24	hsa04218	Cellular senescence	159	6	1.1	5.26	0.00106
25	hsa04010	MAPK signaling pathway	294	8	2.1	3.8	0.00139
26	hsa00740	Riboflavin metabolism	8	2	0.1	34.9	0.0014
27	hsa01200	Carbon metabolism	115	5	0.8	6.06	0.00149
28	hsa05171	Coronavirus disease	232	7	1.7	4.21	0.00153
29	hsa00051	Fructose and mannose metabolism	32	3	0.2	13.1	0.00155
30	hsa04611	Platelet activation	126	5	0.9	5.54	0.00222
31	hsa04915	Estrogen signaling pathway	133	5	1	5.24	0.00281
32	hsa05130	Pathogenic Escherichia coli infection	195	6	1.4	4.29	0.00297
33	hsa00380	Tryptophan metabolism	41	3	0.3	10.2	0.00319



Infectability of Human BrainSphere Neurons Suggests Neurotropism of SARS-CoV-2

C. Korin Bullen^{#1}, Helena T. Hogberg^{#2}, Asli Bahadırli-Talbott¹, William R. Bishai¹, Thomas Hartung^{2,3,4}, Casey Keuthan⁵, Monika M. Looney¹, Andrew Pekosz⁴, J. Carolina Romero², Fenna C. M. Sillé^{2,6}, Peter Um¹ and Lena Smirnova^{2,#}

¹Johns Hopkins University, School of Medicine, Department of Medicine, Division of Infectious Diseases, Baltimore, MD, USA; ²Johns Hopkins University, Bloomberg School of Public Health, Center for Alternatives to Animal Testing (CAAT), Baltimore, MD, USA; ³CAAT-Europe, University of Konstanz, Konstanz, Germany; ⁴Johns Hopkins University, Bloomberg School of Public Health, Department of Molecular Microbiology and Immunology, Baltimore, MD, USA; ⁵Johns Hopkins University, Bloomberg School of Public Health, Department of Molecular Microbiology and Immunology, Baltimore, MD, USA; ⁶Johns Hopkins University, Bloomberg School of Public Health, Department of Molecular Microbiology and Immunology, Baltimore, MD, USA

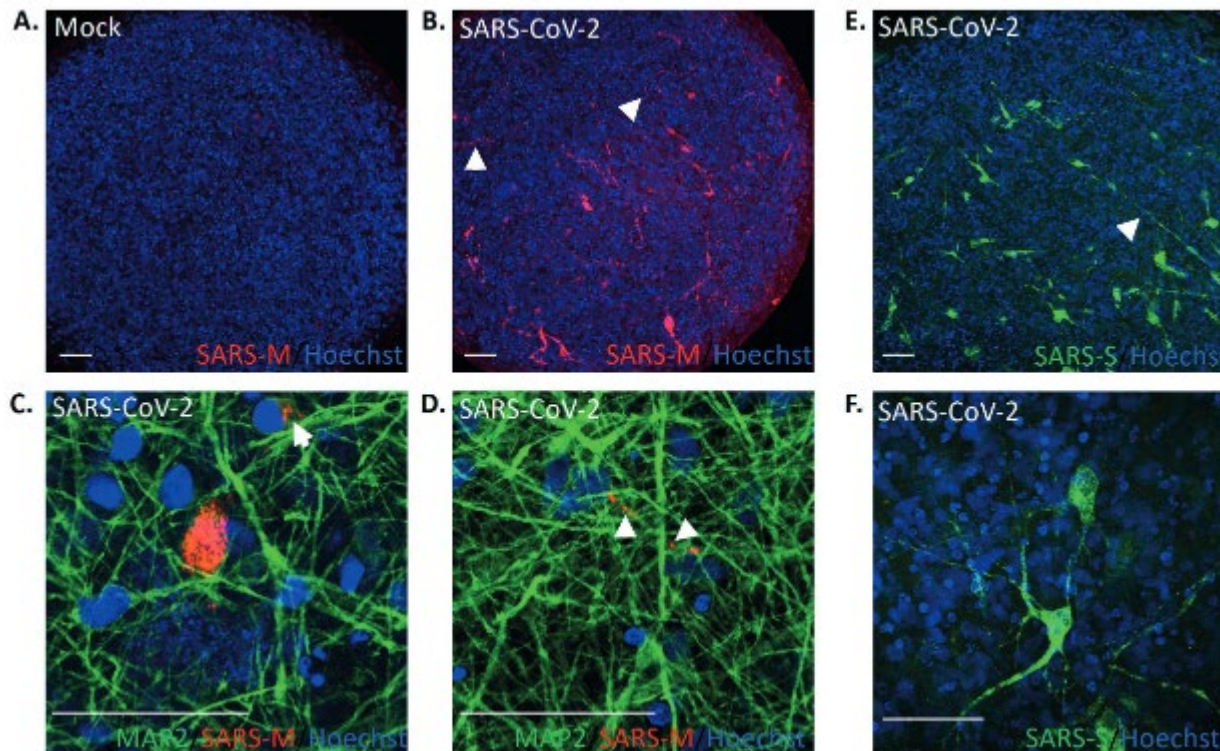



AEROSOL DELIVERY TO LUNG-CHIP

SLA/DLP 3D-Printers



Monochrome LCD



Laser Scanning



Micro SLA

3D-Printed Parts

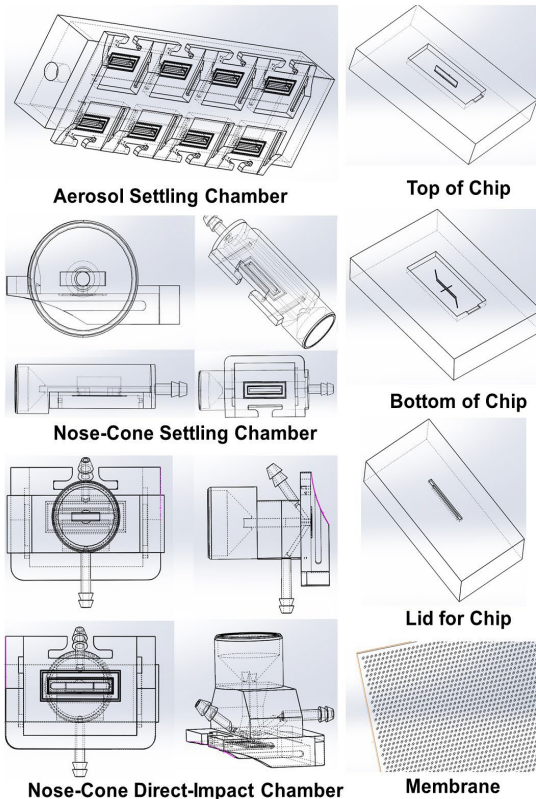

Aerosol Generating/Delivery System

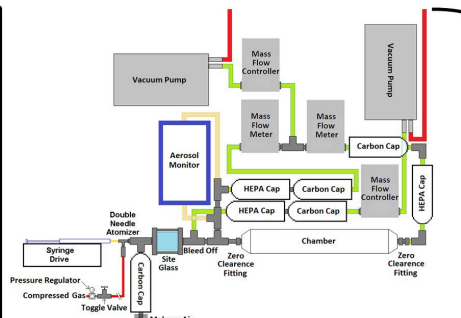

Aerosol Settling System

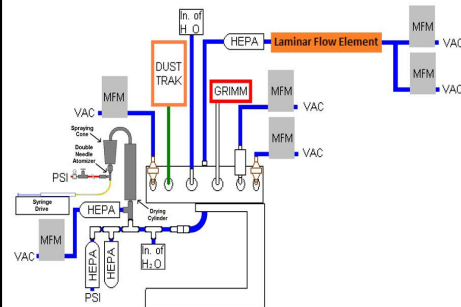

Nose-Cone Aerosol System

Aerosol Amendable Open- Top Lung-Chips

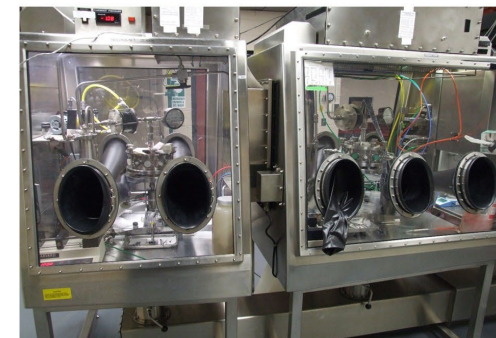
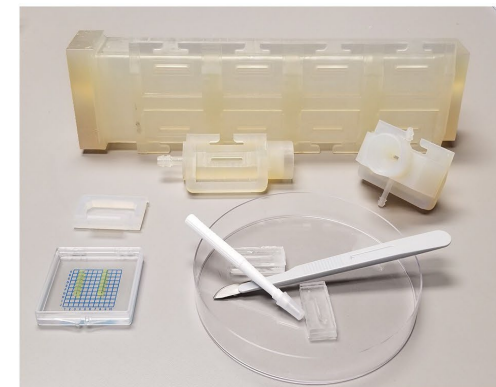



ACKNOWLEDGMENTS



Molecular Toxicology

Jennifer Horsmon

Dylan Fudge

Priscilla Lee

Kyle Glover

BioDefense

Dan Angelini

Liz Dhummakupt

Conor Jenkins

Jennifer Sekowski

Todd Sickler

Amber Pugh

Maria Arevalo

